

IDENTIFICATION OF CHRONOGRAPH

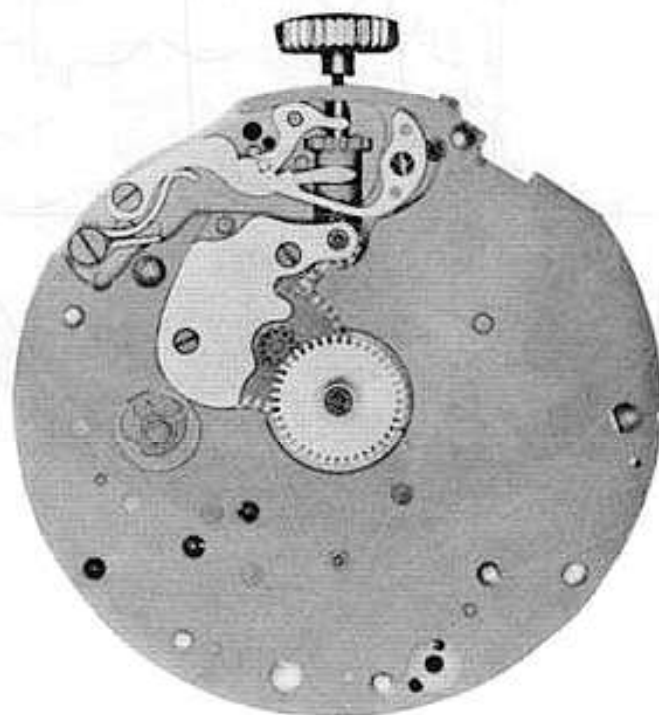

14L



VALJOUX

CAL. 84



ESEMBL-O-GRAF

THE WORLD'S FIRST FULLY
ILLUSTRATED TEXT BOOK
ON
CHRONOGRAPH REPAIRING
AND ADJUSTING

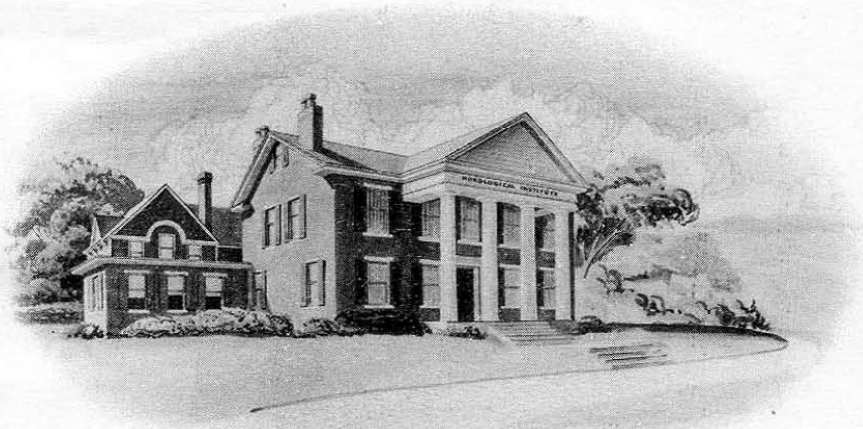

BY
William O. Smith, Sr.
PRESIDENT AND TECHNICAL DIRECTOR
AND
William O. Smith, Jr.
CHIEF ENGINEER, RESEARCH LABORATORIES

WESTERN PENNSYLVANIA HOROLOGICAL INSTITUTE, INC.
PITTSBURGH, PENNSYLVANIA

INSTRUCTIONS

For use of book

DISASSEMBLY OF THE CHRONOGRAPH MECHANISM:

1. Study the isometric drawing at top of page 1-A. The isometric drawing was made for the following purposes:
 - A. It helps to identify the part to be removed.
 - B. This drawing aids in pointing out certain locations on the part that are mentioned in the oiling procedure.
 - C. The text refers to certain points on the part. These points are shown in the isometric drawing. This should aid you in finding the exact location on the part that is described in the text.
 - D. It helps you to know the shape of the part in case a new part has to be made.
2. At the bottom of the page 1-A is a photograph of a chronograph. In this photograph is the same part painted in black. The part is in its exact location that this part occupies in the watch. Find this location in the watch.
3. Read the disassembly procedure and the hazards in disassembly on page 1 in this book.
4. Remove this part in the same procedure as described in the text.
5. A very important item in disassembling a chronograph is keeping the screws in order, much time will be lost in putting the chronograph together if screws are mixed up. This means you have to hunt for each screw, sometimes trying three or four screws before finding the correct one. It cannot be stressed too strongly that care should be taken so that screws are not mixed up. The system that we advise for beginners, is to replace each individual screw after each part is removed. This naturally eliminates the hazard of mixing up the screws and will save you much time in the end. Do this at least until you become so thoroughly familiar with the chronograph that you no longer feel it is necessary.
6. Continue to follow this procedure throughout the book and disassemble each part until the last part of the chronograph is removed.

ASSEMBLY OF THE CHRONOGRAPH MECHANISM:

7. When you are ready to assemble the chronograph mechanism, study the isometric drawing on the last part in this book. This drawing should aid you in identifying the part to be assembled.
8. At the bottom of this page is a photograph of a chronograph. In this photograph is the same part painted in black. The part is in its exact location that this part occupies in the watch.
9. Read the assembly procedure and the hazards in assembling for the last part in this book. (Continued on next page)

INSTRUCTIONS (Continued)

10. Replace the part in its exact location as shown in photograph, using the procedure as described in the text.

11. After you find the correct location for this part in the watch, read the oiling procedure for this part. The oiling procedure for this part is located underneath the isometric drawing. It is best to read the oiling procedure before you put each part in place as there are certain parts that must be oiled immediately as it may prove difficult to oil them later.

12. Replace the screw that holds this part in place. Of course, the screws should be kept in order as we advised above, but if the screws are not in order or the watch was received with screws mixed up, you will find a screw drawn for each part that requires a screw at the bottom of the text page.

13. After replacing this part, replace the next part, etc., until the last part is replaced, which will be part No. 1. Each part should be replaced using the same procedure as described in the text.

(Naturally, the assembly of the chronograph is exactly the reverse of the disassembly)

14. After disassembling and assembling the chronograph mechanism, start on page 1 and read the function of this part. After reading the function of this part, continue to read the function of each part throughout the book. Study each part, one at a time. This text should help you to understand more fully the purpose of each part in the chronograph mechanism.

15. Now put movement in its case with dial on, then replace hands.

16. Study the text on functional results in this book, and check the chronograph mechanism as described in this text.

NOMENCLATURE OF PART FOR CHRONOGRAPH MECHANISM

17. After you have become familiar with the chronograph mechanism, you can disassemble and assemble the chronograph by using the nomenclature of parts as a guide. This makes it possible for you to use a procedure without going through each page in the book.

18. ADJUSTMENT OF ECCENTRIC STUDS:

Read the text on adjustment of eccentric studs, this text should be read in reference to the eccentric stud picture. Now adjust each eccentric stud one at a time in the watch, as described in the text. Use the picture to show you the position of these studs.

19. On each page in this book the part number and the page number are the same. This makes it convenient for the reader and eliminates any confusion.

IDENTIFYING A CHRONOGRAPH OR STOP WATCH

The chronograph and stop watch are very similar in appearance in many respects, but there is a difference which will enable you to distinguish the chronograph from the stop watch.

The chronograph is a watch having at least one supplementary hand in addition to the regular hour, minute, and second hand which can be started, stopped or returned to zero at will. Thus the chronograph can be used as a regular timekeeping watch and may also be used in registering observations.

The stop watch is a watch which has only the necessary hands to register an observation, the hour, minute, and seconds hand being omitted. The stop watch is not used to indicate the time of day, but only to register the length of observations.

The stop watch is divided into two categories, the stop watch in which the balance wheel is continually in motion and the stop watch in which the balance wheel is in motion only during the actual timing of observations.

The advantage in the latter type is that the watch is running only during the actual timing operation. Thus there is less wear to the stop watch and the mainspring does not have to be wound so often. This is especially true in the stop watch which has a very rapid oscillation of the balance. The stop watch by altering the hairspring and balance wheel to increase the oscillation of the balance can be made to register $1/30$, $1/50$, or even $1/100$ of a second. This increase in the oscillation of the balance in the stop watch is possible because the balance wheel is in motion only during the actual timing operation and the watch does not indicate the time of day.

The chronograph is designed to register the time correct to $1/5$ of a second. It would be difficult to make a chronograph register correctly to less than $1/5$ of a second, as the rapid oscillation of the balance would require too large a mainspring to run the watch for a twenty-four hour period, and the hour and minute hand would have to be geared down tremendously to keep the correct time.

The chronograph usually embodies the basic principles by which the stop watch performs its function, and to anyone familiar with the functions of the various parts of a chronograph should have no trouble understanding stop watch mechanism.

NOMENCLATURE OF PARTS FOR CHRONOGRAPH MECHANISM

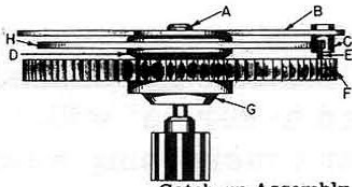

Catch-up Assembly
Assembly No. 1

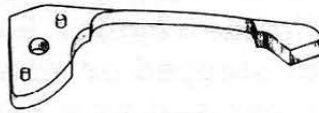

Minute register pawl
Assembly No. 2

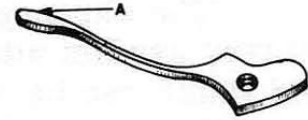

Chronograph Pivoted Detent
Spring Assembly No. 3

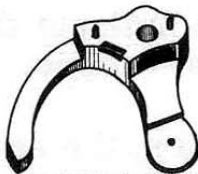

Chronograph Pivoted Detent
Bridge Assembly No. 4

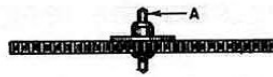

Intermediary Wheel
Assembly No. 5



Chronograph Pivoted
Detent Assembly No. 6

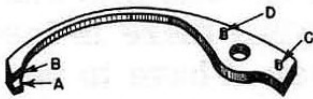

Actuating Detent Lever
Spring Assembly No. 7



Reversing Joint Hook
Assembly No. 8

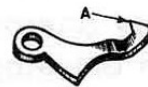

Joint Hook Assembly No. 9



Actuating Detent Lever
Assembly No. 10

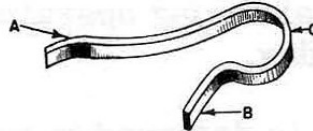

Catch-up Push Piece
Spring Assembly No. 11

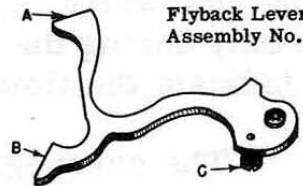

Flyback Lever
Assembly No. 12



Flyback Lever Spring
Assembly No. 13

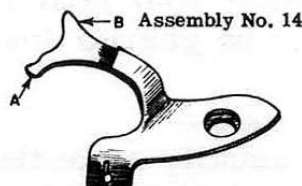

Catch-up Push Piece
Assembly No. 14

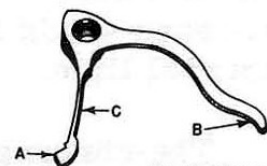

Brake Lever
Assembly No. 15

Continued on next page

NOMENCLATURE OF PARTS FOR CHRONOGRAPH MECHANISM

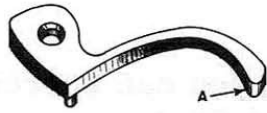

Brake Lever Spring
Assembly No. 16

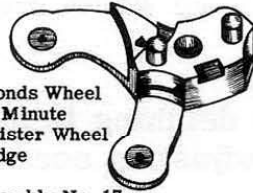

Seconds Wheel
and Minute
Register Wheel
Bridge
Assembly No. 17

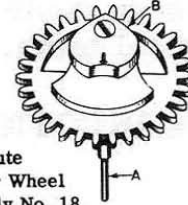

Minute
Register Wheel
Assembly No. 18

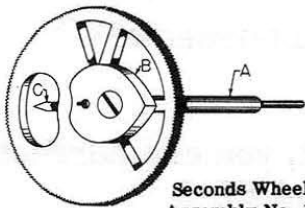

Seconds Wheel
Assembly No. 19



Seconds Wheel Tension
Spring Assembly No. 20

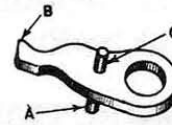

Minute Register Wheel
Stop Lever Assembly No. 21

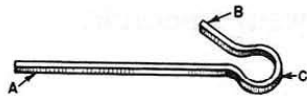

Minute Register Wheel Stop
Lever Spring Assembly No. 22



Intermittent Lever and Wheel
Assembly Spring Assembly No. 23

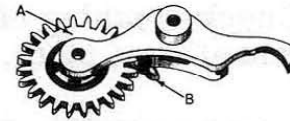

Intermittent Lever and Wheel
Assembly Assembly No. 24



Castle Wheel Pawl
Assembly No. 25

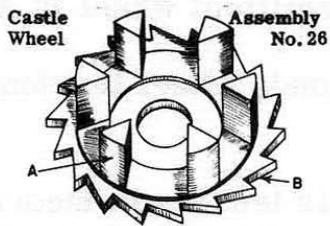

Castle
Wheel
Assembly
No. 26



Sweep Second Hand

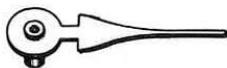

Minute Register Hand

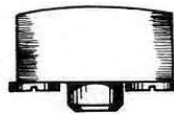

Chronograph Button



Chronograph
Button

ADJUSTING ECCENTRIC STUDS - THINGS TO CHECK

Listed below are a number of depthings and adjustments controlled by the eccentric studs:

1. Check depthing of catch-up wheel teeth with the intermediary wheel teeth.

CORRECTION: If this depthing is incorrect, you can correct it by adjusting eccentric stud ES-1.

REFERENCE: Catch-up wheel is Assembly 1.
Intermediary wheel is Assembly 5.

2. Check depthing of seconds wheel teeth with intermediary wheel teeth.

CORRECTION: If this depthing is incorrect, you can correct it by adjusting eccentric stud ES-2.

REFERENCE: Seconds wheel is Assembly 19.
Intermediary wheel is Assembly 5.

3. Check depthing of intermittent wheel teeth with seconds wheel dart tooth.

CORRECTION: If this depthing is incorrect, you can correct it by adjusting eccentric stud ES-3

REFERENCE: Seconds wheel dart tooth is Assembly 19-C
Intermittent wheel is Assembly 24-A

4. Check tension of seconds wheel tension spring on seconds wheel.

CORRECTION: If this tension is incorrect, you can correct it by adjusting screw AJ-1.

REFERENCE: Seconds wheel tension spring is Assembly 20.
Seconds wheel is Assembly 19.

ADJUSTING ECCENTRIC STUDS

DO NOT REMOVE THESE STUDS

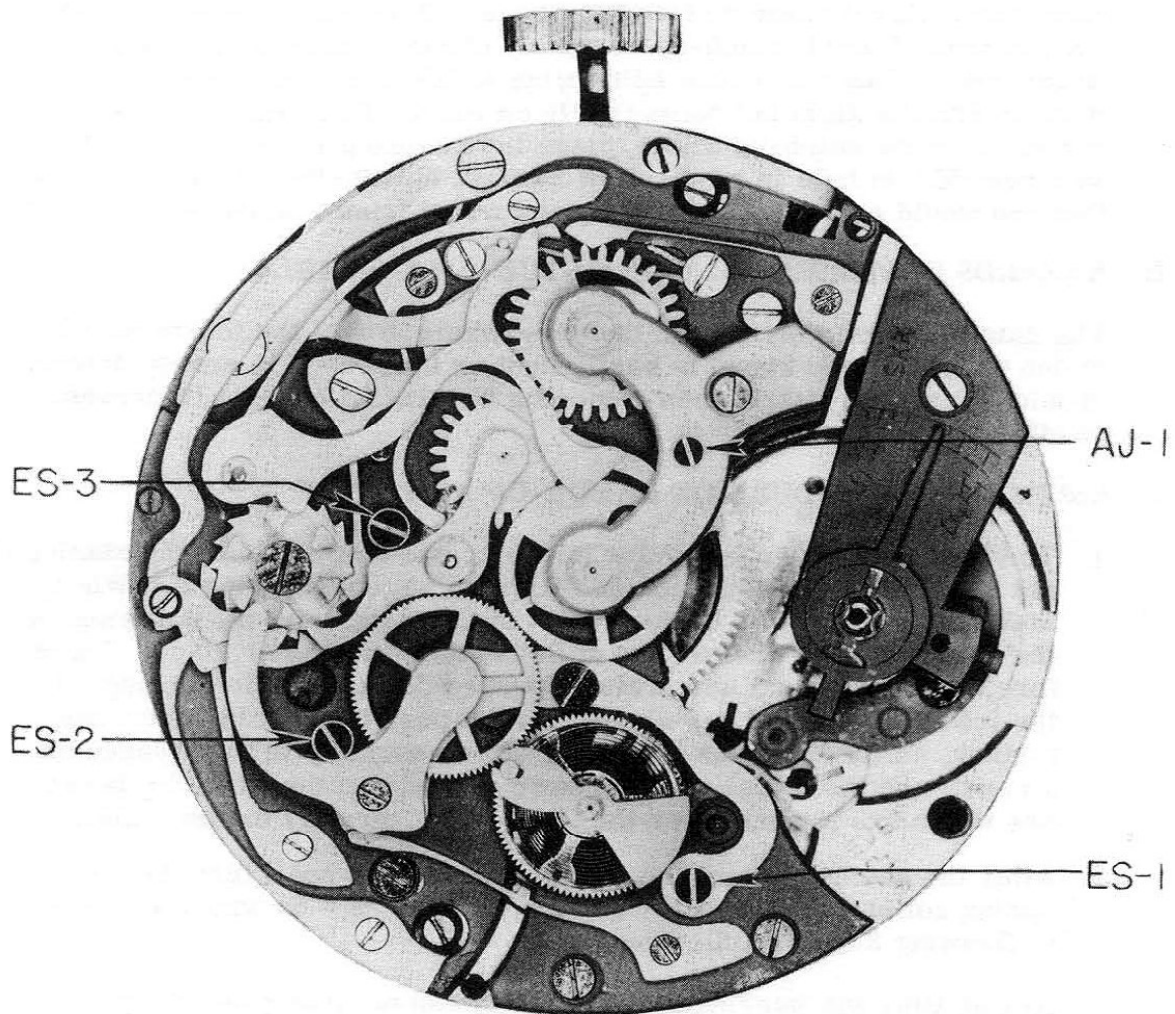

CAUTION

In disassembling or assembling chronograph it is a good policy not to turn eccentric studs. These eccentric studs are used to adjust one part to another and naturally in turning these studs you will lose the desired adjustment of the chronograph mechanism which will cause the chronograph to function incorrectly. Another reason for not turning these studs unless it is necessary is that they soon become loose and will not hold the desired adjustment.

PART NO. 1

A. DISASSEMBLY PROCEDURE OF CATCH-UP ASSEMBLY:

The catch-up assembly is removed by removing the bushing "A" from the long pivot on the fourth wheel pinion. This bushing fits friction tight on this pivot and is removed with two small thin blade screw-drivers. These screw-drivers are placed opposite each other between the collet "D" of catch-up hairspring and the underside of bushing "A". One screw-driver is turned clockwise while the other is turned counter-clockwise. (Illustration on following page - Drawing 2.) When bushing "A" is free of pivot, catch-up assembly can be removed by lifting finger "B". This will cause hairspring to lift catch-up wheel "F", as it is not friction tight but turns freely on pivot. To remove the hairspring from the catch-up wheel, place the catch-up wheel on an anvil with hub "G" in hole in anvil. Now remove hairspring in same manner that you would remove a hairspring and collet from a balance wheel.

B. HAZARDS IN DISASSEMBLY OF CATCH-UP ASSEMBLY:

The catch-up assembly fits on the very small pivot of the fourth wheel pinion which, as you know, is easily bent or broken. The screw-drivers should be carefully used when removing bushing from pivot to prevent bending of fourth wheel pivot.

C. ASSEMBLY PROCEDURE OF CATCH-UP ASSEMBLY:

1. To place the hairspring on the catch-up wheel, the use of the staking set is advised. (Illustration on following page - Drawing 3.) When staking the wheel, the bushing "A" in the finger will hit the jewel in the catch-up wheel before the collet is down in proper place. Therefore, the punch must be carefully pushed down until the bushing hits the jewel in the catch-up wheel. Do not push the bushing down any further, as it may break the jewel. The assembly is then placed on an anvil and the collet pressed down entirely on the wheel by tweezers which are placed under the finger "B" directly on the collet.
2. After the catch-up hairspring is staked to the wheel, turn the hairspring collet until the stud "C" touches pin "E" on wheel as shown in Drawing 3 on the following page.
3. At this time the intermediary wheel should be disengaged from the seconds wheel and the pallet fork should hold the watch train stationary. The balance assembly should not be in the watch.
4. Now place the catch-up wheel on the long pivot of the fourth wheel and lightly press the bushing "A" in finger "B" down on the long pivot. Drawing 1 shows the correct position of stud "C" and pin "E" in relation to each other.
5. Now to add the proper tension to the catch-up spring for it to function properly, turn the catch-up wheel clockwise (while holding

(Continued on next page)

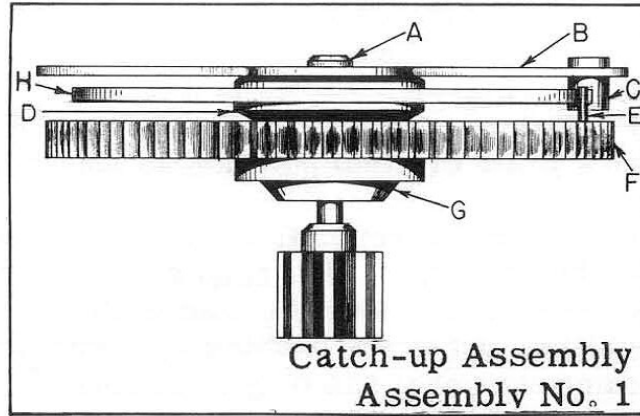

OILING

The catch-up assembly should not be oiled.

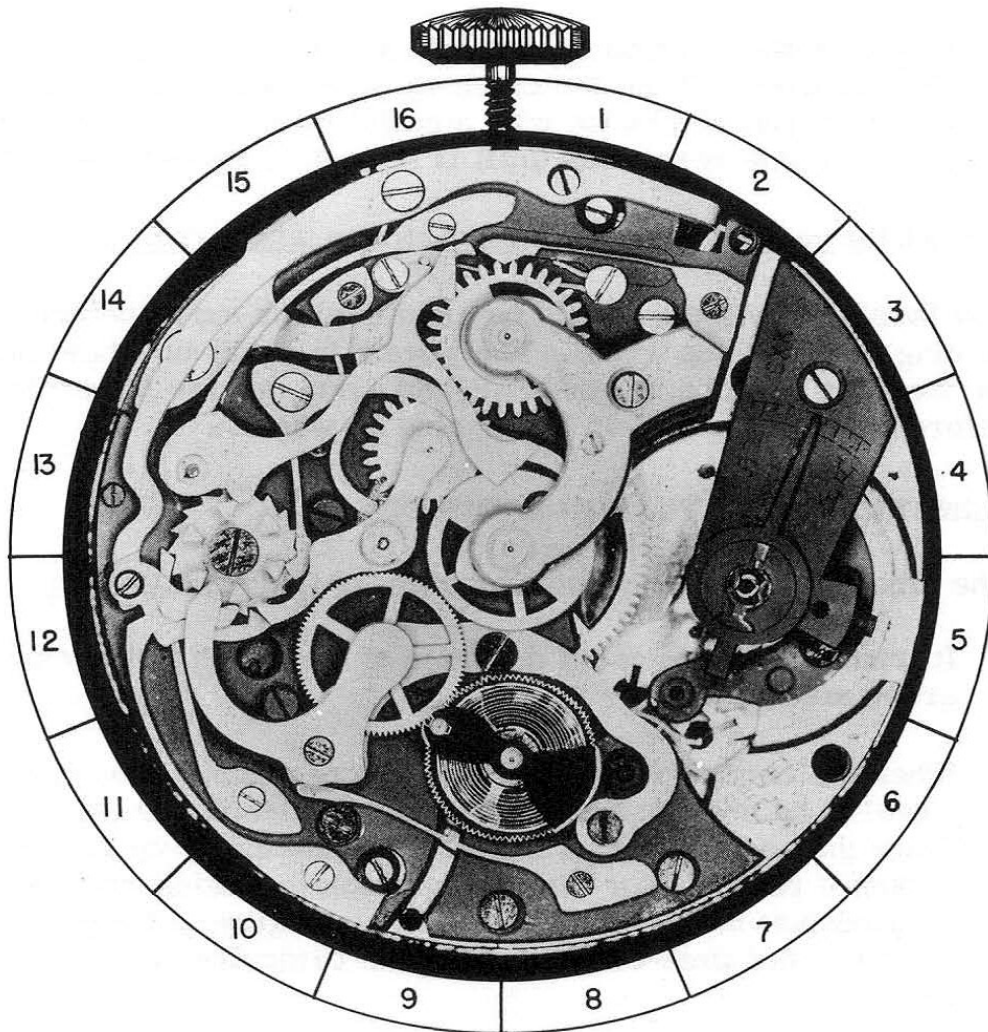

1-A

PART NO. 1
(Continued)

finger "B" stationary) until the pin "E" has made one revolution and back to its original position as shown in Drawing 1.

6. To make one complete revolution clockwise, the pin "E" must pass under the stud "C". The finger must be slightly lifted to permit the pin to pass under the stud in finger. With the pin in correct position, press the bushing in finger down on long pivot until the catch-up wheel has proper endshake.

Another method of adding proper tension on the catch-up spring:

Replace the catch-up assembly on the long pivot of the fourth wheel as stated above in steps #1, #2, #3, and #4, with the exception that bushing "A" in finger "B" is pressed down until the catch-up wheel has proper endshake.

Now note the position of slot in collet in relation to the pin "E" on wheel. Hold the catch-up wheel stationary while turning the collet clockwise with a collet mover. Turn the collet one complete revolution until it is back to its original position.

D. HAZARDS IN ASSEMBLY OF CATCH-UP ASSEMBLY:

The fourth wheel post should be examined for burrs before replacing the catch-up wheel. The jewels in catch-up wheel should be carefully cleaned, pegged out, and examined for imperfections before replacing catch-up hairspring on wheel.

E. FUNCTION OF CATCH-UP ASSEMBLY:

The function of the catch-up assembly is to do two things:

1. It transfers power from the train of the watch to the chronograph mechanism.
2. When the chronograph is engaged, it permits the seconds wheel to be held stationary while the watch continues to run. When the seconds wheel is released, the catch-up assembly makes it possible for the chronograph to "catch-up" the time elapsed that the wheels were held stationary and register the correct total time elapsed since the beginning of the registration.

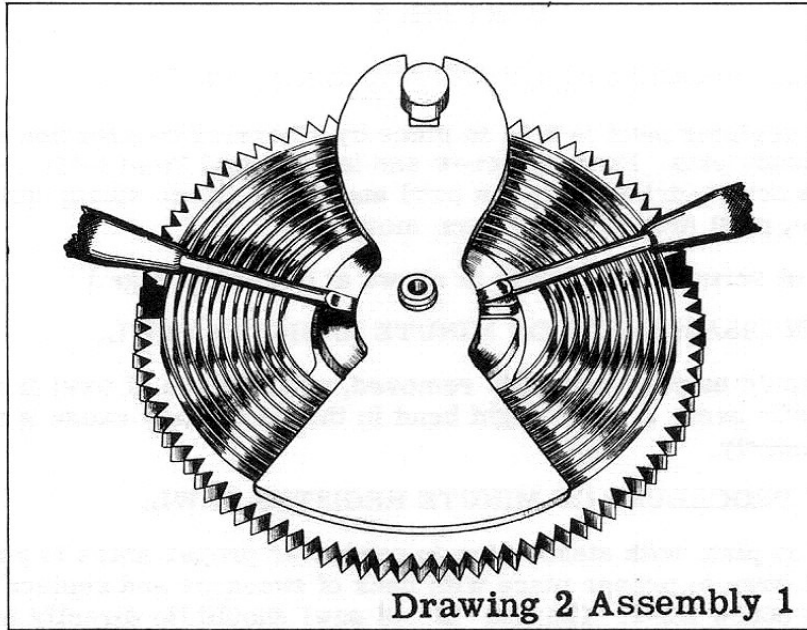

Drawing 2 Assembly 1

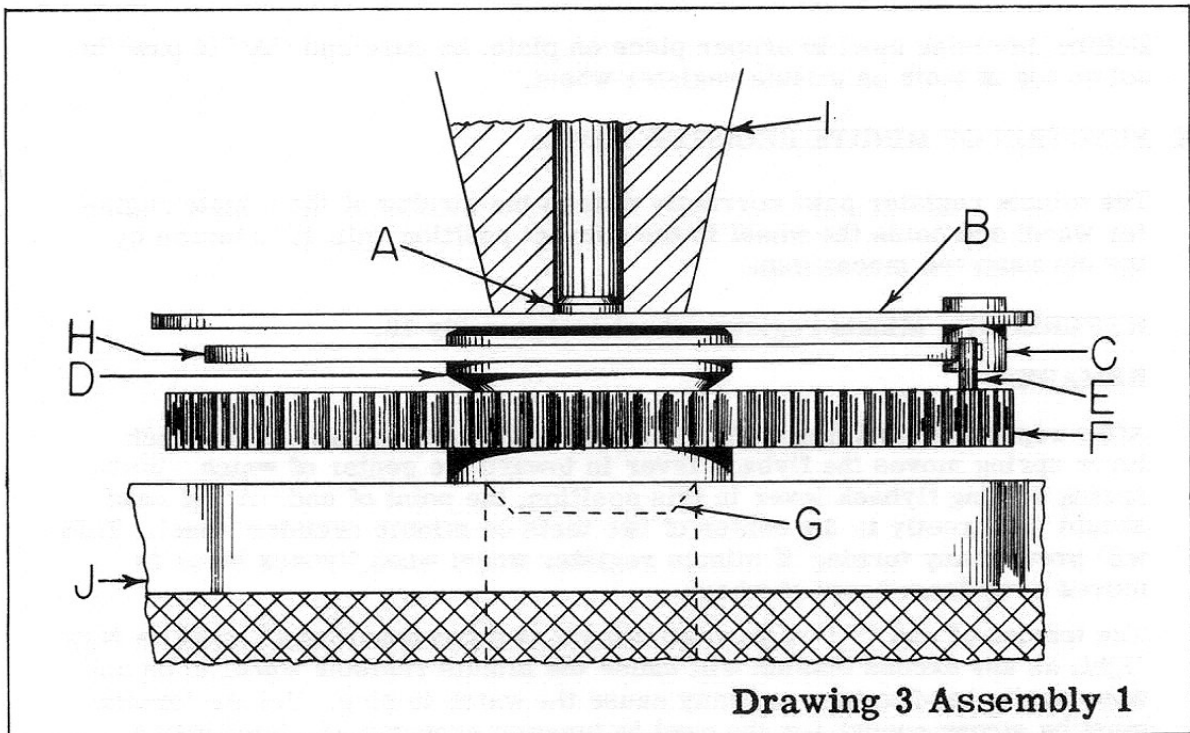

Drawing 3 Assembly 1

- | | |
|--------------------------|--------------------------|
| A. Bushing in Finger | F. Catch-up Wheel |
| B. Finger | G. Hub on Catch-up Wheel |
| C. Hairspring Stud | H. Hairspring |
| D. Hairspring Collet | I. Stake Punch |
| E. Pin on Catch-up Wheel | J. Stake Anvil |

PART NO. 2

A. DISASSEMBLY PROCEDURE OF MINUTE REGISTER PAWL:

The minute register pawl is held in place by a beveled countersink screw BS-1 and steady pins. Remove screw and loosen pawl from plate by sliding a thin blade screw-driver between pawl and plate. When steady pins are free in plate, pawl may be lifted from movement.

(The shape of screw for this part is shown at bottom of page.)

B. HAZARDS IN DISASSEMBLY OF MINUTE REGISTER PAWL:

The pawl should be very carefully removed, as the blade of pawl is very thin and easily bent. A very slight bend in this blade may cause it not to function properly.

C. ASSEMBLY PROCEDURE OF MINUTE REGISTER PAWL:

Place pawl on plate with steady pins in pawl over proper holes in plate. Press pawl down to proper place with back of tweezers and replace beveled countersink screw BS-1. The end "A" of pawl should lie directly in the center of two teeth on the minute register wheel.

D. HAZARDS IN ASSEMBLY OF MINUTE REGISTER PAWL:

Before pressing pawl to proper place on plate, be sure end "A" of pawl is not on top of tooth on minute register wheel.

E. FUNCTION OF MINUTE REGISTER PAWL:

The minute register pawl correctly spaces the turning of the minute register wheel and holds the wheel in the correct position until it is turned by the chronograph mechanism.

REFERENCE: Minute register wheel is Assembly 18.

REMARKS:

After replacing pawl, the castle wheel should be turned until the flyback lever spring moves the flyback lever in toward the center of watch. With spring holding flyback lever in this position, the point of end "A" of pawl should lie directly in the center of two teeth on minute register wheel. This will prevent any turning of minute register wheel when flyback lever is moved away from heart of wheel.

The tension of end "A" of pawl on minute register wheel teeth must be very light, as any excess tension will cause the minute register wheel to be unnecessarily hard to turn and may cause the watch to stop. Yet the tension must be strong enough for the pawl to function properly as stated above.

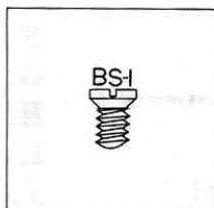

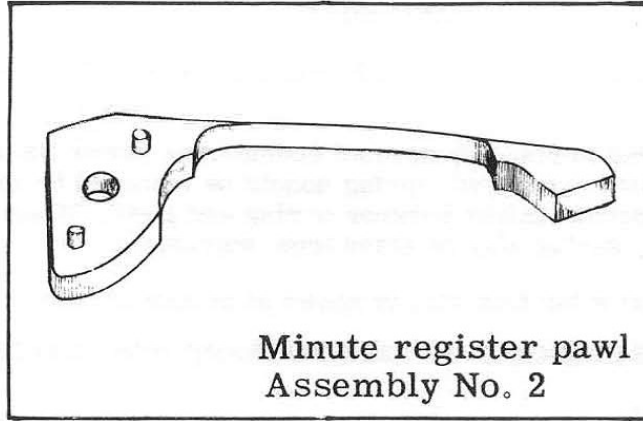

OILING

The minute register pawl should not be oiled.

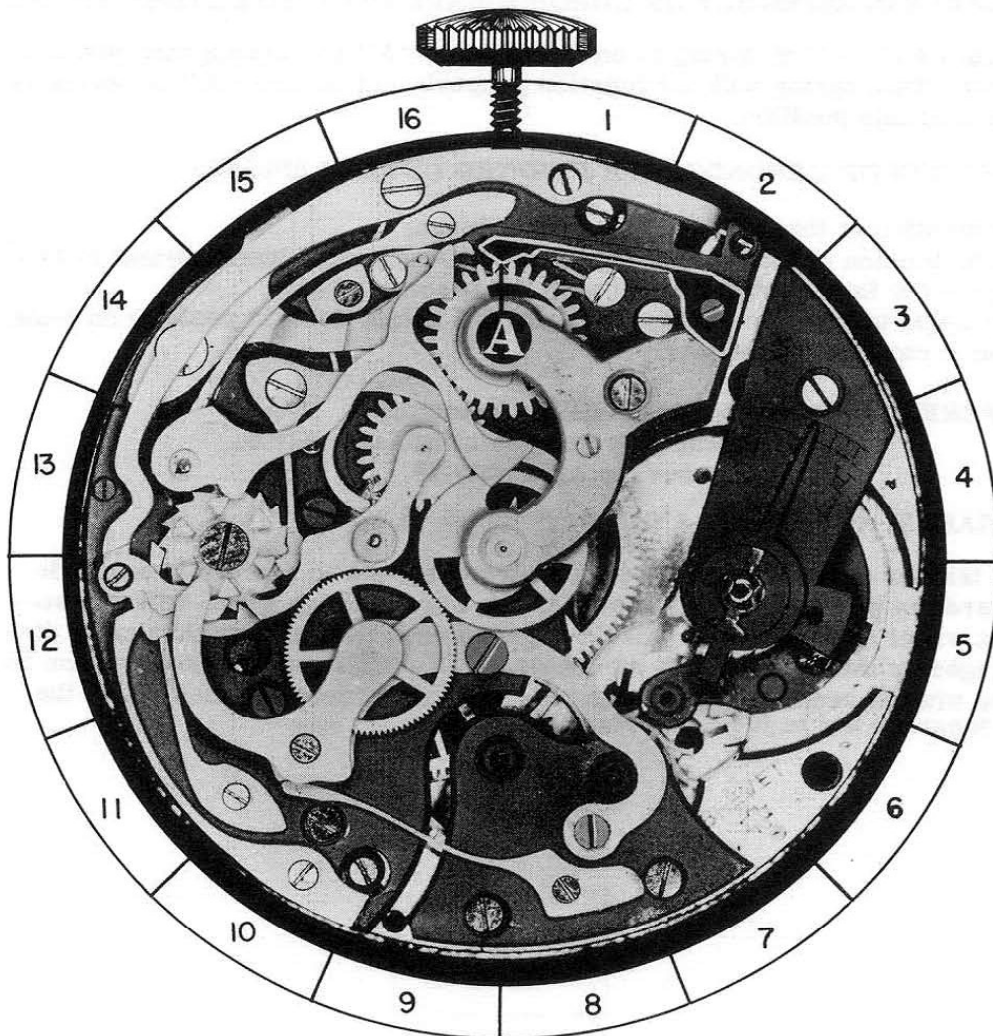

2-A

PART NO. 3

A. DISASSEMBLY PROCEDURE OF CHRONOGRAPH PIVOTED DETENT SPRING:

This spring is held in place by beveled countersink screw BS-2 and steady pins. After screw is removed, spring should be loosened from plate by sliding a thin blade screw-driver between spring and plate. When steady pins are free in plate, spring may be lifted from movement.

(The shape of screw for this part is shown at bottom of page.)

B. HAZARDS IN DISASSEMBLY OF CHRONOGRAPH PIVOTED DETENT SPRING:

Hold finger over spring when removing spring from plate. This will prevent possible loss of screw or spring.

C. ASSEMBLY PROCEDURE OF CHRONOGRAPH PIVOTED DETENT SPRING:

Place spring in proper position on plate with steady pins over proper holes in plate. End "A" of spring should be on top of point "A" on chronograph pivoted detent. Now press spring down to its correct place and replace beveled countersink screw BS-2.

D. HAZARDS IN ASSEMBLY OF CHRONOGRAPH PIVOTED DETENT SPRING:

Be sure end "A" of spring is on top of point "A" on chronograph pivoted detent. This spring will not function properly unless end "A" of spring is placed in this position.

E. FUNCTION OF CHRONOGRAPH PIVOTED DETENT SPRING:

The function of this spring is to do two things:

1. The tension of this spring moves the chronograph pivoted detent to engage the intermediary wheel with the seconds wheel.
2. It helps to hold the chronograph pivoted detent down in position on plate so it can function properly.

REFERENCE: Intermediary wheel is Assembly 5.
Chronograph pivoted detent is Assembly 6.
Seconds wheel is Assembly 19.

REMARKS:

The tension of this spring should be strong enough to move this detent in toward the center of watch to engage the intermediary wheel with the seconds wheel and hold these wheels engaged until they are mechanically disengaged by the chronograph mechanism. Of course, any excess tension beyond what is required for the spring to function correctly may cause the chronograph not to function properly.

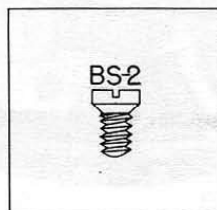

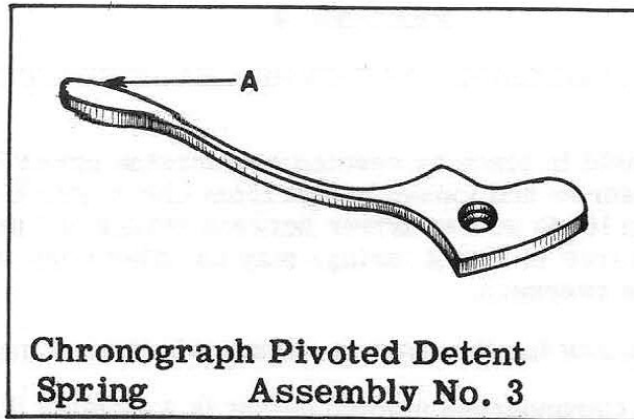

OILING

End "A" of chronograph pivoted detent spring should be slightly moistened with oil.

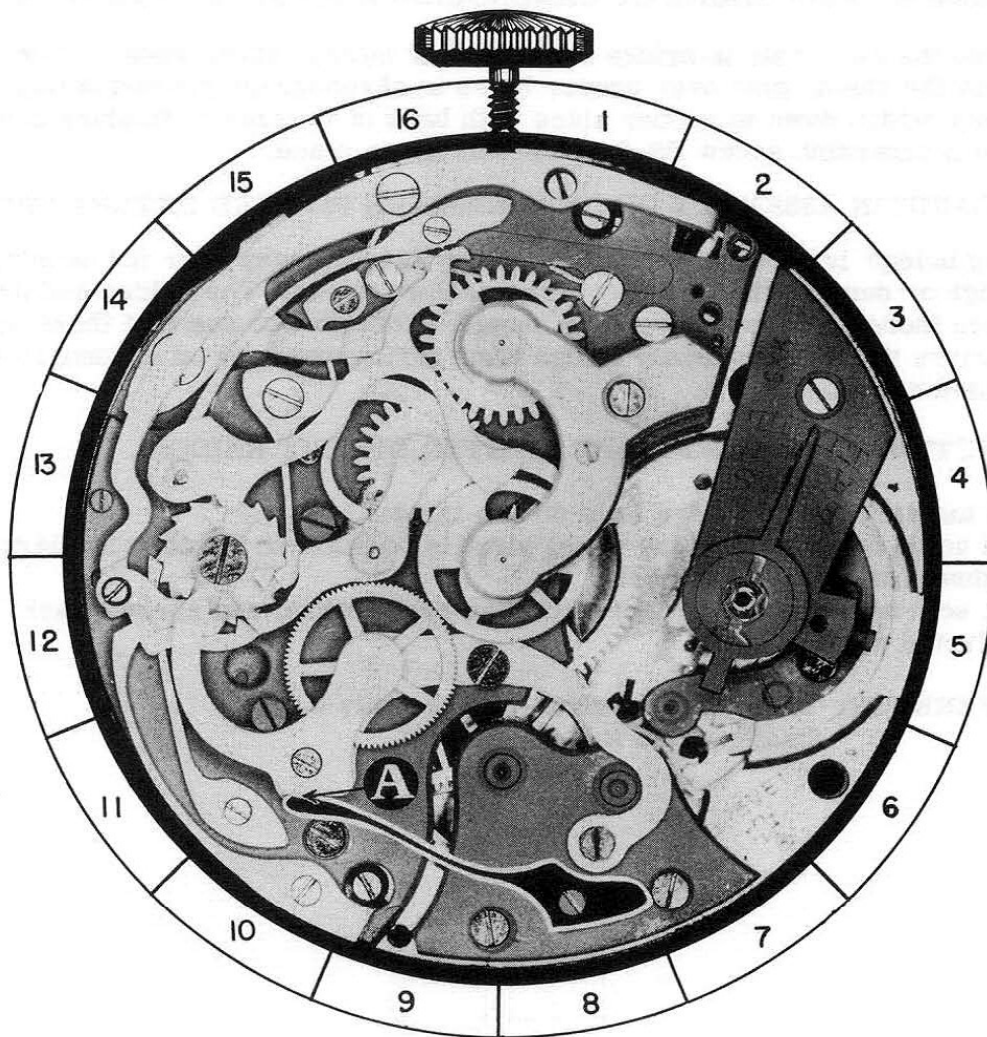

PART NO. 4

A. DISASSEMBLY PROCEDURE OF CHRONOGRAPH PIVOTED DETENT BRIDGE;

This bridge is held in place by beveled countersink screw BS-3 and steady pins. Remove screw and loosen bridge from chronograph pivoted detent by sliding a thin blade screw-driver between bridge and detent. When steady pins are free in detent, bridge may be lifted from intermediary wheel pivot with tweezers.

(The shape of screw for this part is shown at bottom of page.)

REFERENCE: Chronograph pivoted detent is Assembly 6.

B. HAZARDS IN DISASSEMBLY OF CHRONOGRAPH PIVOTED DETENT BRIDGE:

When removing bridge from chronograph pivoted detent, care should be taken to keep bridge level, as any twisting may damage pivots on intermediary wheel or burr the bushings in bridge or chronograph pivoted detent.

C. ASSEMBLY PROCEDURE OF CHRONOGRAPH PIVOTED DETENT BRIDGE.

Place the pivot hole in bridge over pivot of intermediary wheel. Now place the steady pins over proper holes in chronograph pivoted detent and press bridge down to proper place with back of tweezers. Replace beveled countersink screw BS-3 to hold bridge in place.

D. HAZARDS IN ASSEMBLY OF CHRONOGRAPH PIVOTED DETENT BRIDGE:

Keep bridge level when replacing, as any twisting may burr the bushing in bridge or damage the pivots on intermediary wheel. The bridge and detent where these parts come together should be checked to see that there are no burrs that would prevent bridge from fitting properly on chronograph pivoted detent.

E. FUNCTION OF CHRONOGRAPH PIVOTED DETENT BRIDGE:

The function of this bridge is to do two things:

1. It holds the intermediary wheel pivot in position so the intermediary wheel can function properly.
2. It acts as a connecting lever between castle wheel and chronograph pivoted detent.

REFERENCE: Intermediary wheel is Assembly 5.
Castle wheel is Assembly 26.

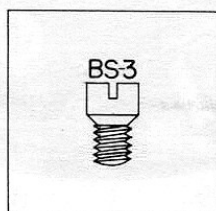

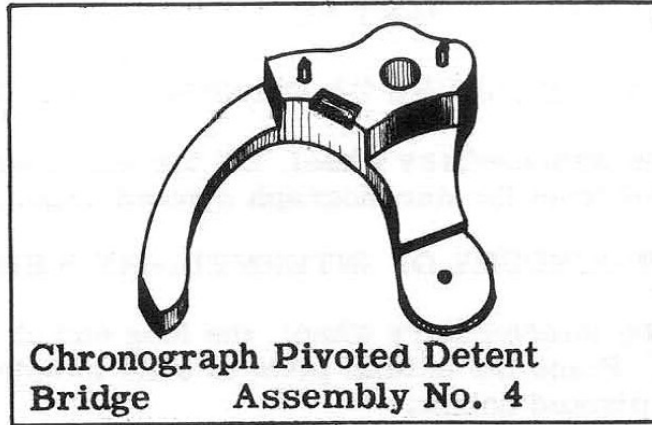

**Chronograph Pivoted Detent
Bridge Assembly No. 4**

OILING

The pivot in chronograph pivoted detent bridge should be oiled as you would properly oil a train pivot in a watch.

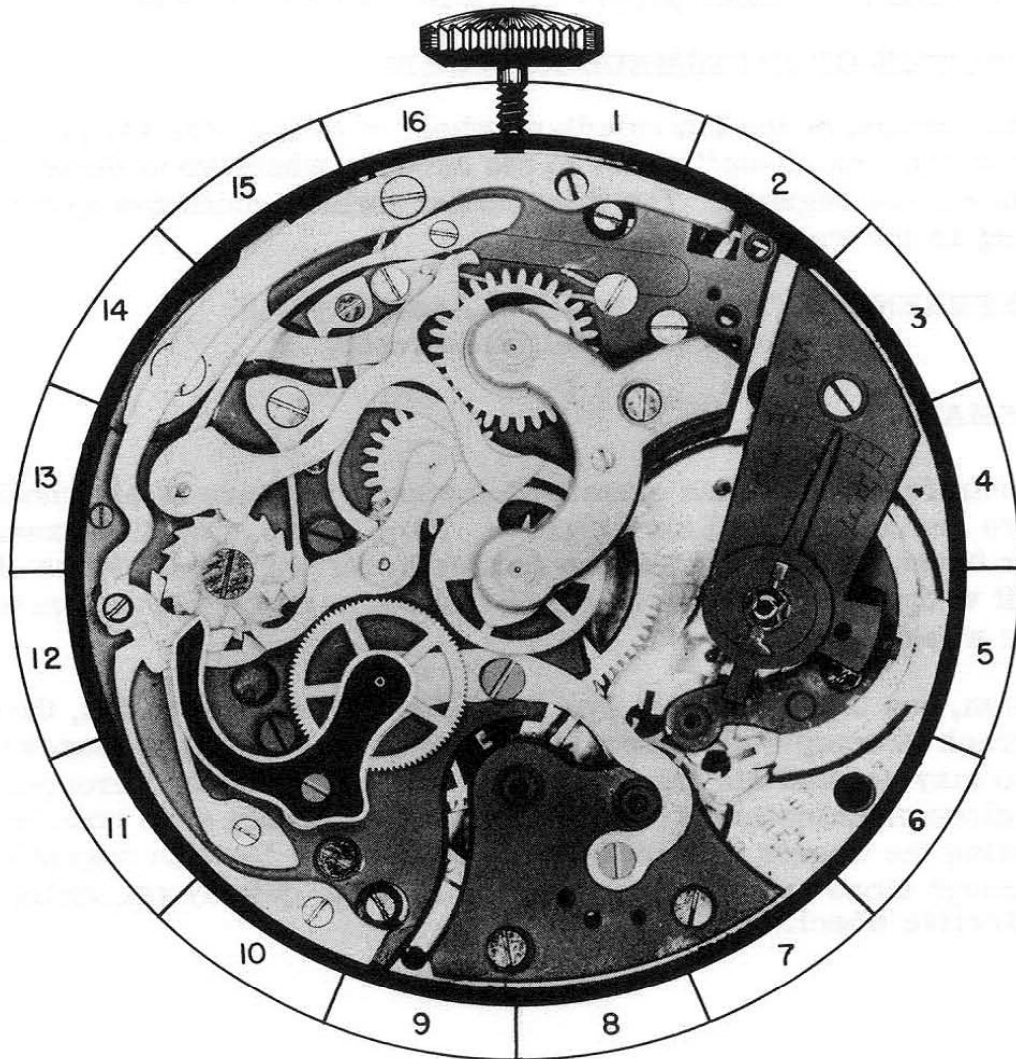

4-A

PART NO. 5

A. DISASSEMBLY PROCEDURE OF INTERMEDIARY WHEEL:

To remove the intermediary wheel, lift the wheel straight up to remove the pivot from the chronograph pivoted detent.

B. ASSEMBLY PROCEDURE OF INTERMEDIARY WHEEL:

When replacing intermediary wheel, the long end of staff "A" should be up. Place the bottom pivot of staff in hole in bushing in chronograph pivoted detent.

REFERENCE: Chronograph pivoted detent is Assembly 6.

C. HAZARDS IN ASSEMBLY OF INTERMEDIARY WHEEL:

Pivot hole in bushing of chronograph pivoted detent should be carefully examined for any imperfections before replacing intermediary wheel. Any imperfections here will affect the timekeeping of watch and will hinder proper operation of chronograph.

D. FUNCTION OF INTERMEDIARY WHEEL:

The function of the intermediary wheel is to transfer the power from the "catch-up" wheel to the seconds wheel when these wheels are engaged. The intermediary wheel continues to turn as long as the watch is running.

REFERENCE: Catch-up wheel is Assembly 1-F.
Seconds wheel is Assembly 19.

REMARKS:

A careful and detailed examination should be made of all wheels before replacing in the chronograph. Each wheel should be examined for burred pivots, bent or burred teeth, dirt or small pieces of grit wedged between the teeth, or any parts which may be loose on the wheel.

Often, due to carelessness or lack of detailed observation, the chronograph is completely assembled before some defect is discovered, and may necessitate the complete disassembly of the chronograph. A close examination of these wheels will not only save time by having the wheels correct before replacing in the chronograph, but through close examination, you will learn to quickly recognize a defective wheel.

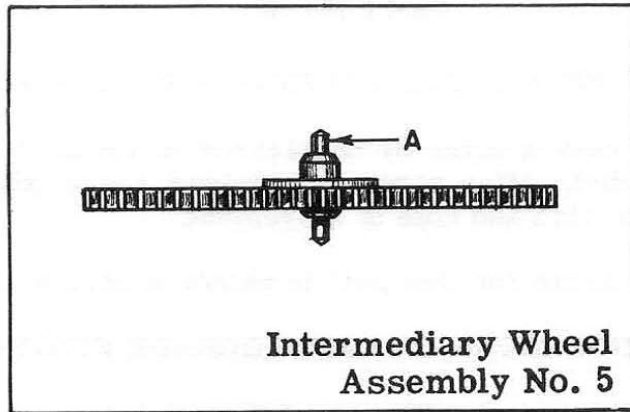

Intermediary Wheel
Assembly No. 5

OILING

The bottom pivot of intermediary wheel should be oiled before replacing pivot in place in chronograph pivoted detent. The top pivot should be oiled after bridge for this wheel is placed in watch.

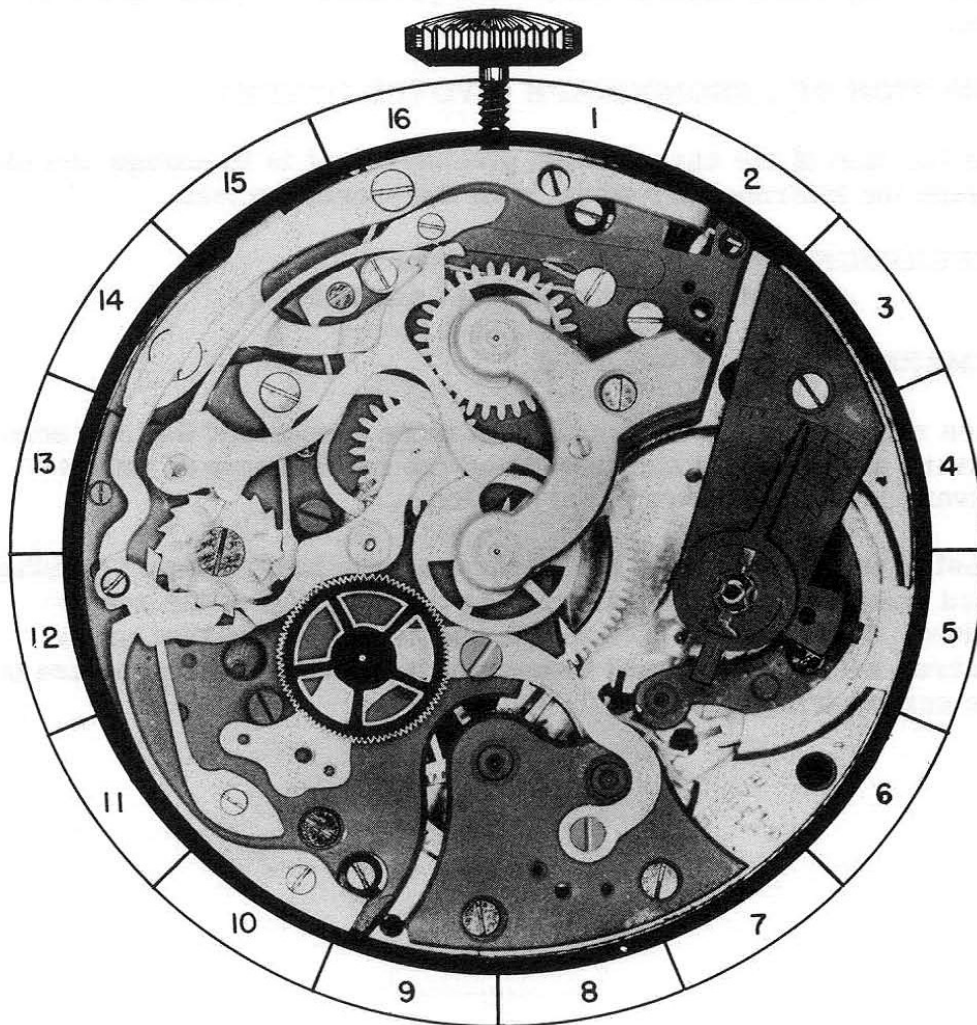

5-A

PART NO. 6

A. DISASSEMBLY PROCEDURE OF CHRONOGRAPH PIVOTED DETENT:

This detent is held in place by shouldered screw SS-1 and pivots on an eccentric stud. After screw is removed, the detent may be lifted from eccentric stud and free of movement.

(The shape of screw for this part is shown at bottom of page.)

B. ASSEMBLY PROCEDURE OF CHRONOGRAPH PIVOTED DETENT:

Place detent in proper position on plate with hole in end of detent over eccentric stud, as detent pivots on the stud. When detent is in proper place, shouldered screw SS-1 may be replaced. Detent must move freely under head of screw.

C. HAZARDS IN ASSEMBLY OF CHRONOGRAPH PIVOTED DETENT:

After replacing detent, check to see that it has enough freedom to work freely under head of screw and yet does not have excess freedom.

D. FUNCTION OF CHRONOGRAPH PIVOTED DETENT:

The function of the chronograph pivoted detent is to engage and disengage the intermediary wheel with the seconds wheel.

REFERENCE: Seconds wheel is Assembly 19.
Intermediary wheel is Assembly 5.

REMARKS:

When repairing a chronograph, it is most important that the screw-drivers are properly sharpened and the correct size of screw-driver blade used for each screw slot.

Most of the screws used in the chronograph have a highly polished head and are very easily marred by a slight slip of the screw-driver. To repair a chronograph and have these screw heads marred will indicate carelessness, either in sharpening or use of the screw-driver.

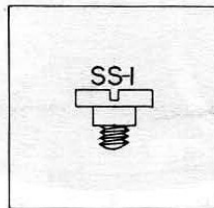

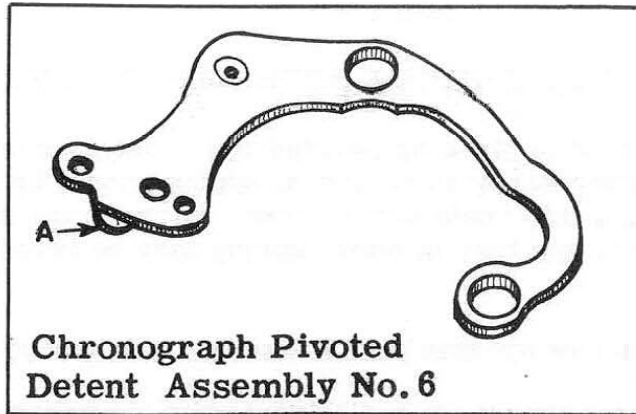

**Chronograph Pivoted
Detent Assembly No. 6**

OILING

The eccentric stud that chronograph pivoted detent pivots on should be slightly moistened with oil.

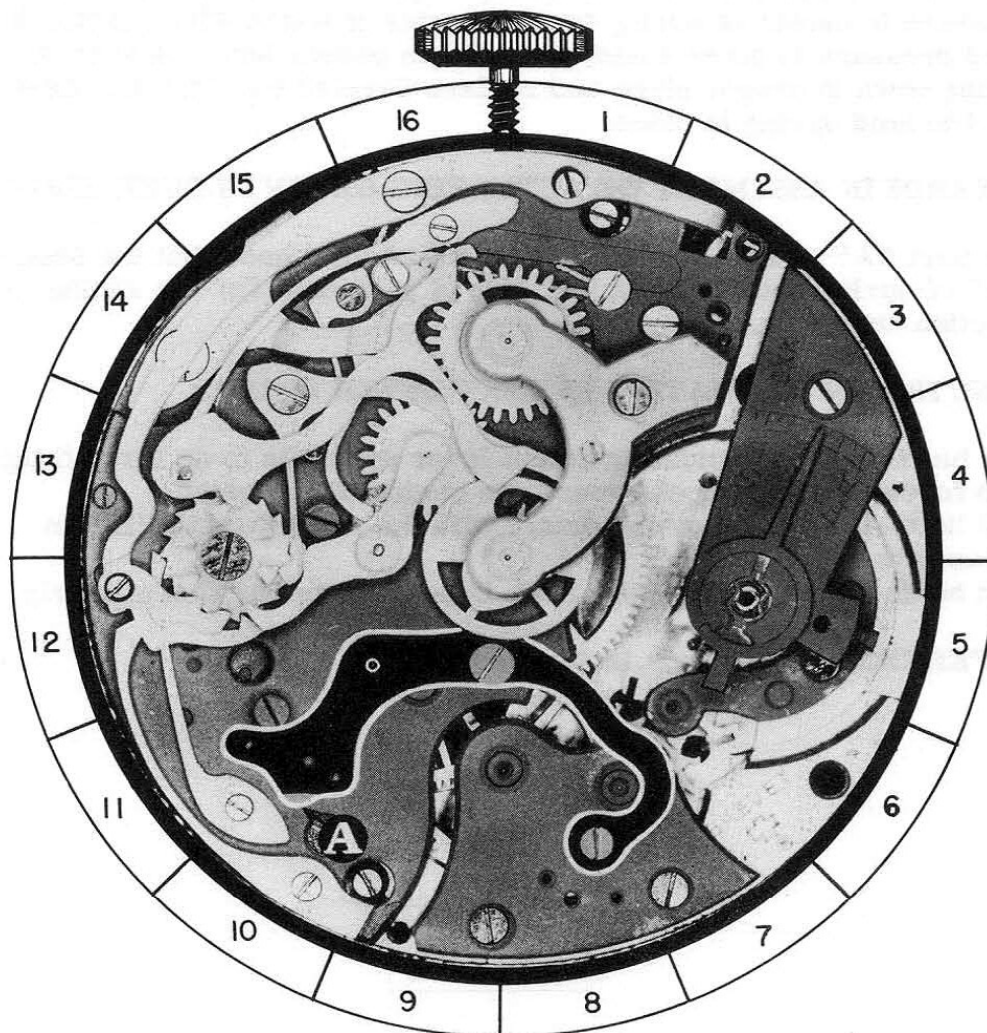

6-A

PART NO. 7

A. DISASSEMBLY PROCEDURE OF ACTUATING DETENT LEVER SPRING:

This spring is held in place by beveled countersink screw BS-4 and steady pins. After screw is removed, spring should be loosened from plate by sliding a thin blade screw-driver between the spring and plate. When steady pins are free in plate, spring may be lifted from movement.

(The shape of screw for this part is shown at bottom of page.)

B. HAZARDS IN DISASSEMBLY OF ACTUATING DETENT LEVER SPRING:

Hold finger on spring while removing screw and loosening spring from plate to prevent loss of spring or screw.

C. ASSEMBLY PROCEDURE OF ACTUATING DETENT LEVER SPRING:

Place spring in position with steady pin "C" started in proper hole in plate. Now place part "A" of spring in place on joint hook. Apply pressure to center of spring toward center of watch with slightly downward pressure to place steady pin "D" in proper hole. Now press spring down in proper place and replace beveled countersink screw BS-4 to hold spring in place.

D. HAZARDS IN ASSEMBLY OF ACTUATING DETENT LEVER SPRING:

The part "A" of spring should be on top of joint hook, but the shoulder "B" of spring should fit against side of joint hook for the spring to function correctly.

E. FUNCTION OF ACTUATING DETENT LEVER SPRING:

The function of the actuating detent lever spring is to do three things:

1. It forces the joint hook toward the center of the watch.
2. It holds the joint hook in contact with the ratchet teeth "B" on castle wheel.
3. It holds the reversing joint hook in position to function properly.

REFERENCE: Joint hook is Assembly 9.
Reversing joint hook is Assembly 8.

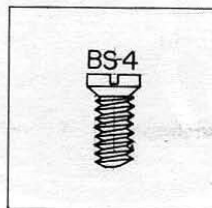

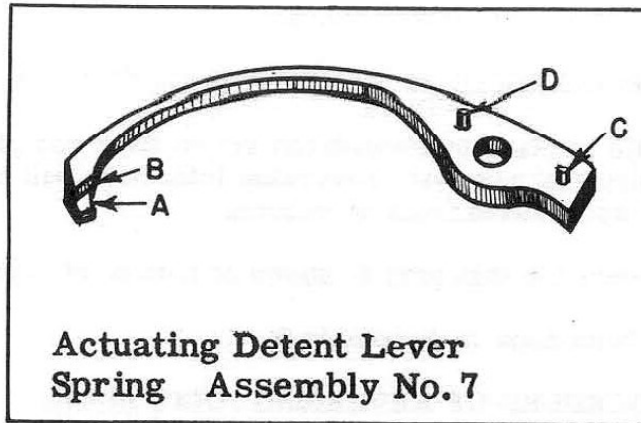

OILING

End "A" of actuating detent lever spring should be slightly moistened with oil at the point it contacts joint hook.

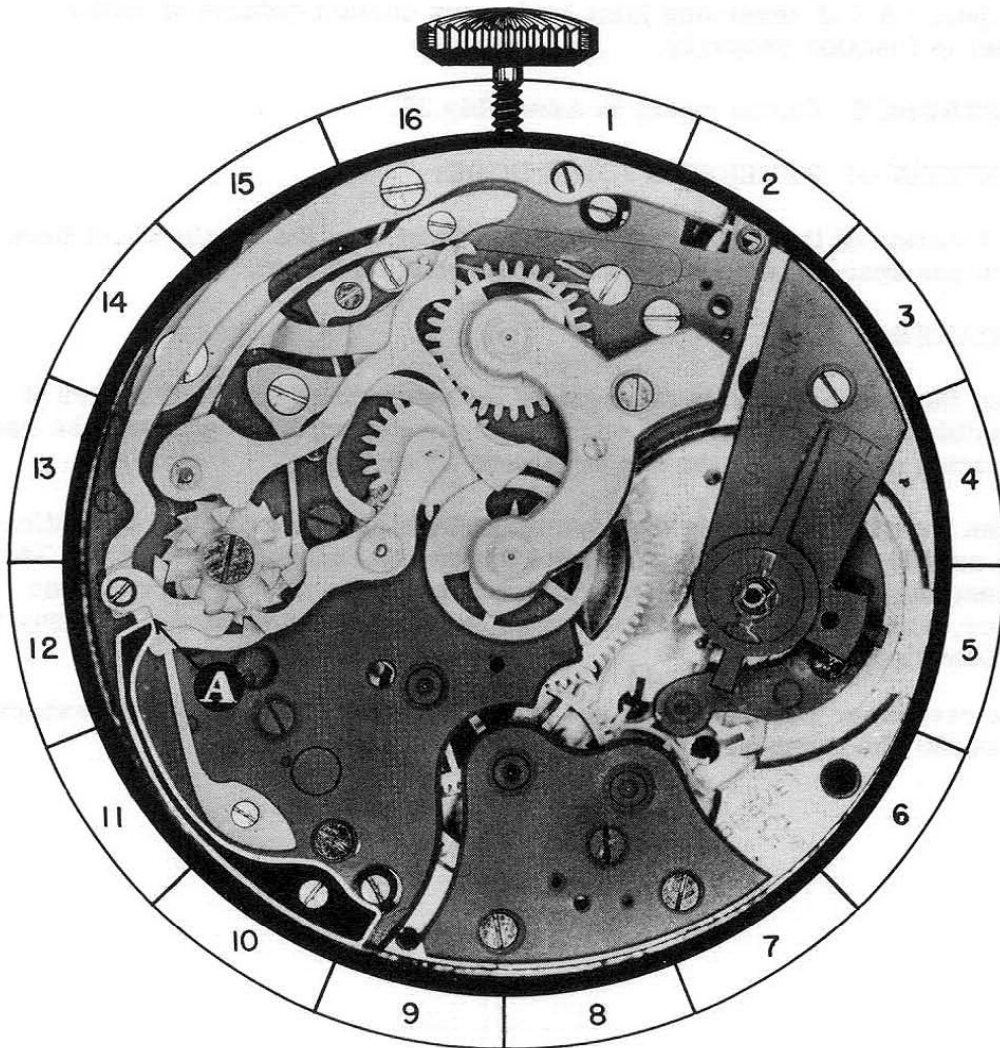

7-A

PART NO. 8

A. DISASSEMBLY PROCEDURE OF REVERSING JOINT HOOK:

This lever is held in place by shouldered screw SS-2 and pivots on this screw. After screw is removed, reversing joint hook will be free on the joint hook and may be lifted from movement.

(The shape of screw for this part is shown at bottom of page.)

REFERENCE: Joint hook is Assembly 9.

B. ASSEMBLY PROCEDURE OF REVERSING JOINT HOOK:

Place the reversing joint hook in place on joint hook with part "A" of hook in contact with column of castle wheel. Now replace shouldered screw SS-2 to hold the reversing joint hook and joint hook in place. These two parts should turn freely under head of shouldered screw and the hooks should not bind each other.

C. HAZARDS IN ASSEMBLY OF REVERSING JOINT HOOK:

The part "A" of reversing joint hook must contact column of castle wheel to function properly.

REFERENCE: Castle wheel is Assembly 26.

D. FUNCTION OF REVERSING JOINT HOOK:

The function of the reversing joint hook is to turn the castle wheel backward one space to engage the chronograph mechanism.

REMARKS:

When the chronograph is disengaged the reversing joint hook makes it possible for the operator to engage the chronograph to continue the registration or to return the hands to zero at will.

When the chronograph is disengaged and the operator wishes to continue the registration, the operator pulls out on the chronograph button. This causes the reversing joint hook to turn the castle wheel backward one space, which permits the chronograph to become engaged and continue the registration.

The reversing joint hook will not turn the castle wheel backward except when the chronograph mechanism is disengaged.

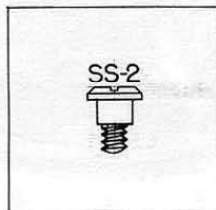

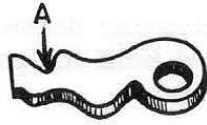

**Reversing Joint Hook
Assembly No. 8**

OILING

The shoulder of screw that joint hook and reversing joint hook pivots on should be slightly moistened with oil.

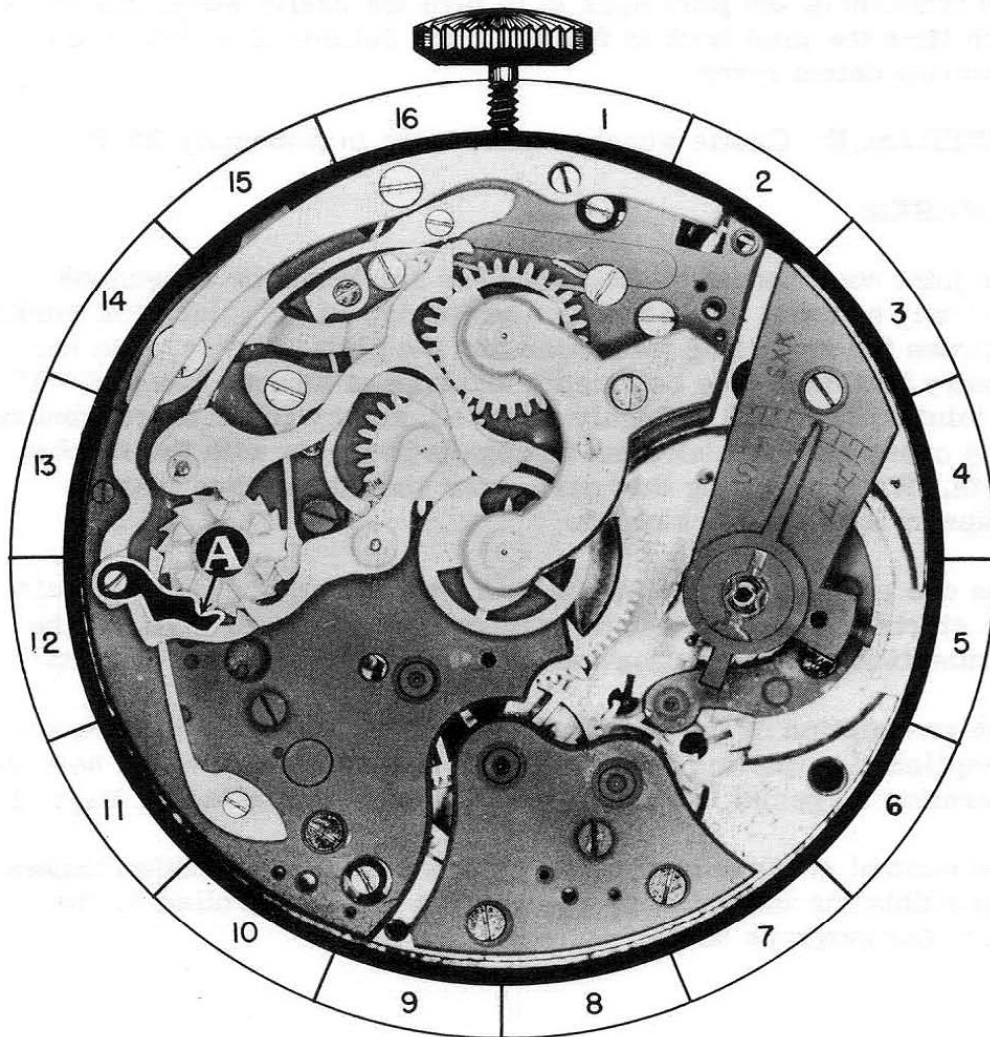

8-A

PART NO. 9

A. DISASSEMBLY PROCEDURE OF JOINT HOOK:

The joint hook is free on actuating detent lever, as it was held in place by the same screw that held the previous part in place. Simply lift joint hook out of place.

REFERENCE: Actuating detent lever is Assembly 10.

B. ASSEMBLY PROCEDURE OF JOINT HOOK:

The joint hook is placed in position with the hole in joint hook over hole in end "A" of actuating detent lever and end "A" of joint hook in contact with the ratchet teeth on castle wheel. The screw to hold this part in place is not replaced until the next part is assembled.

C. FUNCTION OF JOINT HOOK:

The function of the joint hook is to turn the castle wheel one space each time the joint hook is forced to the outside of watch by the actuating detent lever.

REFERENCE: Castle wheel ratchet teeth is Assembly 26-B.

REMARKS:

The joint hook should be examined for any burrs or roughness that may cause it not to function properly, as the joint hook works between the reversing joint hook and the plate. Hence, it is necessary that each side be smooth and free of burrs. The end "A" of joint hook should be highly polished, as any burrs or roughness may cause the joint hook not to engage properly with the ratchet teeth. When polishing this part, care should be taken that the shape of hook is not changed.

The one chronograph button on this type of chronograph controls the starting, the stopping, the returning of hands to zero, or the resumption of registration without returning the hands to zero.

The resumption of travel without returning the hands to zero accomplished by pulling out on the chronograph button which sets in operation a special feature of this watch, is explained on Page 8.

The control of these operations by one chronograph button makes it possible for the catch-up mechanism to be controlled by the other chronograph button.

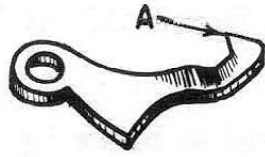

Joint Hook Assembly No. 9

This part is oiled when the next part is put in place.

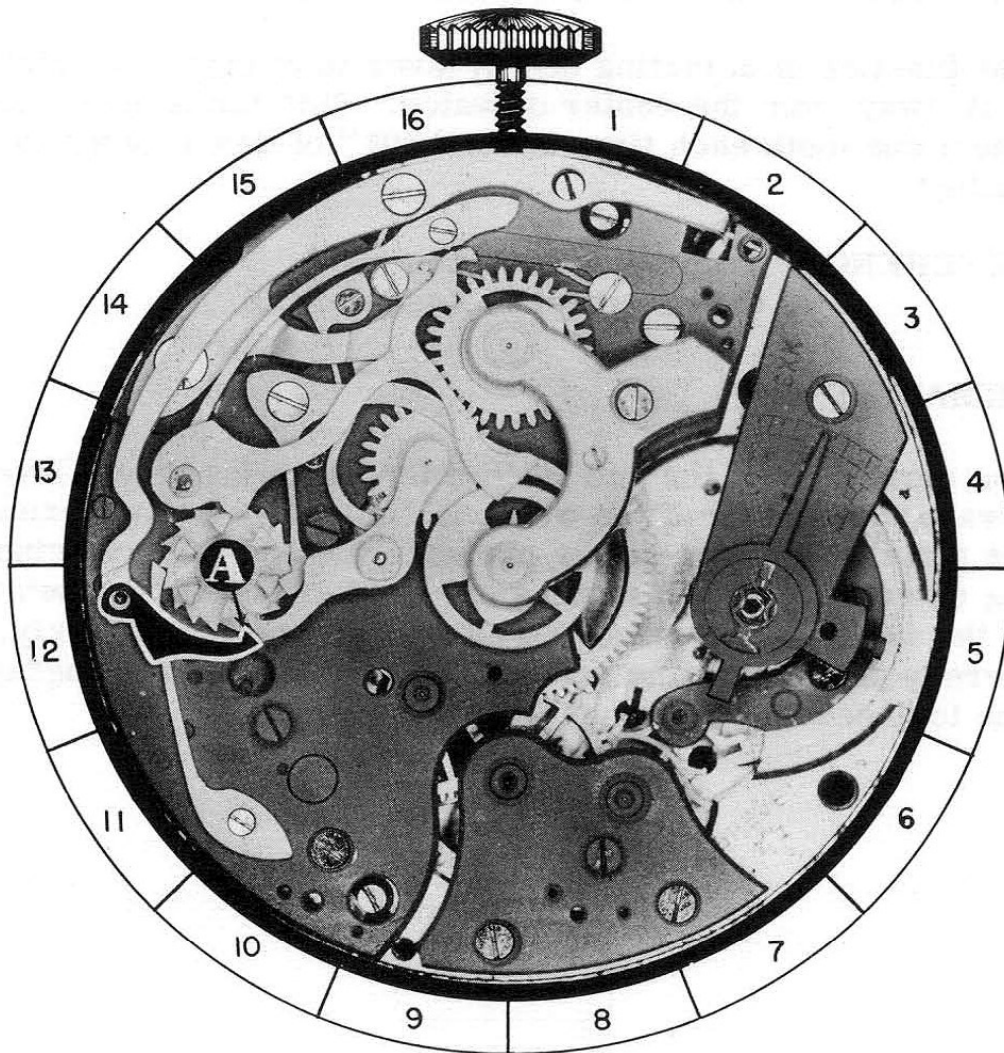

9-A

PART NO. 10

A. DISASSEMBLY PROCEDURE OF ACTUATING DETENT LEVER:

This detent lever is held in place by shouldered screw SS-3 and pivots on this screw. After screw is removed, detent lever may be lifted from movement.

(The shape of screw for this part is shown at bottom of page.)

B. ASSEMBLY PROCEDURE OF ACTUATING DETENT LEVER:

Place the detent lever in the position on plate shown in photograph and replace shouldered screw SS-3. The detent lever should pivot freely under head of screw.

C. FUNCTION OF ACTUATING DETENT LEVER:

The function of actuating detent lever is to move the joint hook away from the center of watch. This turns the castle wheel one tooth each time the end "B" of detent lever is pushed.

REFERENCE: Joint hook is Assembly 9.
Castle wheel is Assembly 26.

REMARKS:

The movement of the end "A" of the actuating detent lever toward the outside of the watch is limited by a stop screw in the plate. This stop screw prevents the end "A" of actuating detent lever from moving any further toward the outside of the watch than is necessary for it to function properly, thereby preventing any possible damage to the chronograph due to excessive movement of this lever.

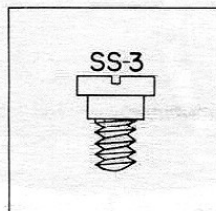

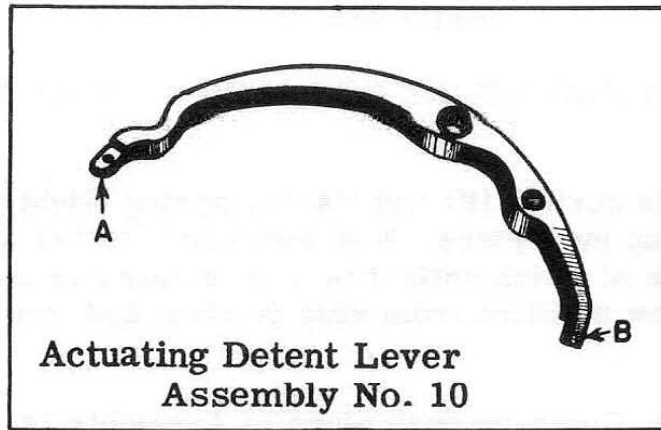

OILING

The shoulder of screw that actuating detent lever pivots on should be slightly moistened with oil.

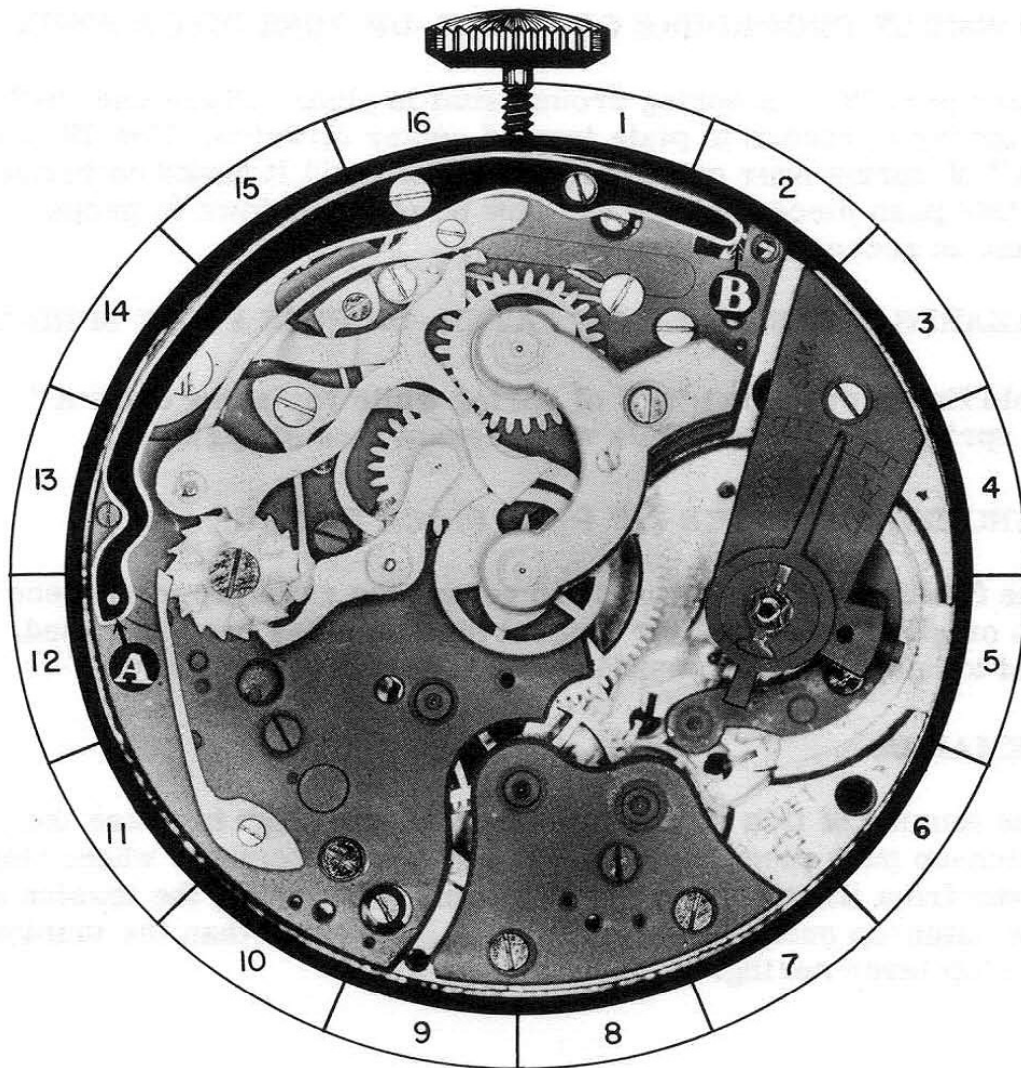

10-A

PART NO. 11

A. DISASSEMBLY PROCEDURE OF CATCH-UP PUSH PIECE SPRING:

To remove this spring, lift end "A" of spring slightly until it clears catch-up push piece. Now move end "A" of spring toward outside of watch until it is free of catch-up push piece. Spring may now be lifted from stud on plate and free of movement.

REFERENCE: Catch-up push piece is Assembly 14.

B. HAZARDS IN DISASSEMBLY OF CATCH-UP PUSH PIECE SPRING:

Hold finger over part "C" of spring while removing end "A" of spring from catch-up push piece. This will prevent loss of spring.

C. ASSEMBLY PROCEDURE OF CATCH-UP PUSH PIECE SPRING:

Place part "C" of spring around stud in plate. Place end "B" of spring in recess in plate toward center of watch. Now lift end "A" of spring over catch-up push piece until it hooks on inside of this push piece. Spring can now be pressed down to proper place in recess.

D. HAZARDS IN ASSEMBLY OF CATCH -UP PUSH PIECE SPRING:

Hold finger over part "C" of spring while replacing end "A" of spring in position. This will prevent loss of spring.

E. FUNCTION OF CATCH-UP PUSH PIECE SPRING:

The function of this spring is to return the catch-up push piece to its original position after manual pressure has been released, and to hold it in this position until it is moved manually.

REMARKS:

The tension of this spring must be strong enough to cause the catch-up push piece to disengage the minute register wheel stop lever from the minute register wheel. Naturally, the tension of the catch-up push piece spring must be greater than the tension of stop lever spring.

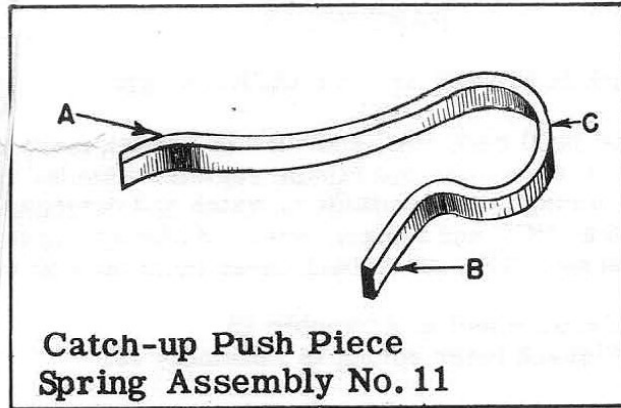

OILING

End "A" of catch-up push piece spring should be slightly moistened with oil at the point it contacts catch-up push piece.

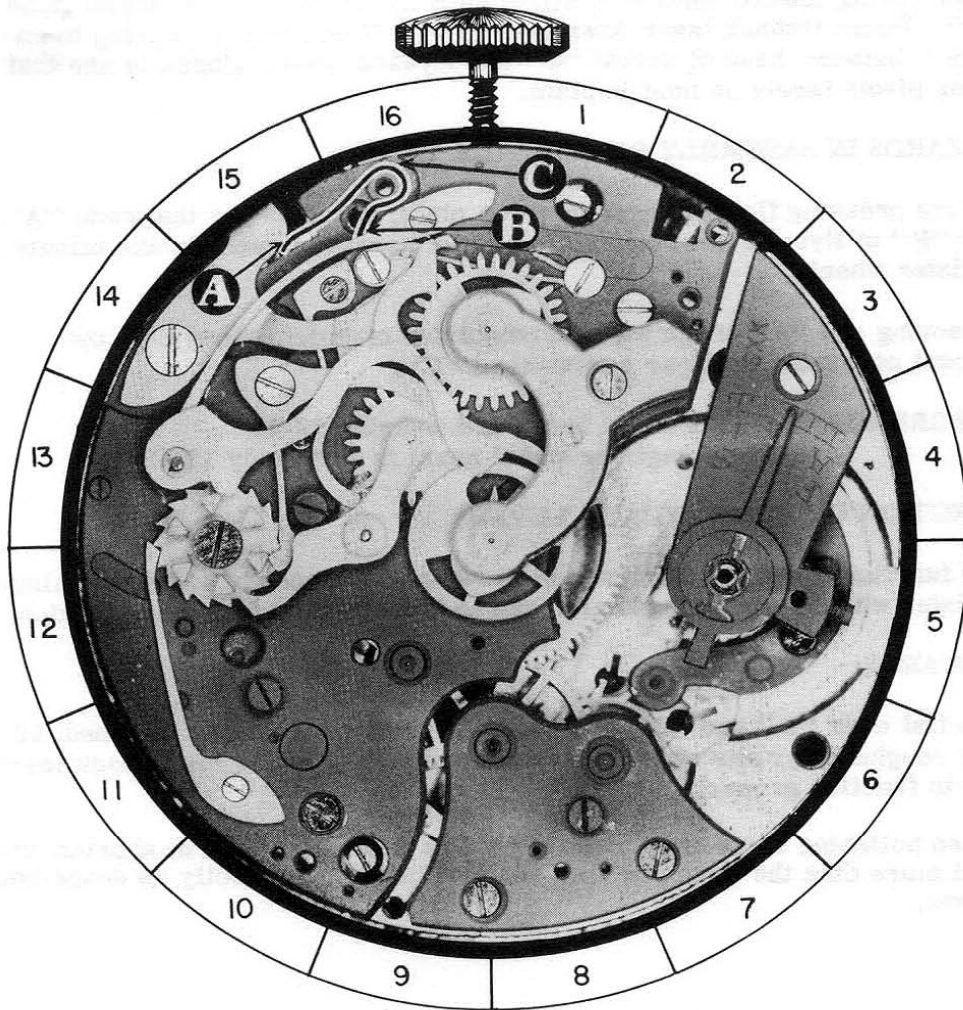

11-A

PART NO. 12

A. DISASSEMBLY PROCEDURE OF FLYBACK LEVER:

Turn castle wheel until ends "A" and "B" of flyback lever are disengaged from hearts of seconds and minute register wheels. Move end "A" of flyback lever spring toward outside of watch and disengage spring from between screw-head "C" and flyback lever. While spring is resting against head of screw "C", lift flyback lever from post on plate.

REFERENCE: Castle wheel is Assembly 26.
Flyback lever spring is Assembly 13.

B. HAZARDS IN DISASSEMBLY OF FLYBACK LEVER:

In moving end "A" of spring toward outside of watch, move only the amount necessary to clear screw-head "C".

C. ASSEMBLY PROCEDURE OF FLYBACK LEVER:

Place flyback lever on post in plate with screw-head "C" on lever down. Hold flyback lever in place with finger. Now move end "A" of flyback lever spring toward outside of watch until spring is clear of screw-head "C". Press flyback lever down on post with finger and lift spring to engage it between head of screw "C" and flyback lever. Check to see that lever pivots freely on post in plate.

D. HAZARDS IN ASSEMBLY OF FLYBACK LEVER:

Before pressing flyback lever down on plate, check to see that ends "A" and "B" of flyback lever are not on top of hearts of seconds and minute register wheels.

In moving end "A" of spring toward outside of watch, move only the amount necessary to clear screw-head "C".

REFERENCE: Seconds wheel heart is Assembly 19-B.
Minute register wheel heart is Assembly 18-B.

E. FUNCTION OF THE FLYBACK LEVER:

The function of the flyback lever is to return the seconds wheel and minute register wheel and the hands attached to these wheels to a zero position.

REMARKS:

The flat ends "A" and "B" of flyback lever must be highly polished, as any roughness or pits of rust at this location may cause the flyback lever not to function properly.

When polishing these ends, care should be taken so as not to shorten one end more than the other, or they will not function correctly as described above.

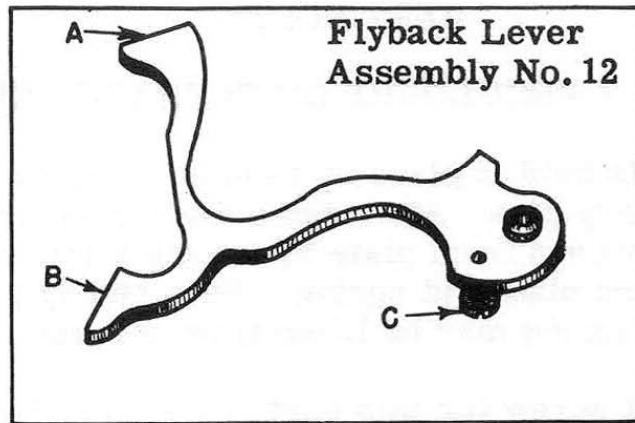

OILING

The post that flyback lever pivots on should be slightly moistened with oil.

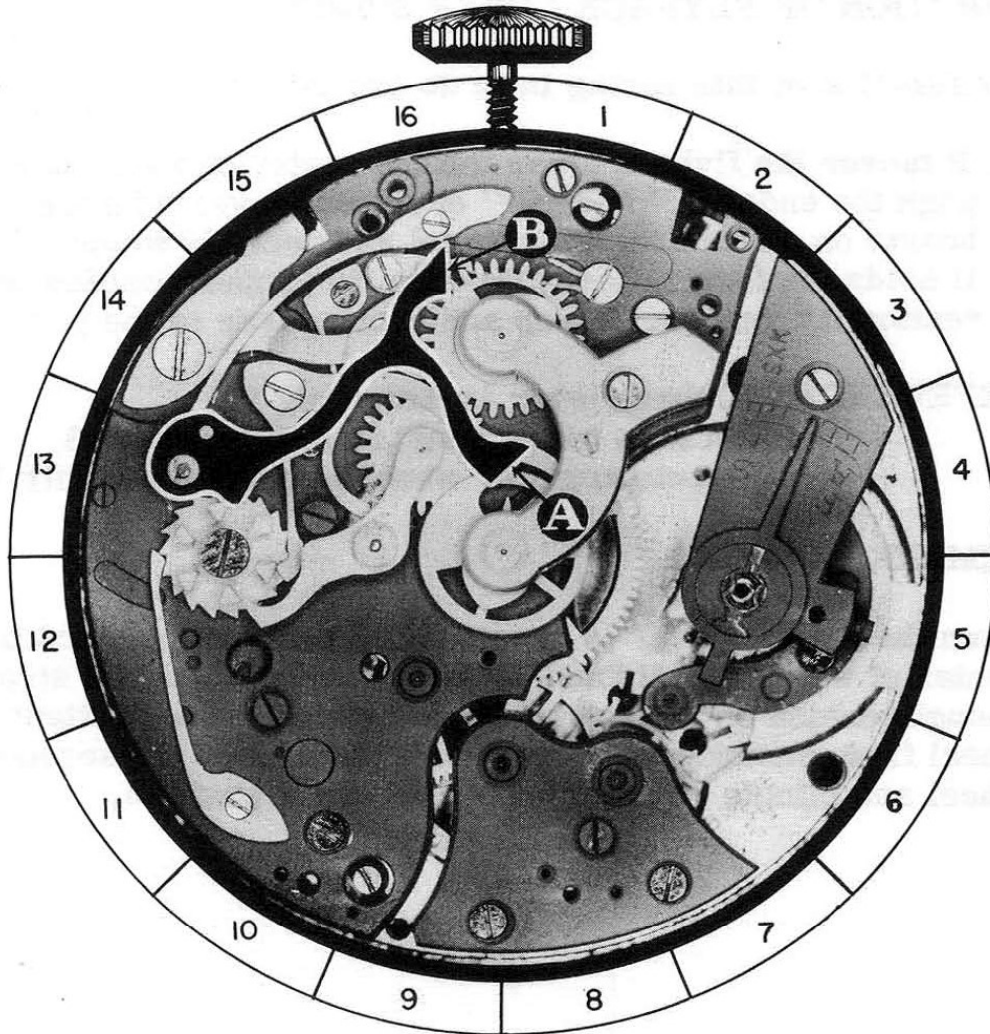

PART NO. 13

A. DISASSEMBLY PROCEDURE OF FLYBACK LEVER SPRING:

This spring is held in place by beveled countersink screw BS-5 and steady pins. After removing screw, the spring should be loosened from plate by sliding a thin blade screwdriver between plate and spring. When steady pins are free in plate, the spring may be lifted from movement.

(The shape of screw for this part is shown at bottom of page.)

B. ASSEMBLY PROCEDURE OF FLYBACK LEVER SPRING:

Place steady pins over proper holes in plate. Now press spring down to correct position on plate and replace beveled countersink screw BS-5 to hold spring in position.

C. FUNCTION OF FLYBACK LEVER SPRING:

The function of this spring is to do two things:

1. It moves the flyback lever toward center of watch to engage the ends "A" and "B" of flyback lever with the hearts on minute register wheel and seconds wheel.
2. It holds the flyback lever down in its proper position preventing it from working up and coming free of the post.

REFERENCE: Flyback lever is Assembly 12.
Seconds wheel heart is Assembly 19-B.
Minute register wheel heart is Assembly 18-B.

REMARKS:

When the flyback lever is permitted to be forced toward the center of watch, the flyback lever spring must hold a strong enough tension on flyback lever to disengage intermittent wheel from seconds wheel dart tooth and force the seconds wheel and minute register wheel to a zero position.

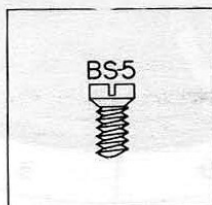

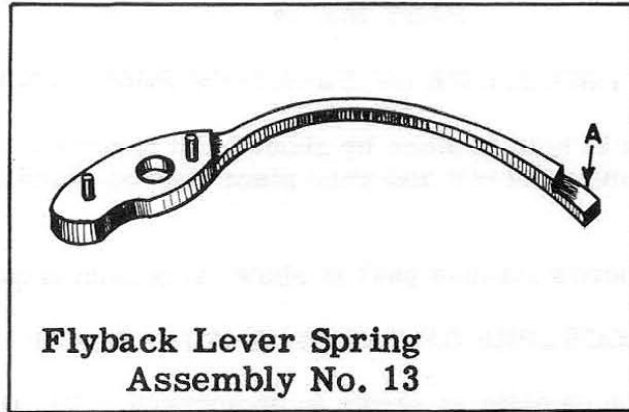

OILING

End "A" of flyback lever spring should be slightly moistened with oil at the point it contacts screw "C" on flyback lever.

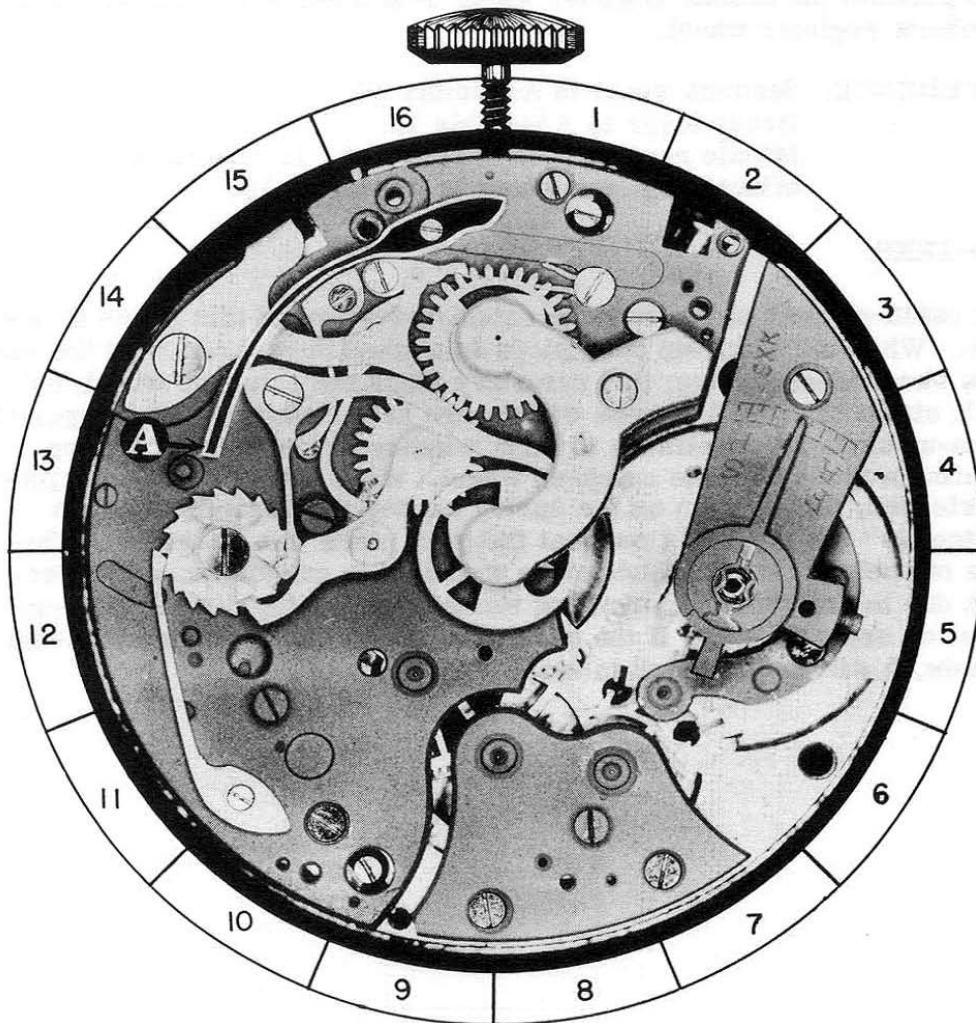

13-A

PART NO. 14

A. DISASSEMBLY PROCEDURE OF CATCH-UP PUSH PIECE:

This push piece is held in place by shouldered screw SS-4 and pivots on this screw. Remove screw and push piece may be lifted from movement.

(The shape of screw for this part is shown at bottom of page.)

B. ASSEMBLY PROCEDURE OF CATCH-UP PUSH PIECE:

Place push piece on plate as shown in photograph. Now replace shouldered screw SS-4 to hold push piece in place. The push piece should turn freely under head of screw.

C. FUNCTION OF CATCH-UP PUSH PIECE:

The function of this push piece is to do two things:

1. It engages brake lever with seconds wheel.
2. It permits the minute register wheel stop lever to engage with the minute register wheel.

REFERENCE: Seconds wheel is Assembly 19.
Brake lever is Assembly 15.
Minute register wheel stop lever is Assembly 21.
Minute register wheel is Assembly 18.

REMARKS:

The catch-up push piece sets the catch-up feature of this watch in operation. When the catch-up push piece is pushed the action stops the seconds wheel from turning; this naturally stops the catch-up wheel, holding it stationary. While these wheels are held stationary, the finger on catch-up assembly continues to turn, winding up the hairspring and creating a tension on the catch-up wheel. When the catch-up push piece is released, this tension on the spring causes the seconds wheel to "catch-up" the lapse of time that the push piece was pushed in. This time out period that the push piece was held in cannot exceed 57 seconds due to the stud on hairspring turning and hitting pin on catch-up wheel on opposite side. If the push piece is held in for more than one minute, it will cause watch to stop.

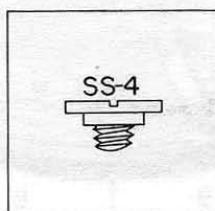

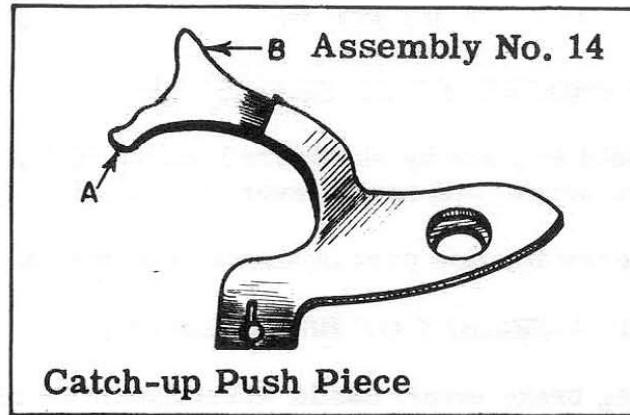

The following parts of catch-up push piece should be slightly moistened with oil:

- A. The shoulder screw that push piece pivots on.
- B. Point "A" on push piece that contacts pin "C" of minute register wheel stop lever.
- C. Point "B" on push piece that contacts brake lever.

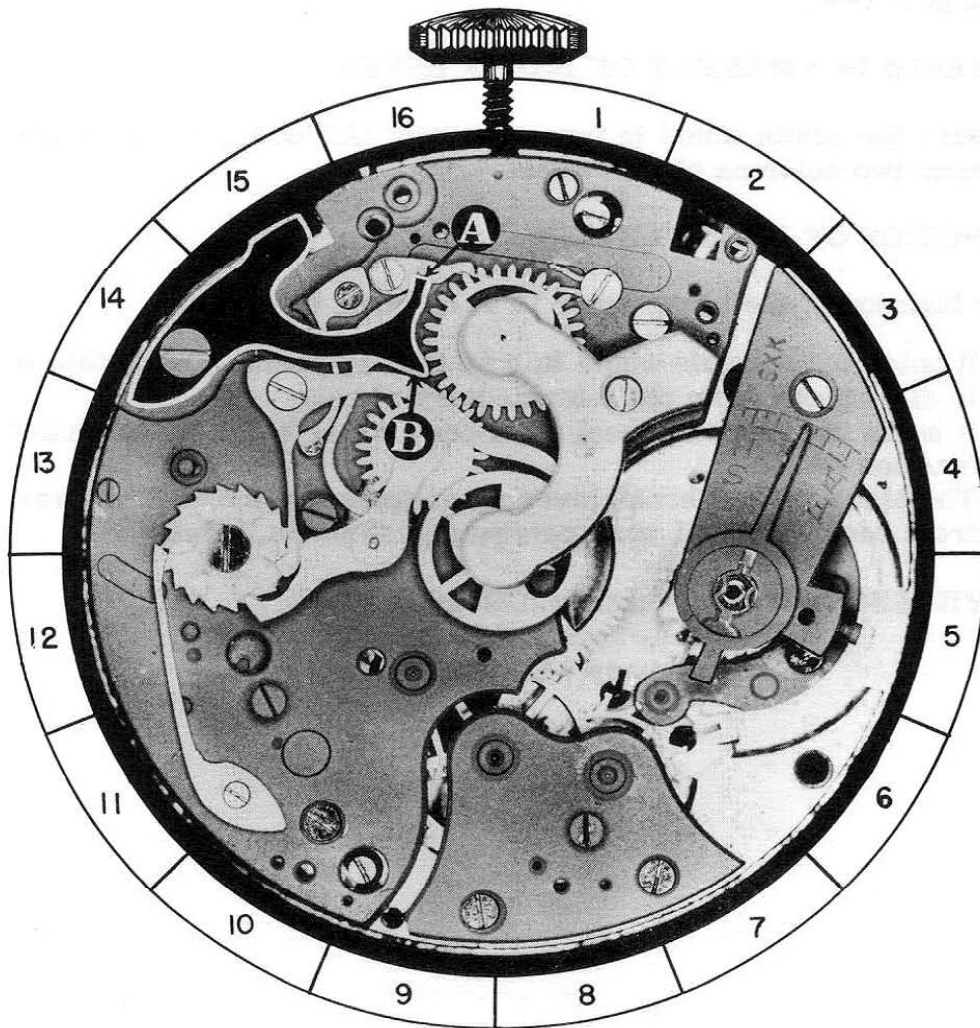

14-A

PART NO. 15

A. DISASSEMBLY PROCEDURE OF BRAKE LEVER:

This lever is held in place by shouldered screw SS-5 and pivots on this screw. Remove screw, and brake lever may be lifted from movement.

(The shape of screw for this part is shown at bottom of page.)

B. HAZARDS IN DISASSEMBLY OF BRAKE LEVER:

Before removing brake lever, castle wheel should be turned so part "A" of brake lever is between two of the columns on castle wheel.

C. ASSEMBLY PROCEDURE OF BRAKE LEVER:

Place brake lever on plate and slide brake lever to its proper position as shown in photograph. The end "A" of lever should be between two columns of castle wheel. Hold brake lever in position with finger and replace shouldered screw SS-5. Brake lever should pivot freely under head of screw.

D. HAZARDS IN ASSEMBLY OF BRAKE LEVER:

Be sure the castle wheel is turned so end "A" of lever can be placed between two columns of this wheel.

E. FUNCTION OF BRAKE LEVER:

The function of the brake lever is to do three things:

1. It holds the seconds wheel in a stationary position when this wheel is disengaged from the intermediary wheel.
2. It holds the seconds wheel stationary so the catch-up mechanism can function properly.
3. The blade "C" of brake lever disengages the end "B" of brake lever from seconds wheel when catch-up push piece is released.

REFERENCE: Castle wheel is Assembly 26.
Seconds wheel is Assembly 19.
Intermediary wheel is Assembly 5.

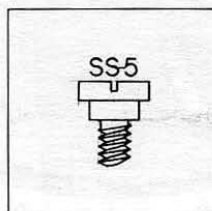

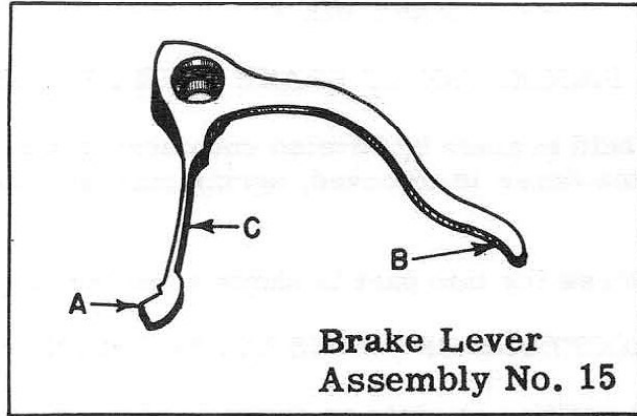

**Brake Lever
Assembly No. 15**

OILING

The shoulder of screw that brake lever pivots on should be slightly moistened with oil.

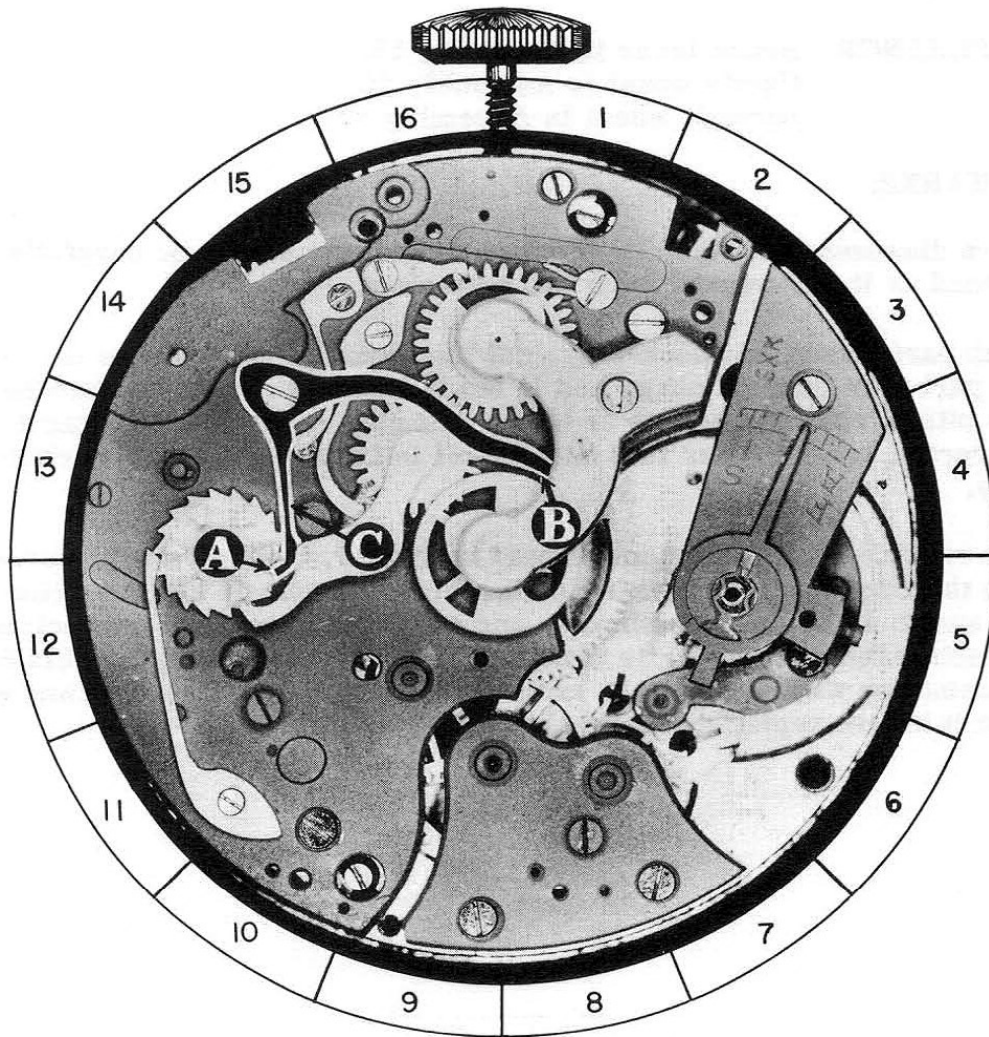

15-A

PART NO. 16

A. DISASSEMBLY PROCEDURE OF BRAKE LEVER SPRING:

This spring is held in place by beveled countersink screw BS-6 and a steady pin. After screw is removed, spring may be lifted from movement.

(The shape of screw for this part is shown at bottom of page.)

B. ASSEMBLY PROCEDURE OF BRAKE LEVER SPRING:

Place spring in position on plate as shown in photograph with steady pin in proper hole in plate. Now replace beveled countersink screw BS-6 to hold spring in position.

C. FUNCTION OF BRAKE LEVER SPRING:

The function of this spring is to engage end "B" of brake lever with the seconds wheel and to hold it engaged until it is disengaged by the castle wheel.

REFERENCE: Brake lever is Assembly 15.
Castle wheel is Assembly 26.
Seconds wheel is Assembly 19.

REMARKS:

When disassembling the chronograph, each part should be carefully examined as it is removed from the movement.

Each part should be checked against the isometric drawing to see that the part is of correct shape and is not broken. It should be checked for any pits of rust, roughness or burrs that may cause it not to function correctly, and for wear that may result in failure of part to work properly.

The replacement of a defective part in the chronograph may necessitate the complete disassembly of the chronograph. It will save time in the end to make this examination and make the necessary corrections to each defective part while disassembling the chronograph. This close examination will soon enable you to recognize a defective part and correct it before replacing in the chronograph.

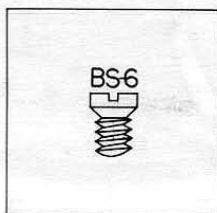

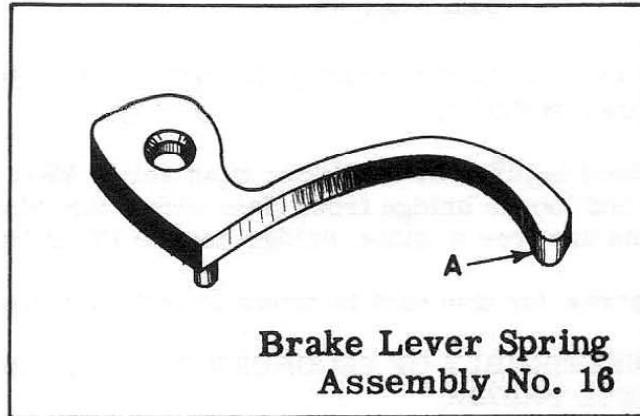

OILING

End "A" of brake lever spring should be slightly moistened with oil at the point it contacts brake lever.

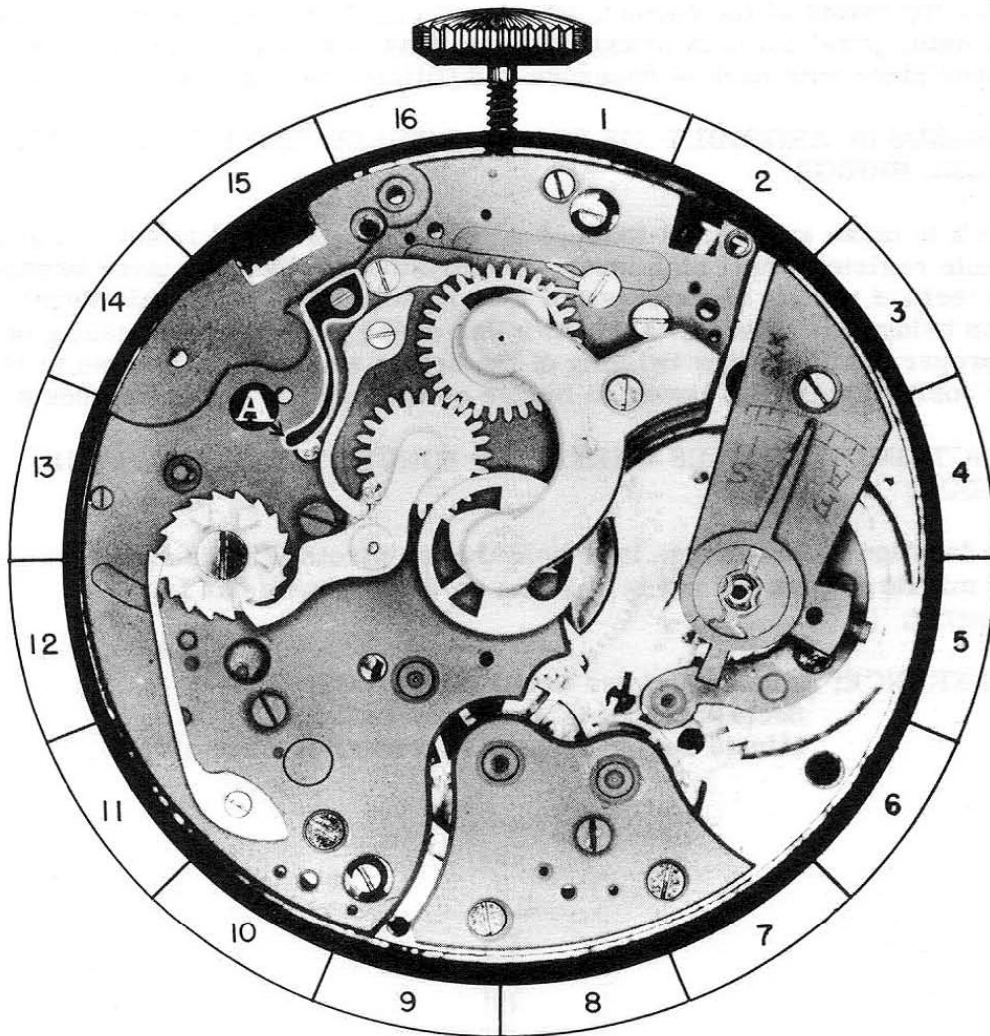

PART NO. 17

A. DISASSEMBLY PROCEDURE OF SECONDS WHEEL AND MINUTE REGISTER WHEEL BRIDGE:

This bridge is held in place by a fillister head screw FS-1 and steady pins. Remove screw and loosen bridge from plate with a thin blade screwdriver. When steady pins are free in plate, bridge may be lifted from movement.

(The shape of screw for this part is shown at bottom of page.)

B. HAZARDS IN DISASSEMBLY OF SECONDS WHEEL AND MINUTE REGISTER WHEEL BRIDGE:

When loosening bridge from plate, avoid twisting bridge as this may damage pivots on wheels or may chip jewels in bridge. The screwdriver should be carefully used to prevent marring of bridge or plate.

C. ASSEMBLY PROCEDURE OF SECONDS WHEEL AND MINUTE REGISTER WHEEL BRIDGE:

Place bridge on plate with the steady pins over proper holes in plate. Place top pivots of the seconds wheel and minute register wheel so they will enter jewel holes in bridge. Bridge may now be pressed down to proper place with back of tweezers and fillister head screw FS-1 replaced.

D. HAZARDS IN ASSEMBLY OF SECONDS WHEEL AND MINUTE REGISTER WHEEL BRIDGE:

Check to make sure that a tooth of minute register wheel is not on top of minute register wheel stop lever. Failure to have the stop lever between two teeth of minute register wheel may result in bending of this wheel when bridge is replaced. Avoid twisting of the bridge when pressing down to proper position. Any twisting of the bridge when pressing down to proper position may chip jewels in bridge or damage the pivots on wheels.

E. FUNCTION OF SECONDS WHEEL AND MINUTE REGISTER WHEEL BRIDGE:

The function of this bridge is to hold the top pivots of the seconds wheel and minute register wheel in position so these wheels can function properly.

REFERENCE: Minute register wheel is Assembly 18.
Seconds wheel is Assembly 19.
Minute register wheel stop lever is Assembly 21.

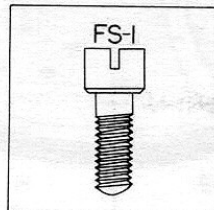

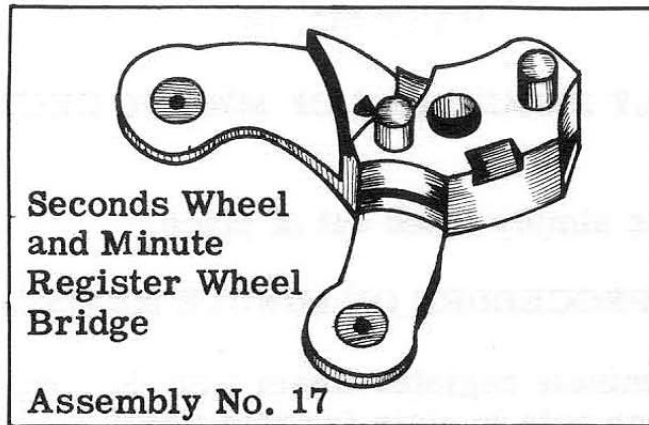

OILING

The pivots in the jewels in this bridge should be oiled as you would properly oil a train pivot in a watch.

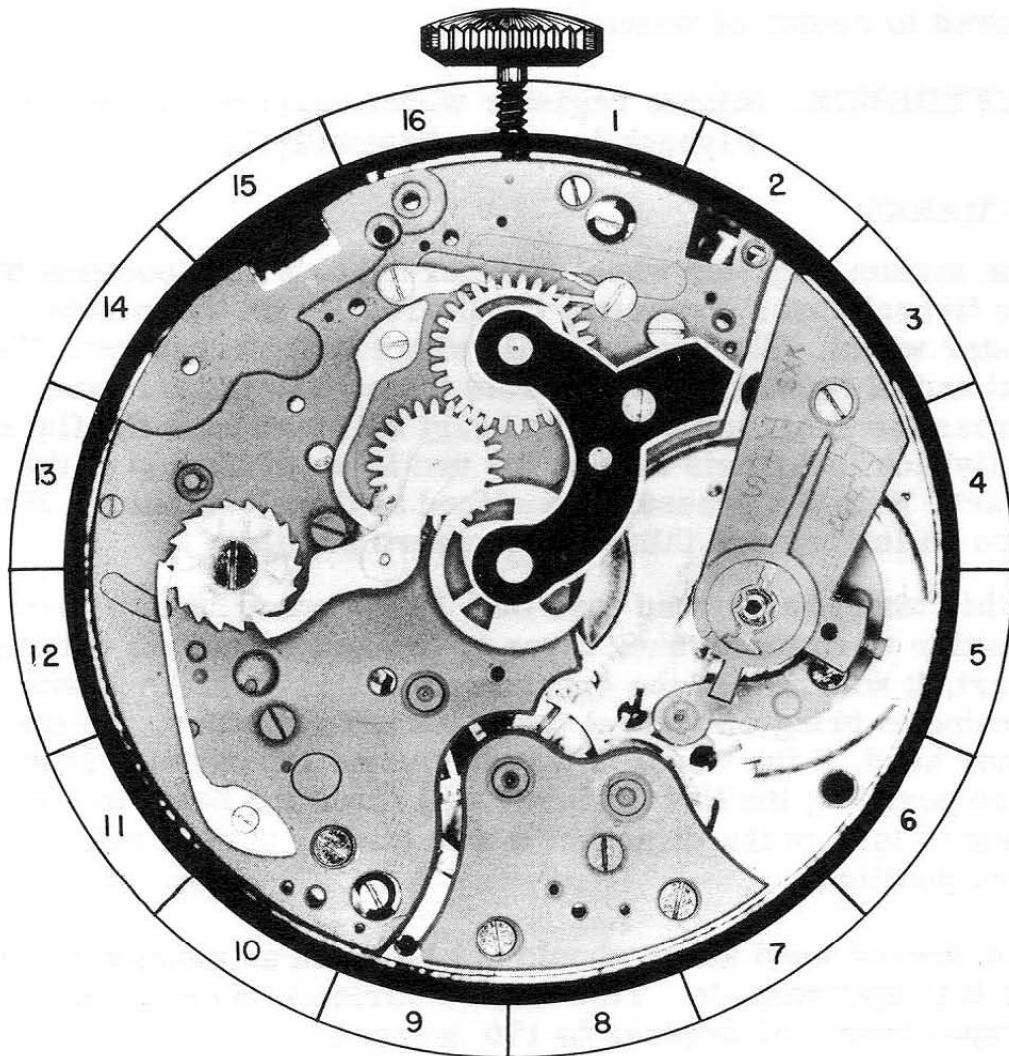

PART NO. 18

A. DISASSEMBLY PROCEDURE OF MINUTE REGISTER WHEEL:

This wheel is simply lifted out of place.

B. ASSEMBLY PROCEDURE OF MINUTE REGISTER WHEEL:

Replace the minute register wheel with the long post "A" down in proper hole in plate for this wheel.

C. FUNCTION OF MINUTE REGISTER WHEEL:

The function of this wheel is to register the number of minutes on the dial that have elapsed since the beginning of the registration. Also the heart "B" on this wheel returns the wheel and hand to a zero position when the flyback lever is moved to center of watch.

REFERENCE: Minute register wheel heart is Assembly 18-B.
Flyback lever is Assembly 12.

REMARKS:

The minute register wheel is returned to a zero position by the flyback lever contacting the heart "B" on the minute register wheel. The heart on this wheel is set eccentric. The flat end of flyback lever contacts the eccentric heart and forces the heart to turn. The heart will turn until the flat end of flyback lever sets across the two lobes at the top of the heart. With the pressure equalized at these two points, it will turn no further and this will be a zero position.

If this wheel has turned less than 160 degrees from a zero position when the flyback lever is brought in contact with the heart, it will turn in the opposite direction to which it was turning to bring this wheel back to a zero position. On the other hand, if the wheel is turned passed 160 degrees from a zero position, the flyback lever will force the heart to continue to turn in the direction it was turning until it reaches a zero position.

The degree used above should not be taken as exactly correct, as it is approximate. This degree varies in most chronographs from 150 degrees to 170 degrees.

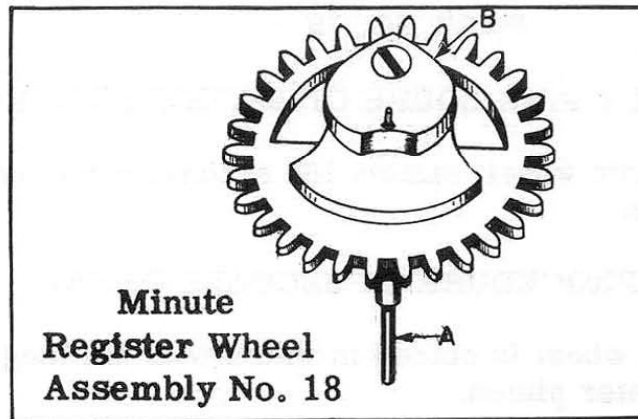

OILING

The bottom pivot of minute register wheel should be oiled as you would properly oil a train pivot in a watch. The top pivot should be oiled after bridge for wheel is placed in watch.

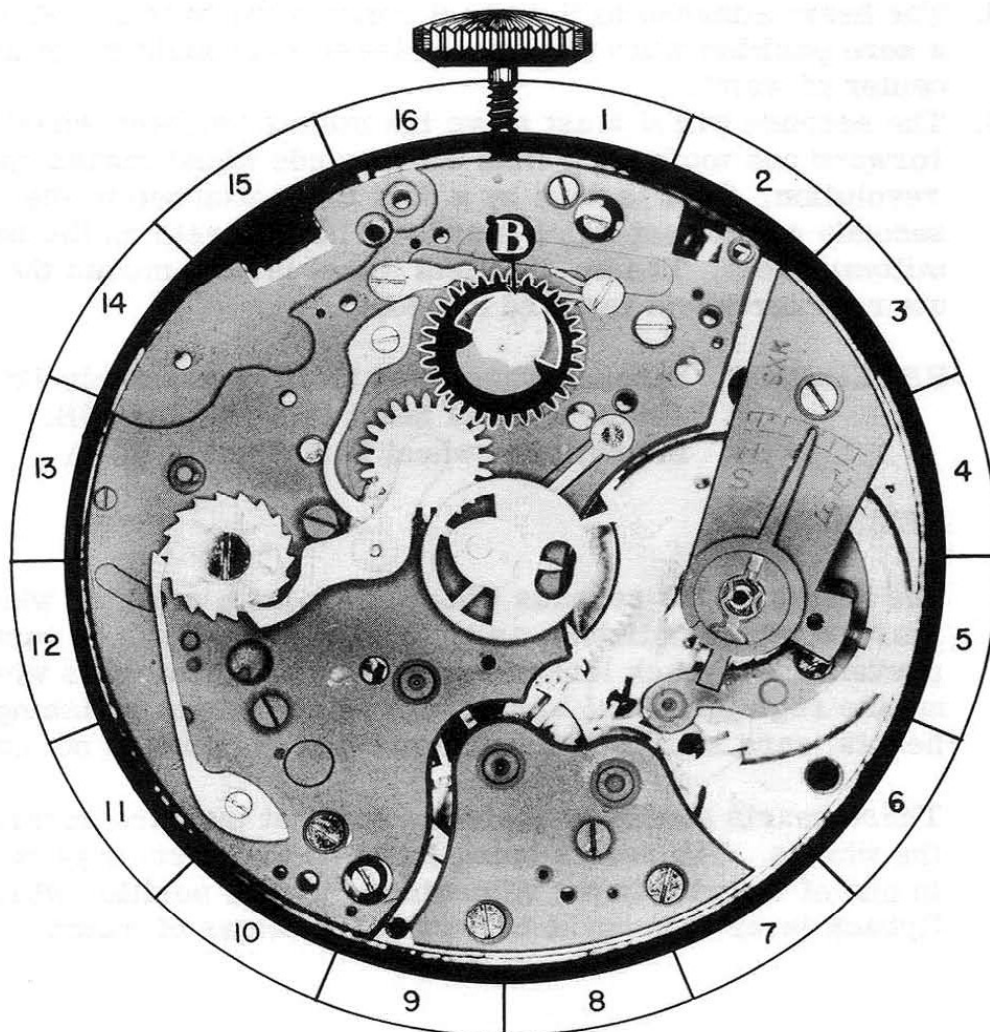

18-A

PART NO. 19

A. DISASSEMBLY PROCEDURE OF SECONDS WHEEL:

To remove this wheel, simply lift seconds wheel post out of hollow center pinion.

B. ASSEMBLY PROCEDURE OF SECONDS WHEEL:

The seconds wheel is placed in watch with the long post "A" down in hollow center pinion.

C. FUNCTION OF SECONDS WHEEL:

The function of the seconds wheel is to do three things:

1. The hand attached to this wheel registers on the dial the seconds that have elapsed since the beginning of the registration.
2. The heart attached to the wheel returns the hand and wheel to a zero position when the flyback lever is brought in toward the center of watch.
3. The seconds wheel must move the minute register wheel forward one tooth each time the seconds wheel makes one revolution. This is done by a dart tooth attached to the seconds wheel post which meshes with the teeth on the intermittent wheel. The intermittent wheel in turn moves the minute register wheel forward one tooth.

REFERENCE: Seconds wheel dart tooth is Assembly 19C.
Seconds wheel heart is Assembly 19B.
Intermittent wheel is Assembly 24-A

REMARKS:

The hearts on the seconds wheel and minute register wheel must be highly polished, as any roughness or pits of rust may prevent the flyback lever from returning the seconds wheel or minute register wheel to a zero position. When polishing these hearts, care should be taken that shape of heart is not changed.

These hearts should be tested to see that they are secure to the wheels. The hearts being loose on the wheel may result in one of the wheels not returning to a zero position when the flyback lever is brought in toward the center of watch.

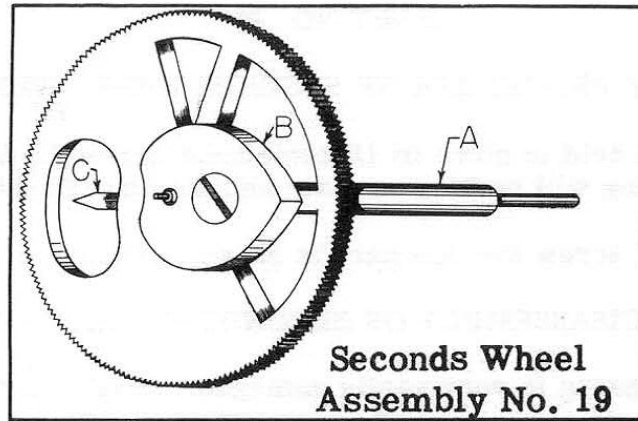

OILING

The top pivot of the seconds wheel should be oiled after bridge for this wheel is placed in watch. Do not oil bottom pivot.

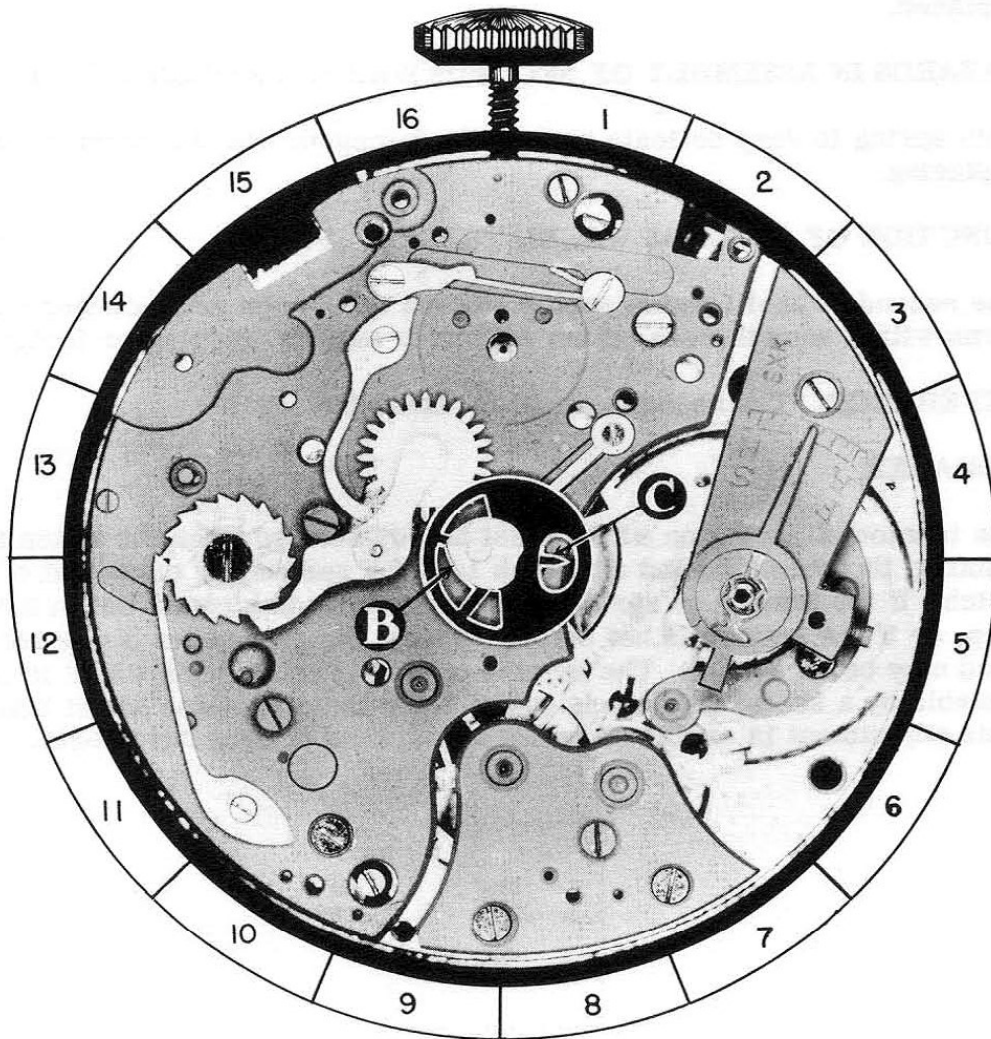

19-A

PART NO. 20

A. DISASSEMBLY PROCEDURE OF SECONDS WHEEL TENSION SPRING:

This spring is held in place by fillister head screw FS-2. After screw is removed, spring will be free on plate and may be lifted from movement.

(The shape of screw for this part is shown at bottom of page.)

B. HAZARDS IN DISASSEMBLY OF SECONDS WHEEL TENSION SPRING:

This tension spring is very easily damaged. Handle very carefully to prevent bending.

C. ASSEMBLY PROCEDURE OF THE SECONDS WHEEL TENSION SPRING:

The tension spring is placed on plate with hole in spring over proper hole in plate. Be sure spring is right side up. The highly polished end "A" of spring should be up. Now replace fillister head screw FS-2, but before tightening screw make sure that end "A" of spring is not over center hole far enough to touch post of seconds wheel when this wheel is replaced.

D. HAZARDS IN ASSEMBLY OF SECONDS WHEEL TENSION SPRING:

This spring is very delicate and easily damaged. Handle carefully when replacing.

E. FUNCTION OF SECONDS WHEEL TENSION SPRING:

The seconds wheel tension spring holds a tension on seconds wheel so it turns with a smooth even action with no irregular jumping or jerking.

REFERENCE: The seconds wheel is Assembly 19.

REMARKS:

The tension of spring on wheel must be adjusted so when the watch is running, the seconds hand advances $1/5$ of a second for each beat of the watch. If the tension of spring is too strong, it may cause the watch to stop, or if the tension is not strong enough, the movement of the seconds hand may be irregular. The tension of spring on seconds wheel is adjustable by a screw in seconds wheel and minute register wheel bridge. This adjustment is explained under adjustment of eccentric studs.

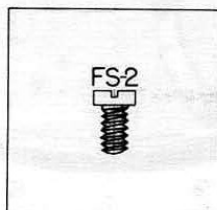

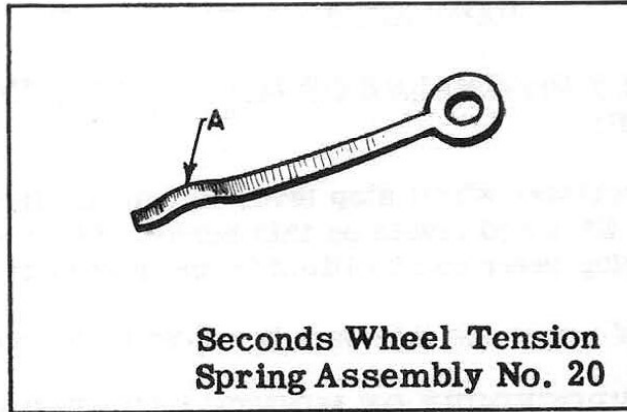

OILING

The seconds wheel tension spring should not be oiled.

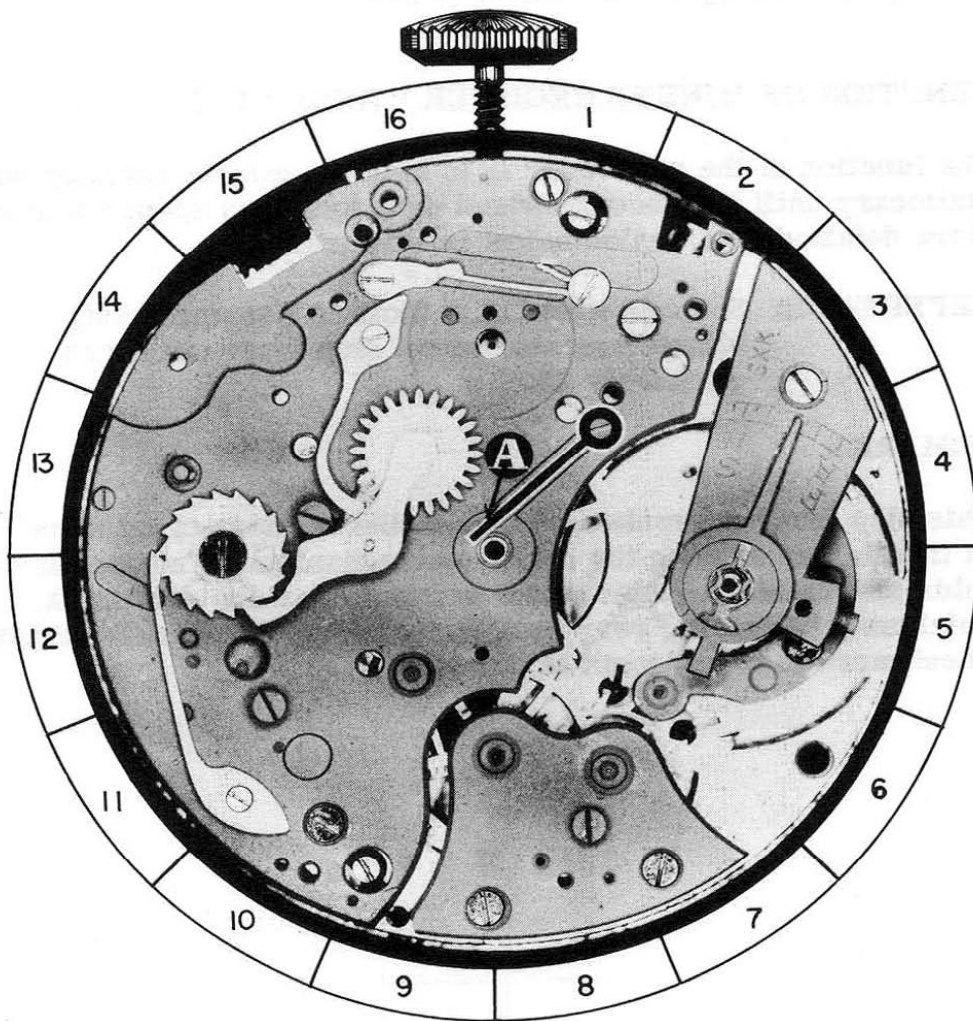

20-A

PART NO. 21

A. DISASSEMBLY PROCEDURE OF MINUTE REGISTER WHEEL STOP LEVER:

The minute register wheel stop lever is held in place by shouldered screw SS-6 and pivots on this screw. After screw is removed, the stop lever can be lifted from movement.

(The shape of screw for this part is shown at bottom of page.)

B. ASSEMBLY PROCEDURE OF MINUTE REGISTER WHEEL STOP LEVER:

Place stop lever in position with end "A" of pin down in hole in plate. The pin "A" must be placed so that the minute register stop lever spring forces stop lever toward the center of the watch. Hold lever in place with finger and replace shouldered screw SS-6 to hold stop lever in place. Check to see that stop lever pivots freely under head of screw.

C. FUNCTION OF MINUTE REGISTER WHEEL STOP LEVER:

The function of the stop lever is to hold the minute register wheel stationary until the seconds wheel dart tooth has spent its force. More detailed explanation below in Remarks.

REFERENCE: Seconds wheel dart tooth is Assembly 19C.
Minute register wheel stop lever spring is Assembly 22.

REMARKS:

This stop lever prevents an error in the register of minutes on the dial when using the catch-up mechanism. The stop lever holds the minute register wheel stationary so the dart tooth, which may be turning very fast, cannot move the minute register wheel more than one tooth at this time.

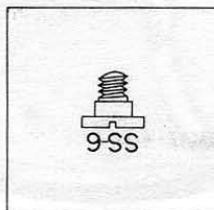

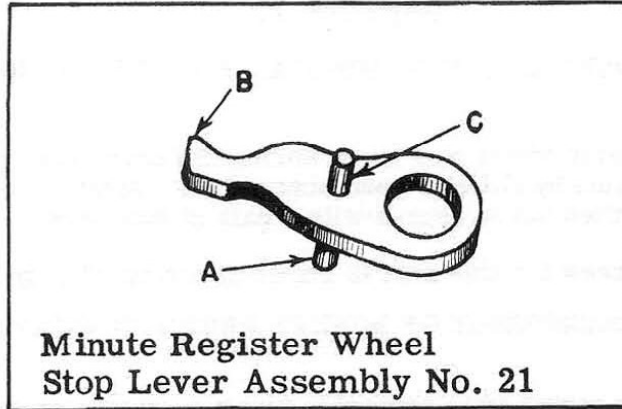

OILING

The shoulder of screw that the minute register wheel stop lever pivots on should be slightly moistened with oil.

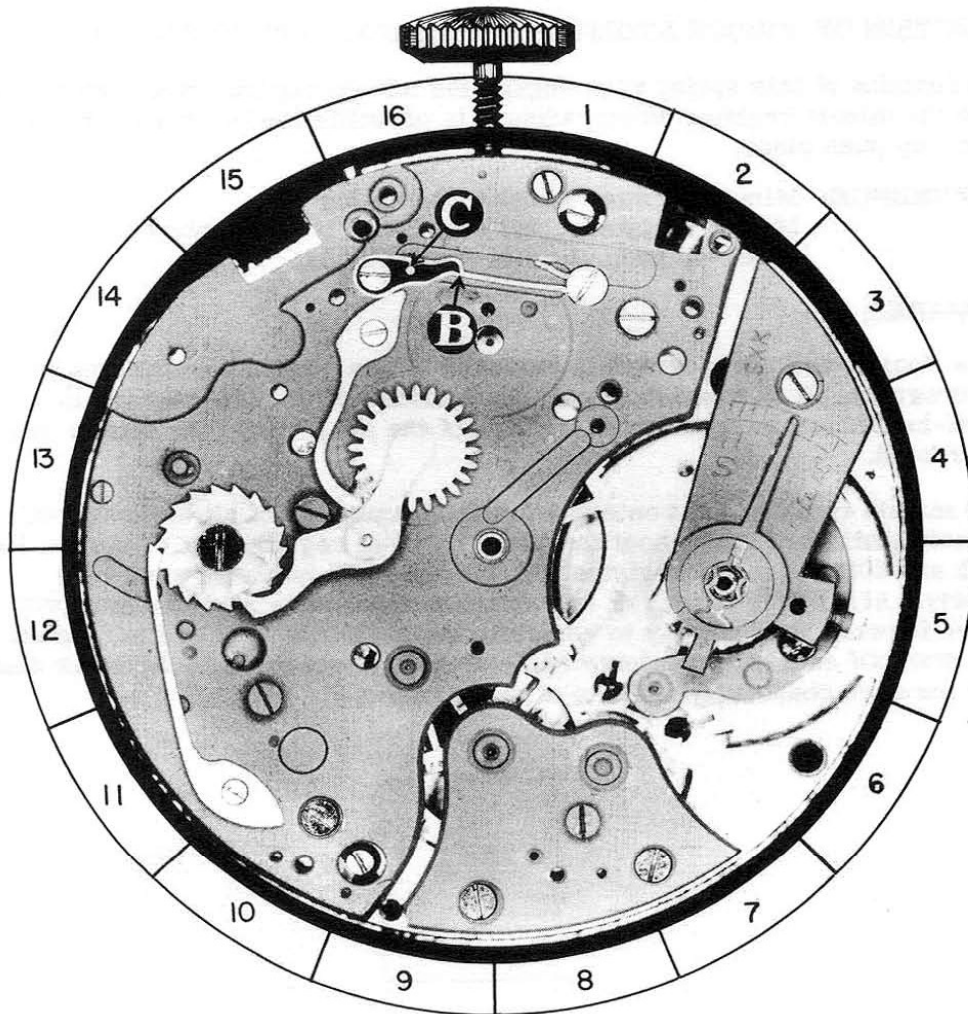

21-A

PART NO. 22

A. DISASSEMBLY PROCEDURE OF MINUTE REGISTER WHEEL STOP LEVER SPRING:

The minute register wheel stop lever spring fits down in a recess in plate and is held in place by fillister head screw FS-3. After screw is removed, spring may be lifted out of recess with a pair of tweezers.

(The shape of screw for this part is shown at bottom of page.)

B. HAZARDS IN DISASSEMBLY OF MINUTE REGISTER WHEEL STOP LEVER SPRING:

Hold finger over spring when removing screw so spring or screw are not lost.

C. ASSEMBLY PROCEDURE OF MINUTE REGISTER WHEEL STOP LEVER SPRING:

Place the spring in position as shown in photograph. Place part "C" of spring around screw hole in recess in plate with end "B" of spring toward outside of watch. Now place the end "A" of spring in place and replace fillister head screw FS-3 to hold spring in position.

D. FUNCTION OF MINUTE REGISTER WHEEL STOP LEVER SPRING:

The function of this spring is to engage the minute register wheel stop lever with the minute register wheel, when it is permitted to be engaged by the catch-up push piece.

REFERENCE: Minute register wheel is Assembly 18.
Minute register wheel stop lever is Assembly 21.
Catch-up push piece is Assembly 14.

REMARKS:

This "catch-up" chronograph is basically a semi-instantaneous type of chronograph. It is possible to note immediately if the chronograph is a semi-instantaneous type by observation of the progress of the minute register hand.

The minute register hand on semi-instantaneous type of chronograph will remain stationary until about the 58th second of registration. Between the 58th and 60th second of registration, the hand will move forward very slowly. At the 60th second of registration, the minute register hand will move forward very quickly to complete the registration of one minute on the dial. Of course, the minute register hand progresses in the same manner for each consecutive minute of registration.

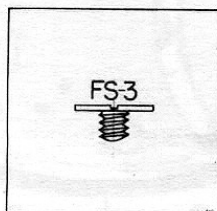

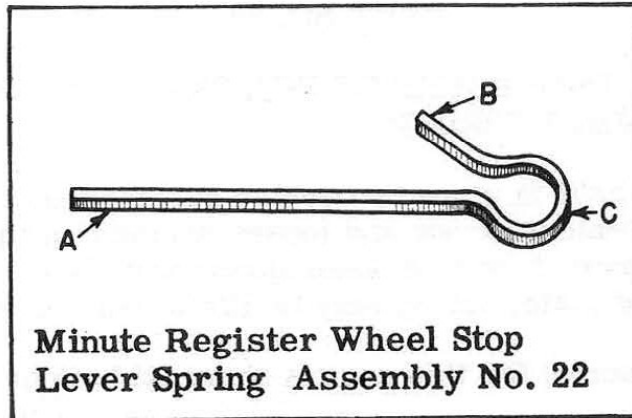

OILING

End "A" of spring should be slightly moistened with oil at point it contacts pin "A" on minute register wheel stop lever.

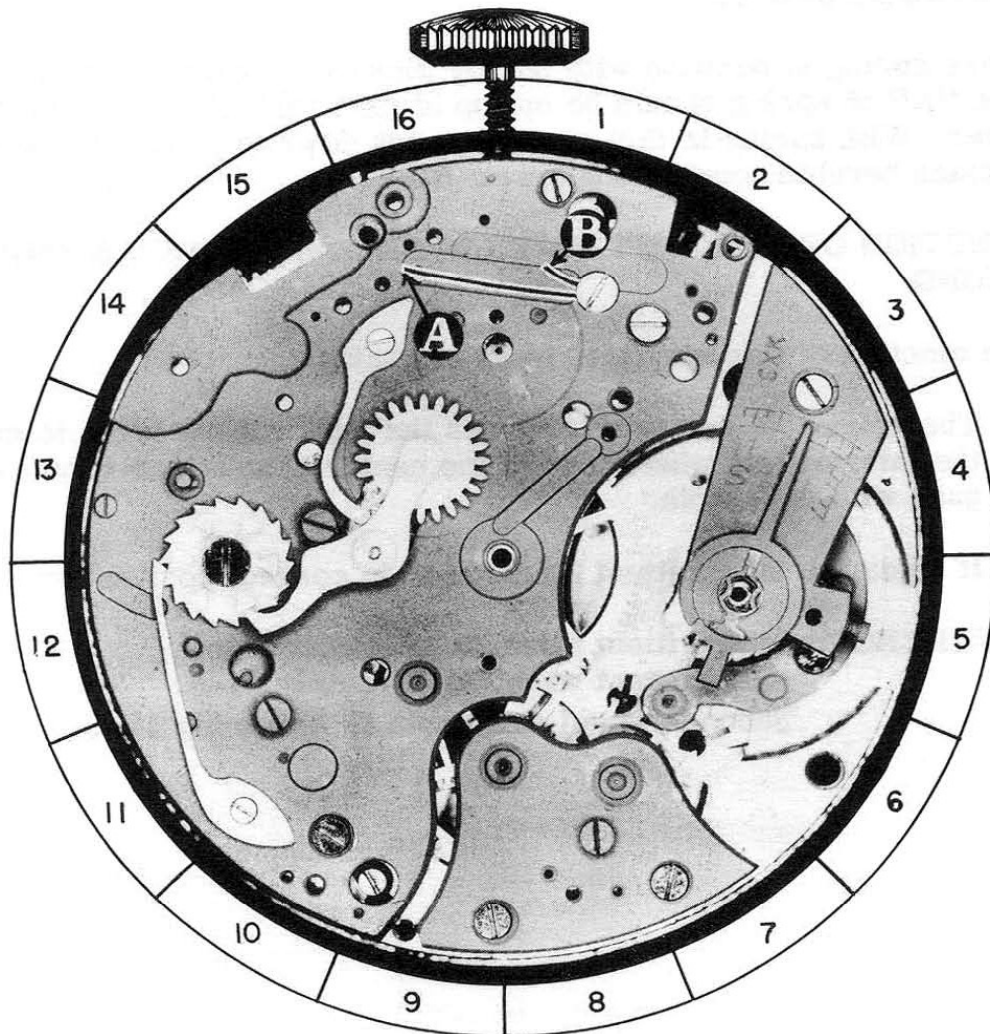

22-A

PART NO. 23

A. DISASSEMBLY PROCEDURE OF INTERMITTENT LEVER AND WHEEL ASSEMBLY SPRING:

This spring is held in place by beveled countersink screw BS-7 and steady pins. Remove screw and loosen spring from plate by sliding a thin blade screw-driver between spring and plate. When steady pins are free of plate, spring may be lifted from movement.

(The shape of screw for this part is shown at bottom of page.)

B. HAZARDS IN DISASSEMBLY OF INTERMITTENT LEVER AND WHEEL ASSEMBLY SPRING:

Hold finger over spring while removing screw and loosening spring from plate to prevent loss of screw or spring.

C. ASSEMBLY PROCEDURE OF INTERMITTENT LEVER AND WHEEL ASSEMBLY SPRING:

Place spring in position with steady pins over proper holes in plate. End "A" of spring should be on top of part "B" of intermittent lever. With spring in this position, push down to proper place and replace beveled countersink screw BS-7.

D. FUNCTION OF INTERMITTENT LEVER AND WHEEL ASSEMBLY SPRING:

The function of this spring is to do two things:

1. The tension of this spring forces the intermittent lever to move the intermittent wheel toward the center of watch so it will engage with dart tooth.
2. It holds the intermittent lever down in correct position on post.

REFERENCE: Intermittent lever is Assembly 24.
Intermittent wheel is Assembly 24-A.
Seconds wheel dart tooth is Assembly 19-C.

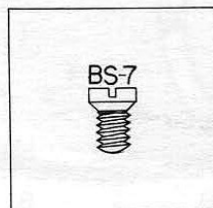

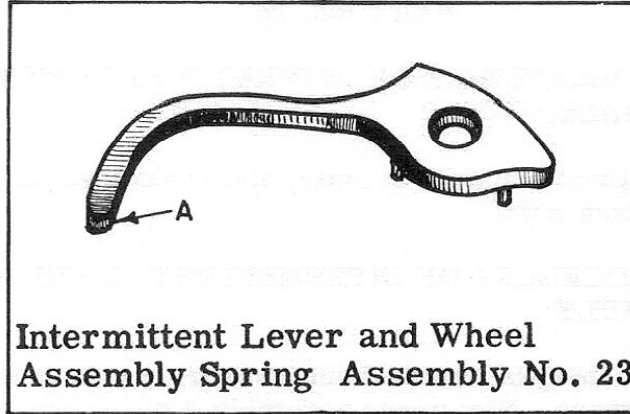

OILING

End "A" of spring should be slightly moistened with oil at the point it contacts intermittent lever and wheel assembly.

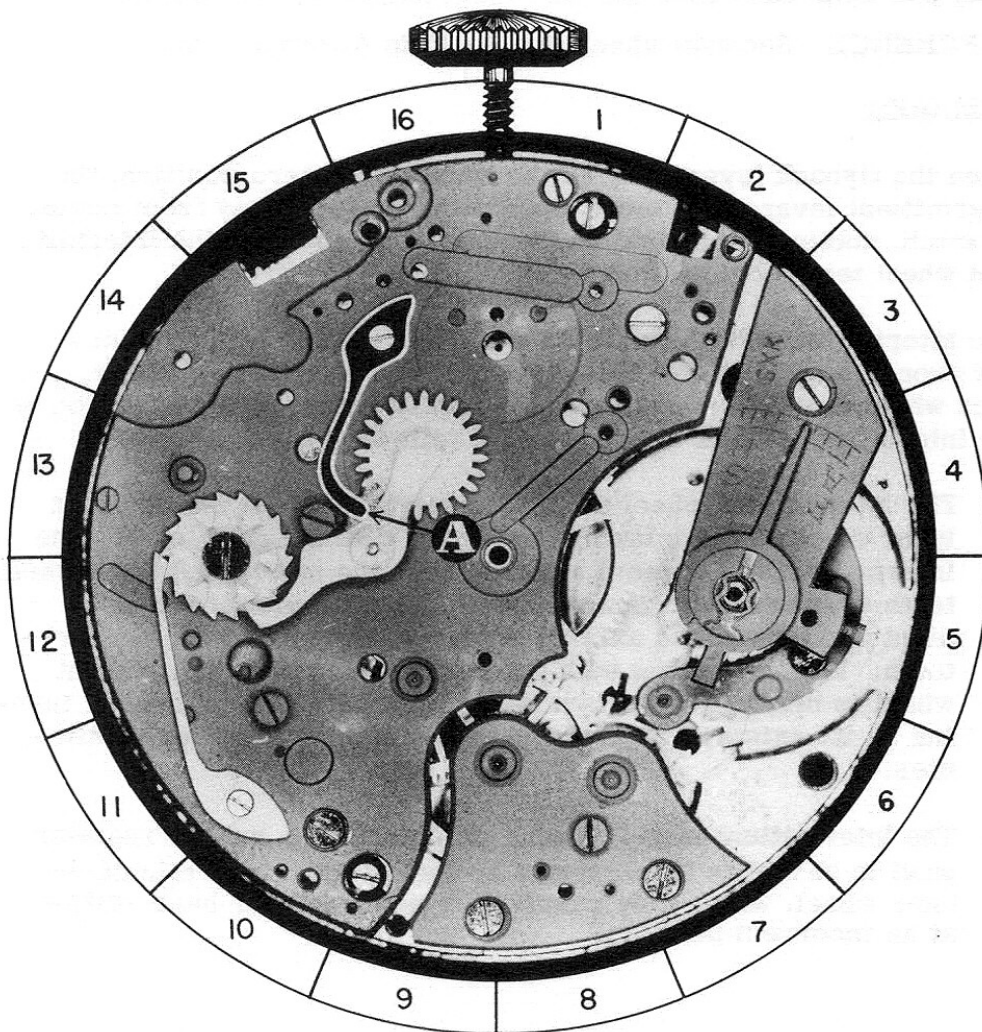

23-A

PART NO. 24

A. DISASSEMBLY PROCEDURE OF INTERMITTENT LEVER AND WHEEL ASSEMBLY:

This assembly pivots on post in plate, and to remove it, lift intermittent lever from post.

B. ASSEMBLY PROCEDURE OF INTERMITTENT LEVER AND WHEEL ASSEMBLY:

Place hole in bushing in intermittent lever over post in plate as shown in photograph. Now press assembly down on post to proper place. Assembly should pivot freely on post.

C. FUNCTION OF INTERMITTENT LEVER AND WHEEL ASSEMBLY:

The function of the intermittent lever is to engage and disengage the intermittent wheel with the seconds wheel dart tooth.

The function of the intermittent wheel is to turn the minute register wheel one tooth each time the dart tooth makes one revolution.

REFERENCE: Seconds wheel dart tooth is Assembly 19C.

REMARKS:

When the flyback lever returns the wheels to a zero position, the intermittent lever must move intermittent wheel away from center of watch, making it impossible for dart tooth to touch the intermittent wheel teeth at this time.

The intermittent wheel should be carefully checked to see that it has proper endshake and spins freely in the intermittent lever. This wheel must, of necessity, spin freely as any excess friction on the intermittent wheel may cause the following errors:

1. The intermittent wheel must turn slightly as the intermittent lever engages the intermittent wheel with the dart tooth. The intermittent wheel teeth meshing with the minute register wheel teeth which are stationary causes the intermittent wheel to pivot and turn on its axis as it moves to engage with the dart tooth. When engaging with the dart tooth, if the intermittent wheel is binding, it turns minute register wheel instead of turning on its axis and may result in an error in register of minutes.
2. The intermittent wheel binding may cause the minute register pawl to be unable to correctly space the turning of minute register wheel, which may result in minute register hand setting at an incorrect position.

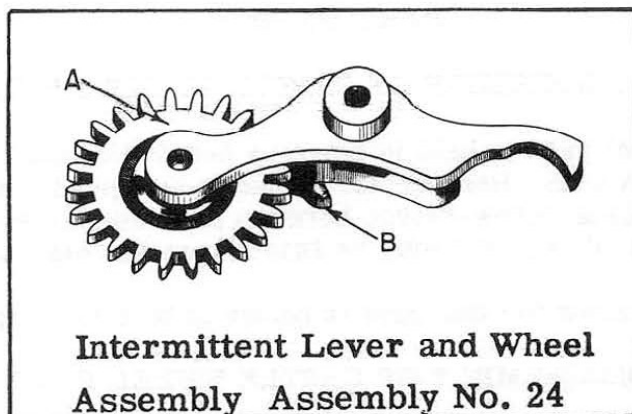

OILING

The post that intermittent lever and wheel assembly pivots on should be slightly moistened with oil.

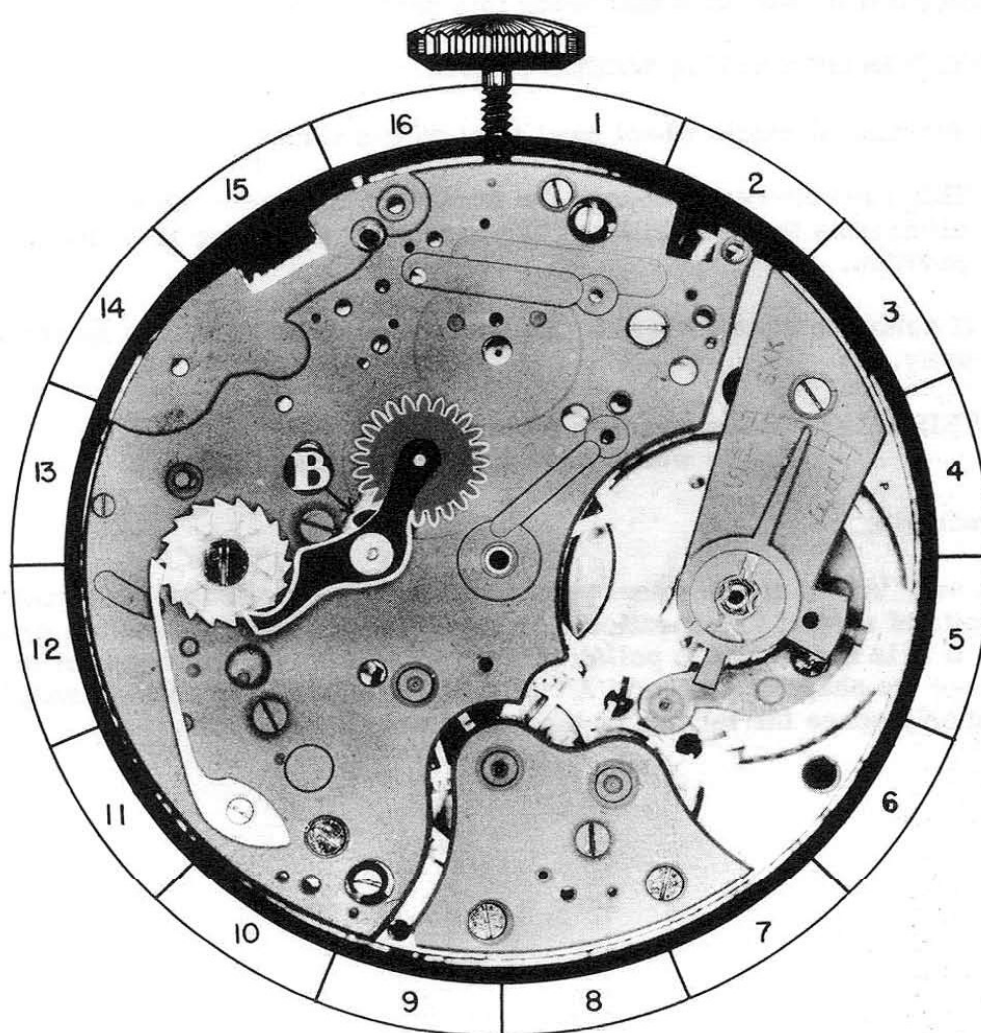

24-A

PART NO. 25

A. DISASSEMBLY PROCEDURE OF CASTLE WHEEL PAWL:

The castle wheel pawl is held in place by beveled countersink screw BS-8 and steady pins. Remove screw and loosen pawl from plate by sliding a thin blade screw-driver between pawl and plate. After steady pins are free in plate, pawl may be lifted from movement.

(The shape of screw for this part is shown at bottom of page.)

B. HAZARDS IN DISASSEMBLY OF CASTLE WHEEL PAWL:

Hold finger over pawl when removing screw and loosening steady pins in plate to prevent loss of screw or pawl.

C. ASSEMBLY PROCEDURE OF CASTLE WHEEL PAWL:

Place the castle wheel pawl on plate with steady pins over proper holes in plate. Now press pawl down on plate. End "A" of pawl should be between two ratchet teeth "B" on castle wheel. Now replace beveled countersink screw BS-8 that holds this part in place.

D. FUNCTION OF CASTLE WHEEL PAWL:

The function of castle wheel pawl is to do two things:

1. This pawl correctly spaces the turning of the castle wheel. This eliminates the possibility of the castle wheel setting at an incorrect position.
2. It holds the castle wheel in the correct position until it is moved manually.

REFERENCE: Castle wheel is Assembly 26.
Castle wheel ratchet teeth is Assembly 26-B.

REMARKS:

The end "A" of castle wheel pawl must be highly polished. Any roughness or pits of rust at this location may cause the pawl not to function properly. If it is necessary to polish this part, care should be taken not to change the shape of the end "A" of pawl. It must be of correct shape to properly space the turning of the castle wheel.

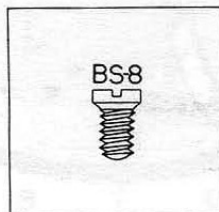

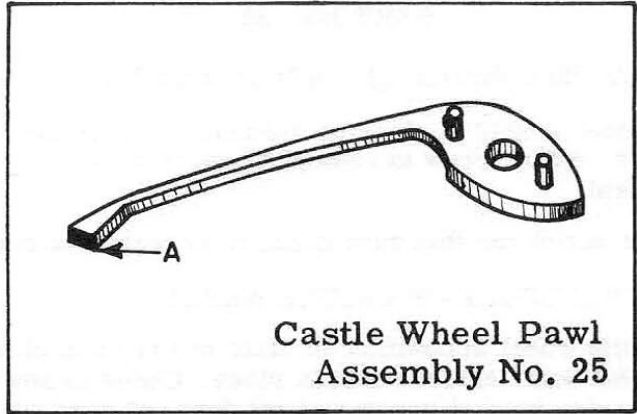

Castle Wheel Pawl
Assembly No. 25

OILING

The castle wheel pawl should not be oiled.

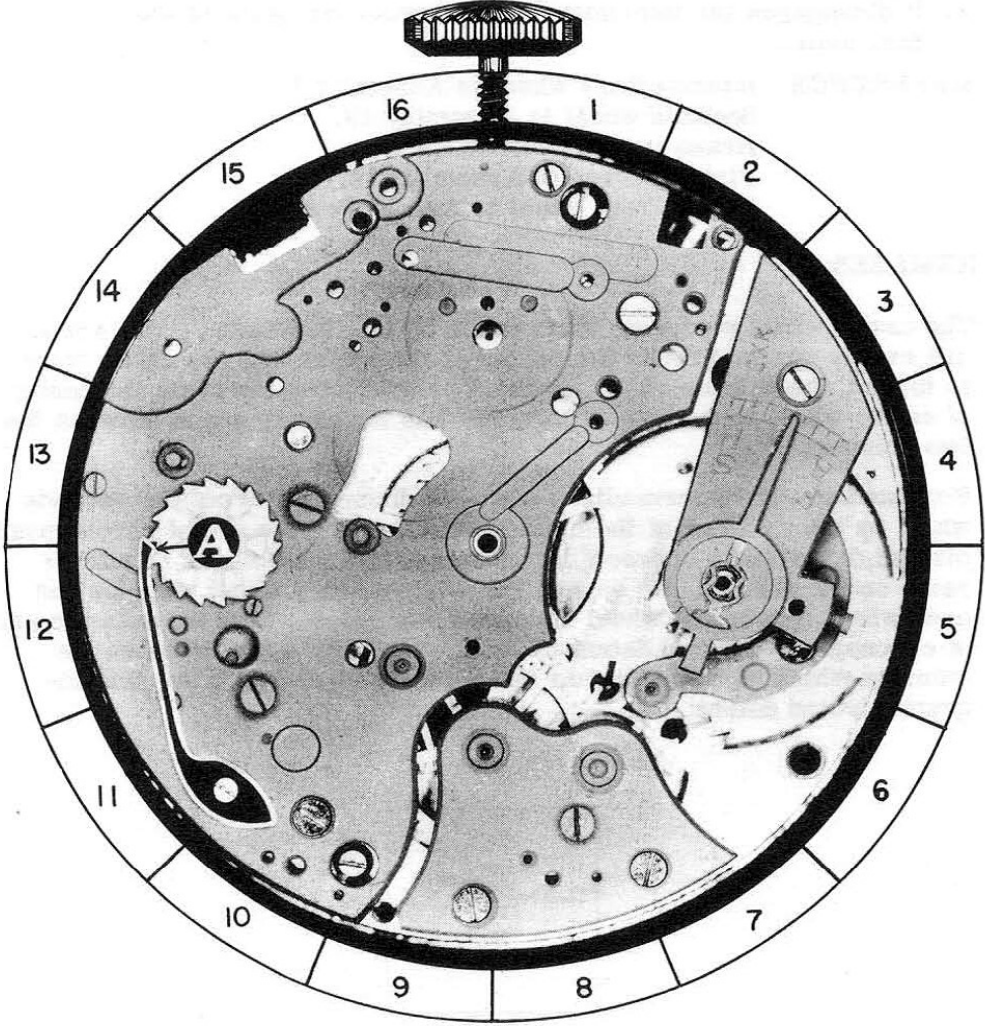

25-A

PART NO. 26

A. DISASSEMBLY PROCEDURE OF CASTLE WHEEL:

The castle wheel is held in place by shouldered screw SS-7 and pivots on this screw. After screw is removed, castle wheel may be lifted from movement.

(The shape of screw for this part is shown at bottom of page.)

B. ASSEMBLY PROCEDURE OF CASTLE WHEEL:

Place the castle wheel in position on plate and replace shouldered screw SS-7 that holds castle wheel in place. Check to see that wheel turns freely under head of screw and yet does not have excessive end-shake or side shake.

C. FUNCTION OF THE CASTLE WHEEL:

The function of the castle wheel is to do four things:

1. It disengages the intermediary wheel from the seconds wheel.
2. It disengages the brake lever from the seconds wheel.
3. It disengages the flyback lever from the hearts on minute register wheel and seconds wheel.
4. It disengages the intermittent wheel from the seconds wheel dart tooth.

REFERENCE: Intermediary wheel is Assembly 5.
Seconds wheel is Assembly 19.
Brake lever is Assembly 15.
Flyback lever is Assembly 12.
Intermittent wheel is Assembly 24-A.

REMARKS:

The castle wheel performs its function by the "columns" "A" which are evenly spaced around the center of the wheel. As the castle wheel is turned, the column either forces a part to move out from the center of castle wheel or permits it to move into the empty space between the two columns.

For example, the intermediary wheel is disengaged from the seconds wheel by the columns of the castle wheel forcing the end of chronograph pivoted detent from between the columns until the point of this lever rests on the column. To engage the intermediary wheel with the seconds wheel, the castle wheel is turned one space. This permits the end of chronograph pivoted detent to enter the empty space between the columns which permits the two wheels to be engaged by the chronograph pivoted detent.

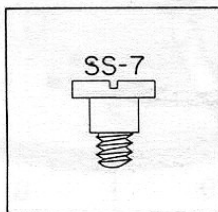

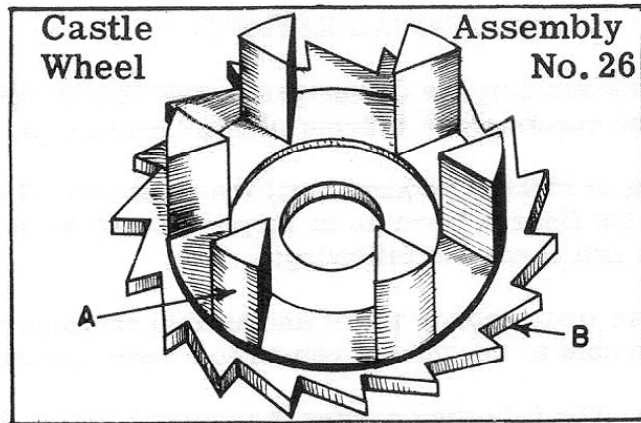

OILING

- These parts of castle wheel should be slightly moistened with oil:
1. The shoulder of screw that castle wheel pivots on.
 2. The columns "A" at points of contact with parts of chronograph mechanism.
 3. The ratchet teeth "B" should be slightly moistened with oil.

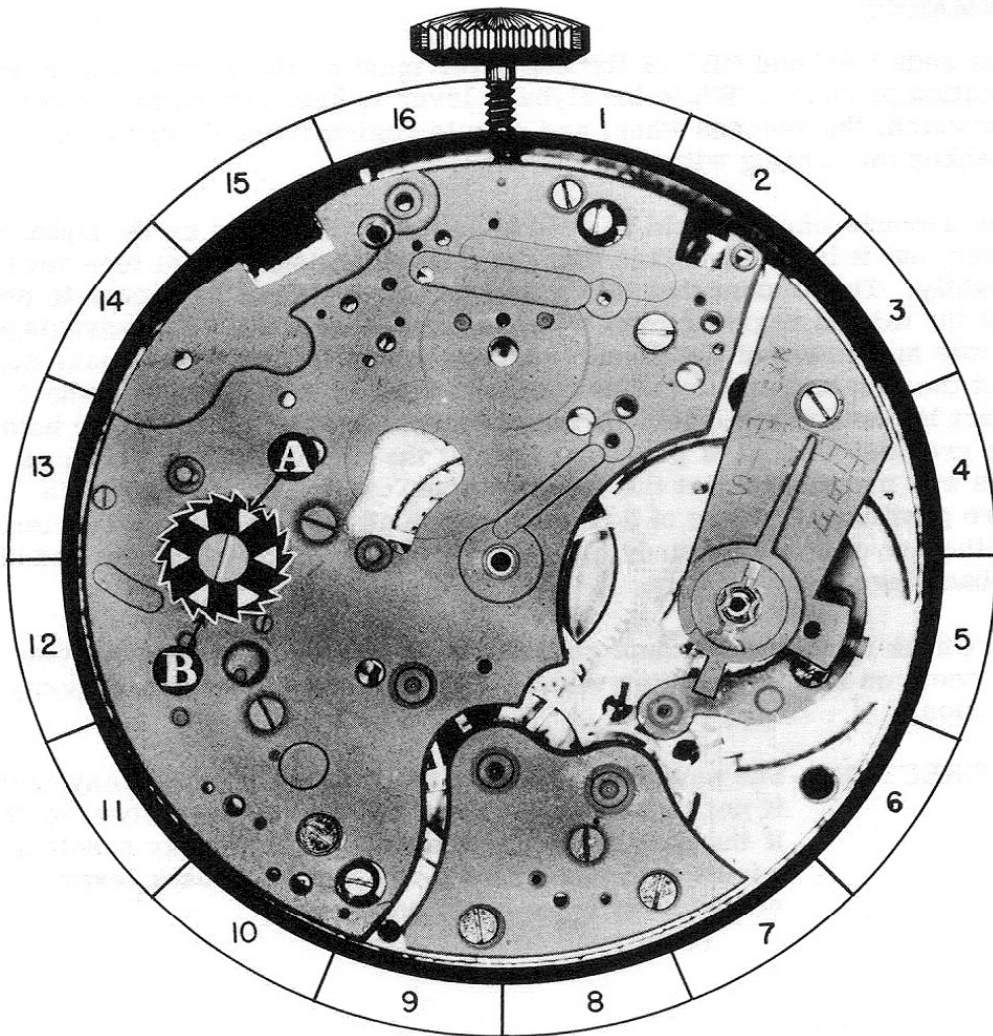

FUNCTIONAL RESULTS

After completely assembling the chronograph with the exception of the back of case, place chronograph in front of you, pendant up.

1. Push the button at right of pendant until the castle wheel is in a position to permit the flyback lever to be forced toward center of watch. Release button and check the following:
 - A. Check to see that seconds wheel and minute register wheel and the hands connected to the wheels return to a zero position.

CORRECTION: The following errors may prevent these hands from returning to a zero position:

1. Loose hands or hands not being set correctly.
2. The minute register wheel or the seconds wheel binding and not turning freely.
3. The branches "A" or "B" of flyback lever not being of correct length to return one of the wheels to zero.
4. Flyback lever spring not holding a strong enough tension on flyback lever.

REMARKS:

The ends "A" and "B" of flyback lever must be the correct length to function properly. While the flyback lever is held toward the center of the watch, the seconds wheel and minute register wheel should be checked for turning with a fine broach.

The seconds wheel should be held absolutely stationary by the flyback lever, but it is an advantage that the minute register wheel turn very slightly. The amount that this wheel turns should not be enough to permit the minute register pawl to move to another tooth. The advantage of this movement of the minute register wheel is that it will make sure that the greatest amount of pressure is applied to the seconds wheel heart by the flyback lever. It is important that the flyback lever holds the greatest amount of pressure against the seconds wheel heart, as this will make sure that the seconds wheel will always return to a zero position. The use of a fine broach is advised in making this test, as the use of a more sturdy tool may cause the heart to lift the end of flyback lever.

- B. Check to see that minute register pawl lies directly between two teeth on minute register wheel when this wheel is at a zero position.

CORRECTION: The pawl being bent or improperly adjusted may cause it not to set correctly on minute register wheel teeth. If the pawl is not adjusted properly, it may result in minute register wheel moving after flyback lever moves away from heart on wheel.

(Continued on next page)

FUNCTIONAL RESULTS
(Continued)

2. Push button to right of pendant. Release it and check the following:

A. Check the depthing of teeth on intermediary wheel with teeth on seconds wheel.

CORRECTION: The following errors could prevent the proper depthing of these teeth:

1. Chronograph pivoted detent spring not holding enough tension on chronograph pivoted detent.
2. Chronograph pivoted detent binding and not turning freely.
3. Improperly adjusted eccentric studs may prevent proper depthing of these teeth. (See adjustment of eccentric studs.)

B. Check depthing of seconds wheel dart tooth with intermittent wheel teeth.

CORRECTION: The following errors could prevent proper depthing of dart tooth with intermittent wheel teeth:

1. Intermittent lever not turning freely on post in plate.
2. Intermittent lever spring not holding enough tension on intermittent lever.
3. Improperly adjusted eccentric stud could prevent proper depthings of these parts. (See adjustment of eccentric studs.)

REMARKS:

If the depthing of the intermittent wheel teeth with the seconds wheel dart tooth is deep, the minute register wheel may move two teeth each time the seconds wheel makes one revolution.

If the depthing is shallow, it may cause the minute register wheel not to move a full tooth and thus will not register the minutes on the dial.

C. Check to see that seconds hand moves forward in a steady manner with no irregular jumping or jerking.

CORRECTION: The irregular movement of seconds hand is usually caused by too weak a tension of seconds wheel tension spring on seconds wheel.

3. Push button at left of pendant, hold in this position and check the following:

(Do not hold button in longer than 57 seconds as this will cause the watch to stop running.)

(Continued on next page)

FUNCTIONAL RESULTS
(Continued)

A. Check to see that brake lever is in contact with seconds wheel.

CORRECTION: Brake lever not turning freely under head of screw may prevent brake lever from contacting seconds wheel.

B. Check to see that minute register wheel stop lever is engaged with the minute register wheel.

CORRECTION: The following errors could prevent the stop lever from engaging with the minute register wheel:

1. Minute register wheel stop lever not pivoting freely under head of screw.
2. Minute register stop lever spring not holding enough tension on minute register stop lever.

4. Release button at left of pendant and check the following:

A. Check to see that brake lever is disengaged from seconds wheel.

CORRECTION: The brake lever binding and not turning freely under head of screw may prevent this lever from disengaging from seconds wheel.

B. Check to see that minute register stop lever is disengaged from minute register wheel.

CORRECTION: The following errors could prevent stop lever from disengaging from minute register wheel:

1. Catch-up push piece not pivoting freely under head of screw.
2. Catch-up push piece spring not holding enough tension on catch-up push piece.
3. Minute register stop lever not pivoting freely under head of screw.

C. Check to see that the sweep second hand "catches up" the time elapsed while the button was held depressed.

CORRECTION: The following errors could prevent the sweep second hand from "catching up" the time that has elapsed while button was depressed.

1. Not enough tension of the catch-up hairspring on the catch-up wheel.

(Continued on next page)

FUNCTIONAL RESULTS
(Continued)

2. **Excess friction on the following parts:**
Catch-up wheel, intermediary wheel, seconds wheel, intermittent wheel, and minute register wheel.

5. Push button to right of pendant, release it, and check the following:

- A. Check to see that the brake lever is in contact with the seconds wheel.

CORRECTION: The following errors could prevent the brake lever from contacting seconds wheel:

1. Brake lever not pivoting freely under head of screw.
2. Brake lever spring not holding enough tension on brake lever.

6. Pull button to right of pendant out.

- A. Check to see that chronograph mechanism is engaged the same as in step No. 2.

CORRECTION: The following errors could prevent chronograph mechanism from engaging properly.

1. Reversing joint hook not being replaced proper in movement.
2. Reversing joint hook binding and not pivoting freely under head of screw.

DIRECTIONS FOR READING CHRONOGRAPH DIAL

THE TACHOMETER

- A The tachometer is used to indicate the speed of an object in miles per hour. A tachometer can only indicate the average speed of an object traveling over a course of a measured mile.

METHOD OF USING TACHOMETER

1. Start the chronograph sweep second hand at the exact moment the object starts to travel the measured distance of one mile.
2. When the object has traveled the course of one mile, stop the chronograph at the point on the tachometer scale where the sweep second hand stopped. It will indicate the average speed in miles per hour.

SPLIT SECOND SCALE

- B This scale is divided into 300 divisions. Each indicating $\frac{1}{5}$ of a second every fifth division is marked with extra long lines denoting one second.

The main purpose of this scale is to measure a fraction of a second accurately.

SECOND HAND

- C The second hand indicates the passing of seconds and should move one space each second. One complete revolution of hand denotes passage of one minute. This hand is independent of chronograph mechanism and continues to register the seconds as long as watch is running.

TELEMETER

- D The telemeter is used to denote the number of miles between two points. This is done by comparing the speed of light to the speed of sound.

METHOD OF USING TELEMETER

1. Start chronograph sweep second hand when you see lightning.
2. Stop the chronograph sweep second hand when you hear the thunder. The point on the telemeter scale where the sweep second hand stopped will indicate the distance in miles the lightning is away from you.

MINUTE REGISTER

- E The minute register hand indicates the passing of minutes. This hand should move forward one space each minute. One complete revolution of minute register hand indicates passage of 30 minutes. Two revolutions one hour.

THE CHRONOGRAPH DIAL

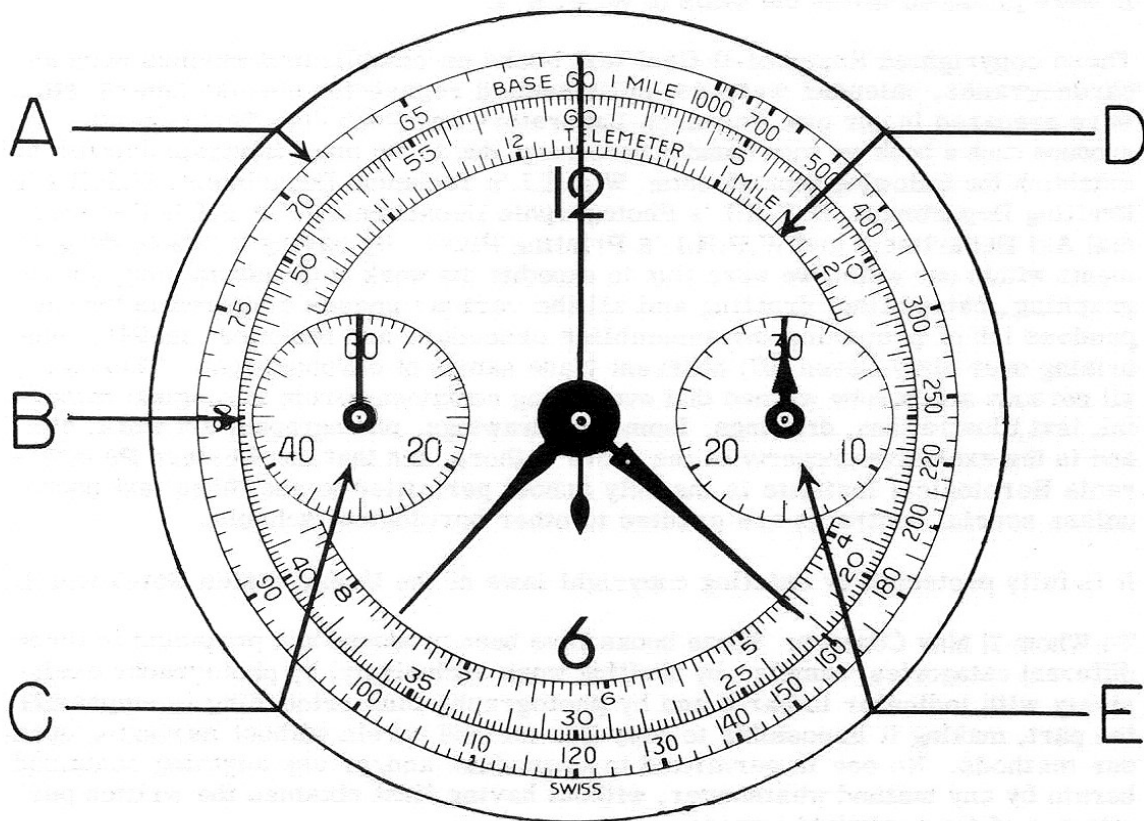

SETTING THE HANDS CORRECTLY ON A CHRONOGRAPH:

After the chronograph is completely assembled and in working condition, place chronograph in its case. Now replace the hands, replace the hour hand, minute hand and second hand as you would on a regular watch. At this point, do not replace the sweep second or the minute register hand. Now push the button and bring the flyback lever in toward the center of the watch. When the flyback lever is held in toward the center of the watch, place the sweep second hand at 60 on split second scale 'B'. Place the minute register hand at 30 on minute register scale 'E'. After these hands are replaced, start chronograph mechanism with sweep second hand turning. Leave chronograph mechanism run for at least one minute, now push the button to bring the flyback lever in toward the center of the watch again, and check to see that the minute register hand and the sweep second hand goes back to their original position.