

**WORLD'S ONLY
FULLY ILLUSTRATED
CHRONOGRAPH WATCH COURSE
VOLUME 13**

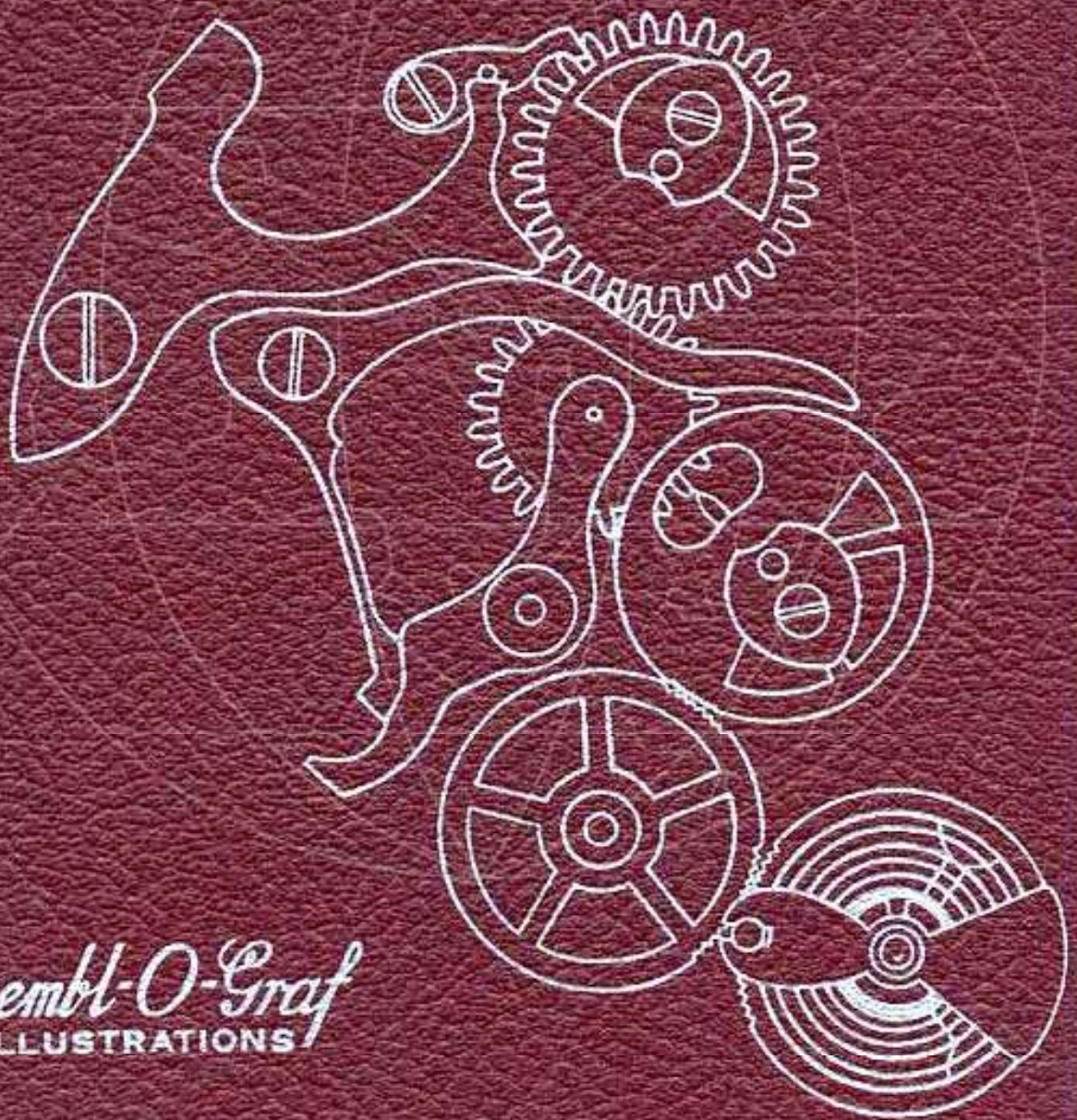

Essembl-O-Graf
ILLUSTRATIONS

IDENTIFICATION OF CHRONOGRAPH

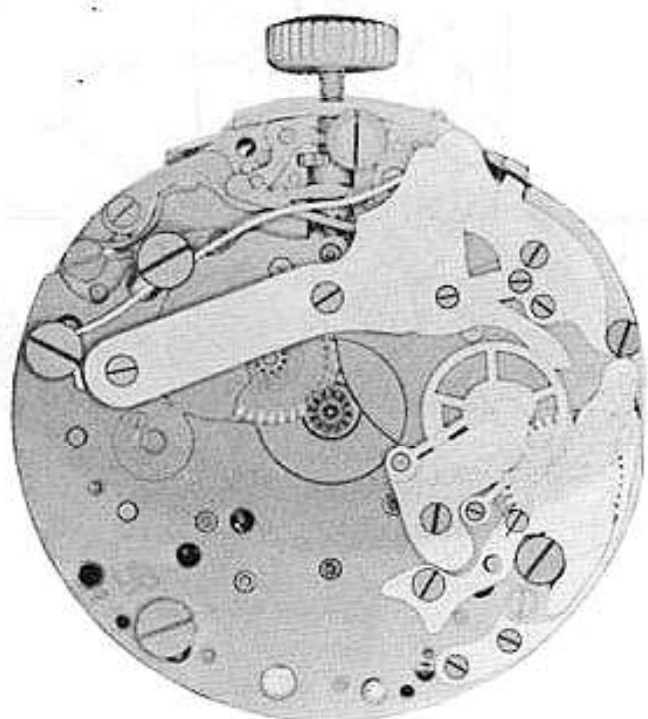

14L



VALJOUX

CAL. 71



ESEMBL-O-GRAF

THE WORLD'S FIRST FULLY
ILLUSTRATED TEXT BOOK
ON
CHRONOGRAPH REPAIRING
AND ADJUSTING

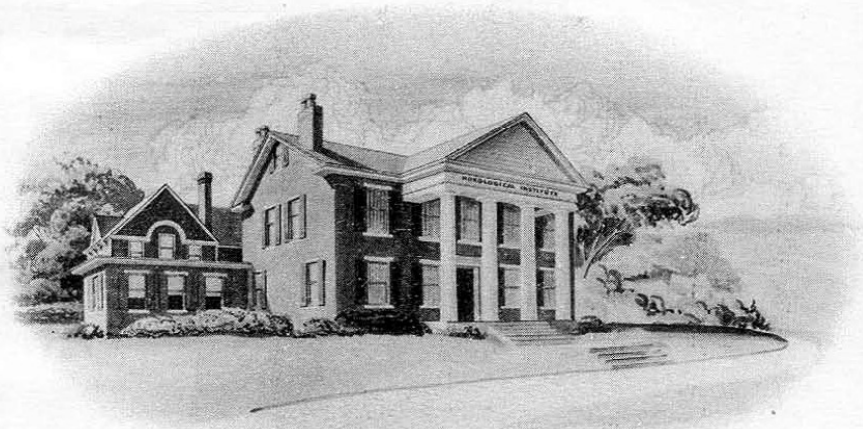

BY
William O. Smith, Sr.
PRESIDENT AND TECHNICAL DIRECTOR
AND
William O. Smith, Jr.
CHIEF ENGINEER, RESEARCH LABORATORIES

WESTERN PENNSYLVANIA HOROLOGICAL INSTITUTE, INC.
PITTSBURGH, PENNSYLVANIA

INSTRUCTIONS

For use of book

DISASSEMBLY OF THE CHRONOGRAPH MECHANISM:

1. Study the isometric drawing at top of page 1-A. The isometric drawing was made for the following purposes:
 - A. It helps to identify the part to be removed.
 - B. This drawing aids in pointing out certain locations on the part that are mentioned in the oiling procedure.
 - C. The text refers to certain points on the part. These points are shown in the isometric drawing. This should aid you in finding the exact location on the part that is described in the text.
 - D. It helps you to know the shape of the part in case a new part has to be made.
2. At the bottom of the page 1-A is a photograph of a chronograph. In this photograph is the same part painted in black. The part is in its exact location that this part occupies in the watch. Find this location in the watch.
3. Read the disassembly procedure and the hazards in disassembly on page 1 in this book.
4. Remove this part in the same procedure as described in the text.
5. A very important item in disassembling a chronograph is keeping the screws in order, much time will be lost in putting the chronograph together if screws are mixed up. This means you have to hunt for each screw, sometimes trying three or four screws before finding the correct one. It cannot be stressed too strongly that care should be taken so that screws are not mixed up. The system that we advise for beginners, is to replace each individual screw after each part is removed. This naturally eliminates the hazard of mixing up the screws and will save you much time in the end. Do this at least until you become so thoroughly familiar with the chronograph that you no longer feel it is necessary.
6. Continue to follow this procedure throughout the book and disassemble each part until the last part of the chronograph is removed.

ASSEMBLY OF THE CHRONOGRAPH MECHANISM:

7. When you are ready to assemble the chronograph mechanism, study the isometric drawing on the last part in this book. This drawing should aid you in identifying the part to be assembled.
8. At the bottom of this page is a photograph of a chronograph. In this photograph is the same part painted in black. The part is in its exact location that this part occupies in the watch.
9. Read the assembly procedure and the hazards in assembling for the last part in this book. (Continued on next page)

INSTRUCTIONS (Continued)

10. Replace the part in its exact location as shown in photograph, using the procedure as described in the text.

11. After you find the correct location for this part in the watch, read the oiling procedure for this part. The oiling procedure for this part is located underneath the isometric drawing. It is best to read the oiling procedure before you put each part in place as there are certain parts that must be oiled immediately as it may prove difficult to oil them later.

12. Replace the screw that holds this part in place. Of course, the screws should be kept in order as we advised above, but if the screws are not in order or the watch was received with screws mixed up, you will find a screw drawn for each part that requires a screw at the bottom of the text page.

13. After replacing this part, replace the next part, etc., until the last part is replaced, which will be part No. 1. Each part should be replaced using the same procedure as described in the text.

(Naturally, the assembly of the chronograph is exactly the reverse of the disassembly)

14. After disassembling and assembling the chronograph mechanism, start on page 1 and read the function of this part. After reading the function of this part, continue to read the function of each part throughout the book. Study each part, one at a time. This text should help you to understand more fully the purpose of each part in the chronograph mechanism.

15. Now put movement in its case with dial on, then replace hands.

16. Study the text on functional results in this book, and check the chronograph mechanism as described in this text.

NOMENCLATURE OF PARTS FOR CHRONOGRAPH MECHANISM







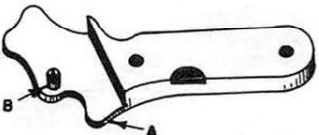

17. After you have become familiar with the chronograph mechanism, you can disassemble and assemble the chronograph by using the nomenclature of parts as a guide. This makes it possible for you to use a procedure without going through each page in the book.

18. ADJUSTMENT OF ECCENTRIC STUDS:

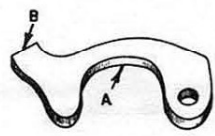
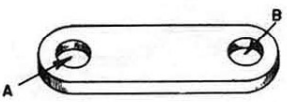
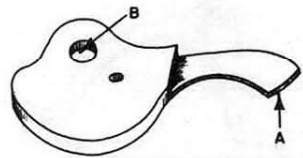
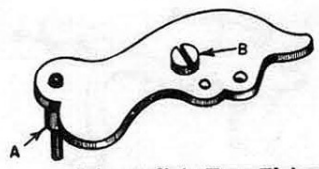
Read the text on adjustment of eccentric studs, this text should be read in reference to the eccentric stud picture. Now adjust each eccentric stud one at a time in the watch, as described in the text. Use the picture to show you the position of these studs.

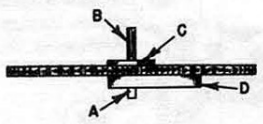
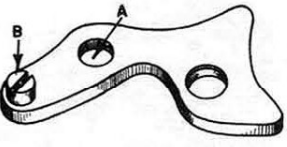
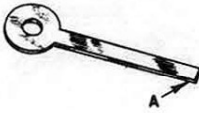
19. On each page in this book the part number and the page number are the same. This makes it convenient for the reader and eliminates any confusion.

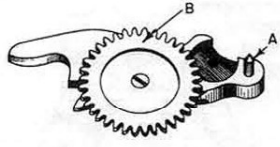
NOMENCLATURE OF PARTS FOR CHRONOGRAPH MECHANISM

 <p>Hour Flyback Lever Bridge Assembly No. 1</p>	 <p>Hour Flyback Spring Assembly No. 2</p>	 <p>Hour Flyback Push Piece Assembly No. 3</p>
 <p>Articulation Arm Assembly No. 4</p>	 <p>Hour Flyback Lever Assembly No. 5</p>	 <p>Intermediate Hour Flyback Detent Assembly No. 6</p>
 <p>Hour Register Wheel Tension Spring Assembly No. 7</p>	 <p>Hour Register Wheel Bridge Assembly No. 8</p>	 <p>Hour Register Wheel Assembly No. 9</p>
 <p>Hour Yoke Connecting Lever Assembly No. 10</p>	 <p>Intermediate Hour Wheel Tension Spring Assembly No. 11</p>	 <p>Intermediate Hour Yoke Spring Assembly No. 12</p>
 <p>Intermediate Hour Yoke and Wheel Assembly No. 13</p>	 <p>Transmission Pinion Assembly No. 14</p>	

Continued on next page

NOMENCLATURE OF PARTS FOR CHRONOGRAPH MECHANISM



Wheel Over Fourth Wheel
Assembly No. 15



Minute Register Pawl
Assembly No. 16



Flyback Lever Spring
Assembly No. 17

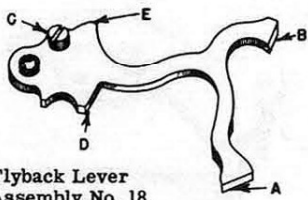

Flyback Lever
Assembly No. 18

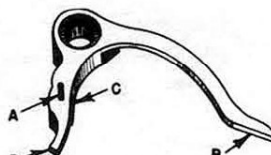

Brake Lever
Assembly No. 19

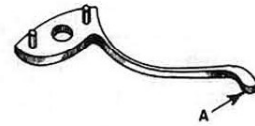

Brake Lever Spring
Assembly No. 20

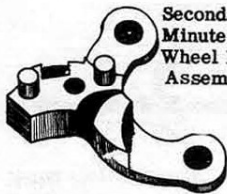

Seconds Wheel &
Minute Register
Wheel Bridge
Assembly No. 21

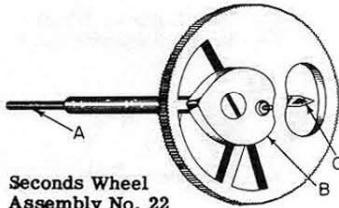

Seconds Wheel
Assembly No. 22



Seconds Wheel Tension Spring
Assembly No. 23

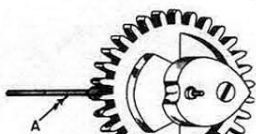

Minute Register Wheel
Assembly No. 24

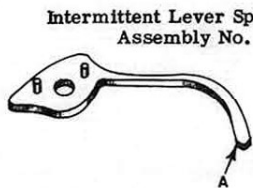

Intermittent Lever Spring
Assembly No. 25

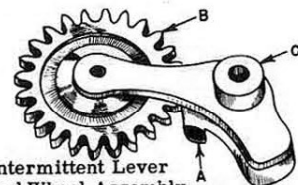

Intermittent Lever
and Wheel Assembly
Assembly No. 26



Chronograph Pivoted Detent
Spring Assembly No. 27

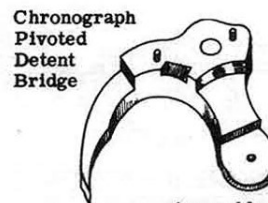

Assembly No 28

Continued on next page

NOMENCLATURE OF PARTS FOR CHRONOGRAPH MECHANISM

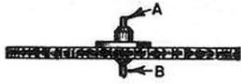

Intermediary Wheel
Assembly No. 29

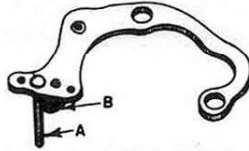

Chronograph Pivoted Detent
Assembly No. 30

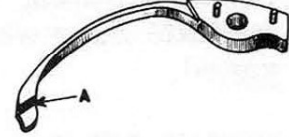

Actuating Detent Lever
Spring Assembly No. 31

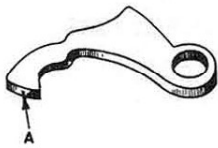

Joint Hook
Assembly No. 32

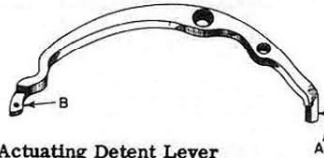

Actuating Detent Lever
Assembly No. 33

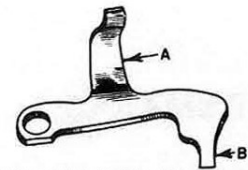

Push Piece for Setting Back
to Zero Assembly No. 34



Castle Wheel Pawl
Assembly No. 35

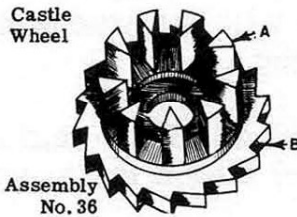

Castle
Wheel
Assembly
No. 36



Sweep Second Hand



Minute Register Hand



Hour Register Hand



Chronograph
Button



Chronograph
Button

ADJUSTMENT OF ECCENTRIC STUDS ON DIAL SIDE

Listed below are a number of depthings and adjustments controlled by the eccentric studs:

1. Check depthing of hour register wheel teeth, with the intermediate hour wheel pinion teeth, when these wheels are engaged.

CORRECTION: If this depthing is incorrect, it can be corrected by adjusting eccentric stud ES-1.

REFERENCE: Hour register wheel is Assembly 9.
The intermediate hour wheel pinion is on the intermediate hour wheel, Assembly 13-B.

REMARKS:

When the hour register wheel teeth are engaged with the intermediate hour wheel pinion teeth, check to see that there is clearance between eccentric stud ES-2 and intermediate hour yoke. There should be just enough clearance so that you can be sure that at no time will the stud and yoke touch when these wheels are engaged.

2. Check the clearance between hour register wheel teeth and the intermediate hour wheel pinion teeth, when they are disengaged.

CORRECTION: If this clearance is incorrect, it can be corrected by adjusting eccentric stud ES-2.

REFERENCE: Hour register wheel is Assembly 9.
Intermediate hour wheel pinion is Assembly 13-B.

3. Check to see that seconds wheel (on train side) and hour register wheel (on dial side) return to a zero position when the push piece for setting back to zero is pushed.

CORRECTION: If one of these wheels does not return to a zero position when push piece is pushed, this condition can be corrected by adjusting eccentric stud ES-3.

REFERENCE: Hour register wheel is Assembly 9.
Seconds wheel is Assembly 22.

ADJUSTING ECCENTRIC STUDS

DO NOT REMOVE THESE STUDS
DIAL SIDE

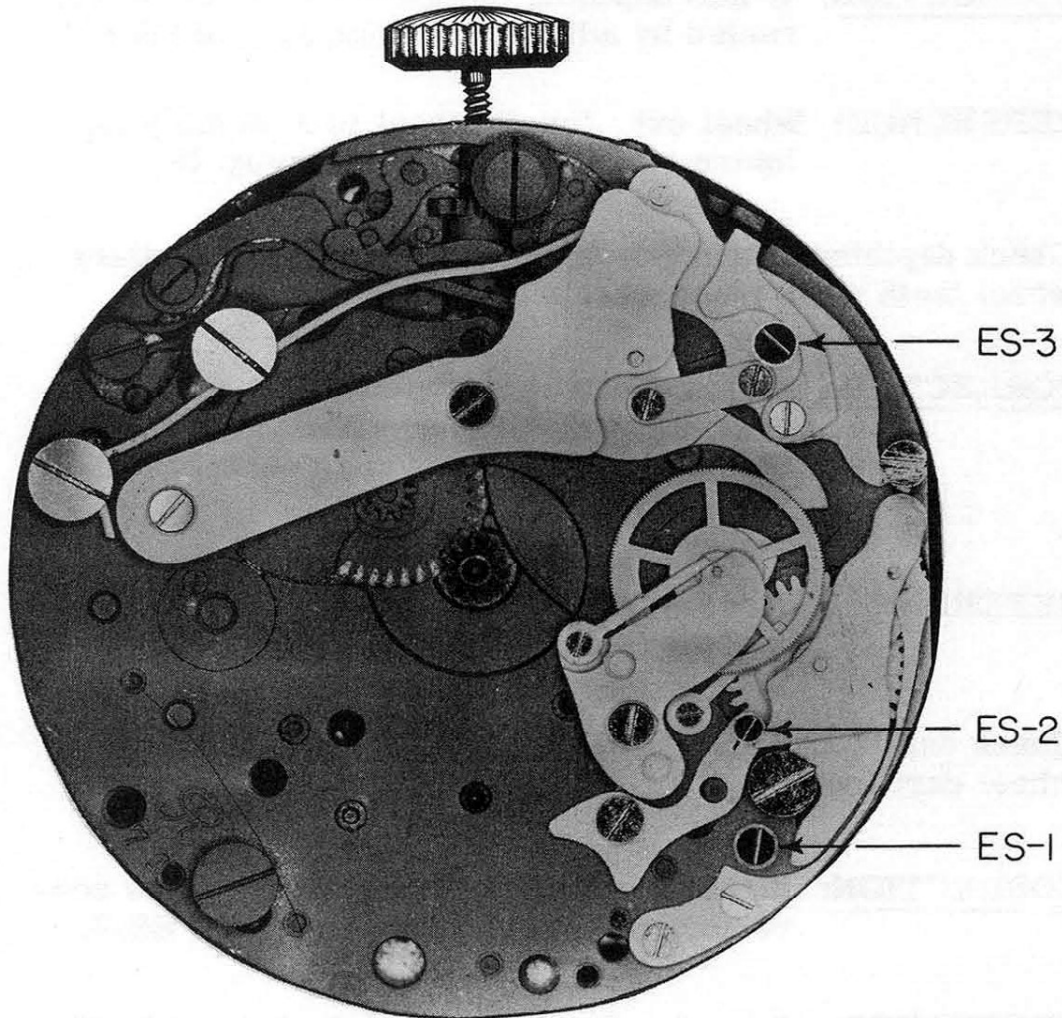

CAUTION

In disassembling or assembling chronograph it is a good policy not to turn eccentric studs. These eccentric studs are used to adjust one part to another, and naturally, in turning these studs you will lose the desired adjustment of the chronograph mechanism, which will cause the chronograph to function incorrectly. Another reason for not turning these studs, unless it is necessary, is, that they soon become loose and will not hold the desired adjustment.

ADJUSTMENT OF ECCENTRIC STUDS ON TRAIN SIDE

Listed below are a number of depthings and adjustments controlled by the eccentric studs:

1. Check depthing of wheel over fourth wheel teeth with the intermediary wheel teeth.

CORRECTION: If this depthing is incorrect, it can be corrected by adjusting eccentric stud ES-4.

REFERENCE: Wheel over fourth wheel is Assembly 15.
Intermediary wheel is Assembly 29.

2. Check depthing of seconds wheel teeth with intermediary wheel teeth when these wheels are engaged.

CORRECTION: If this depthing is incorrect, it can be corrected by adjusting eccentric stud ES-5.
Sometimes it may also be necessary to adjust eccentric stud ES-4.

REFERENCE: Seconds wheel is Assembly 22.
Intermediary wheel is Assembly 29.

3. Check depthing of intermittent wheel teeth with seconds wheel dart tooth.

CORRECTION: If this depthing is incorrect, it can be corrected by adjusting eccentric stud ES-6.

REFERENCE: Seconds wheel dart tooth is Assembly 22-C.
Intermittent wheel is Assembly 26-B.

ADJUSTING ECCENTRIC STUDS

DO NOT REMOVE THESE STUDS
TRAIN SIDE

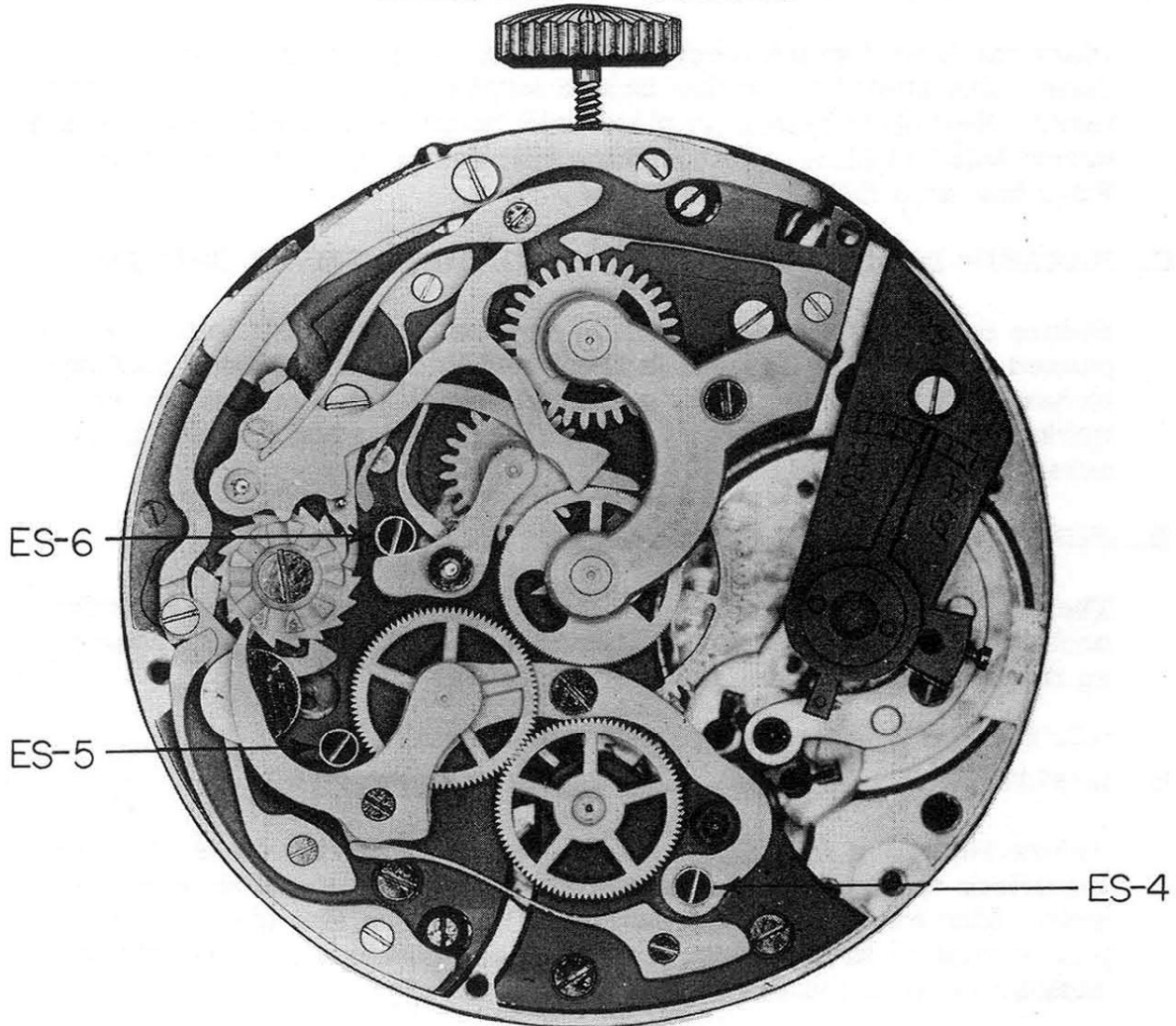

CAUTION

In disassembling or assembling chronograph it is a good policy not to turn eccentric studs. These eccentric studs are used to adjust one part to another, and naturally, in turning these studs you will lose the desired adjustment of the chronograph mechanism, which will cause the chronograph to function incorrectly. Another reason for not turning these studs, unless it is necessary, is, that they soon become loose and will not hold the desired adjustment.

A. DISASSEMBLY PROCEDURE OF HOUR FLYBACK LEVER BRIDGE:

This bridge is held in place by identical fillister head screws, FS-1 and FS-2. Remove these screws, grip bridge at location "A" with a pair of tweezers, and lift straight up on bridge.

(The shape of screws for this part is shown at bottom of page.)

B. ASSEMBLY PROCEDURE OF HOUR FLYBACK LEVER BRIDGE:

Place the hour flyback lever bridge in its proper position on the plate. The stud "B" on this bridge must fit into the hole in flyback lever. Now slide bridge on plate until holes in bridge fit over proper screw holes in plate. Now replace fillister head screws FS-1 and FS-2 that hold this bridge in place.

C. HAZARDS IN ASSEMBLY OF HOUR FLYBACK LEVER BRIDGE:

Before replacing screws, check to see that screw "B" in bridge has passed through hole in flyback lever and into hole in plate. Failure to have this screw in proper place, will cause this mechanism not to work properly, or may result in bending bridge, when fillister head screws are replaced.

D. FUNCTION OF HOUR FLYBACK LEVER BRIDGE:

The function of the hour flyback lever bridge is to hold the hour flyback lever and the connecting flyback mechanism in proper position so that they can function properly.

REFERENCE: Hour flyback lever is Assembly 5.

E. REMARKS:

Before replacing hour flyback lever bridge, examine the surface of the bridge that covers the hour flyback lever for any pits or roughness. Also examine the screw head "B" to see that there are no pits of rust on it. Any roughness at these points may cause the flyback lever to bind and not pivot freely.

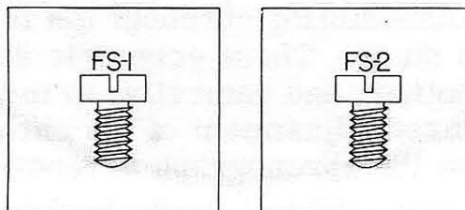

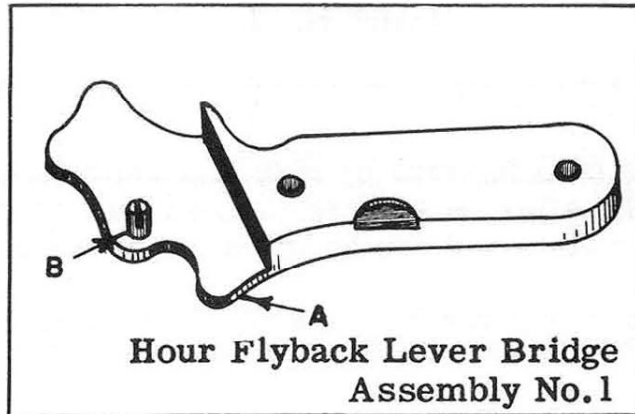

OILING

Screw-head "B" on hour flyback lever bridge on which the hour flyback lever pivots should be slightly moistened with oil.

DIAL SIDE

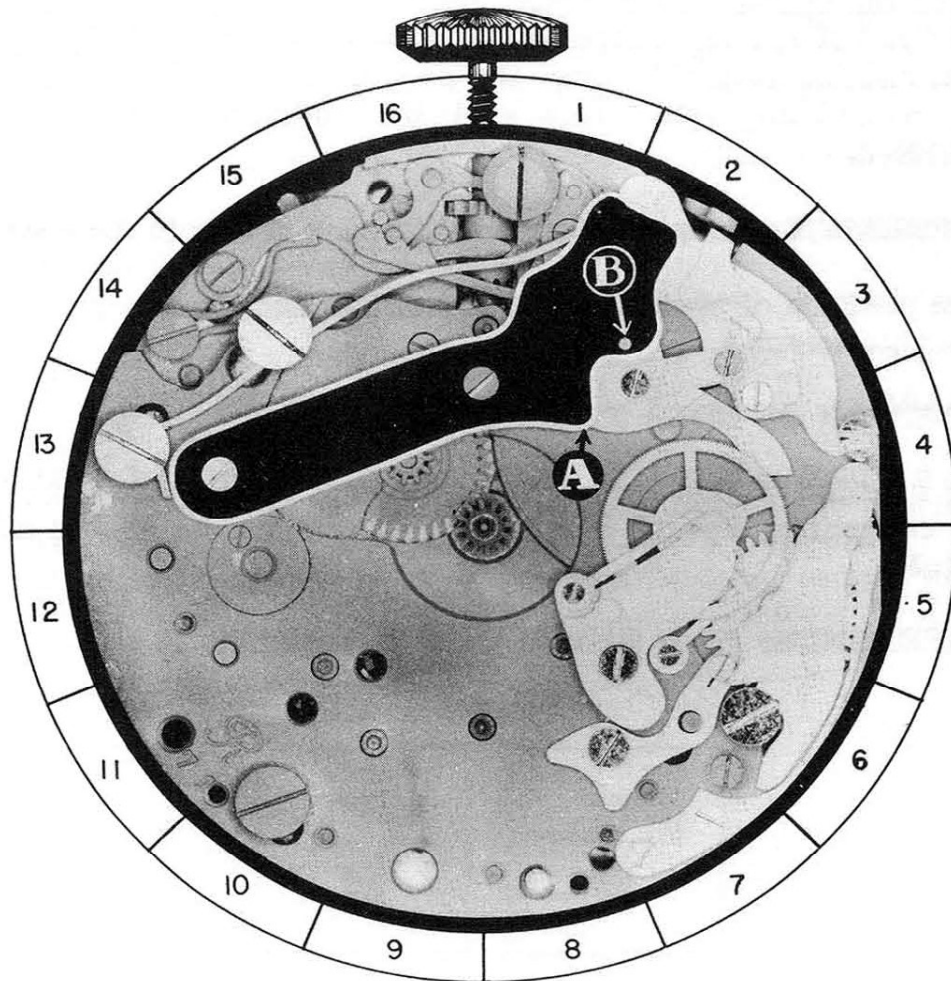

1-A

DIAL SIDE

PART NO. 2

A. DISASSEMBLY PROCEDURE OF HOUR FLYBACK SPRING:

This spring is held in place by identical shouldered screws, SS-1 and SS-2. After these screws are removed, the spring will be free on plate and can be lifted out of place.

(The position of screws SS-1 and SS-2 is shown in the photograph.)

(The shape of screws for this part is shown at bottom of page.)

B. HAZARDS IN DISASSEMBLY OF HOUR FLYBACK SPRING:

Hold finger over spring when removing screw so that the screw cannot possibly shoot away and be lost.

C. ASSEMBLY PROCEDURE OF HOUR FLYBACK SPRING:

Place the spring in its proper position on the plate, with the end "A" of spring contacting the intermediate hour flyback detent, and the loop "B" over the proper screw hole in plate, as shown in photograph. Now replace shouldered screws, SS-1 and SS-2.

REFERENCE: Intermediate hour flyback detent is Assembly 6.

(The position of shouldered screws SS-1 and SS-2 is shown in the photograph.)

D. FUNCTION OF HOUR FLYBACK SPRING:

The function of this spring is to force the hour flyback lever and the connecting flyback mechanism away from the center of the watch.

REFERENCE: Hour flyback lever is Assembly 5.

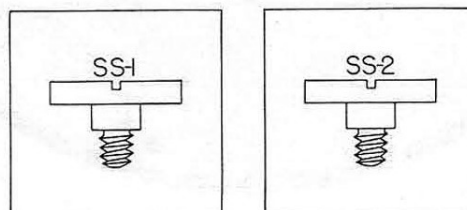

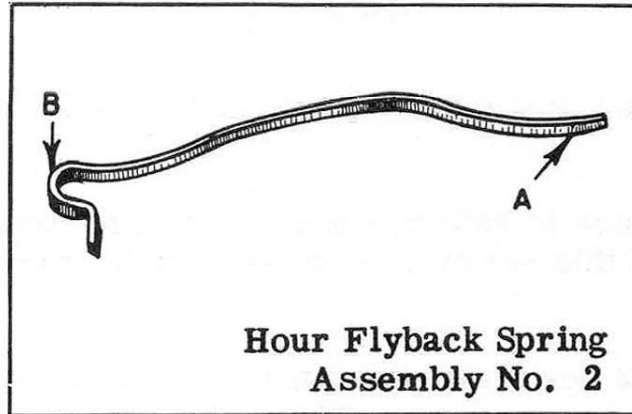

OILING

End "A" of hour flyback lever spring should be slightly moistened with oil at point of contact with intermediate hour flyback detent.

DIAL SIDE

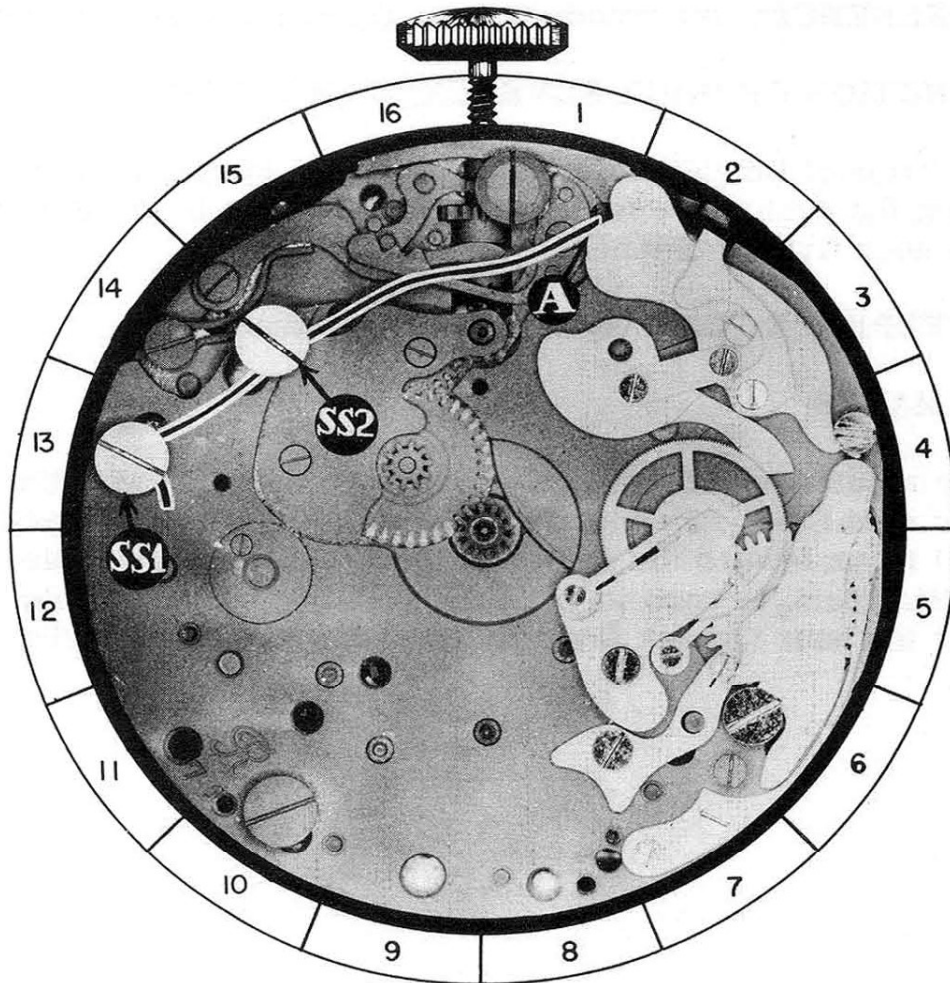

2-A

A. DISASSEMBLY PROCEDURE OF HOUR FLYBACK PUSH PIECE:

This push piece is held in place by beveled countersink screw BS-1. When this screw is removed, push piece may be lifted out of place.

(The shape of screw for this part is shown at bottom of page.)

B. ASSEMBLY PROCEDURE OF HOUR FLYBACK PUSH PIECE:

Place the push piece in position on the intermediate hour flyback detent. The surface "A" of push piece should contact the eccentric stud ES-3, at point "A", as shown in the photograph. Now replace beveled countersink screw BS-1 to hold push piece in place.

REFERENCE: Intermediate hour flyback detent is Assembly 6.

C. FUNCTION OF HOUR FLYBACK PUSH PIECE:

Function of this adjustable push piece is to transmit the power from the push piece for setting back to zero to the intermediate hour flyback detent.

REFERENCE: Hour flyback lever is Assembly 5.

REMARKS:

The adjustment of this push piece in connection with the eccentric stud ES-3, determines the distance the hour flyback lever will move toward the center of the watch when push piece for setting back to zero is pushed. This makes it possible to adjust the hour flyback lever in accordance with the flyback lever.

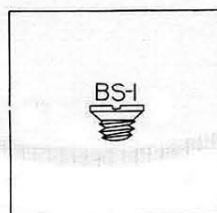

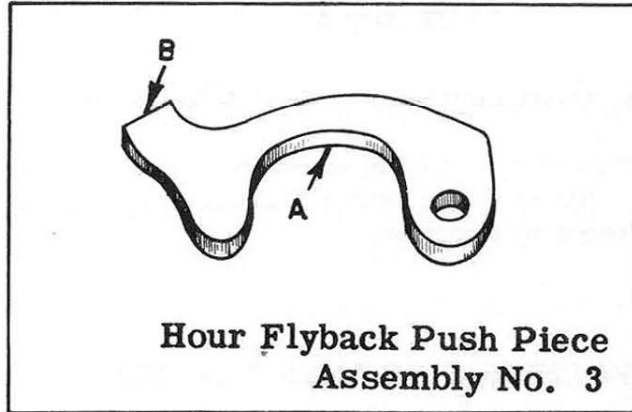

OILING

End "B" on hour flyback push piece should be slightly moistened with oil at point of contact with push piece for setting back to zero.

DIAL SIDE

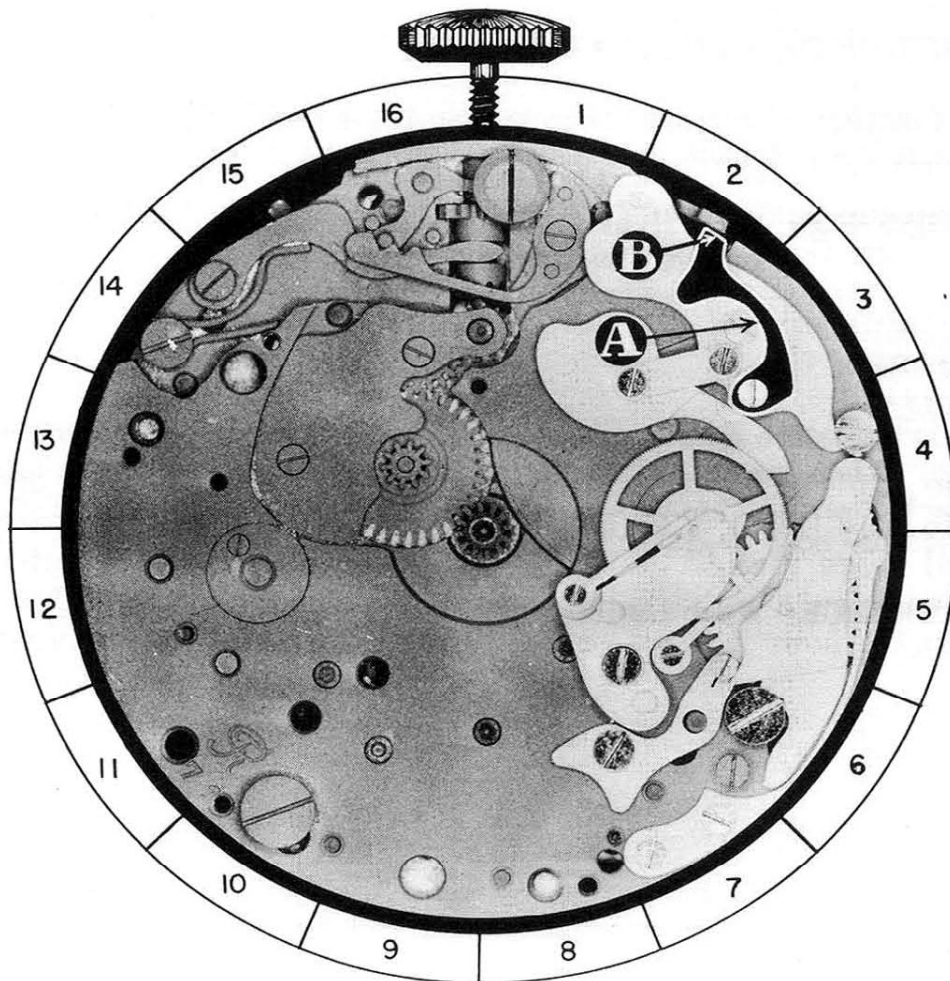

3-A

A. DISASSEMBLY PROCEDURE OF ARTICULATION ARM:

The articulation arm is held in place by identical shouldered screws SS-3 and SS-4. After these screws are removed, the articulation arm can be lifted out of place.

(The shape of screws for this part is shown at bottom of page.)

B. ASSEMBLY PROCEDURE OF ARTICULATION ARM:

Place hole "A" in articulation arm over hole in intermediate hour flyback detent and replace shouldered screw. Now place hole "B" in articulation arm over screw hole in hour flyback lever, and replace shouldered screw to hold articulation arm in place. After articulation arm is replaced, then see that it moves freely on intermediate hour flyback detent. Also check to see that the hour flyback lever moves freely under articulation arm. This articulation arm must move freely on the hour flyback lever and the intermediate flyback detent.

C. FUNCTION OF ARTICULATION ARM:

The function of this arm is to transmit the power from the intermediate hour flyback detent to the hour flyback lever.

REFERENCE: Hour flyback lever is Assembly 5.
Intermediate hour flyback detent is Assembly 6.

REMARKS:

The articulation arm controls the movement of the hour flyback lever. When the articulation arm is forced in, it forces the hour flyback lever to contact the heart on hour register wheel. This causes the hour register wheel to return to a zero position.

REFERENCE: Hour register wheel is Assembly 9.

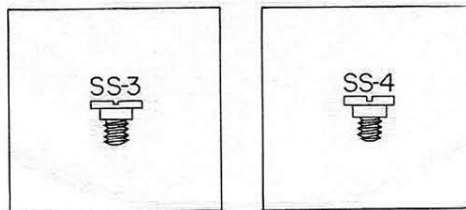

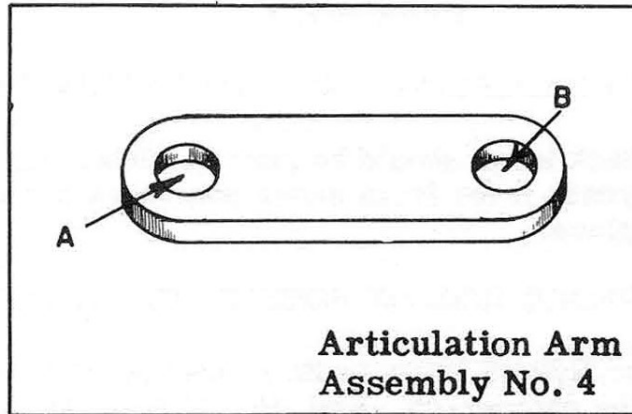

OILING

These points on articulation arm should be slightly moistened with oil.

1. Shoulder of screw which holds this part to hour flyback.
2. Shoulder of screw which holds this part to intermediate hour flyback detent.

DIAL SIDE

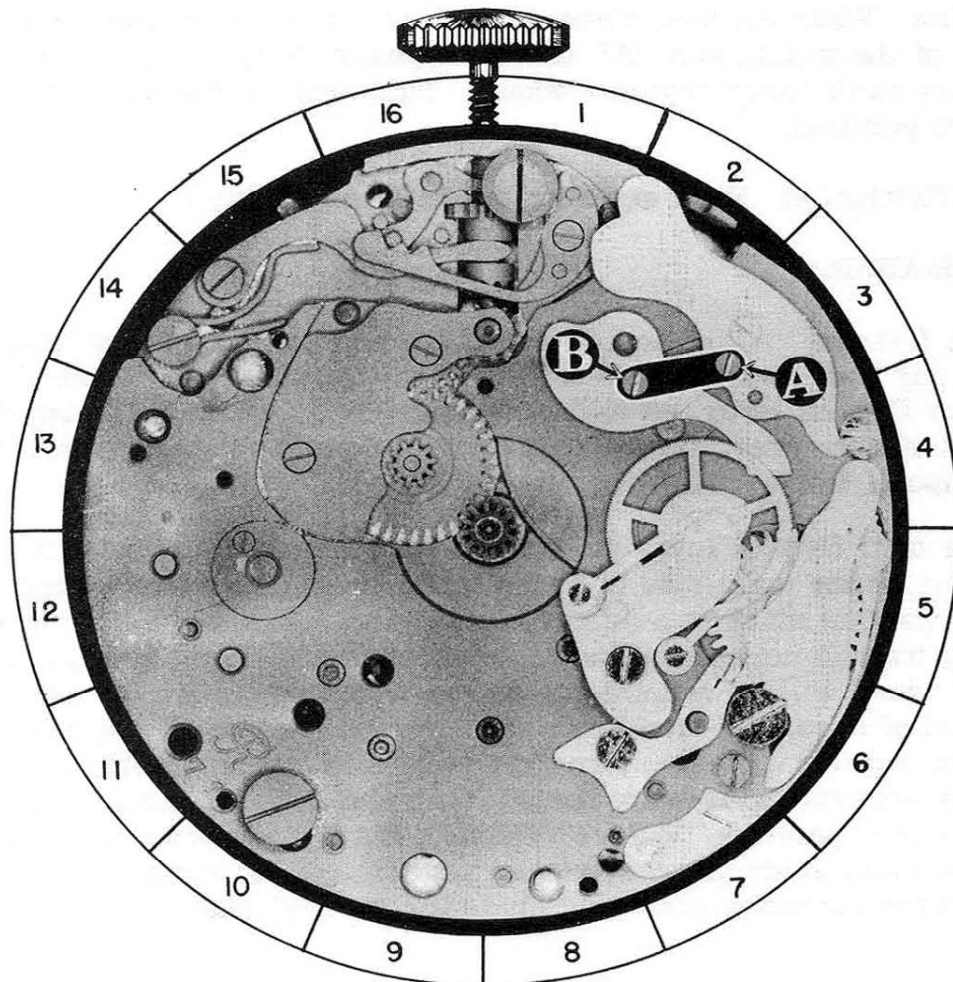

4-A

A. DISASSEMBLY PROCEDURE OF HOUR FLYBACK LEVER:

The hour flyback lever should be free on plate. To remove it, slide hour flyback lever from under hour register wheel, and lift it out of place.

B. ASSEMBLY PROCEDURE OF HOUR FLYBACK LEVER:

Place the hour flyback lever in its proper position on the plate, as shown in the photograph. End "A" of hour flyback lever should be placed under the hour register wheel. Also make sure that the hole "B" in hour flyback lever is over hole in plate when replacing it. The next part to be replaced will hold this part in place.

C. FUNCTION OF HOUR FLYBACK LEVER:

The function of the hour flyback lever is to return the hour register wheel and the hand connected to this wheel to a zero position. When the hour flyback lever is forced in toward the center of the watch, end "A" of hour flyback lever contacts the heart on the hour register wheel. This returns the wheel to a zero position.

REFERENCE: Hour register wheel is Assembly 9.

REMARKS:

The flat end "A" of hour flyback lever must be highly polished, as any roughness or pits of rust at this location may cause the hour flyback lever not to function properly. When polishing the end of this lever, care should be taken so as not to change the shape of this end of lever.

The hour flyback lever must work in unison with the flyback lever on the train side of the chronograph. The chronograph mechanism must be adjusted, so when the push piece, for setting back to zero, is pushed, the seconds wheel and hour register wheel will be returned to a zero position. Improper adjustment of eccentric stud ES-3 may prevent the hour flyback lever from returning the hour register wheel to a zero position, or it may prevent the flyback lever from returning the seconds wheel to a zero position. Before adjusting the flyback lever to work in unison, study the remarks on page 3, and paragraph 3 in the text for adjusting eccentric studs for the dial side.

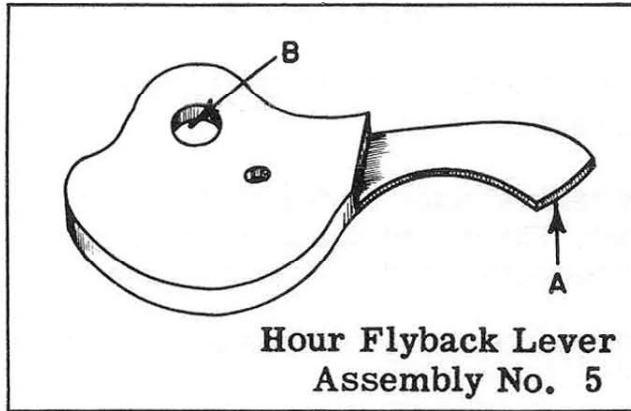

OILING

The hour flyback lever should not be oiled.

DIAL SIDE

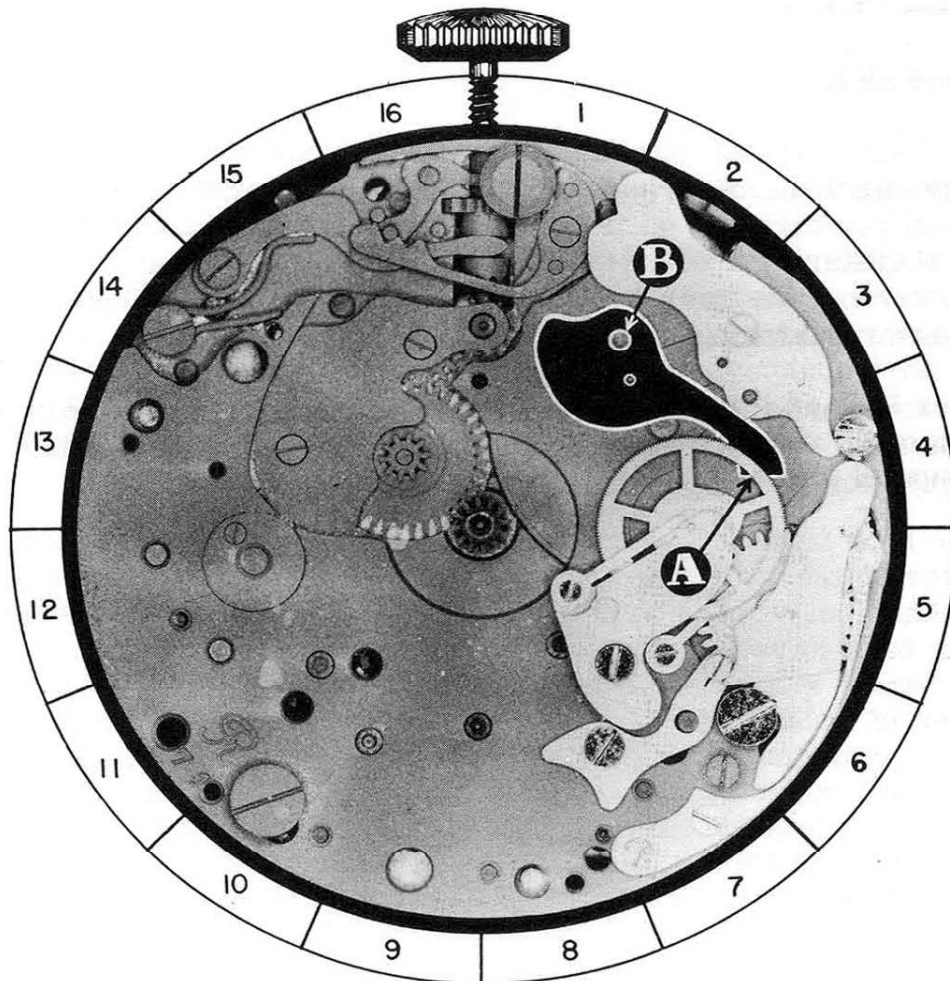

5-A

A. DISASSEMBLY PROCEDURE OF INTERMEDIATE HOUR FLYBACK DETENT:

This detent is held in place by the stud "A" shown in the isometric drawing. The detent should be removed by lifting it straight up, freeing the stud "A" from plate.

B. ASSEMBLY PROCEDURE OF INTERMEDIATE HOUR FLYBACK DETENT:

Place the detent on the plate, in the position shown in the photograph, with the stud "A" down in proper hole in plate. The detent should pivot freely on this stud.

C. FUNCTION OF INTERMEDIATE HOUR FLYBACK DETENT:

The function of this detent isto transmit the power from the hour flyback push piece and the hour flyback spring to the articulation arm.

REMARKS:

The hour register mechanism works in unison with the chronograph mechanism. When the chronograph mechanism is engaged and registering, so is the hour register mechanism engaged and registering. When the chronograph is disengaged and not registering, the hour register mechanism must be disengaged and not registering.

In other words, the hour register mechanism is not always registering. It only registers the hours that the chronograph mechanism is in operation.

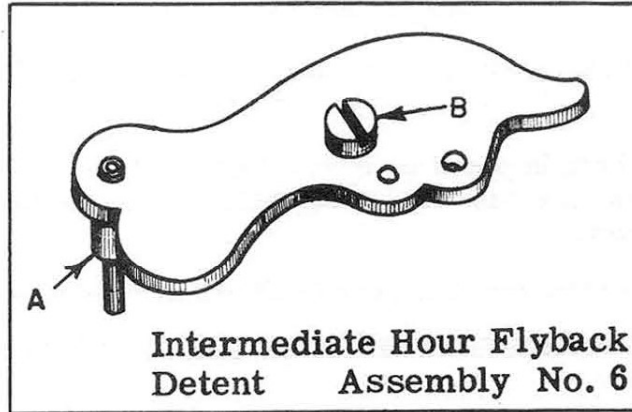

OILING

End "A" of long post on intermediate hour flyback detent should be slightly moistened with oil before placing this part in watch.

DIAL SIDE

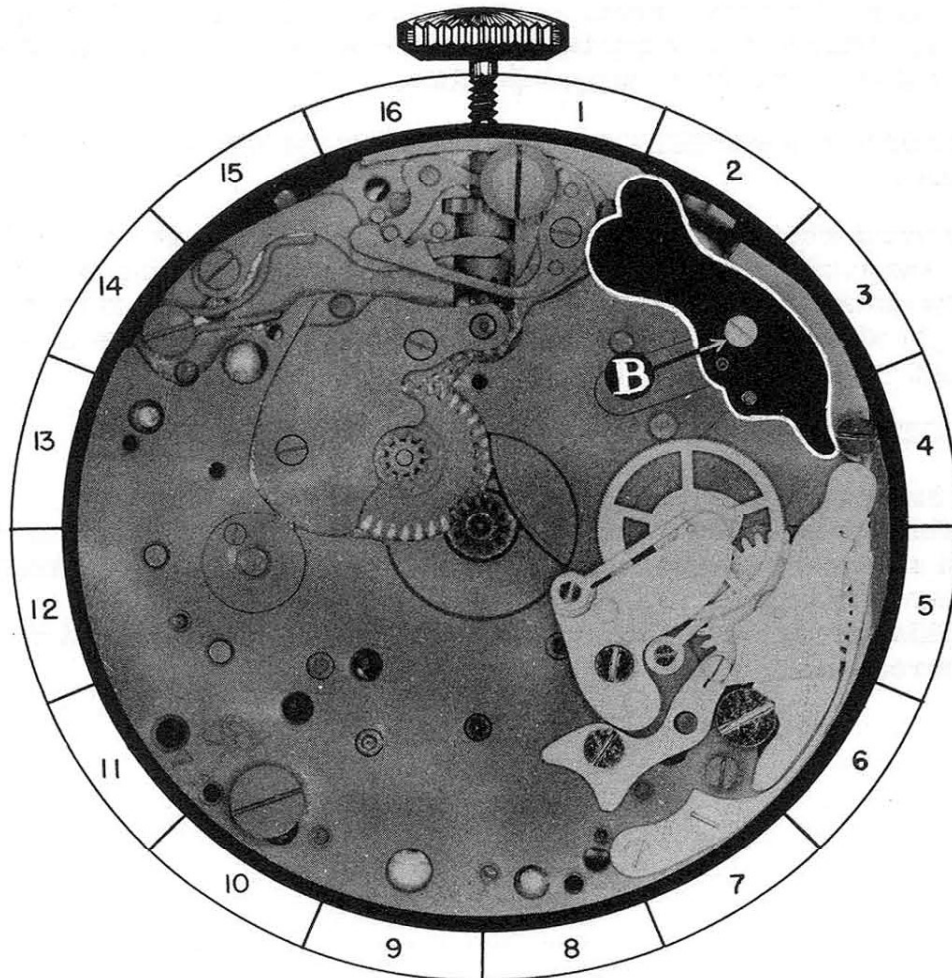

6-A

A. DISASSEMBLY PROCEDURE OF HOUR REGISTER WHEEL TENSION SPRING:

This spring is held in place by beveled countersink screw BS-2. When this screw is removed, spring will be free on plate, and can be lifted out of place.

(The shape of screw for this part is shown at bottom of page.)

B. HAZARDS IN DISASSEMBLY OF HOUR REGISTER WHEEL TENSION SPRING:

This spring is very delicate and easily damaged by a slight slip of the screw-driver when loosening this screw. Care must be taken in removing this part.

C. ASSEMBLY PROCEDURE OF HOUR REGISTER WHEEL TENSION SPRING:

Place spring in its proper position on plate, with hole in spring over proper hole in bridge. Now replace beveled countersink screw BS-2, but before tightening screw, place end "A" of spring on surface "C" on hour register wheel, as shown in the photograph. Now tighten screw. After screw is tightened, check end "A" of spring again to see that it is still in its proper position.

D. HAZARDS IN ASSEMBLY OF HOUR REGISTER WHEEL TENSION SPRING:

Be careful when replacing this spring, as this spring is very delicate and easily damaged. When replacing screw in spring, select a screw-driver of proper size and one that is sharpened correctly, as a slight slip of the screw-driver on this screw may damage this spring.

E. FUNCTION OF HOUR REGISTER WHEEL TENSION SPRING:

The function of this spring is to do two things:

1. This spring holds a tension on hour register wheel to hold it in a stationary position when it is disengaged from the hour register mechanism.
2. This spring holds a tension on hour register wheel so that it turns smoothly with no jumping or jerking.

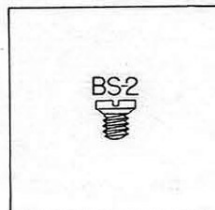

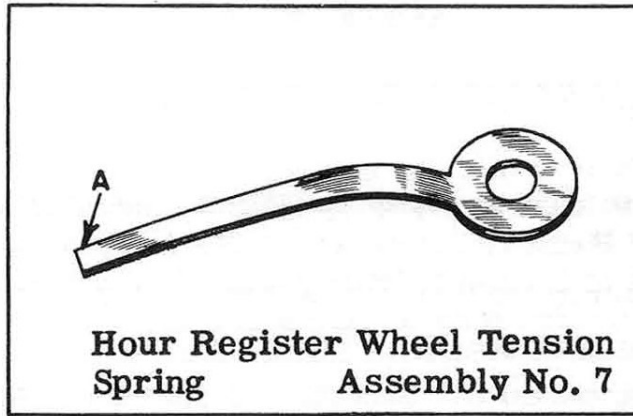

OILING

The hour register wheel tension spring should not be oiled.

DIAL SIDE

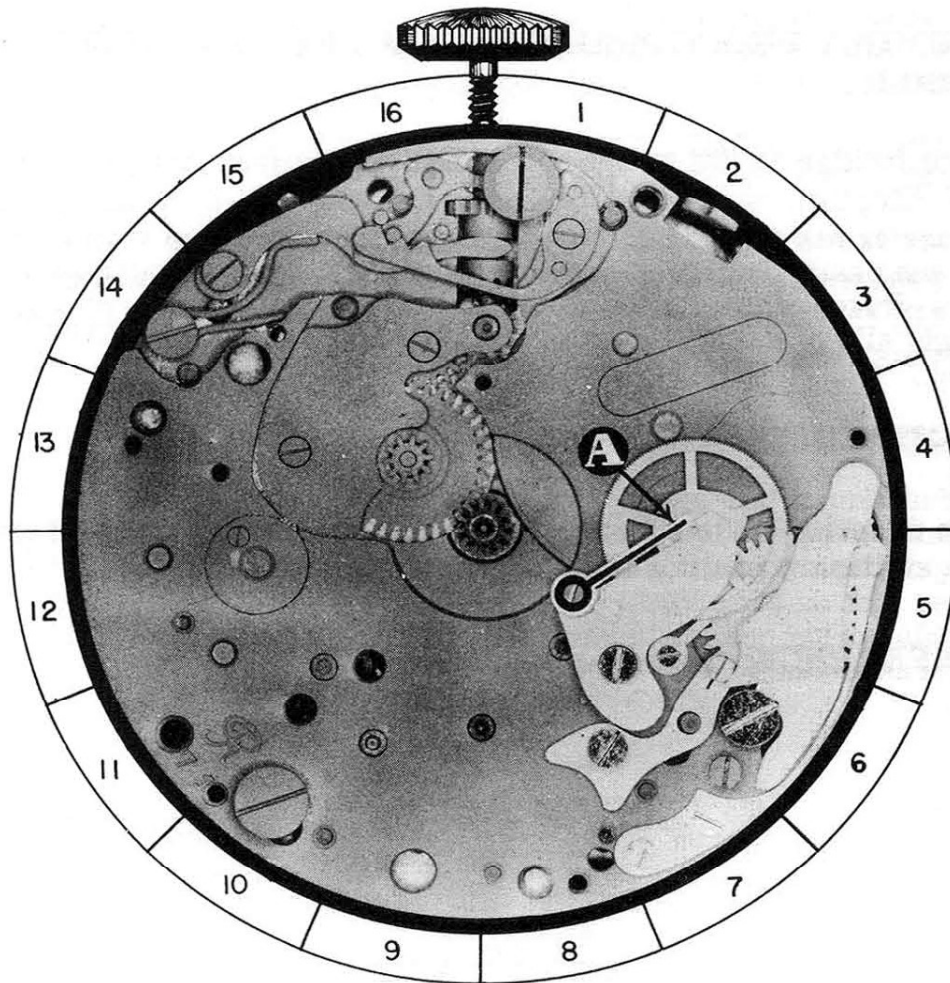

7-A

A. DISASSEMBLY PROCEDURE OF HOUR REGISTER WHEEL BRIDGE:

This bridge is held in place by fillister head screw FS-3 and steady pins. Remove screw, and slide a thin blade screw-driver under bridge to loosen it from plate. When steady pins are free in plate, the bridge may be lifted out of place.

(The shape of screw for this part is shown at bottom of page.)

B. HAZARDS IN DISASSEMBLY OF HOUR REGISTER WHEEL BRIDGE:

When removing this bridge, lift straight up on bridge, freeing it from the pivot on the hour register wheel. Any tilting of this bridge can damage pivots on the hour register wheel. Also be careful not to mar the plate or bridge with screw-driver, when loosening bridge from plate.

C. ASSEMBLY PROCEDURE OF HOUR REGISTER WHEEL BRIDGE:

Place bridge in its proper position with pivot hole in bridge over pivot on hour register wheel. Now place steady pins in proper holes in plate. Press the bridge down to proper place and replace fillister head screw FS-3. After this bridge is replaced, the hour register wheel should be checked to see that it pivots freely and that it has proper endshake.

D. FUNCTION OF HOUR REGISTER WHEEL BRIDGE:

The function of this bridge is to hold the hour register wheel in position so this wheel can function properly.

REFERENCE: Hour register wheel is Assembly 9.

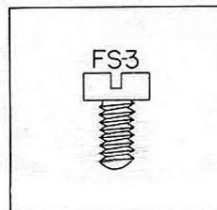

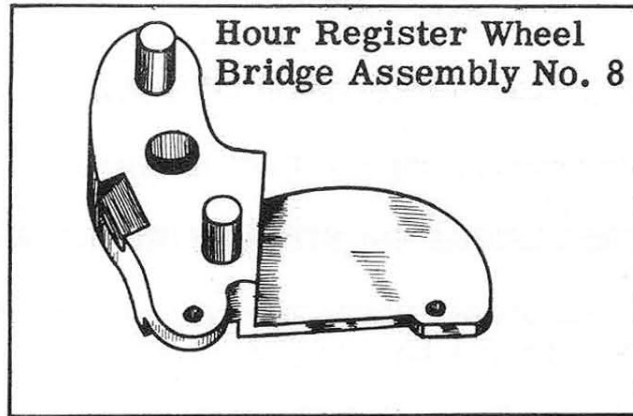

OILING

The pivot in pivot hole in hour register wheel bridge should be slightly moistened with oil.

DIAL SIDE

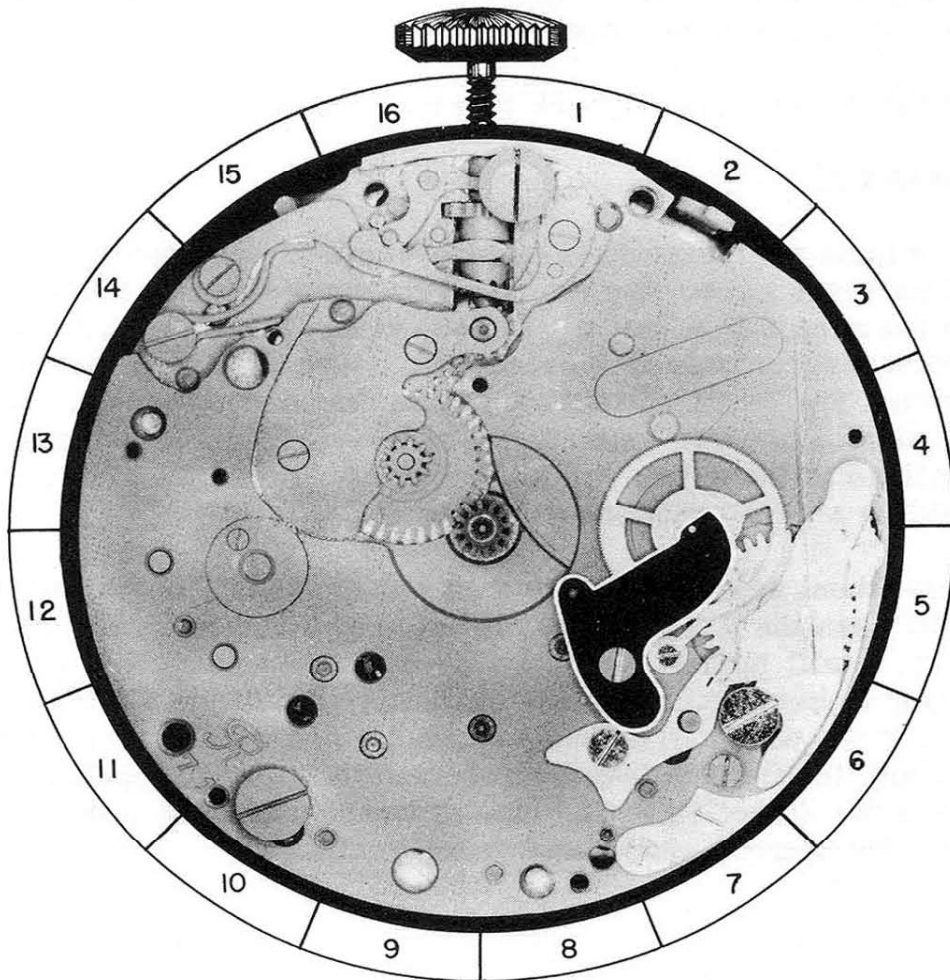

8-A

A. DISASSEMBLY PROCEDURE OF HOUR REGISTER WHEEL:

To remove this wheel, simply lift out of place.

B. ASSEMBLY PROCEDURE OF HOUR REGISTER WHEEL:

Place wheel in its proper position on the plate, with pivot "A" on wheel down in proper hole in plate.

C. FUNCTION OF HOUR REGISTER WHEEL:

The functions of this wheel are:

1. It registers the hours that have elapsed since the beginning of the registration.
2. It returns the hour register hand to zero. This is done by the hour flyback lever contacting the heart "D" on the hour register wheel, forcing the wheel and the hand connected to the wheel to a zero position.

REFERENCE: Hour flyback lever is Assembly 5.

REMARKS:

The minute register wheel is returned to a zero position by the flyback lever contacting the heart on minute register wheel. The heart on this wheel is set eccentric. When the flat end of flyback lever contacts the eccentric heart, it forces the heart to turn. The heart will turn until the flat end of flyback lever sets across the two lobes at top of heart. With the pressure equalized at these two points, it will turn no further, and this would be a zero position.

If this wheel has turned less than 195 degrees from a zero position when the flyback lever is brought in contact with the heart, it will turn in the opposite direction to which it was turning to bring this wheel back to zero position. On the other hand, if the wheel is turned passed 195 degrees from a zero position, the flyback lever will force the heart to continue to turn in the direction it was turning until it reaches a zero position. The degree used above is approximate.

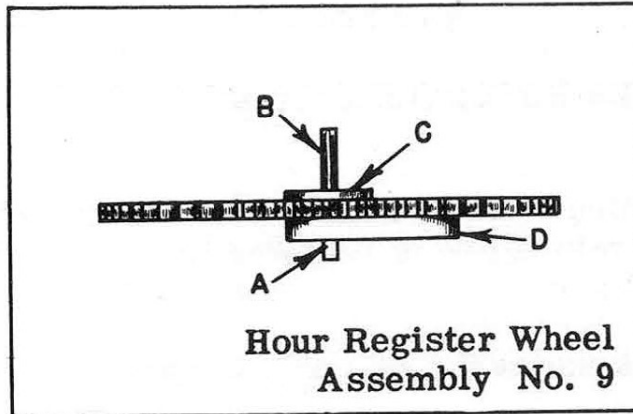

OILING

The bottom pivot on hour register wheel should be oiled before replacing this wheel in watch.

DIAL SIDE

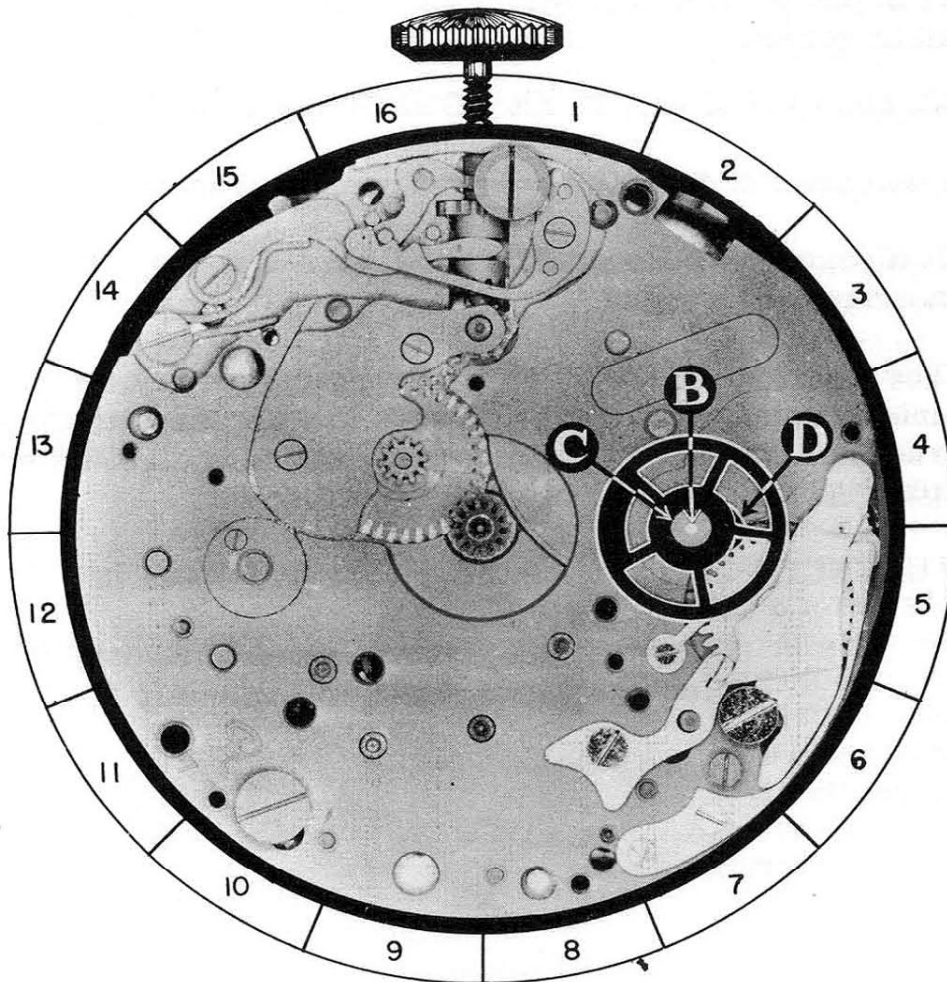

9-A

A. DISASSEMBLY PROCEDURE OF HOUR YOKE CONNECTING LEVER:

This connecting lever is held in place by shouldered screw SS-6. After this screw is removed, the hour yoke can be lifted straight up, free from post and lifted out of place.

(The shape of screw for this part is shown at bottom of page.)

B. ASSEMBLY PROCEDURE OF HOUR YOKE CONNECTING LEVER:

Place the hour yoke connecting lever on the plate, in the position shown in the photograph. The stud "B" on the lever should be up, and the hole "A" should be over the post "A" of the chronograph pivoted detent, which extends above the plate. Now replace shouldered screw SS-6 that holds this part in place. Check lever to see that it pivots freely under head of screw.

C. FUNCTION OF HOUR YOKE CONNECTING LEVER:

The functions of the hour yoke connecting lever are:

1. It disengages intermediate hour yoke and wheel from the hour register wheel.
2. The intermediate hour yoke connecting lever permits the intermediate hour yoke and wheel to engage with the hour register wheel. The hour yoke lever is controlled by the pin "A" of the chronograph pivoted detent.

REFERENCE: Intermediate hour yoke and wheel is Assembly 13.

Chronograph pivoted detent is Assembly 30.

Hour register wheel is Assembly 9.

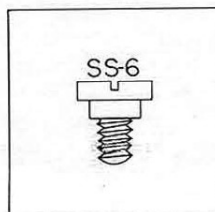

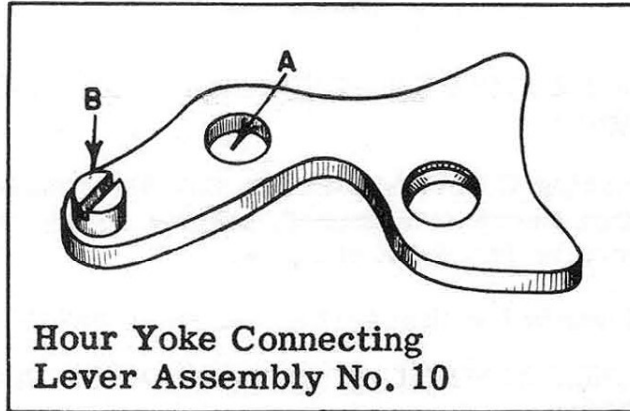

OILING

The hour yoke connecting lever should be slightly moistened with oil at the following points:

1. Shoulder of screw on which lever pivots.
2. Inside surface of hole "A" which contacts post on pivoted detent.

DIAL SIDE

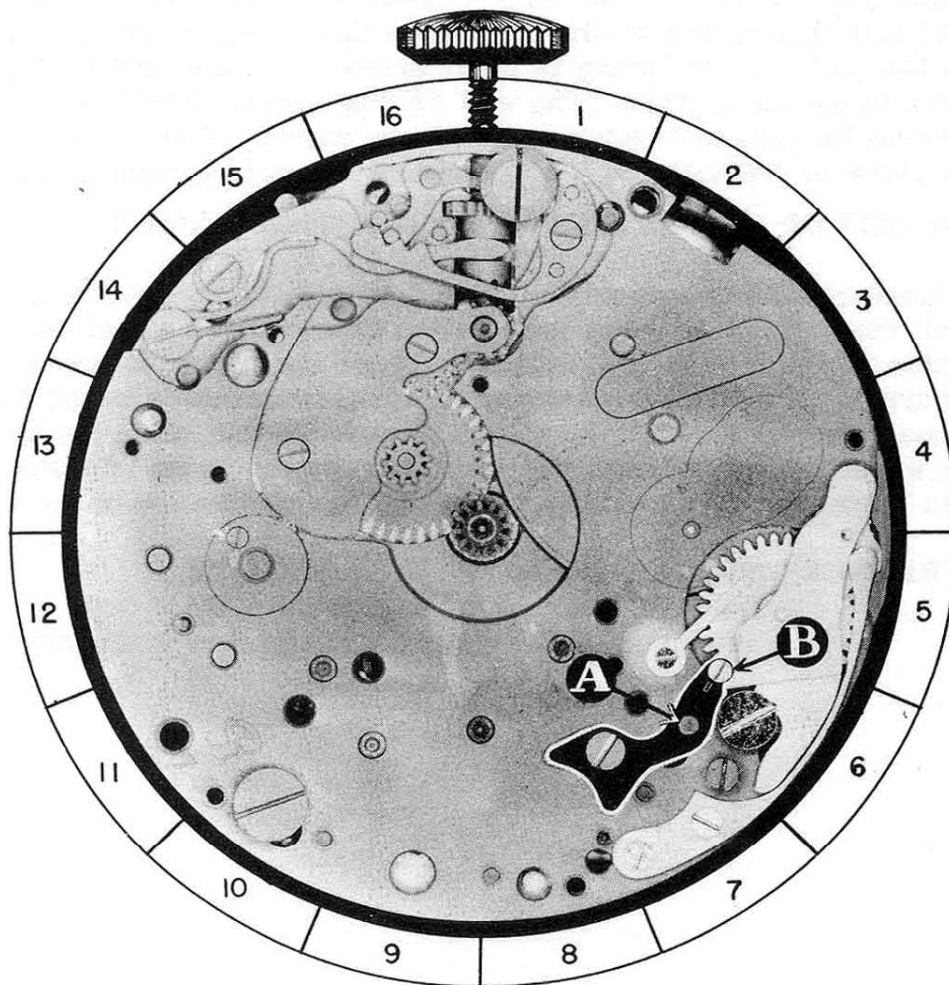

10-A

A. DISASSEMBLY PROCEDURE OF INTERMEDIATE HOUR WHEEL TENSION SPRING:

This tension spring is held in place by beveled countersink screw BS-3. When this screw is removed, tension spring will be free on the plate and can be lifted out of place.

(The shape of screw for this part is shown at bottom of page.)

B. HAZARDS IN DISASSEMBLY OF INTERMEDIATE HOUR WHEEL TENSION SPRING:

This tension spring is very delicate and easily damaged. Care should be taken in removing this spring.

C. ASSEMBLY PROCEDURE OF INTERMEDIATE HOUR WHEEL TENSION SPRING:

Place the intermediate hour wheel tension spring in its proper position on the plate, with hole in intermediate hour tension spring over proper hole in plate. Now replace beveled countersink screw BS-3 that holds this spring in place. Before tightening screw, check to see that end "A" of spring is in its proper position on the wheel, as shown in the photograph. The end "A" of spring should not be touching the pinion on intermediate hour wheel. Now tighten screw, and check to see that end "A" of spring has not changed position.

D. FUNCTION OF INTERMEDIATE HOUR WHEEL TENSION SPRING:

The function of this spring is to hold a tension on the intermediate hour wheel, thus eliminating any lost motion between this wheel and the transmission pinion, or any lost motion between the transmission pinion and the barrel. This allows a smooth steady flow of power to the intermediate hour wheel. This spring makes it possible that when the intermediate hour wheel is engaged with the hour wheel, there is no lost motion between these wheels, to cause an inaccurate registration of the hours.

REFERENCE: Transmission pinion is Assembly 14.
Hour register wheel is Assembly 9.
Intermediate hour yoke and wheel is Assembly 13.

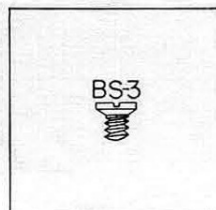

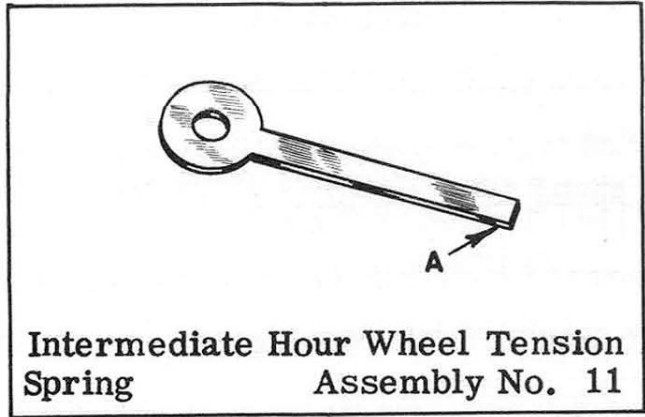

OILING

The intermediate hour wheel tension spring should not be oiled.

DIAL SIDE

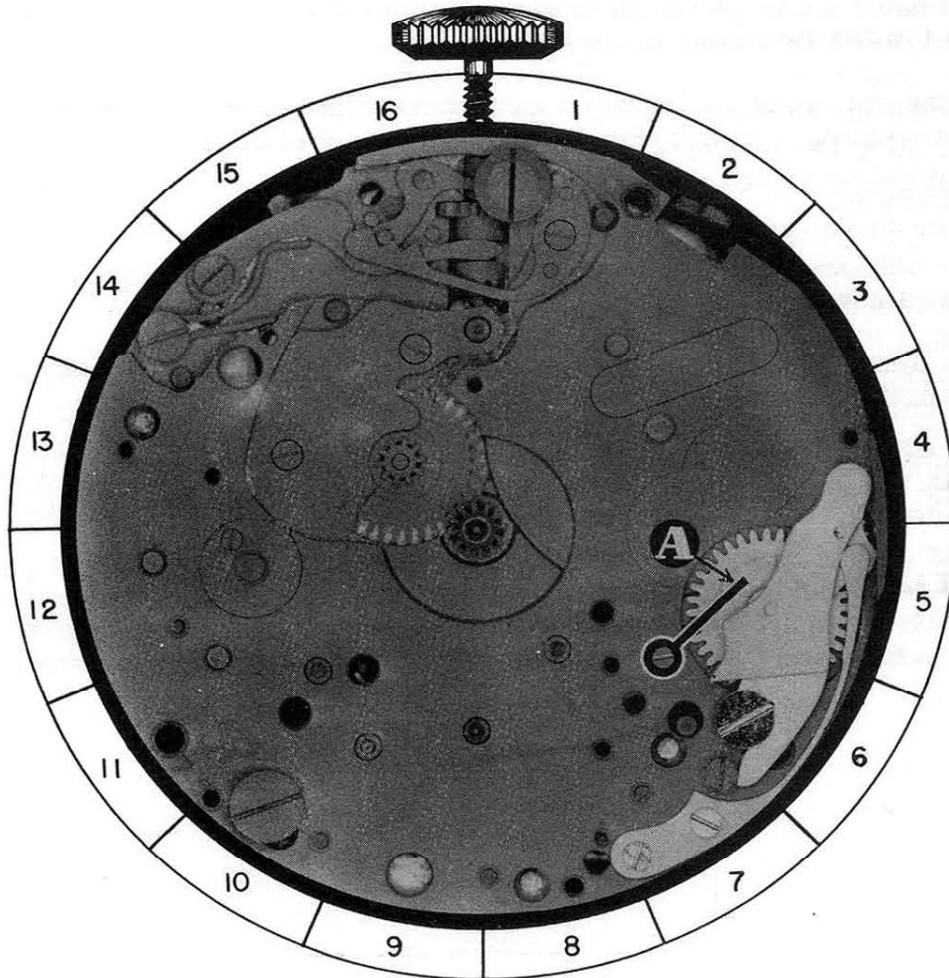

11-A

A. DISASSEMBLY PROCEDURE OF INTERMEDIATE HOUR YOKE SPRING:

This spring is held in place by identical fillister head screws, FS-4 and FS-5. When these screws are removed, the tension spring will be free on the plate, and can be lifted out of place.

(The shape of screws for this part is shown at bottom of page.)

B. ASSEMBLY PROCEDURE OF INTERMEDIATE HOUR YOKE SPRING:

Place the intermediate hour yoke spring in its proper position on the plate, as shown in the photograph. Make sure that end "A" of spring fits on top of the lip on the intermediate hour yoke. Now replace fillister head screws FS-4 and FS-5 that hold this spring in place.

REFERENCE: Intermediate hour yoke and wheel is Assembly 13.

C. FUNCTION OF INTERMEDIATE HOUR YOKE SPRING:

The functions of this spring are:

1. It holds a tension on the intermediate hour yoke and wheel, forcing it toward the center of the watch.
2. The hour yoke spring helps hold intermediate hour yoke in place, preventing it from riding up and coming out of place.

REMARKS:

When adjusting springs for proper tension, it is good to follow this policy as a general rule:

1. A spring should just hold enough tension on a part to perform its function properly.
2. Any excess tension on a part in a chronograph mechanism will cause the chronograph to be harder to work, also causing more wear, etc.

Of course, the amount of pressure the spring should hold on a part is determined in the factory; because of this it is seldom that you should have to adjust a spring. However, you may have to make one of these springs, and the above rules should aid you in setting the proper tension.

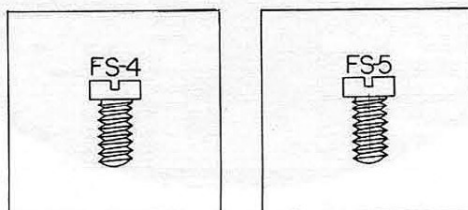

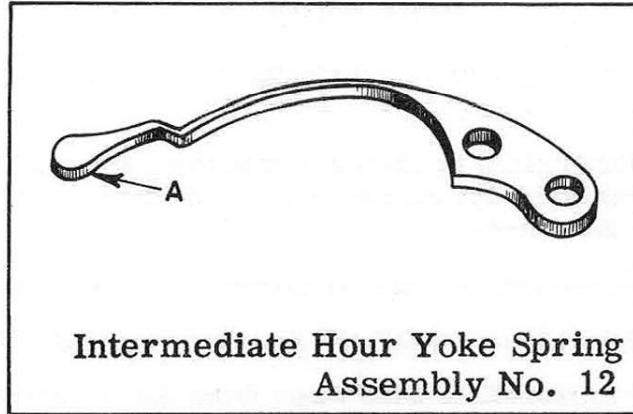

OILING

End "A" of intermediate hour yoke spring should be slightly moistened with oil at point of contact with intermediate hour yoke and wheel.

DIAL SIDE

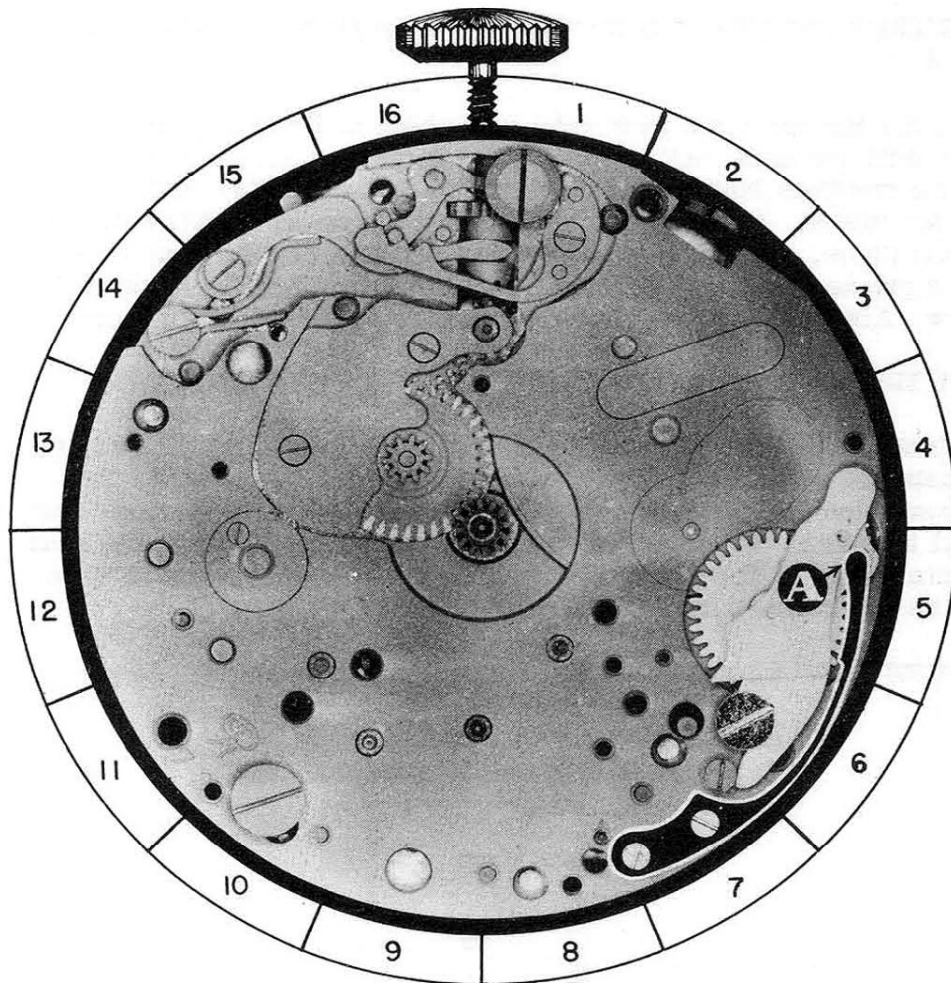

A. DISASSEMBLY PROCEDURE OF INTERMEDIATE HOUR YOKE AND WHEEL:

This yoke is held in place by shouldered screw SS-7 and a stud. After this screw is removed, lift straight up on intermediate hour yoke freeing it from the movement.

(The shape of screw for this part is shown at bottom of page.)

B. DISASSEMBLY PROCEDURE OF INTERMEDIATE HOUR WHEEL:

To remove the intermediate hour wheel from the intermediate hour yoke, remove fillister screw FS-6 that holds the wheel to the intermediate hour yoke. After this screw is removed, the intermediate hour wheel will be free on the yoke and can be lifted out of place.

C. ASSEMBLY PROCEDURE OF INTERMEDIATE HOUR WHEEL ON INTERMEDIATE HOUR YOKE:

Place intermediate hour wheel in its proper position on the intermediate hour yoke. Now replace fillister head screw FS-6. After this screw is replaced, check the wheel to see that it pivots freely under the head of this screw.

D. ASSEMBLY PROCEDURE OF INTERMEDIATE HOUR YOKE AND WHEEL:

Place the intermediate hour yoke and wheel in its proper position on the plate, with the stud "A" on yoke down in proper hole in plate. Turn the intermediate hour wheel slightly, so that it meshes with transmission pinion. Now replace shouldered screw SS-7, that holds this yoke in place. After this screw is replaced, check the yoke to see that it pivots freely on stud and is not binding under the head of this screw. Also check to see that transmission pinion is not binding.

E. FUNCTION OF INTERMEDIATE HOUR YOKE AND WHEEL:

The function of the hour yoke is to engage and disengage the intermediate hour wheel with the hour register wheel and to hold the transmission pinion in place. When engaged, the intermediate hour wheel transfers the power from the transmission pinion to the hour register wheel. The intermediate hour wheel continues to turn as long as the watch is running.

REFERENCE: Intermediate hour wheel is shown as "B" in the isometric drawing.

Hour register wheel is Assembly 9.

Transmission pinion is Assembly 14.

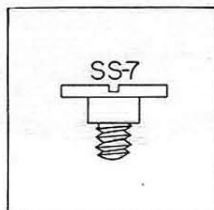

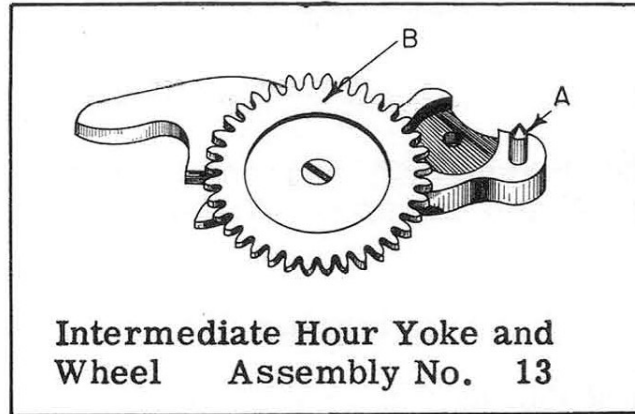

OILING

The following points on intermediate hour yoke and wheel should be slightly moistened with oil:

1. Post on which intermediate hour wheel pivots.
2. Top pivot on transmission pinion.

DIAL SIDE

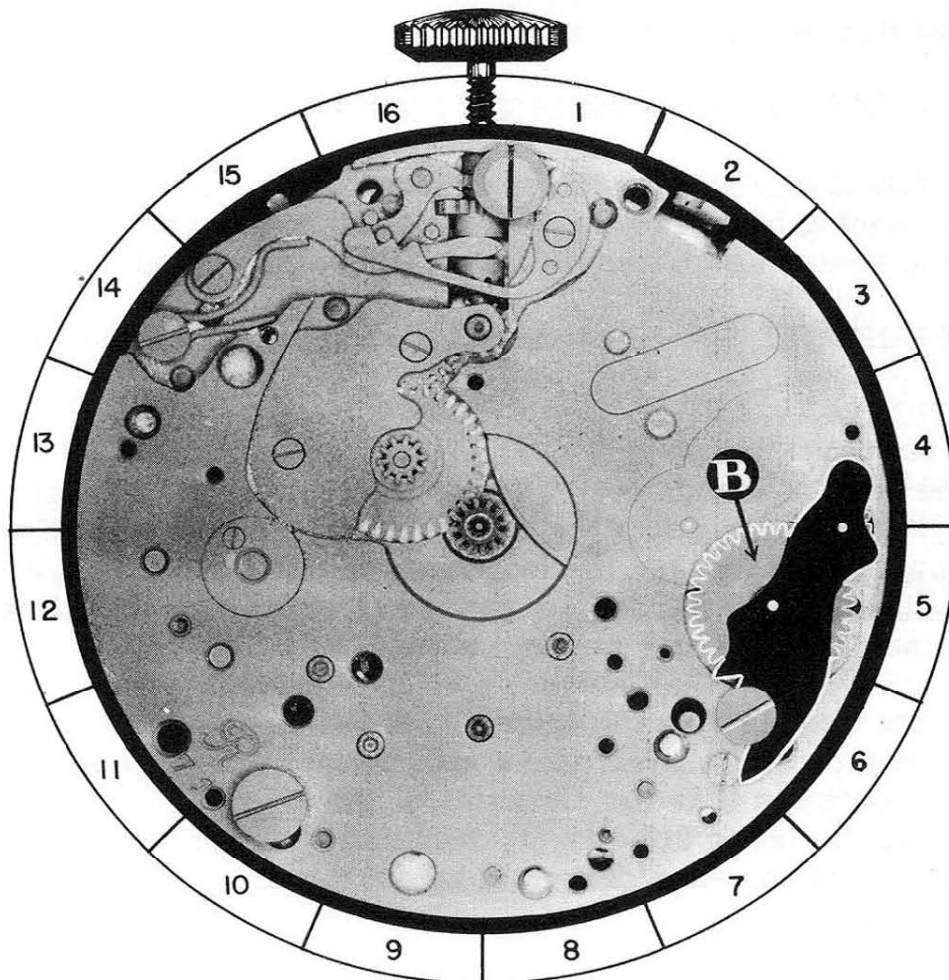

13-A

A. DISASSEMBLY PROCEDURE OF TRANSMISSION PINION:

To remove this pinion, grip pivot on pinion with a pair of tweezers and lift straight up on pivot, lifting pinion out of place.

NOTICE

The removal of this part completes the disassembly of the dial side of this mechanism. Now turn the movement over with the train side facing you and continue to disassemble the mechanism by following the instructions in this book.

B. ASSEMBLY PROCEDURE OF TRANSMISSION PINION:

Place pinion in position, in recess in plate, with pivot on pinion in pivot hole. Either end of this pinion may be placed down, as both ends of pinion are identical. The next part to be replaced holds this pinion in place.

C. FUNCTION OF TRANSMISSION PINION:

The function of this pinion is to transmit the power from the main spring barrel to the intermediate hour wheel. This pinion continues to turn as long as the watch is running.

REFERENCE: Intermediate hour wheel is Assembly 13-B.

D. NOTICE:

If the head of a shouldered screw tightens down on a part preventing it from functioning properly, the shoulder of the screw is shorter than the thickness of the lever. To correct this, the head of the shouldered screw must be cut back to lengthen the shoulder on the screw.

I do not want to give the impression that lengthening the shoulder on shouldered screw will always free a part under it; many times it is the diameter of the shoulder that is causing the lever to be tight. Naturally, to correct this, the diameter of the shoulder must be cut down slightly for freedom.

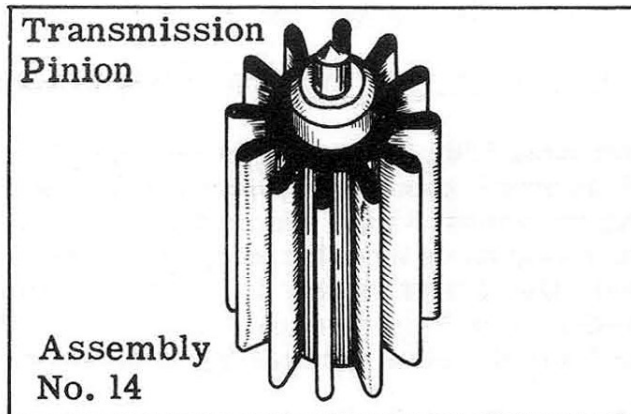

OILING

The bottom pivot on transmission pinion should be slightly moistened with oil before replacing this part. The top pivot is oiled after the intermediate hour yoke and wheel is replaced.

DIAL SIDE

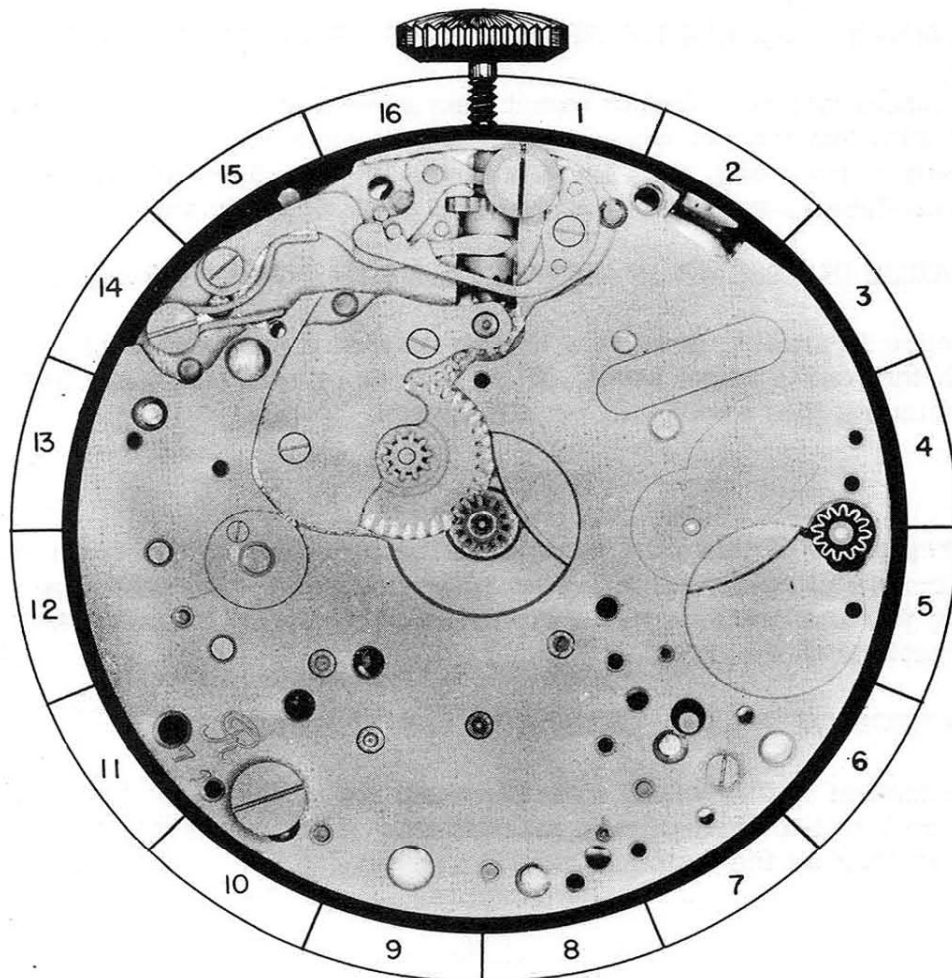

14-A

A. DISASSEMBLY PROCEDURE OF WHEEL OVER FOURTH WHEEL:

Wheel over fourth wheel fits friction tight on long pivot of fourth wheel pinion. This wheel should be removed with a sweep wheel remover, but can be removed with two small, thin edge screw-drivers. The screw-drivers are placed opposite each other under hub "A" of wheel. One screw-driver is turned clockwise, while the other screw-driver is turned counter-clockwise. This will loosen the wheel from the pivot, permitting it to be lifted out of place.

B. HAZARDS IN DISASSEMBLY OF WHEEL OVER FOURTH WHEEL:

Wheel over fourth wheel fits over the very thin pivot of fourth wheel pinion, which is, as you know, very delicate and easily bent or broken. The main reason why we select this part to be removed first, is to lessen the hazards of bending the long pivot on the fourth wheel pinion, when removing the other parts of the chronograph mechanism. If the sweep wheel remover is held perfectly upright in removing wheel, hazard of bending fourth wheel pivot will be eliminated.

C. ASSEMBLY PROCEDURE OF WHEEL OVER FOURTH WHEEL:

This wheel fits over fourth wheel long pivot and should be placed on pivot with hub "A" of wheel down. Wheel over fourth wheel should be pushed down until it is level with the intermediary wheel. A hollow flat-faced punch should be used to push wheel down.

D. HAZARDS IN ASSEMBLY OF WHEEL OVER FOURTH WHEEL:

Use care in staking down this wheel, so that you do not bend or break the fourth wheel pivot. If movement is held level, the hazard of replacing this wheel will be eliminated.

NOTICE

The replacing of this part completes the assembly of the train side of chronograph mechanism. Now turn movement over with dial side facing you and continue to assemble mechanism by following the instructions in this book.

E. FUNCTION OF WHEEL OVER FOURTH WHEEL:

The function of this wheel is to transmit the power from the train of the watch to the chronograph mechanism. This wheel continues to turn as long as the watch is running.

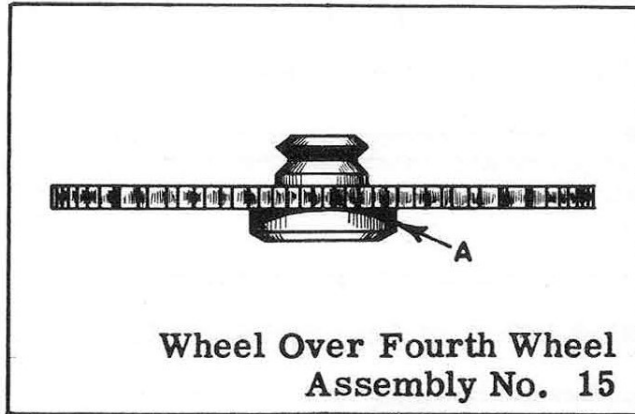

OILING

The wheel over fourth wheel should not be oiled.

TRAIN SIDE

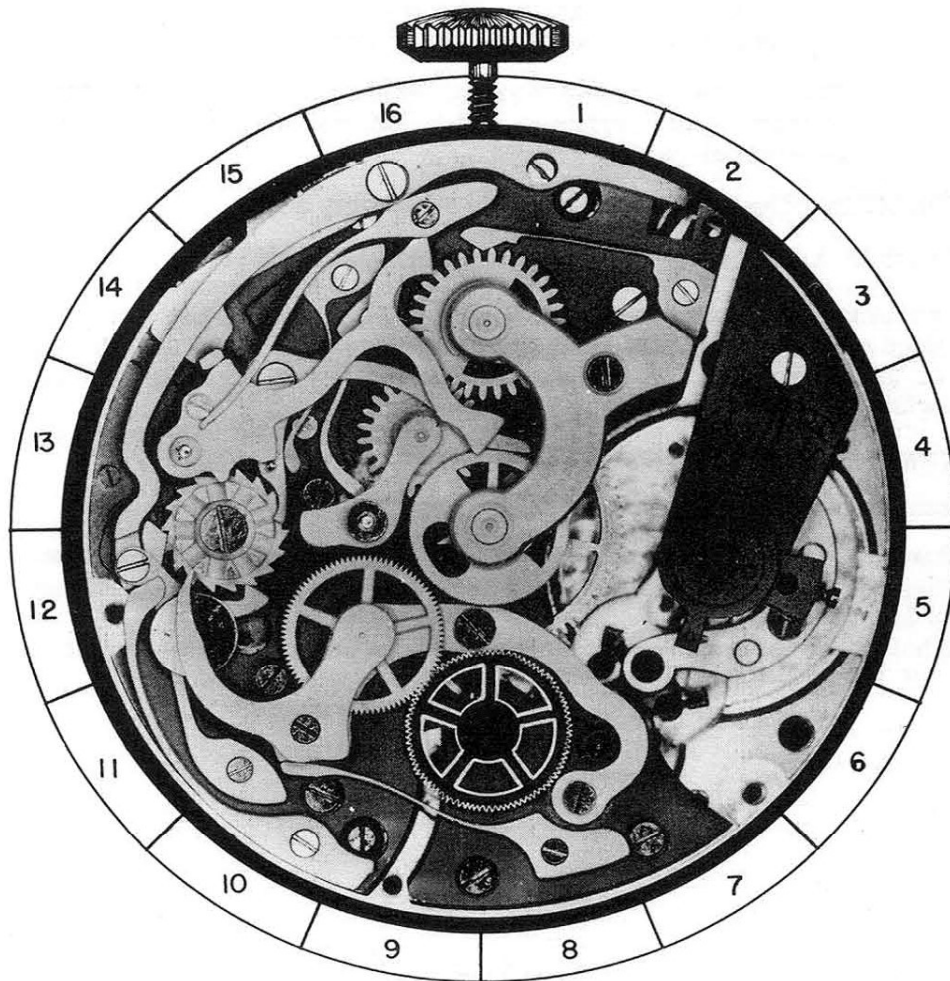

15-A

A. DISASSEMBLY PROCEDURE OF MINUTE REGISTER PAWL:

This pawl is held in place by beveled countersink screw BS-4 and steady pins. Remove this screw and loosen pawl by sliding a thin blade screw-driver under pawl. When steady pins are free, pawl may be lifted out of place.

(The shape of screw for this part is shown at bottom of page.)

B. HAZARDS IN DISASSEMBLY OF MINUTE REGISTER PAWL:

The blade on this pawl is extremely delicate and can be easily damaged by a slight slip of the screw-driver. Care must be taken in removing this pawl, so as not to harm it in any way.

C. ASSEMBLY PROCEDURE OF MINUTE REGISTER PAWL:

Place the pawl in its proper position on the plate, with steady pins entering proper holes. Now press down to proper place with back of tweezers and replace beveled countersink screw BS-4 that holds this pawl in place.

CAUTION: The amount of tension that end "A" of pawl holds on minute register wheel should be very light, yet strong enough to keep the minute register wheel stationary until the wheel is turned by the chronograph mechanism. Too strong a tension on minute register wheel may cause the watch to stop.

The end "A" of pawl must be highly polished and free from pits of rust. Any roughness at this location will cause pawl not to function properly.

REFERENCE: Minute register wheel is Assembly 24.

D. HAZARDS IN ASSEMBLY OF MINUTE REGISTER PAWL:

When pressing pawl down to proper place, make sure that the end "A" of pawl does not set on top of a tooth on minute register wheel as this will bend or break the pawl. The pawl should mesh in between two teeth on minute register wheel.

E. FUNCTION OF MINUTE REGISTER PAWL:

The minute register pawl serves two purposes:

1. This pawl correctly spaces the turning of the minute register wheel. This eliminates the possibility of the minute register wheel setting at an incorrect position.
2. It holds a tension on minute register wheel so that a bump or jar cannot alter the position of this wheel.

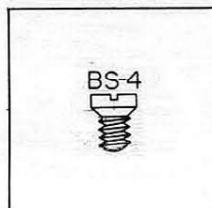

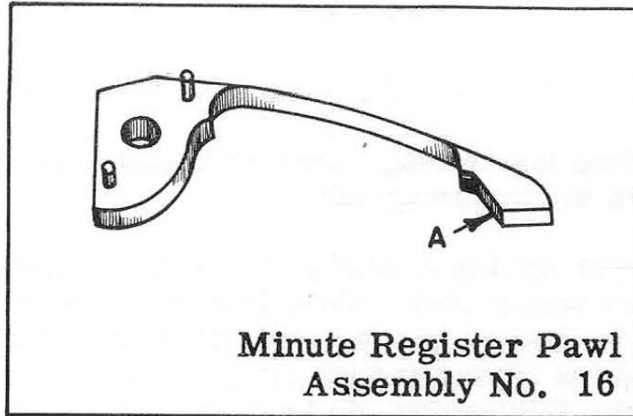

OILING

The minute register pawl should not be oiled.

TRAIN SIDE

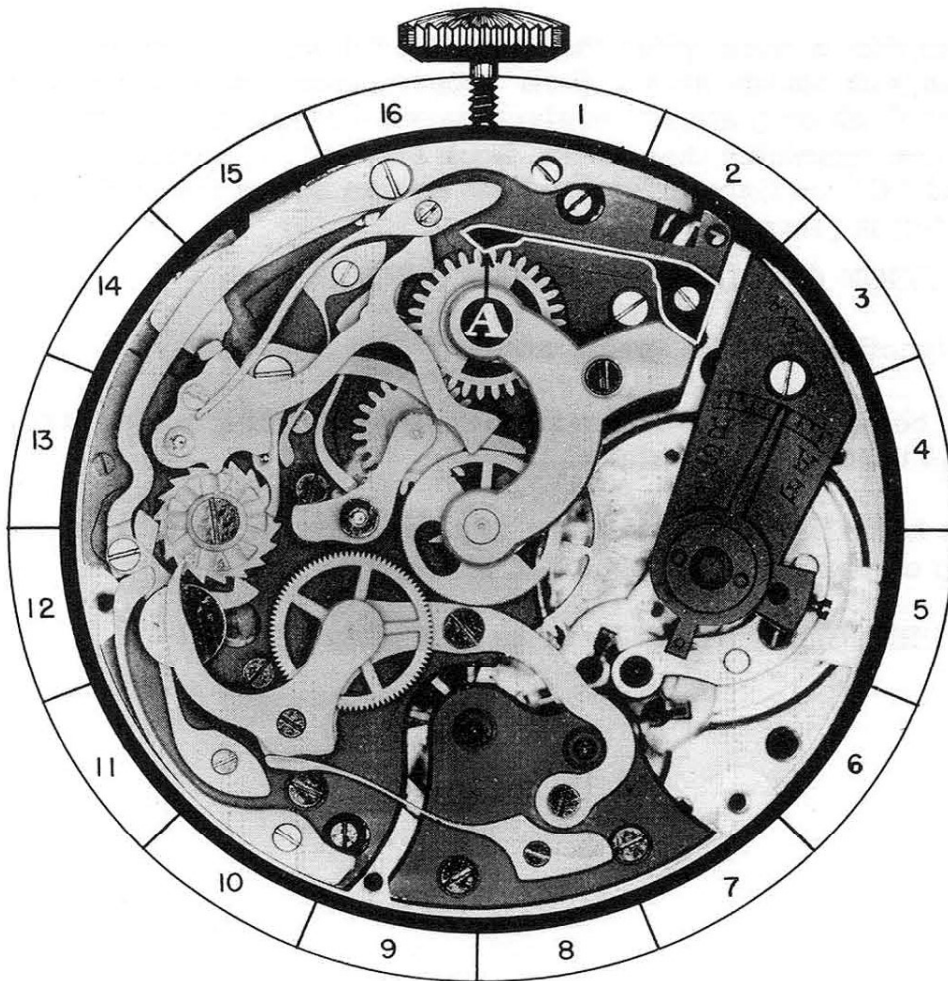

A. DISASSEMBLY PROCEDURE OF FLYBACK LEVER SPRING:

(Before removing this spring, make sure that flyback lever is in the position shown in the photograph.)

The flyback lever spring is held in place by beveled countersink screw BS-5 and steady pins. When this screw is removed, this spring can be loosened from the plate by sliding a thin blade screw-driver between the spring and the plate. After steady pins are free in holes in plate, this spring can be lifted out of place.

REFERENCE: Flyback lever is Assembly 18.

(The shape of screw for this part is shown at bottom of page.)

B. ASSEMBLY PROCEDURE OF FLYBACK LEVER SPRING:

(Before replacing this spring, make sure that flyback lever is in the position shown in the photograph.)

When this is done, place the spring in its proper position on the plate, with steady pins in their proper holes. Now press spring down flush on plate, and replace beveled countersink screw BS-5. Before tightening this screw, hook end "A" of spring on screw-head "C" on flyback lever. Now tighten screw that holds this spring in place.

C. FUNCTION OF FLYBACK LEVER SPRING:

The functions of this spring are:

1. It holds a tension on the flyback lever, forcing it away from the center of the watch.
2. It holds flyback lever down in place, preventing it from riding up on post and coming out of place.

REFERENCE: Flyback lever is Assembly 18.

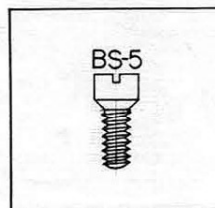

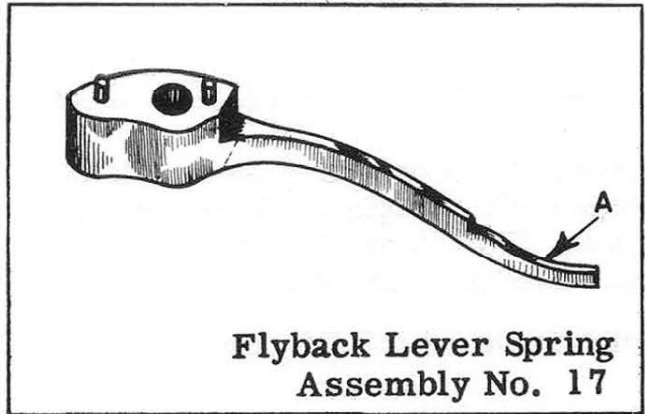

Flyback Lever Spring
Assembly No. 17

OILING

End "A" of flyback lever spring should be slightly moistened with oil at point of contact with screw "C" on flyback lever..

TRAIN SIDE

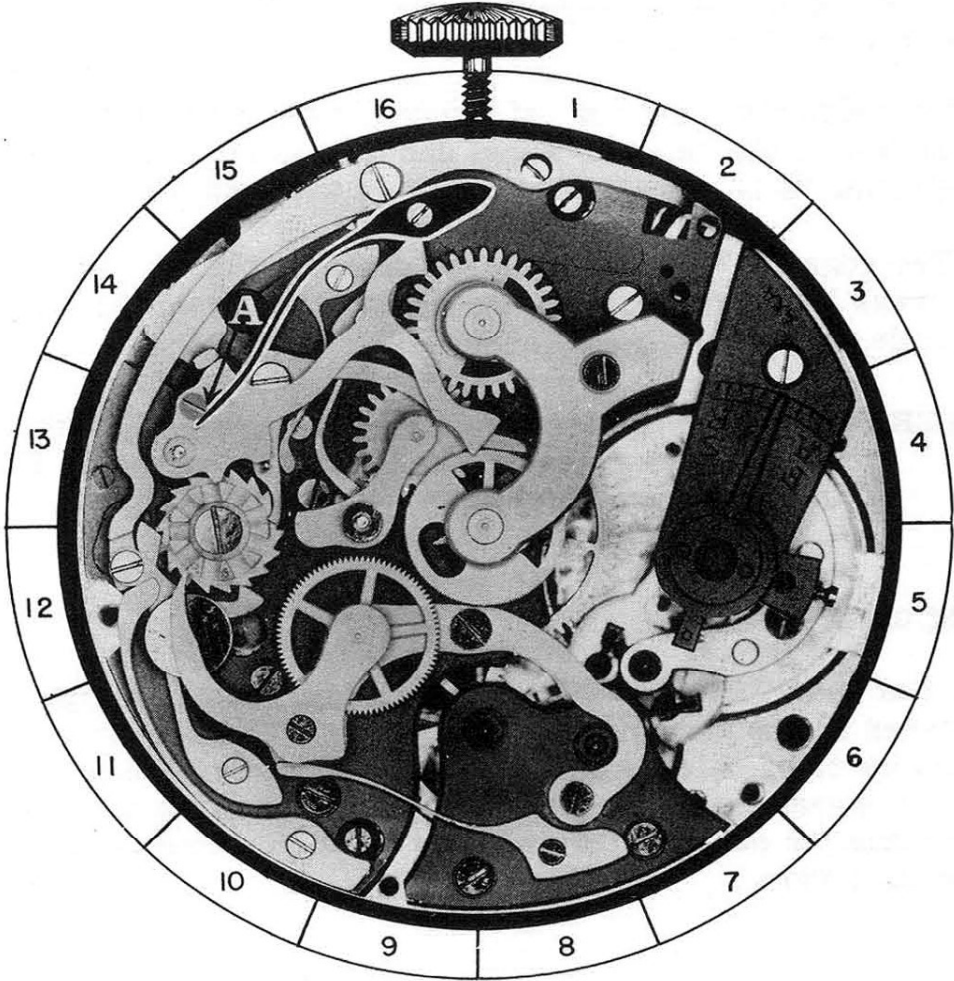

17-A

A. DISASSEMBLY PROCEDURE OF FLYBACK LEVER:

The flyback lever pivots on a post on the plate. To remove this lever, simply lift straight up on lever, freeing it from post on the plate. (To remove flyback lever, it must be in the position shown in the photograph.)

B. ASSEMBLY PROCEDURE OF FLYBACK LEVER:

The flyback lever should be replaced with the screw head "C" up. Now place the flyback lever in position, with hole in bushing in flyback lever over post on plate, and press lever down on post.

C. FUNCTION OF FLYBACK LEVER:

The functions of the flyback lever are:

1. It disengages the intermittent wheel from the seconds wheel dart tooth.
2. The ends "A" and "B" of flyback lever contact the hearts on the seconds wheel and minute register wheel, forcing these wheels to return to a zero position.
3. The edge "D" on flyback lever contacts pin "A" on brake lever, disengaging the brake lever from the seconds wheel.

REFERENCE: Seconds wheel dart tooth is Assembly 22C.
Minute register wheel heart is Assembly 24B.
Seconds wheel heart is Assembly 22B.
Brake lever is Assembly 19.

REMARKS:

The flat ends "A" and "B" of flyback lever must be highly polished as any roughness or pits of rust at this location may cause the flyback lever not to function properly. When polishing ends, care should be taken not to shorten one end more than the other or they will not function properly as described above.

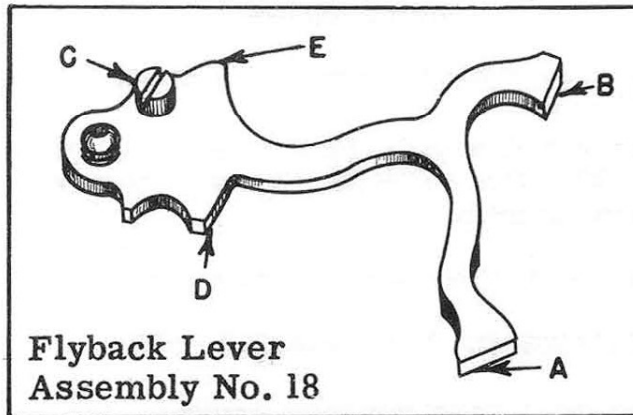

OILING

Slightly moisten flyback lever with oil at the following points:

1. The post on which flyback lever pivots.
2. Point "D" that contacts pin "A" on brake lever.
3. Point "E" that contacts push piece for setting back to zero.

TRAIN SIDE

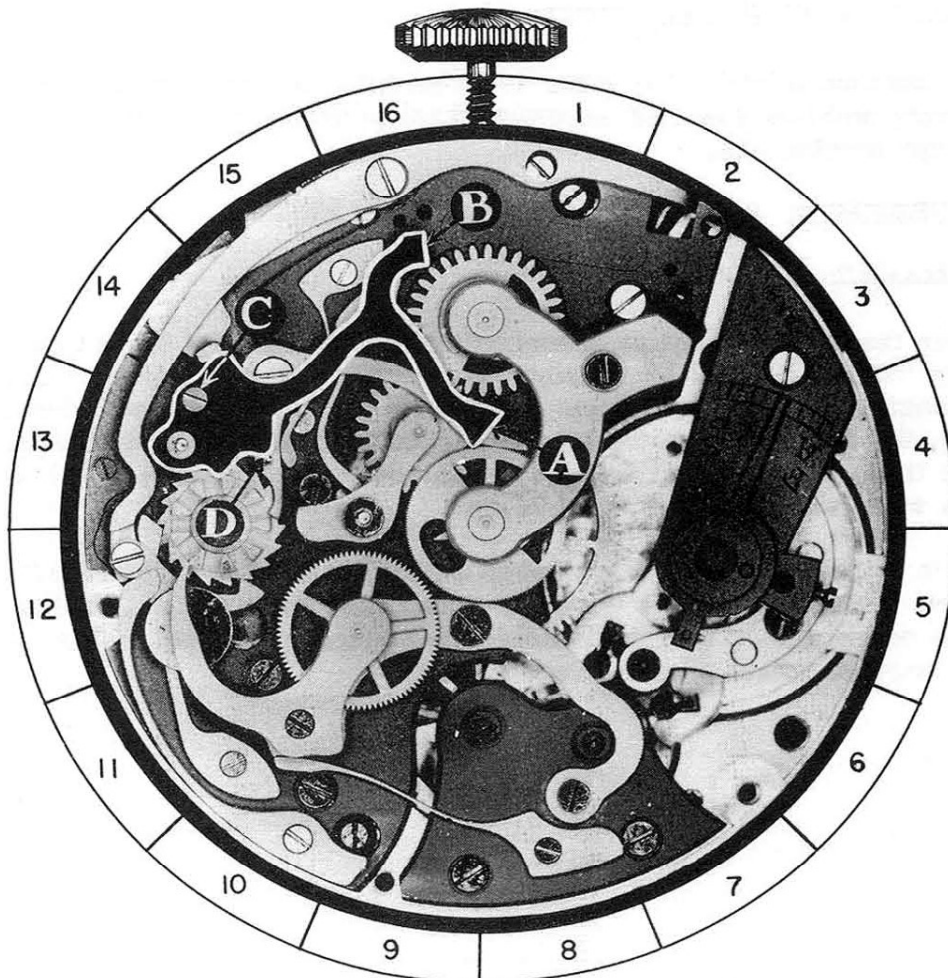

A. DISASSEMBLY PROCEDURE OF BRAKE LEVER:

The brake lever is held in place by shouldered screw SS-8 and pivots on this screw. After this screw is removed, lift straight up on brake lever, lifting it out of place.

(The shape of screw for this part is shown at bottom of page.)

B. HAZARDS IN DISASSEMBLY OF BRAKE LEVER:

Hold finger over lever, when removing screw, so that screw does not shoot away and become lost.

C. ASSEMBLY PROCEDURE OF BRAKE LEVER:

Place the brake lever on plate in its proper position. The brake lever spring should contact surface "C" on brake lever. Now place hole in brake lever over screw hole in plate and replace shouldered screw SS-8. Check the brake lever to see that it pivots freely under head of this screw.

D. FUNCTION OF BRAKE LEVER:

The function of the brake lever is to hold the seconds wheel in a stationary position when the seconds wheel is disengaged from the chronograph mechanism.

REFERENCE: Seconds wheel is Assembly 22.

REMARKS:

When the flyback lever is brought toward the center of the watch, the edge "D" on flyback lever contacts pin "A" on brake lever. This disengages end "B" on brake lever from the seconds wheel. Naturally, the brake lever must be disengaged from the seconds wheel at this time, so that the flyback lever can bring the seconds wheel back to a zero position.

When the castle wheel is turned to a position to permit intermediary wheel to engage with the seconds wheel, the castle wheel at the same time disengages the brake lever from the seconds wheel. This frees the seconds wheel so that it can turn.

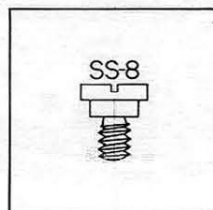

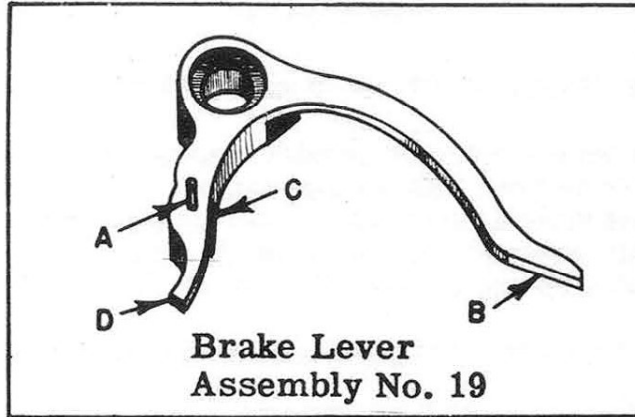

OILING

The following points on brake lever should be slightly moistened with oil:

1. Shoulder of screw on which brake lever pivots.
2. Surface "C" that contacts end "A" of brake lever spring.

TRAIN SIDE

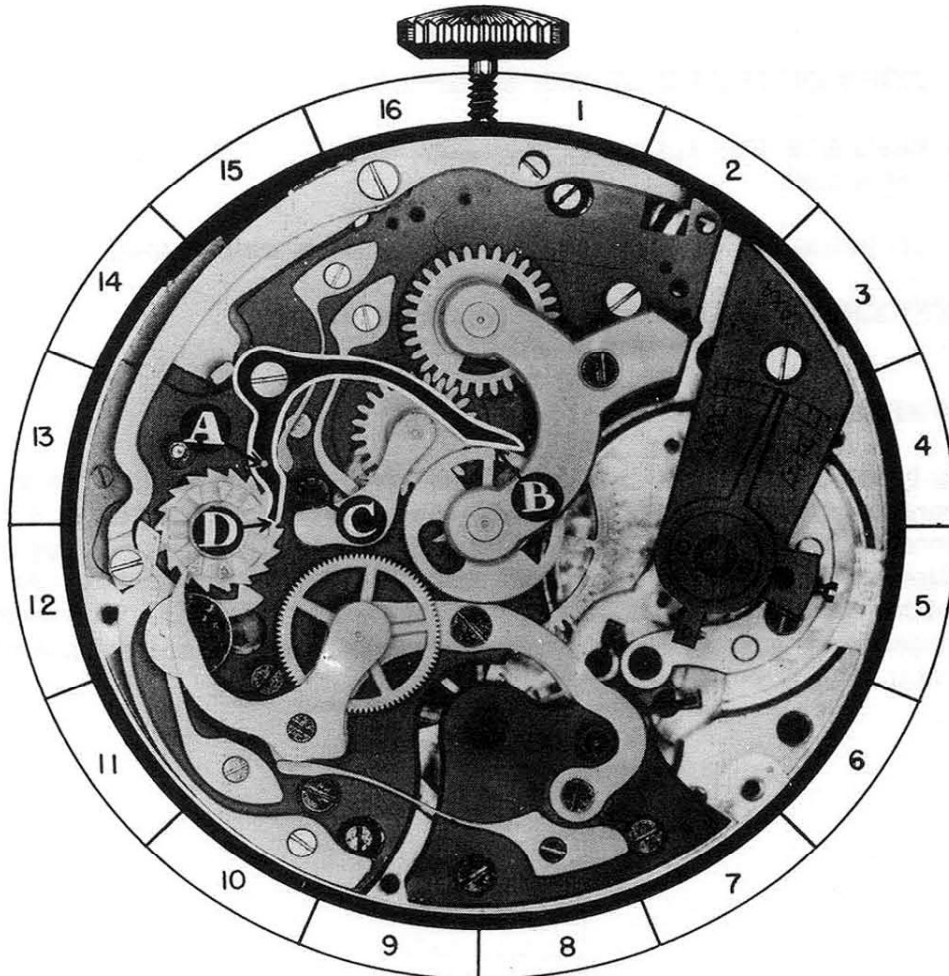

19-A

A. DISASSEMBLY PROCEDURE OF BRAKE LEVER SPRING:

This spring is held in place by beveled countersink screw BS-6 and steady pins. To remove this spring, remove beveled countersink screw BS-6, and slide a finely-sharpened screw-driver under the base of the spring to loosen the spring from the plate. After steady pins are free in plate, spring can be lifted out of place.

(The shape of screw for this part is shown at bottom of page.)

B. HAZARDS IN DISASSEMBLY OF BRAKE LEVER SPRING:

When sliding a screw-driver under this spring, care should be taken not to mar the plate.

C. ASSEMBLY PROCEDURE OF BRAKE LEVER SPRING:

Place the brake lever spring in its proper position on the plate, as shown in the photograph. The steady pins on spring must be entering the proper holes in plate. Now press spring down flush on plate, and replace beveled countersink screw BS-6, that holds this spring in place.

D. FUNCTION OF BRAKE LEVER SPRING:

The function of this spring is to engage end "B" of brake lever with seconds wheel.

(At this point, the brake lever has not yet been assembled.)

REFERENCE: Brake lever is Assembly 19.
Castle wheel is Assembly 36.

REMARKS:

This type of chronograph is called the semi-instantaneous type of chronograph. The minute register hand is stationary until the 58th second of registration. Between the 58th and 60th second of registration, the minute register hand moves forward very slowly. At the 60th second of registration, the minute register hand will move forward very quickly to complete the registration of one minute on the dial.

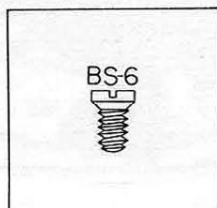

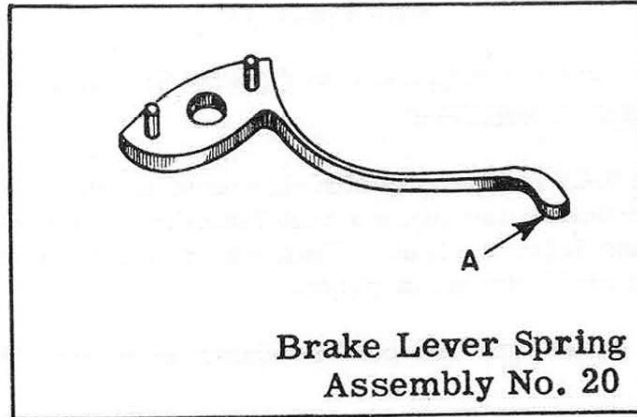

OILING

The end "A" of brake lever spring is oiled after the next part is replaced.

TRAIN SIDE

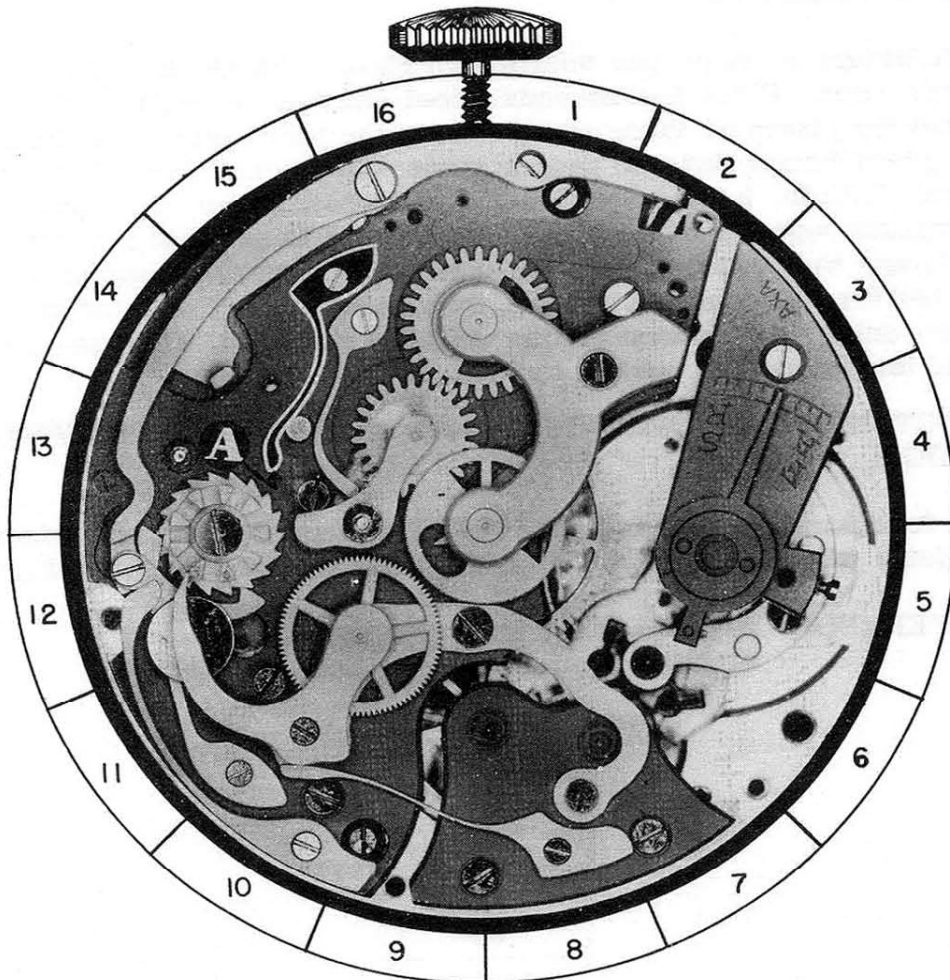

20-A

A. DISASSEMBLY PROCEDURE OF SECONDS WHEEL AND MINUTE REGISTER WHEEL BRIDGE:

This bridge is held in place by fillister head screw FS-7 and steady pins. Remove screw, and slide a thin blade screw-driver under bridge to loosen it from plate. When steady pins are free in plate, the bridge can be lifted out of place.

(The shape of screw for this part is shown at bottom of page.)

B. HAZARDS IN DISASSEMBLY OF SECONDS WHEEL AND MINUTE REGISTER WHEEL BRIDGE:

When loosening bridge from plate, be sure to keep bridge level, as any twisting of bridge may burr pivots on seconds wheel or minute register wheel or may chip the jewels in the bridge. Also be careful not to mar the plate or bridge with screw-driver when loosening bridge from plate.

C. ASSEMBLY PROCEDURE OF SECONDS WHEEL AND MINUTE REGISTER WHEEL BRIDGE:

Place bridge in its proper position on plate, with steady pins over proper holes. Place the seconds wheel and minute register wheel so that the pivots on these wheels enter the jewel holes in bridge. Now press bridge down to proper place with back of tweezers, and replace fillister head screw FS-7. After this bridge is replaced, the minute register wheel should be checked to see that it pivots freely and has proper endshake. The seconds wheel should also be checked for freedom. Of course, the seconds wheel will not spin freely, unless the tension on this wheel is released. (The seconds wheel tension spring holds a tension on this wheel.)

D. FUNCTION OF SECONDS WHEEL AND MINUTE REGISTER WHEEL BRIDGE:

The function of this bridge is to hold the seconds wheel and minute register wheel in position so these wheels can function properly.

REFERENCE: Seconds wheel is Assembly 22.
Minute register wheel is Assembly 24.

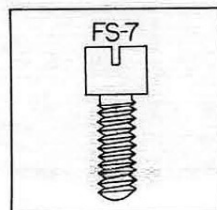

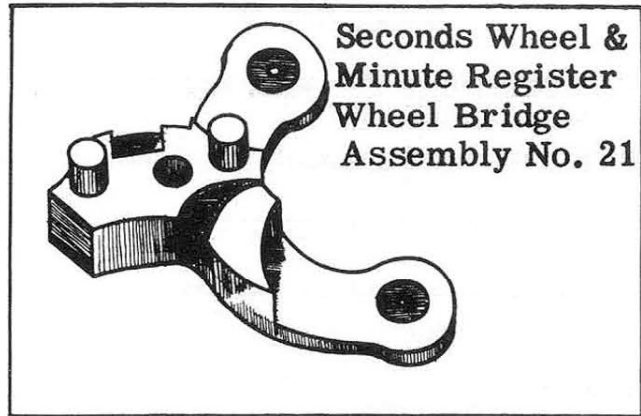

OILING

The pivots in the jewels in this bridge should be oiled as you usually oil the train pivots in a watch.

TRAIN SIDE

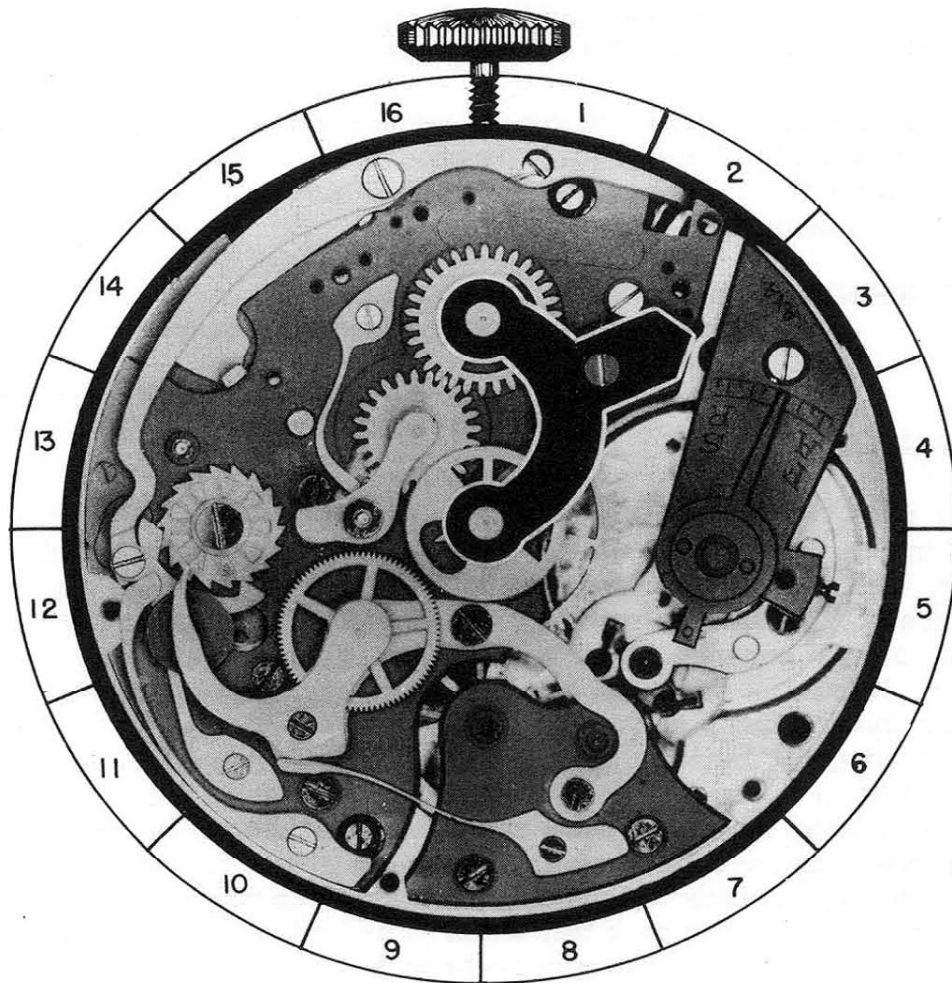

21- A

A. DISASSEMBLY PROCEDURE OF SECONDS WHEEL:

To remove the seconds wheel, simply lift it out of place.

B. ASSEMBLY PROCEDURE OF SECONDS WHEEL:

Place the seconds wheel in position with the long pivot "A" down in hole in center wheel pinion.

C. FUNCTION OF SECONDS WHEEL:

The functions of the seconds wheel are:

1. The seconds wheel registers the seconds that have elapsed since the beginning of the registration. This is done by a hand being attached to the long pivot "A" on seconds wheel.
2. The seconds wheel must move the minute register wheel forward one tooth each time the seconds wheel makes one revolution. This is done by dart tooth "C" attached to the seconds wheel. This dart tooth meshes with the teeth on the intermittent wheel which, in turn, move the minute register wheel one tooth.
3. The seconds wheel must return the seconds hand to zero position, when the flyback lever is brought in contact with the heart on this wheel. Seconds wheel heart is shown as "B" in the isometric drawing.

REFERENCE: Flyback lever is Assembly 18.

Dart tooth on seconds wheel is shown as "C" on isometric drawing.

Intermittent lever and wheel assembly is Assembly 26.

REMARKS:

When the flyback lever is forced toward the center of the watch, and held in this position, check the seconds wheel and minute register wheel with a very fine broach to see if either of these wheels can be turned. The minute register wheel should turn slightly at this point, but the seconds wheel should be held very tight by the flyback lever. It is most essential for the seconds wheel to be held stationary by the flyback lever at a zero position. In the case of the minute register wheel, it does not have to be held absolutely stationary by the flyback lever. The minute register pawl will serve this purpose. The only thing that the minute register wheel should be checked for is, to see that the minute register wheel will not turn far enough to one side or the other to let the minute register pawl drop into another space between the next two teeth. This will assure that the minute register wheel will always be brought back to a zero position.

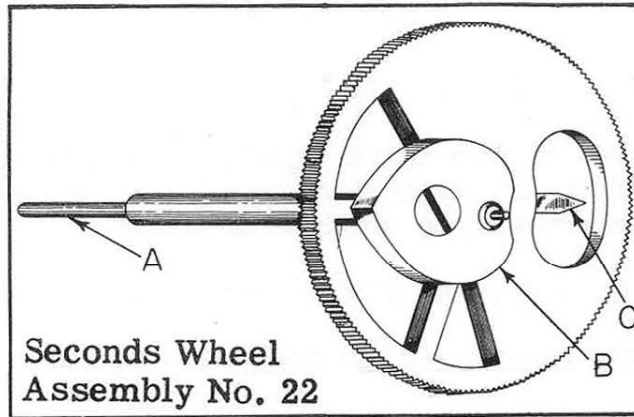

OILING

The top pivot on seconds wheel should be oiled after bridge for this wheel is replaced. Oil this pivot as you usually oil a train pivot in a watch.

TRAIN SIDE

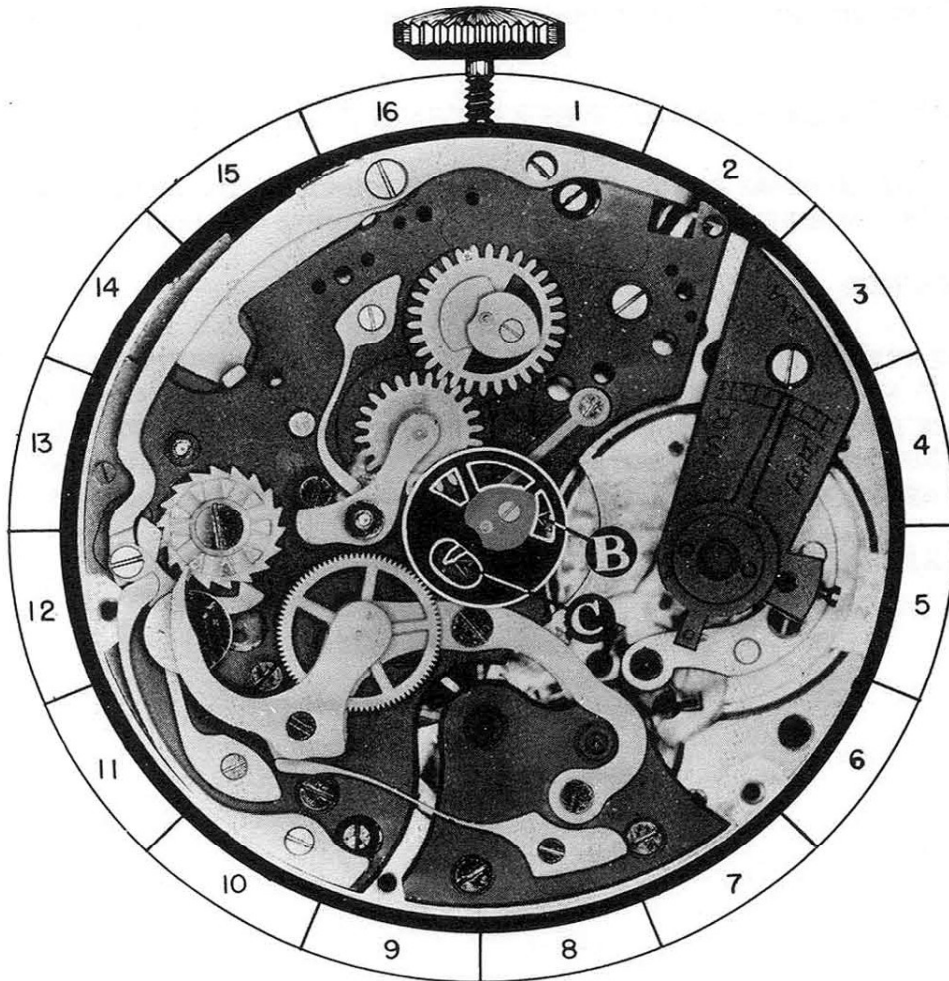

22-A

PART NO. 23

A. DISASSEMBLY PROCEDURE OF SECONDS WHEEL TENSION SPRING:

The seconds wheel tension spring is held in place by fillister head screw FS-8. After this screw is removed, the tension spring will be free on the plate and may be lifted out of place.

(The shape of screw for this part is shown at bottom of page.)

B. ASSEMBLY PROCEDURE OF SECONDS WHEEL TENSION SPRING:

Place seconds wheel tension spring in its proper position, with hole in spring over proper hole in plate. Replace fillister screw FS-8, but before tightening screw, make sure that end "A" of spring is not over the seconds wheel hole. End "A" of this spring should fit right along side of the center wheel pivot hole. It should not fit over it. The proper position of this spring is shown in the photograph. After spring is replaced and screw is tight, check to make sure that tension spring is still in its proper position, as shown in the photograph. This spring should also be checked to see that it is right side up. The way to determine the side that should be up is, to see that end "A" of spring is above the level of the plate, and the polished side of spring is facing up.

C. FUNCTION OF SECONDS WHEEL TENSION SPRING:

This spring holds a tension on seconds wheel, so that it turns with a smooth, even action, with no irregular jumping or jerking.

REMARKS:

When replacing this spring, it is important to see that the end "A" of this spring is in its proper position. If it is not, the end "A" of spring may hold a tension on the seconds wheel staff, causing excess friction, which may cause the watch to stop. The seconds wheel tension spring should hold only an upward tension on the seconds wheel.

REFERENCE: Seconds wheel is Assembly 22.

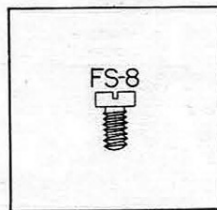

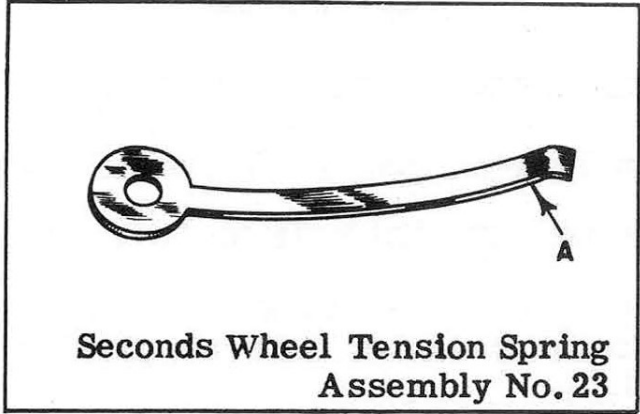

OILING

The seconds wheel tension spring should not be oiled.

TRAIN SIDE



23-A

A. DISASSEMBLY PROCEDURE OF MINUTE REGISTER WHEEL:

To remove this wheel, simply lift it out of place.

B. HAZARDS IN DISASSEMBLY OF MINUTE REGISTER WHEEL:

When removing this wheel, lift wheel straight up out of watch, as any twisting may bend or break the pivot on the minute register wheel.

C. ASSEMBLY PROCEDURE OF MINUTE REGISTER WHEEL:

Place the minute register wheel in its proper position in the watch, as shown in the photograph. The long pivot "A" should be placed down.

D. FUNCTION OF MINUTE REGISTER WHEEL:

The function of the minute register wheel is to record the minutes that have elapsed since the beginning of the registration of the chronograph sweep second hand. The heart "B" on the minute register wheel is used in returning the hand to zero.

REMARKS:

The minute register wheel is returned to a zero position by the flyback lever contacting the heart "B" on minute register wheel. The heart on this wheel is set eccentric. When the flat end of flyback lever contacts eccentric heart, it forces the heart to turn. The heart will turn until the flat end of flyback lever sets across the two lobes at top of heart. With the pressure equalized at these two points, it would turn no further, and this would be a zero position.

If this wheel has turned less than 160 degrees from a zero position when the flyback lever is brought in contact with the heart, it will turn in the opposite direction to which it was turning, to bring this wheel to a zero position. On the other hand, if the wheel is turned past 160 degrees from a zero position, the flyback lever will force the heart to continue to turn in the direction it was turning until it reaches a zero position. The degrees used above are approximate as the degree varies in most chronographs from 150 degrees to 170 degrees.

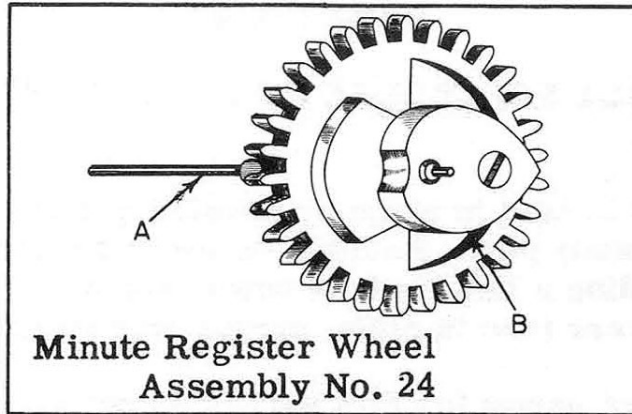

OILING

The top and bottom pivots on this wheel should be oiled after bridge for this wheel is replaced. Oil these pivots as you usually oil the train pivots in a watch.

TRAIN SIDE

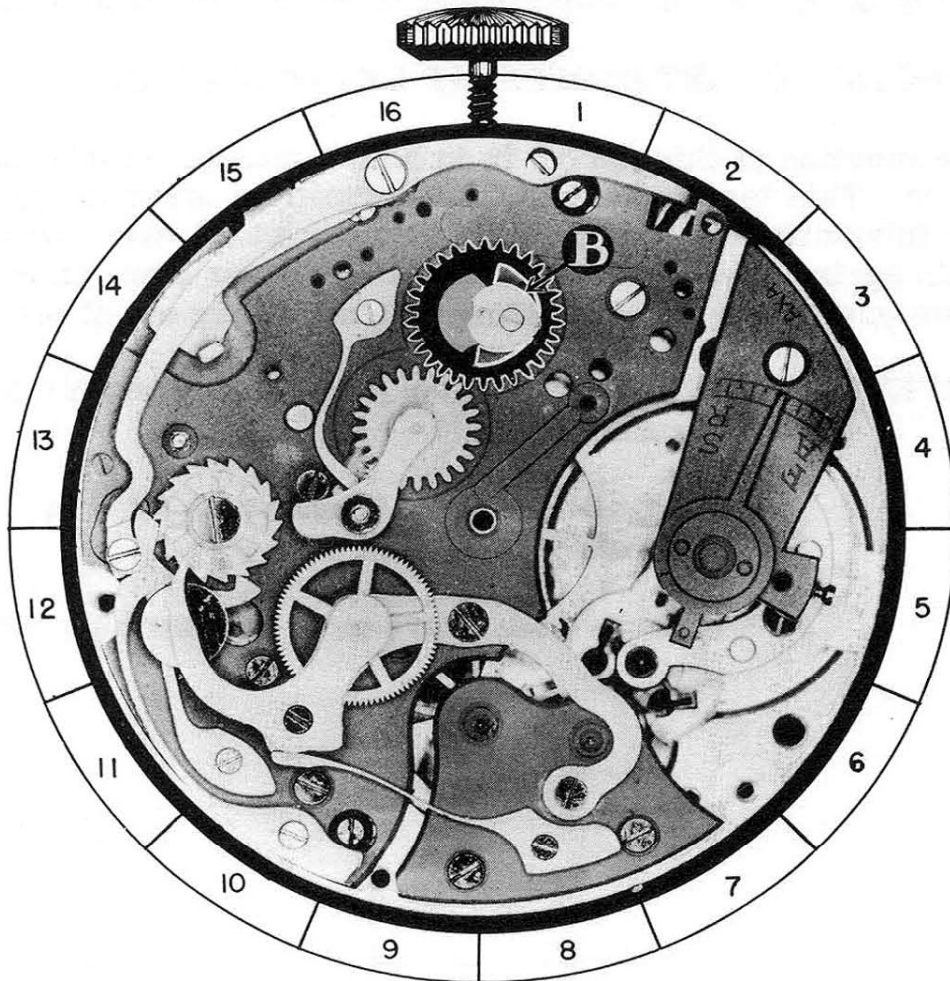

24-A

A. DISASSEMBLY PROCEDURE OF INTERMITTENT LEVER SPRING:

This spring is held in place by beveled countersink screw BS-7 and steady pins. Remove screw and loosen spring from plate by sliding a thin blade screwdriver under spring. When steady pins are free in plate, spring may be lifted out of place.

(The shape of screw for this part is shown at bottom of page.)

B. ASSEMBLY PROCEDURE OF INTERMITTENT LEVER SPRING:

Place spring in its proper position on the plate with steady pins over proper holes in plate. Now press spring down flush on plate, and replace beveled countersink screw BS-7. When replacing this spring, make sure that end "A" of spring sets on top of lip "A" on intermittent lever and wheel assembly.

C. FUNCTION OF INTERMITTENT LEVER SPRING:

The function of this spring is to hold a tension on intermittent lever. This tension forces the intermittent lever to engage the intermittent wheel with the seconds wheel dart tooth. This spring also holds the intermittent lever down on post on plate, preventing it from riding up and coming out of place.

REFERENCE: Intermittent lever and wheel assembly is Assembly 26.

Intermittent wheel is shown as "B" in Assembly 26.

Seconds wheel dart tooth is Assembly 22C.

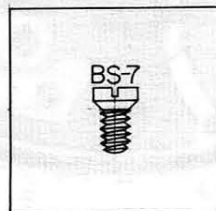

**Intermittent Lever Spring
Assembly No. 25**

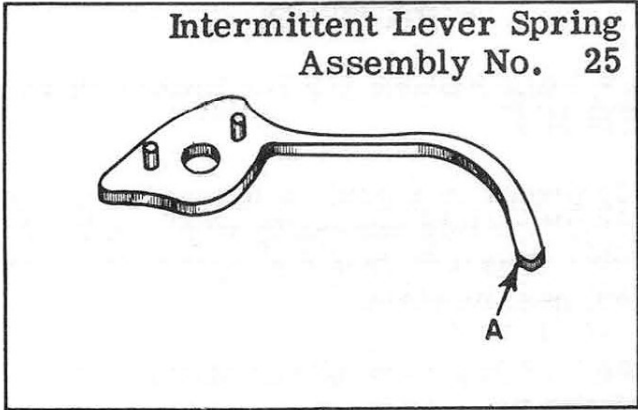

OILING

End "A" of intermittent lever spring should be slightly moistened with oil at point of contact with intermittent lever.

TRAIN SIDE

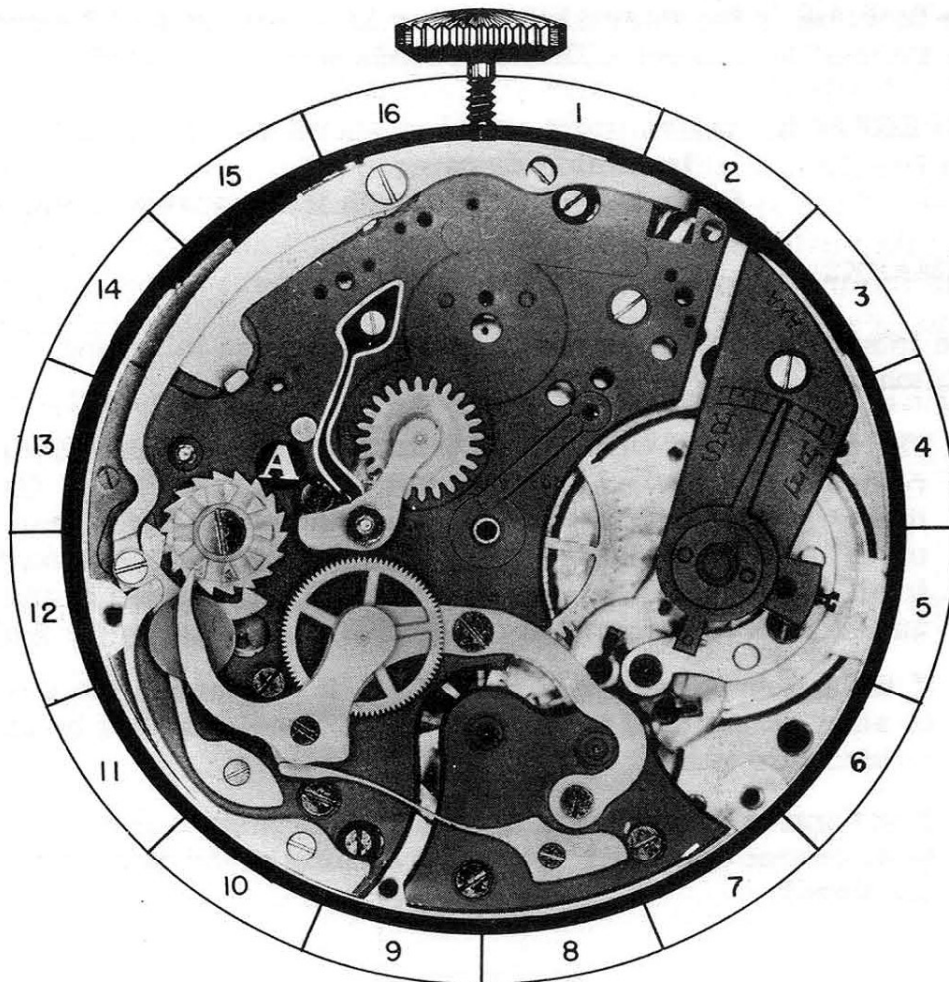

25-A

A. DISASSEMBLY PROCEDURE OF INTERMITTENT LEVER AND WHEEL ASSEMBLY:

This assembly pivots on a post on the plate. To remove it, grip bushing "C" on this assembly with a pair of tweezers and lift straight up. This will free the intermittent lever and wheel assembly from post on plate.

B. ASSEMBLY PROCEDURE OF INTERMITTENT LEVER AND WHEEL ASSEMBLY:

Place hole in bushing in intermittent lever over proper post on plate, as shown in photograph. Now press assembly down on post to proper place. Check this assembly to see that it pivots freely on this post.

C. FUNCTION OF INTERMITTENT LEVER AND WHEEL ASSEMBLY:

The function of the intermittent lever is to engage and disengage the intermittent wheel with the seconds wheel dart tooth.

REFERENCE: Intermittent wheel is shown as "B" in the isometric drawing.
Seconds wheel dart tooth is Assembly 22-C.

REMARKS:

The intermittent wheel must turn freely for the following reasons:

1. The intermittent wheel must rotate slightly on the minute register wheel, when engaging with the seconds wheel dart tooth. If the intermittent wheel is binding, it cannot rotate on the minute register wheel, so when engaging with dart tooth, it moves the minute register wheel forward, causing an incorrect registration of the chronograph.
2. If the intermittent wheel is binding, it may cause the watch to stop, as the dart tooth on seconds wheel may not be able to turn this wheel.
3. If the intermittent wheel is binding, the minute register pawl cannot correctly space the turning of the minute register wheel.

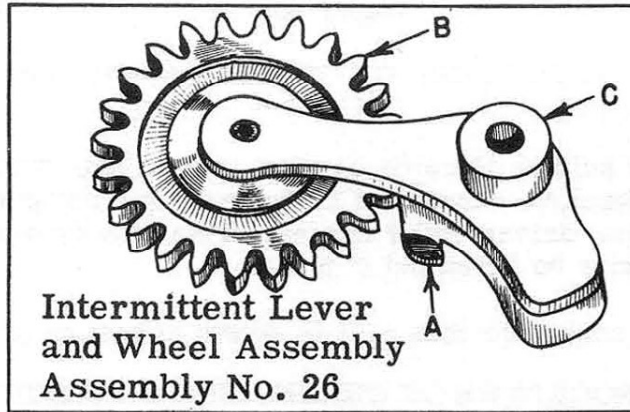

OILING

The post on which the intermittent lever and wheel assembly pivots should be slightly moistened with oil.

TRAIN SIDE

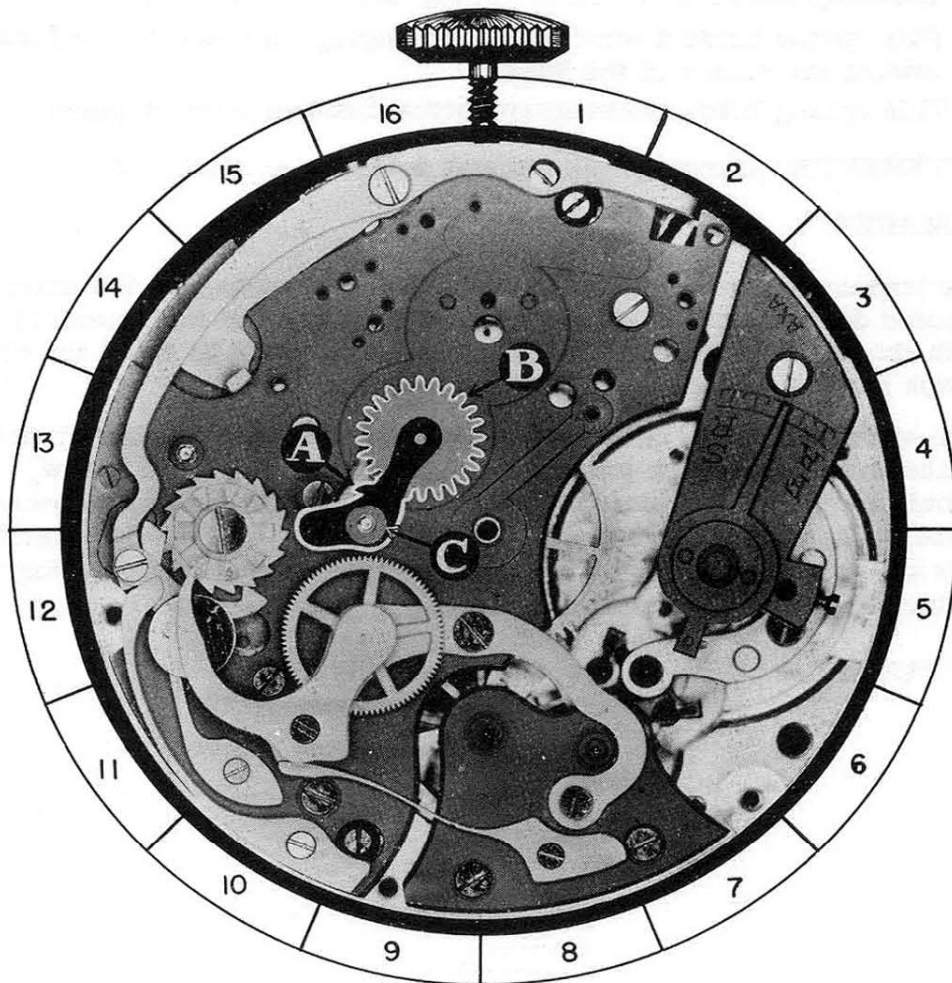

26-A

A. DISASSEMBLY PROCEDURE OF CHRONOGRAPH PIVOTED DETENT SPRING:

This spring is held in place by beveled countersink screw BS-8 and steady pins. Remove screw and loosen spring from plate by sliding a thin blade screw-driver under spring. When steady pins are free in plate, spring may be lifted out of place.

(The shape of screw for this part is shown at bottom of page.)

B. ASSEMBLY PROCEDURE OF CHRONOGRAPH PIVOTED DETENT SPRING:

Place spring on plate in its proper position, with steady pins in proper holes in plate. Now press spring down to proper place, and replace beveled countersink screw BS-8 that holds this spring in place. When replacing this spring, make sure that end "A" of spring fits on top of lip "B" on chronograph pivoted detent.

C. FUNCTION OF CHRONOGRAPH PIVOTED DETENT SPRING:

The chronograph pivoted detent spring has two functions:

1. This spring holds a tension on chronograph pivoted detent forcing it toward the center of the watch.
2. This spring holds chronograph pivoted detent down in place.

REFERENCE: Chronograph pivoted detent is Assembly 30.

REMARKS:

The tension of the chronograph pivoted detent spring on the chronograph pivoted detent must be strong enough to engage the intermediary wheel with the seconds wheel. Any excess tension tends to make the chronograph mechanism harder to work manually.

The endshake of the intermediary wheel, plus the freedom or endshake the chronograph pivoted detent has under head of screw, should not permit the intermediary wheel to rise above the seconds wheel. This condition should be carefully checked, or the intermediary wheel may drop below the seconds wheel, when the chronograph is turned to a dial up position.

REFERENCE: Seconds wheel is Assembly 22.
Intermediary wheel is Assembly 29.

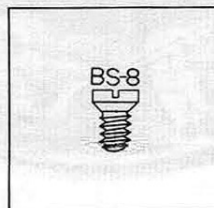

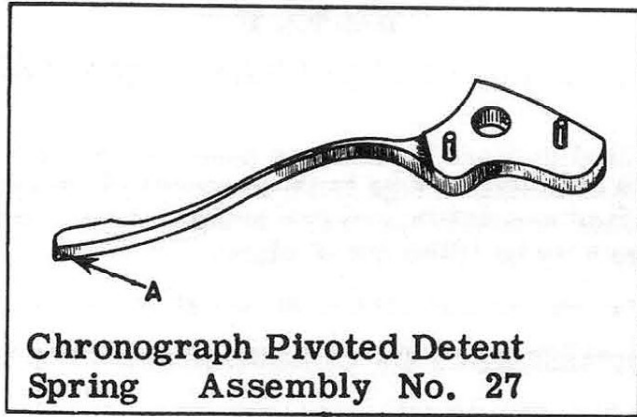

OILING

End "A" of chronograph pivoted detent spring should be slightly moistened with oil at point of contact with chronograph pivoted detent.

TRAIN SIDE

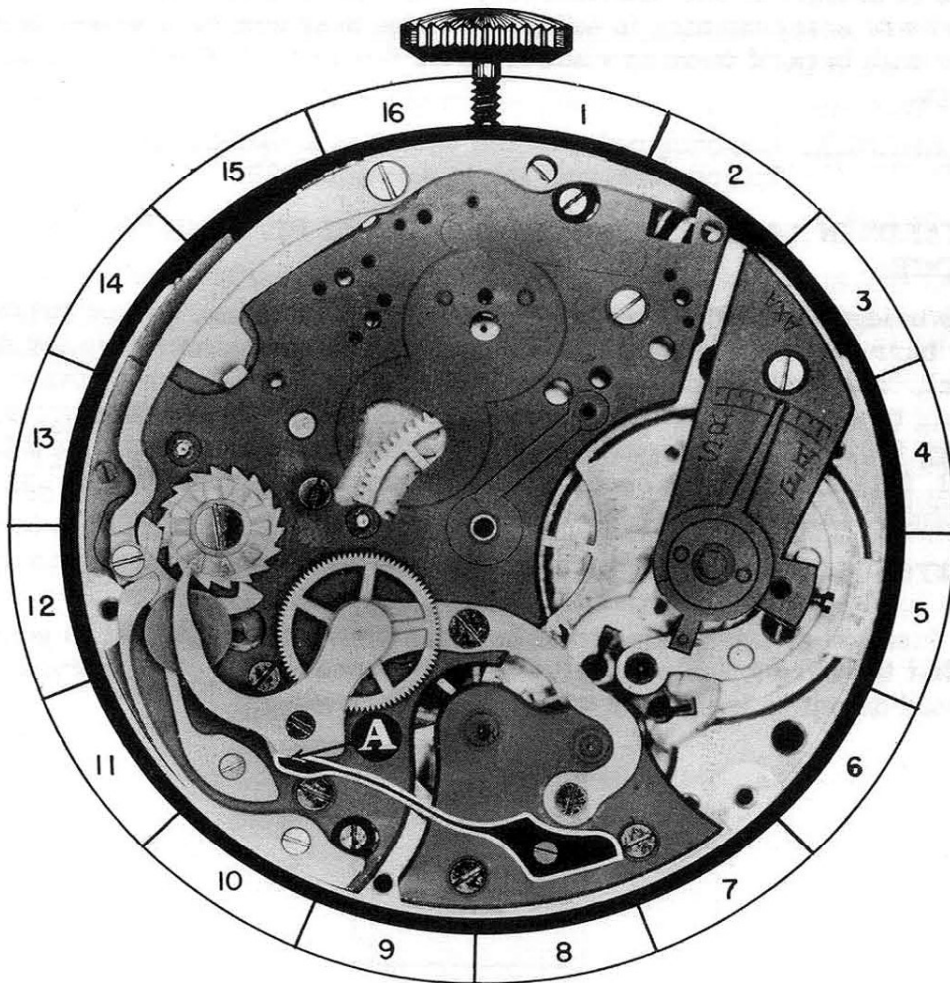

27-A

A. DISASSEMBLY PROCEDURE OF CHRONOGRAPH PIVOTED DETENT BRIDGE:

This bridge is held in place by fillister head screw FS-9 and steady pins. Remove screw, and loosen bridge from chronograph pivoted detent by sliding a thin blade screwdriver under bridge. When steady pins are free in detent, bridge may be lifted out of place.

(The shape of screw for this part is shown at bottom of page.)

B. HAZARDS IN DISASSEMBLY OF CHRONOGRAPH PIVOTED DETENT BRIDGE:

When using a screwdriver to loosen bridge from detent, care should be taken to keep bridge level, as any twisting may damage pivots on intermediary wheel or burr the bushing in bridge or pivoted detent. The screwdriver should be carefully used to prevent marring the bridge or detent.

C. ASSEMBLY PROCEDURE OF CHRONOGRAPH PIVOTED DETENT BRIDGE:

Place bridge on chronograph pivoted detent with steady pins over proper holes in detent. Place intermediary wheel so that the pivots on this wheel will enter bushing in bridge. Bridge may now be pressed to proper place with back of tweezers and fillister head screw FS-9 replaced in bridge.

REFERENCE: Chronograph pivoted detent is Assembly 30.
Intermediary wheel is Assembly 29.

D. HAZARDS IN ASSEMBLY OF CHRONOGRAPH PIVOTED DETENT BRIDGE:

Keep bridge level when pressing down to proper place, as any twisting may burr the bushing in bridge or damage the pivots on intermediary wheel. The bridge and detent, where these two parts come together, should be checked to see that there are no burrs which would prevent bridge from setting properly on chronograph pivoted detent. At this point, it is advisable to check intermediary wheel to see that it has proper endshake. Also check to see that it spins freely.

E. FUNCTION OF CHRONOGRAPH PIVOTED DETENT BRIDGE:

The function of this bridge is to hold the intermediary wheel in position, so that it can function properly. Also it connects the chronograph pivoted detent to the castle wheel.

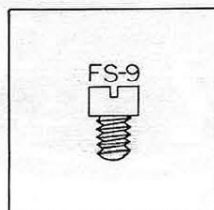

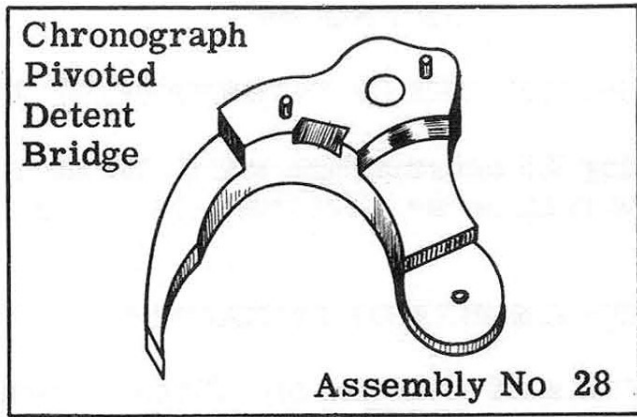

OILING

The pivot in bushing in chronograph pivoted detent bridge should be oiled, as you usually oil a train pivot in a watch.

TRAIN SIDE

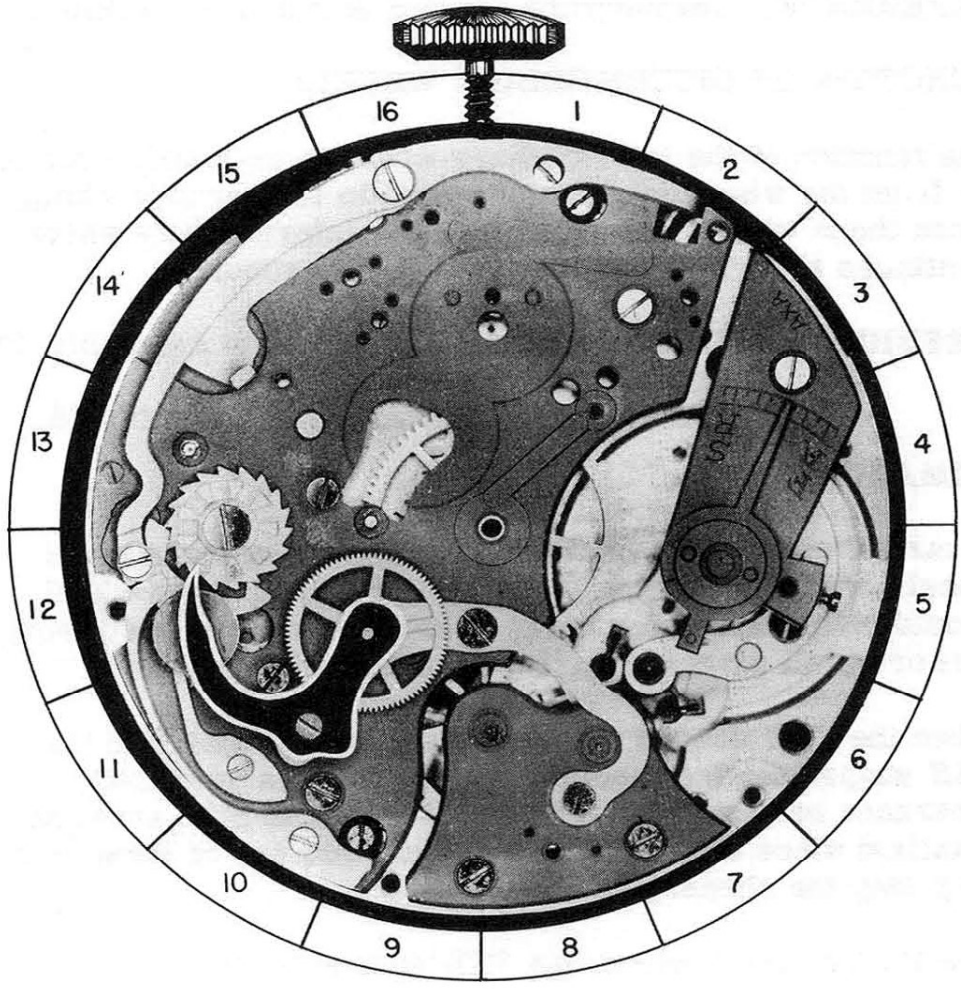

28-A

A. ASSEMBLY PROCEDURE OF INTERMEDIARY WHEEL:

When removing the intermediary wheel, lift the wheel straight up to remove the pivot from chronograph pivoted detent.

B. ASSEMBLY PROCEDURE OF INTERMEDIARY WHEEL:

The end "A" of staff should be up. Place the bottom pivot "B" of staff in hole in bushing of chronograph pivoted detent.

C. HAZARDS IN ASSEMBLY OF INTERMEDIARY WHEEL:

Pivot hole in bushing in chronograph pivoted detent should be carefully examined before replacing intermediary wheel. Any imperfections here will affect the timekeeping of the watch and hinder the proper operation of the chronograph.

REFERENCE: Chronograph pivoted detent is Assembly 5.

D. FUNCTION OF INTERMEDIARY WHEEL:

The function of the intermediary wheel is, to transfer the power from the wheel over fourth wheel to the seconds wheel, when these wheels are engaged. The intermediary wheel continues to turn, as long as the watch is running.

REFERENCE: Chronograph pivoted detent is Assembly 30.
Seconds wheel is Assembly 22.
Wheel over fourth wheel is Assembly 15.

REMARKS:

A careful and detailed examination should be made of all wheels, before replacing in the chronograph. Each wheel should be examined for burred pivots, bent or burred teeth, dirt or small pieces of grit wedged between the teeth.

When the VEE shaped teeth of one wheel meshes into the VEE shaped teeth of another wheel, there is very little clearance between the teeth, and because of this, even the smallest piece of grit or dirt wedged into one of these teeth may stop the chronograph.

The intermediary wheel has VEE shaped teeth.

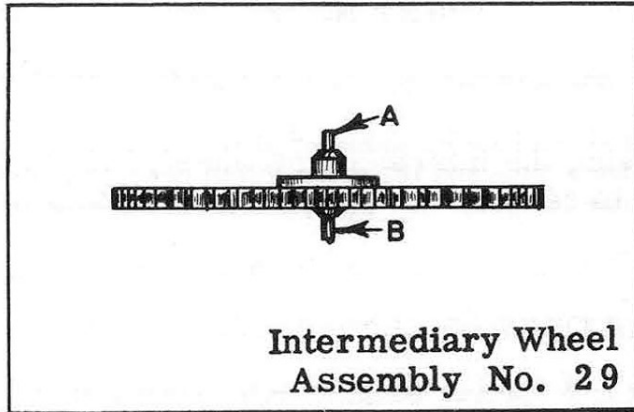

OILING

The bottom pivot on intermediary wheel should be oiled before placing pivot in chronograph pivoted detent. The top pivot is oiled after bridge for this wheel is placed in chronograph pivoted detent.

TRAIN SIDE

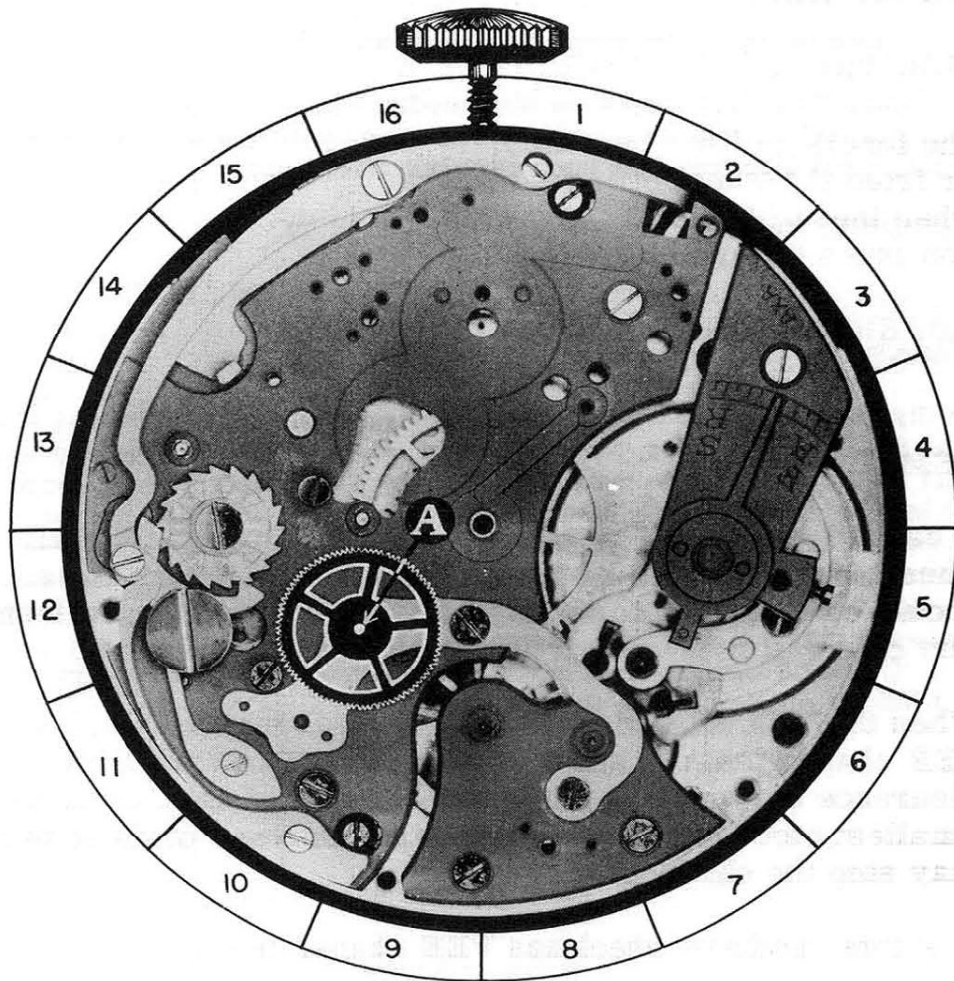

29-A

A. DISASSEMBLY PROCEDURE OF CHRONOGRAPH PIVOTED DETENT:

This detent is held in place by shouldered screw SS-9 and pivots on an eccentric stud. Remove screw, and lift detent from eccentric stud, lifting it straight up, to free the post "A" on detent from the hole in the plate.

(The shape of screw for this part is shown at bottom of page.)

B. ASSEMBLY PROCEDURE OF CHRONOGRAPH PIVOTED DETENT:

Place the detent in its proper position on the plate, with the post "A" of detent down in proper hole in plate. Also make sure that the hole in end of detent fits over the eccentric stud. When detent is in place, replace shouldered screw SS-9 that holds this detent in place. Detent must move freely under the head of this screw.

C. HAZARDS IN ASSEMBLY OF CHRONOGRAPH PIVOTED DETENT:

After replacing detent, check to see that it moves freely under the head of shouldered screw SS-9, and yet, does not have excess freedom.

D. FUNCTION OF CHRONOGRAPH PIVOTED DETENT:

The functions of the chronograph pivoted detent are:

1. It engages and disengages the intermediary wheel with the seconds wheel.
2. The pin "A" of this lever controls the hour yoke connecting lever to engage and disengage the hour register mechanism.

REFERENCE: Intermediary wheel is Assembly 29.
Seconds wheel is Assembly 22.
Hour yoke connecting lever is Assembly 10.

REMARKS:

When disassembling the chronograph, each part should be carefully examined as it is removed from the movement. Each part should be checked against the isometric drawing to see that the part is the correct shape and is not broken. Each part should also be checked for any pits of rust, roughness, burrs, or worn parts which may cause the part not to work properly. The replacement of the defective part in the chronograph may necessitate the complete disassembly of the chronograph. Through a close examination of each part you will soon become familiar with the parts in a chronograph. This will enable you to quickly recognize the defective part and repair it before replacing it in the chronograph.

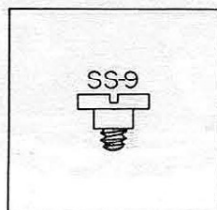

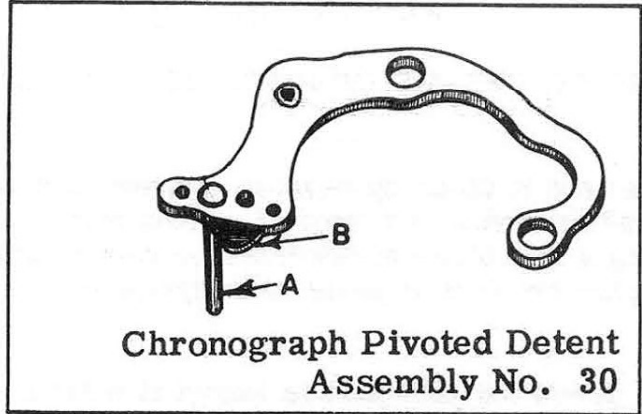

Chronograph Pivoted Detent
Assembly No. 30

OILING

The eccentric stud on which the chronograph pivoted detent pivots should be slightly moistened with oil.

TRAIN SIDE



30-A

A. DISASSEMBLY PROCEDURE OF ACTUATING DETENT LEVER SPRING:

This spring is held in place by beveled countersink screw BS-9 and steady pins. After screw is removed, spring may be loosened from plate by sliding a thin blade screwdriver between spring and plate. When steady pins are free in plate, this spring can be lifted out of place.

(The shape of screw for this part is shown at bottom of page.)

B. ASSEMBLY PROCEDURE OF ACTUATING DETENT LEVER SPRING:

Place this spring in its proper position, as shown in the photograph, with steady pins on spring entering the proper holes in plate. The shoulder "A" of spring should contact side of joint hook. Now press spring down with back of tweezers, and replace beveled countersink screw BS-9 that holds this spring in place.

C. FUNCTION OF ACTUATING DETENT LEVER SPRING:

The functions of this spring are as follows:

1. It holds the joint hook, in toward the center of watch.
2. It holds a tension on the joint hook, holding it engaged with the ratchet teeth on the castle wheel.
3. It helps hold joint hook down flush on plate.

REMARKS:

The end "A" of actuating detent is sometimes hard to depress causing the chronograph to be harder to work by the operator. A combination of one or more of the following reasons can cause this:

1. The actuating detent lever spring holding too strong a tension on actuating detent.
2. The castle wheel pawl holding too strong a tension on castle wheel.
3. Improper oiling of the castle wheel.

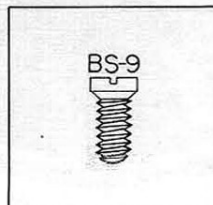

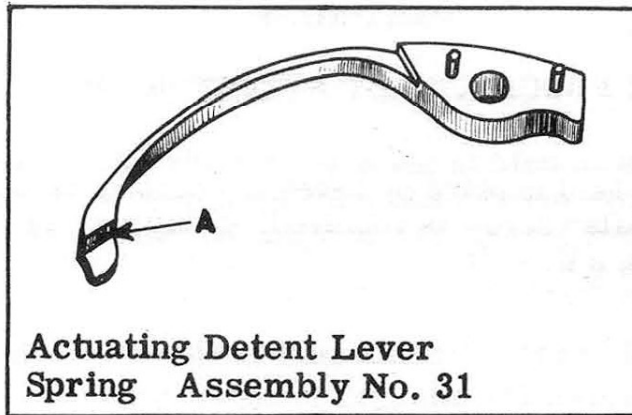

OILING

End "A" of actuating detent lever spring should be slightly moistened with oil at point of contact with joint hook.

TRAIN SIDE

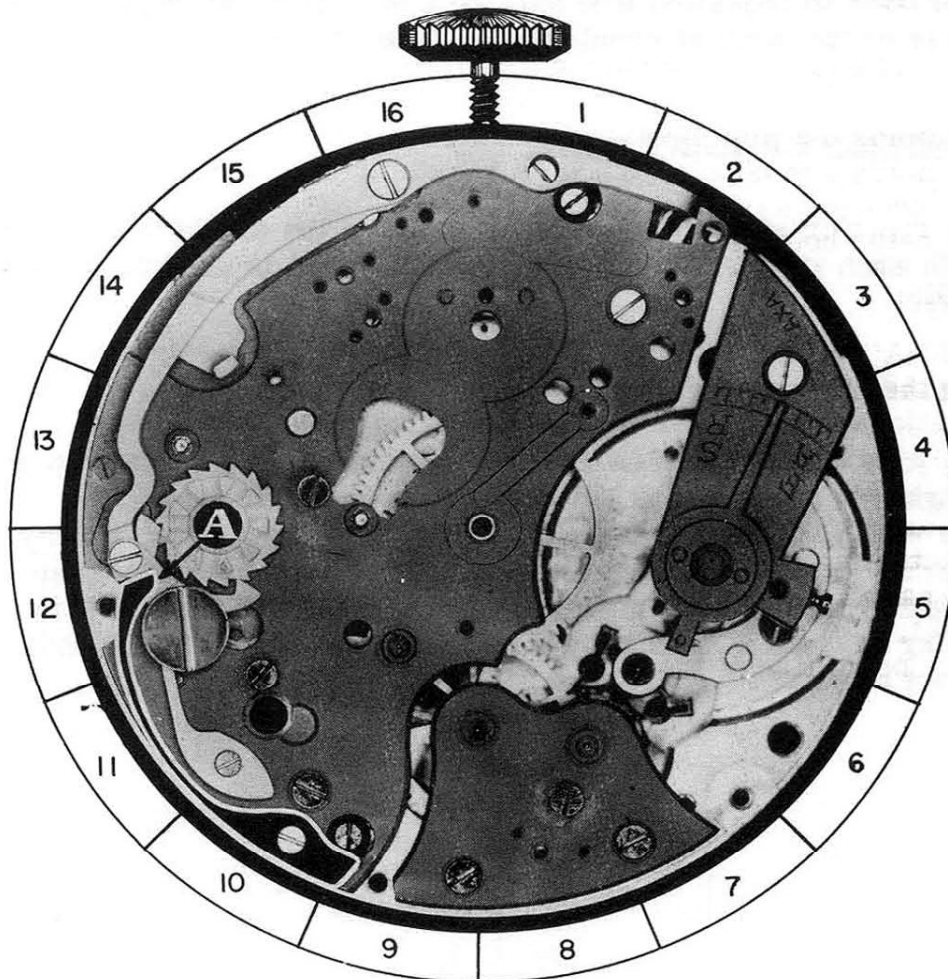

31-A

A. DISASSEMBLY PROCEDURE OF JOINT HOOK:

The joint hook is held in place by shouldered screws SS-10 and SS-11. Remove screws, and joint hook may be lifted from actuating detent lever. The position of these screws is shown in the photograph.

(The shape of screws for this part is shown at bottom of page.)

B. ASSEMBLY PROCEDURE OF JOINT HOOK:

Place the joint hook in position on end "B" of actuating detent lever. The hole in joint hook should be placed over hole in end of actuating detent lever; also end "A" of joint hook should be in contact with the ratchet teeth on castle wheel. Now replace shouldered screw SS-10 that holds the joint hook to the actuating detent lever. After this screw is replaced, replace shouldered screw SS-11 that holds the joint hook down and in position. After joint hook is replaced, it should be checked to see that it moves freely under head of shouldered screw SS-10.

C. FUNCTION OF JOINT HOOK:

The function of the joint hook is to move the castle wheel one tooth each time end "A" of actuating detent is pushed manually.

REMARKS:

The joint hook should be carefully examined for any burrs or roughness, as this may cause it not to function properly. The end "A" of joint hook should be highly polished, as any burrs or roughness may cause the joint hook not to engage properly with the ratchet teeth on castle wheel. When polishing this part, care should be taken that the shape of hook is not changed.

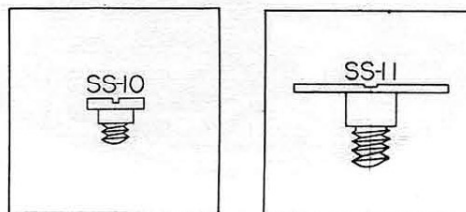

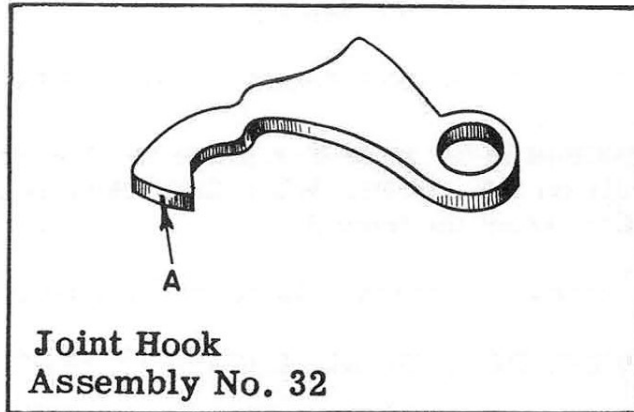

OILING

The shoulder of screw, on which joint hook pivots, should be slightly moistened with oil.

TRAIN SIDE

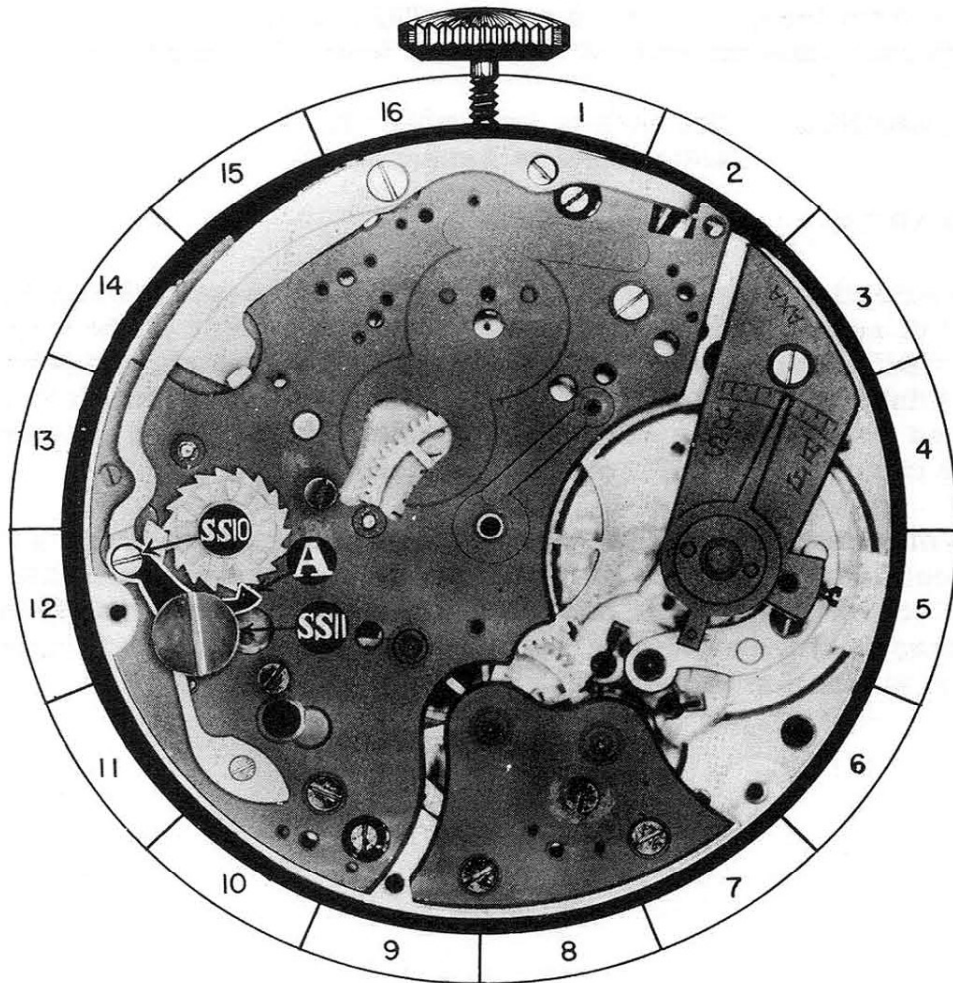

A. DISASSEMBLY PROCEDURE OF ACTUATING DETENT LEVER:

The actuating detent lever is held in place by shouldered screw SS-12 and pivots on this screw. When this screw is removed, detent may be lifted from movement.

(The shape of screw for this part is shown at bottom of page.)

B. ASSEMBLY PROCEDURE OF ACTUATING DETENT LEVER:

Place actuating detent lever in its proper position on the plate, as shown in photograph. When actuating detent lever is in its proper position, replace shouldered screw SS-12 that holds this detent lever in place. After screw is replaced, the actuating detent lever should be checked to see that it pivots freely under the head of this screw.

C. FUNCTION OF ACTUATING DETENT LEVER:

The function of the actuating detent lever is to move the joint hook away from the center of the watch. This turns the castle wheel one tooth, each time the end "A" of detent lever is pushed.

REFERENCE: Joint hook is Assembly 32.
Castle wheel is Assembly 36.

REMARKS:

The actuating detent works somewhat like a see-saw. When end "A" of actuating detent is forced toward the center of the watch, end "B" is forced away from the center of the watch, and because the joint hook is attached to end "B" of actuating detent, it is also forced away from the center of the watch, naturally, at the same time causing the castle wheel to turn one tooth.

The movement of the end "A" of the actuating detent lever toward the outside of the watch is limited by a stop screw in the plate. This stop screw prevents the end "A" of actuating detent lever from moving any further toward the outside of the watch than is necessary for it to function properly.

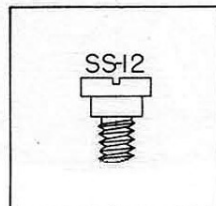

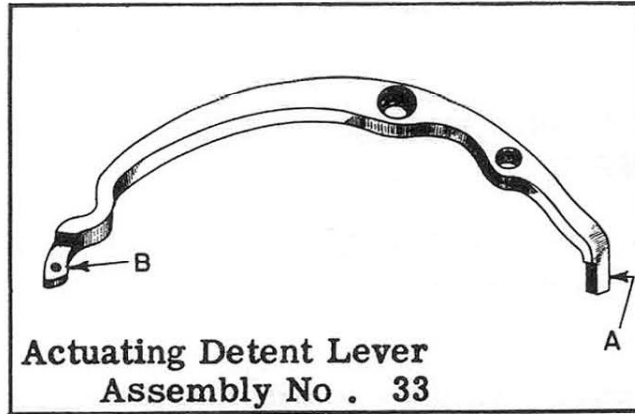

Actuating Detent Lever
Assembly No . 33

OILING

The shoulder of screw on which actuating detent lever pivots should be slightly moistened with oil.

TRAIN SIDE

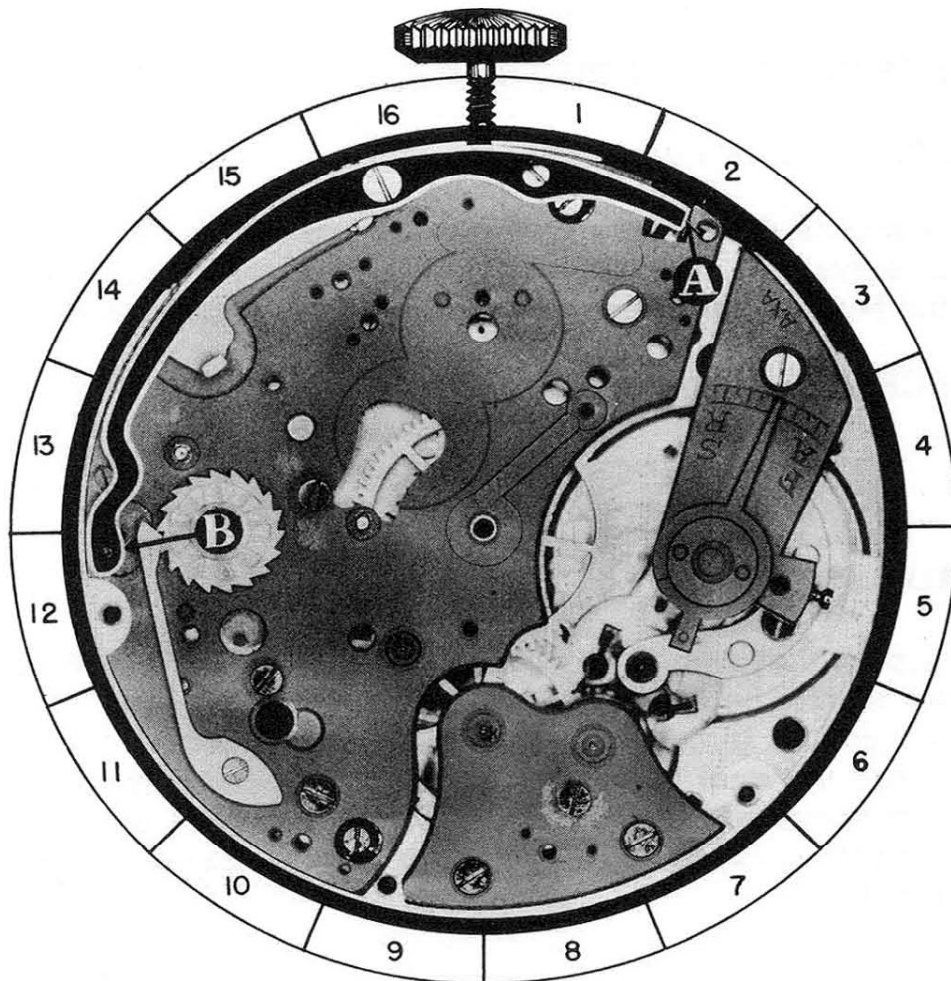

33-A

A. DISASSEMBLY PROCEDURE OF PUSH PIECE FOR SETTING BACK TO ZERO:

The push piece for setting back to zero pivots on a hollow stud in plate. To remove this piece, simply lift it straight up.

B. ASSEMBLY PROCEDURE OF PUSH PIECE FOR SETTING BACK TO ZERO:

Place hole in push piece for setting back to zero over hollow stud on plate. The end "A" of push piece is placed down, while the end "B" will be up. This push piece is held in place by the actuating detent lever.

REFERENCE: Actuating detent lever is Assembly 33.

C. FUNCTION OF PUSH PIECE FOR SETTING BACK TO ZERO:

The functions of this push piece, when pushed, are as follows:

1. It moves the flyback lever in toward the center of the watch.
2. It moves the hour flyback push piece, which in turn moves the hour flyback lever in toward the center of the watch.

REFERENCE: Hour flyback push piece is Assembly 3.
Hour flyback lever is Assembly 5.
Flyback lever is Assembly 18.

REMARKS:

Each part that should move under the head of a shouldered screw should be checked for the required freedom. Any excess freedom is not desired. In the case where a part has too much vertical movement or endshake under the head of a shouldered screw, the shoulder on the screw is too long. To correct this, cut back the shoulder on the screw, reducing the length of it.

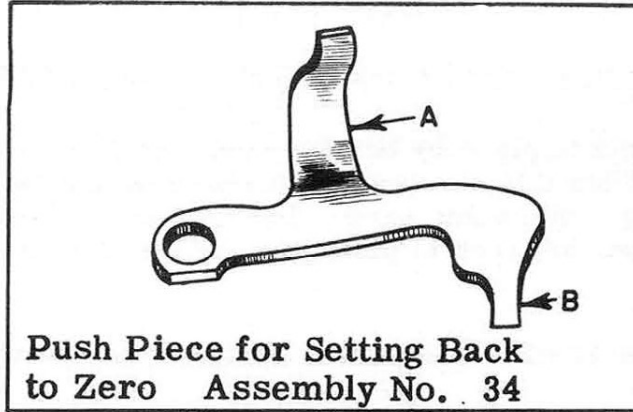

OILING

The post on which push piece for setting back to zero pivots should be slightly moistened with oil.

TRAIN SIDE

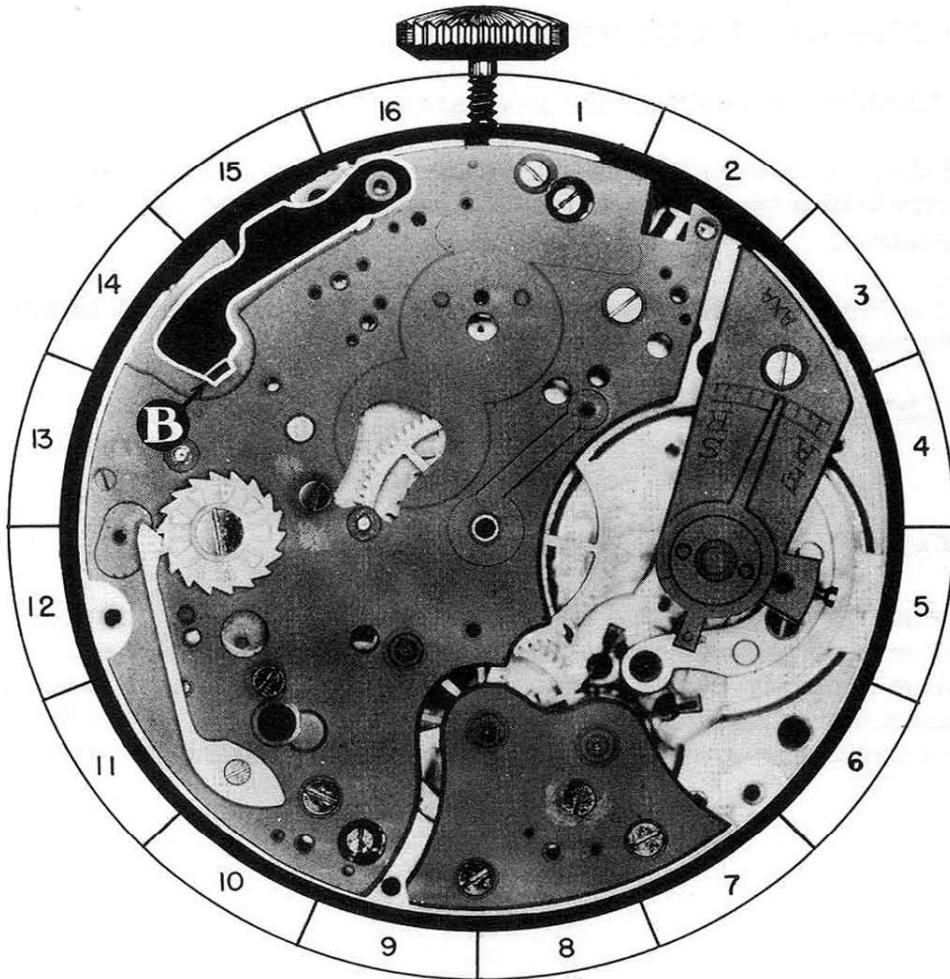

34-A

A. DISASSEMBLY PROCEDURE OF CASTLE WHEEL PAWL:

This pawl is held in place by beveled countersink screw BS-10 and steady pins. When this screw is removed, pawl can be lifted from plate by sliding a thin blade screw-driver between pawl and plate. After steady pins are free in plate, the pawl may be lifted out of place.

(The shape of screw for this part is shown at the bottom of page.)

B. ASSEMBLY PROCEDURE OF CASTLE WHEEL PAWL:

Place the pawl in its proper position on plate, with steady pins in holes in plate. Now press the pawl down in proper position on plate. Make sure that end "A" of pawl is not on top of the ratchet teeth on the castle wheel, but meshing in between two teeth on this wheel. Now replace beveled countersink screw BS-10 that holds this pawl in place.

REFERENCE: Castle wheel is Assembly 36.

C. FUNCTION OF CASTLE WHEEL PAWL:

The functions of castle wheel pawl are:

1. This pawl correctly spaces the turning of the castle wheel. This eliminates the possibility of the castle wheel setting at an incorrect position.
2. It holds the castle wheel in its correct position until it is moved manually.

REFERENCE: Castle wheel is Assembly 36.

The ratchet teeth on castle wheel are shown as "B" on the isometric drawing.

REMARKS:

The end "A" of the castle wheel pawl should be highly polished. Any roughness or pits of rust at this location may cause the pawl not to function properly. If it is necessary to polish this part, care should be taken not to change the shape of end "A" of pawl. It must be of correct shape to properly space the turning of the castle wheel.

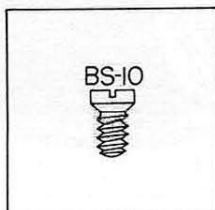

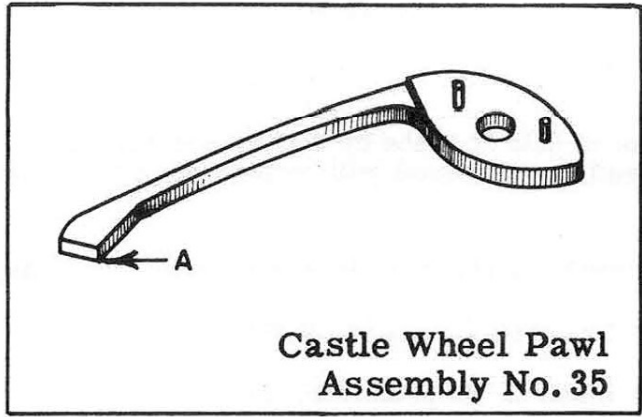

OILING

The castle wheel pawl should not be oiled.

TRAIN SIDE

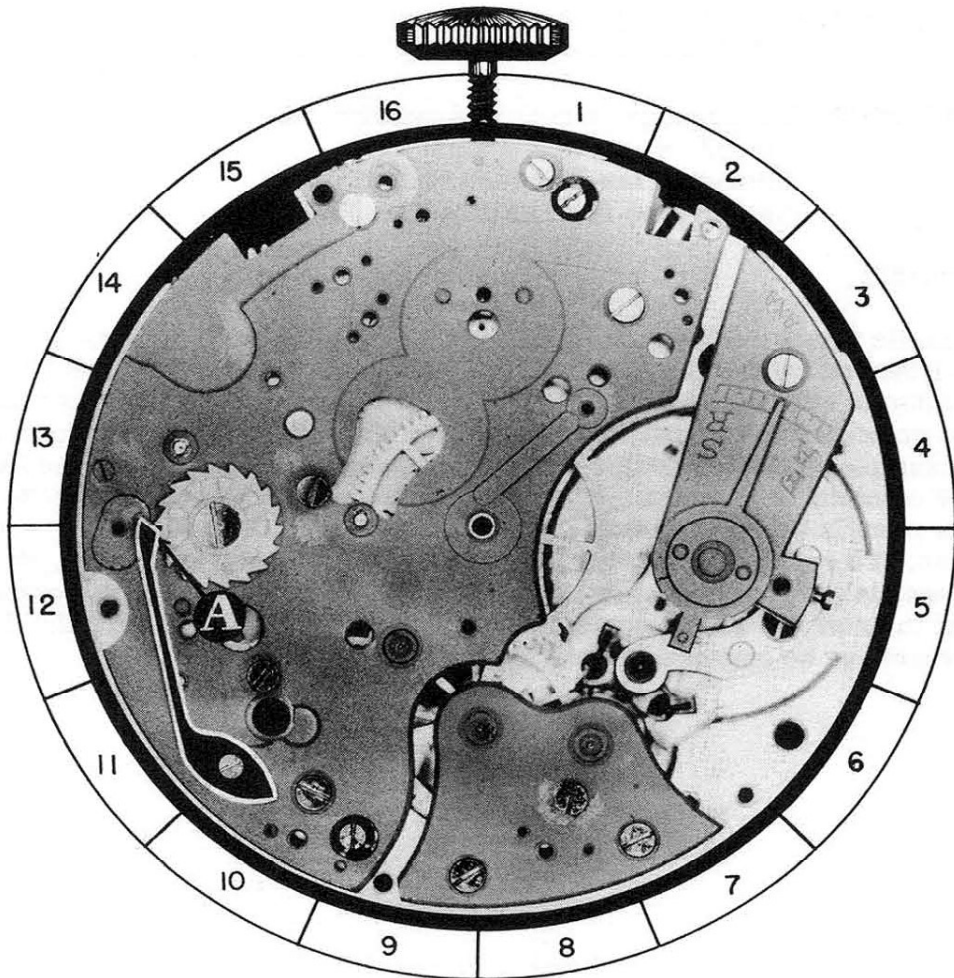

35-A

A. DISASSEMBLY PROCEDURE OF CASTLE WHEEL:

The castle wheel is held in place by shouldered screw SS-13. After this screw is removed, castle wheel will be free on plate and can be lifted out of place.

(The shape of screw for this part is shown at bottom of page.)

B. ASSEMBLY PROCEDURE OF CASTLE WHEEL:

Place the castle wheel in its proper position on the plate, as shown in the photograph. Replace shouldered screw SS-13 that holds this wheel in place. Check to see that wheel turns freely under the head of this screw. Of course, this wheel should not have excess freedom, as such a condition could cause improper functioning of the chronograph.

C. FUNCTION OF CASTLE WHEEL:

The functions of the castle wheel are:

1. It disengages the intermediary wheel from the seconds wheel.
2. It disengages the brake lever from the seconds wheel.
3. It prevents the flyback lever from being moved toward the center of the watch, when the chronograph mechanism is engaged.

REFERENCE: Intermediary wheel is Assembly 29.
Seconds wheel is Assembly 22.
Flyback lever is Assembly 18.
Brake lever is Assembly 19.

REMARKS:

The castle wheel performs its functions by the columns "A" which are evenly spaced around the center of the wheel. As the castle wheel is turned, the columns either force the part to move out from the center of the castle wheel or permit it to move in to the empty space between the two columns. For example, the intermediary wheel is disengaged from the seconds wheel by the columns of the castle wheel forcing the end of chronograph pivoted detent from between the columns until the point of this lever rests on the column. To engage the intermediary wheel with the seconds wheel, the castle wheel is turned one space. This permits end of chronograph pivoted detent to enter the empty space between the columns which permits the two wheels to be engaged by the chronograph pivoted detent.

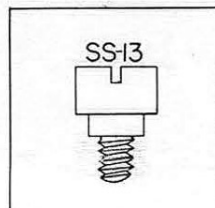

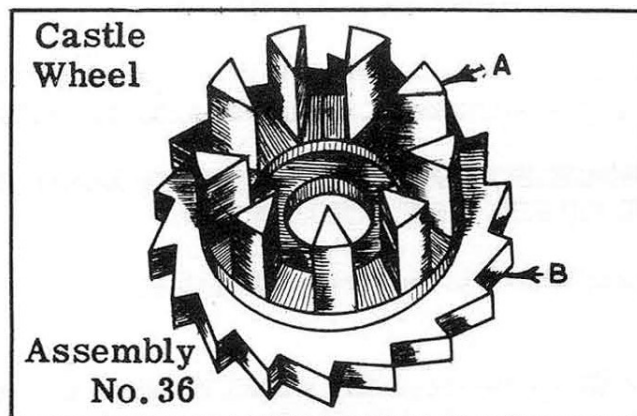

OILING

- Slightly moisten the castle wheel with oil at these points:
1. The shoulder of screw on which castle wheel pivots.
 2. The columns "A" that contact parts of this mechanism.
 3. The castle wheel ratchet teeth "B".

TRAIN SIDE

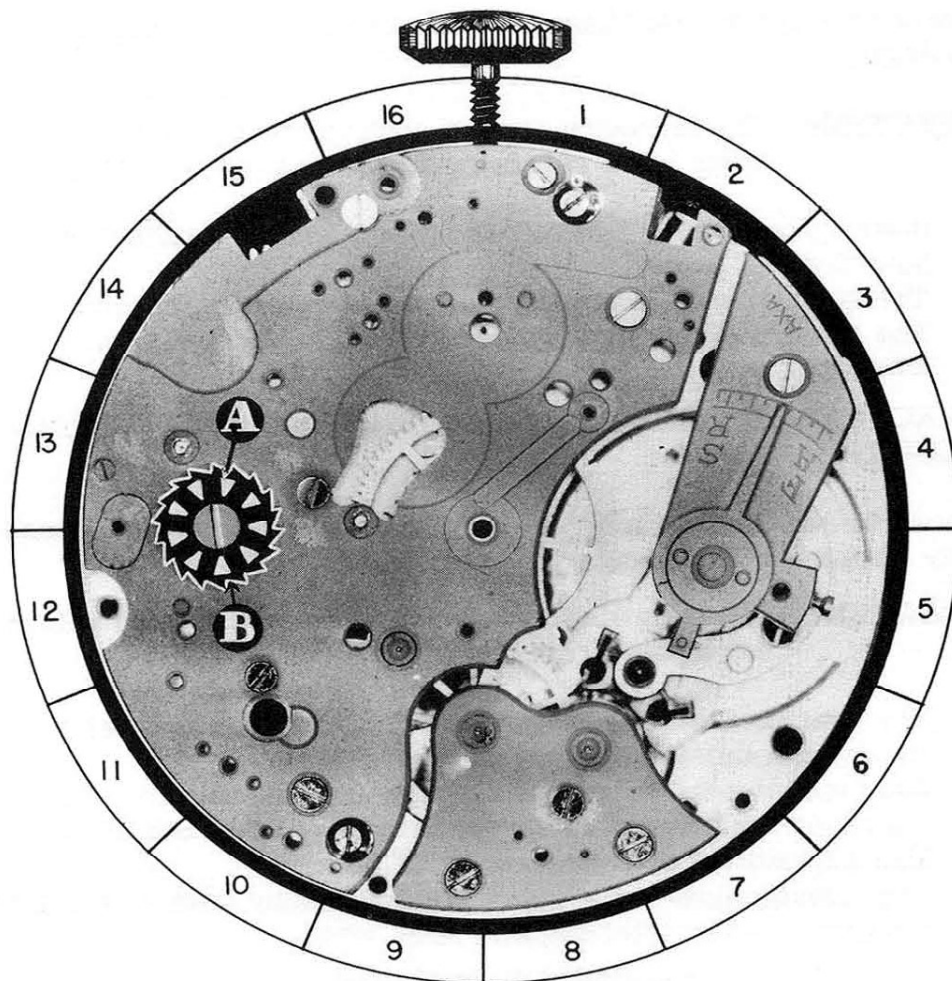

36-A

FUNCTIONAL RESULTS

After chronograph movement is completely assembled with exception of dial and hands, place movement in holder with dial side facing you.

1. PRESS PUSH PIECE FOR SETTING BACK TO ZERO, HOLD IN THIS POSITION, AND CHECK THE FOLLOWING:

(Make sure castle wheel is in proper position, so push piece can be pushed.)

- A. Check to see that hour register wheel returns to a zero position.

CORRECTION: The following errors could prevent the hour register wheel from returning to a zero position:

- a. The hour register wheel binding and not turning freely.
- b. Improper adjustment of eccentric stud, ES-3. (See adjustment of eccentric studs.)

2. RELEASE PUSH PIECE AND CHECK THE FOLLOWING:

- A. Check to see that hour flyback lever returns to its original position.

CORRECTION: The following errors could prevent hour flyback lever from returning to its original position:

- a. Hour flyback lever spring not holding enough tension on hour flyback lever.
- b. The hour flyback lever binding and not pivoting freely.
- c. The intermediate hour flyback detent, or the articulation arm binding.

3. PUSH ACTUATING DETENT LEVER, RELEASE IT, AND CHECK THE FOLLOWING:

- A. Check to see that the intermediary hour wheel teeth are properly engaged with the hour register wheel teeth.

CORRECTION: The following errors could cause these wheels not to engage properly:

- a. The hour pivoted detent spring being too weak and not holding enough tension on hour pivoted detent.
- b. The hour pivoted detent binding and not pivoting freely.
- c. Improper adjustment of eccentric studs, ES-1 and ES-2. (See adjustment of eccentric studs.)
- d. The intermediate hour wheel tension spring holding too strong a tension on the intermediate hour wheel.

(Continued on next page.)

FUNCTIONAL RESULTS
(Continued)

4. Now replace the dial and hands, and place the movement in case. Do not replace the back of case at this time. Place the chronograph in front of you, with the pendant up, and the train side facing you. Push the button to the left of the pendant, hold in this position, and check the following:

A. Check to see that seconds wheel and minute register wheel return to a zero position. Also check on dial to see that the hands attached to these wheels return to a zero position.

CORRECTION: The following errors could prevent these wheels or hands from returning to a zero position:

- a. Hands being loose and not set correctly.
- b. The minute register wheel or seconds wheel binding and not turning freely.

B. Check to see that end of minute register pawl is centered between two teeth on the minute register wheel, when this wheel is at a zero position.

CORRECTION: The following errors may prevent the minute register pawl from being centered between two teeth on the minute register wheel:

- a. Minute register wheel binding and not turning freely.
- b. Intermittent wheel binding and not turning freely.
- c. The pawl not holding sufficient tension on the minute register wheel.

5. **RELEASE BUTTON AND CHECK THE FOLLOWING:**

A. Check to see that the flyback lever returns to its original position.

CORRECTION: The following errors could prevent the flyback lever from returning to its original position:

- a. Flyback lever spring not holding enough tension on flyback lever.
- b. Flyback lever binding and not pivoting freely.

6. **PUSH BUTTON AT RIGHT OF PENDANT, RELEASE IT, AND CHECK THE FOLLOWING:**

A. Check depth of intermediary wheel teeth with seconds wheel teeth.

CORRECTION: The following errors could prevent correct depth of these teeth:

(Continued on next page)

FUNCTIONAL RESULTS

(Continued)

- a. Chronograph pivoted detent spring not holding enough tension on chronograph pivoted detent.
- b. Chronograph pivoted detent not pivoting freely.
- c. Improper adjustment of eccentric stud, ES-5. (See adjustment of eccentric studs.)

B. Check depthing of seconds wheel dart tooth with intermittent wheel teeth.

CORRECTION: The following errors could prevent the correct depthing of seconds wheel dart tooth with intermittent wheel teeth:

- a. Intermittent lever not turning freely on post.
- b. Intermittent lever spring not holding enough tension on intermittent lever.
- c. Improper adjustment of eccentric stud, ES-6. (See adjustment of eccentric studs.)

REMARKS: If the depthing of intermittent wheel teeth with the seconds wheel dart tooth is deep, the minute register wheel may move two teeth each time the seconds wheel makes one revolution. If the depthing is shallow, the minute register wheel may not turn far enough, to register a minute on the dial.

C. Check to see that the seconds hand moves forward in a steady manner with no irregular jumping or jerking.

CORRECTION: This irregular movement of seconds hand is usually caused by the seconds wheel tension spring not holding enough tension on seconds wheel:

7. PUSH BUTTON AT RIGHT OF PENDANT A SECOND TIME, RELEASE IT, AND CHECK THE FOLLOWING:

A. Check to see that brake lever is in contact with seconds wheel.

CORRECTION: The following errors may prevent the brake lever from contacting the seconds wheel:

- a. Brake lever not pivoting freely under head of screw.
- b. Brake lever spring not holding enough tension on brake lever.

IDENTIFYING A CHRONOGRAPH OR STOP WATCH

The chronograph and stop watch are very similar in appearance in many respects, but there is a difference which will enable you to distinguish the chronograph from the stop watch.

The chronograph is a watch having at least one supplementary hand in addition to the regular hour, minute, and second hand which can be started, stopped or returned to zero at will. Thus the chronograph can be used as a regular timekeeping watch and may also be used in registering observations.

The stop watch is a watch which has only the necessary hands to register an observation, the hour, minute, and seconds hand being omitted. The stop watch is not used to indicate the time of day, but only to register the length of observations.

The stop watch is divided into two categories, the stop watch in which the balance wheel is continually in motion and the stop watch in which the balance wheel is in motion only during the actual timing of observations.

The advantage in the latter type is that the watch is running only during the actual timing operation. Thus there is less wear to the stop watch and the mainspring does not have to be wound so often. This is especially true in the stop watch which has a very rapid oscillation of the balance. The stop watch by altering the hairspring and balance wheel to increase the oscillation of the balance can be made to register $1/30$, $1/50$, or even $1/100$ of a second. This increase in the oscillation of the balance in the stop watch is possible because the balance wheel is in motion only during the actual timing operation and the watch does not indicate the time of day.

The chronograph is designed to register the time correct to $1/5$ of a second. It would be difficult to make a chronograph register correctly to less than $1/5$ of a second, as the rapid oscillation of the balance would require too large a mainspring to run the watch for a twenty-four hour period, and the hour and minute hand would have to be geared down tremendously to keep the correct time.

The chronograph usually embodies the basic principles by which the stop watch performs its function, and to anyone familiar with the functions of the various parts of a chronograph should have no trouble understanding stop watch mechanism.

THE TACHOMETER

- A. The tachometer is used to indicate the speed of an object in miles per hour. A tachometer can only indicate the average speed of an object traveling over a course of a measured mile.

METHOD OF USING TACHOMETER

1. Start chronograph sweep second hand at the exact moment the object starts to travel the measured distance of one mile.
2. When the object has traveled the course of one mile, stop the chronograph sweep second hand. The point on the tachometer scale where the sweep second hand stopped will indicate the average speed of the object in miles per hour.

SECOND HAND

- B. The second hand indicates the passing of seconds and should move one space each second. One complete revolution of hand denotes passage of one minute. This hand is independent of chronograph mechanism and continues to register the seconds as long as watch is running.

SPLIT SECOND SCALE

- C. This scale is divided into 300 divisions, each indicating $\frac{1}{5}$ of a second. Every fifth division is marked with extra long lines denoting one second.

The main purpose of this scale is to measure a fraction of a second accurately.

MINUTE REGISTER

- D. The minute register hand indicates on the dial the number of minutes that have elapsed since the beginning of the registration of the sweep second hand. One complete revolution of the minute register hand indicates the passage of 30 minutes; two revolutions, one hour.

HOUR REGISTER

- E. The hour register hand indicates on the dial the number of hour that have elapsed since the beginning of the registration of the sweep second hand. Each division on the scale denotes $\frac{1}{2}$ hour. Each number on scale denotes one hour. One complete revolution of hour register hand indicates 12 hours have elapsed. This hand will register the hours as long as the chronograph mechanism is in operation.

THE CHRONOGRAPH DIAL

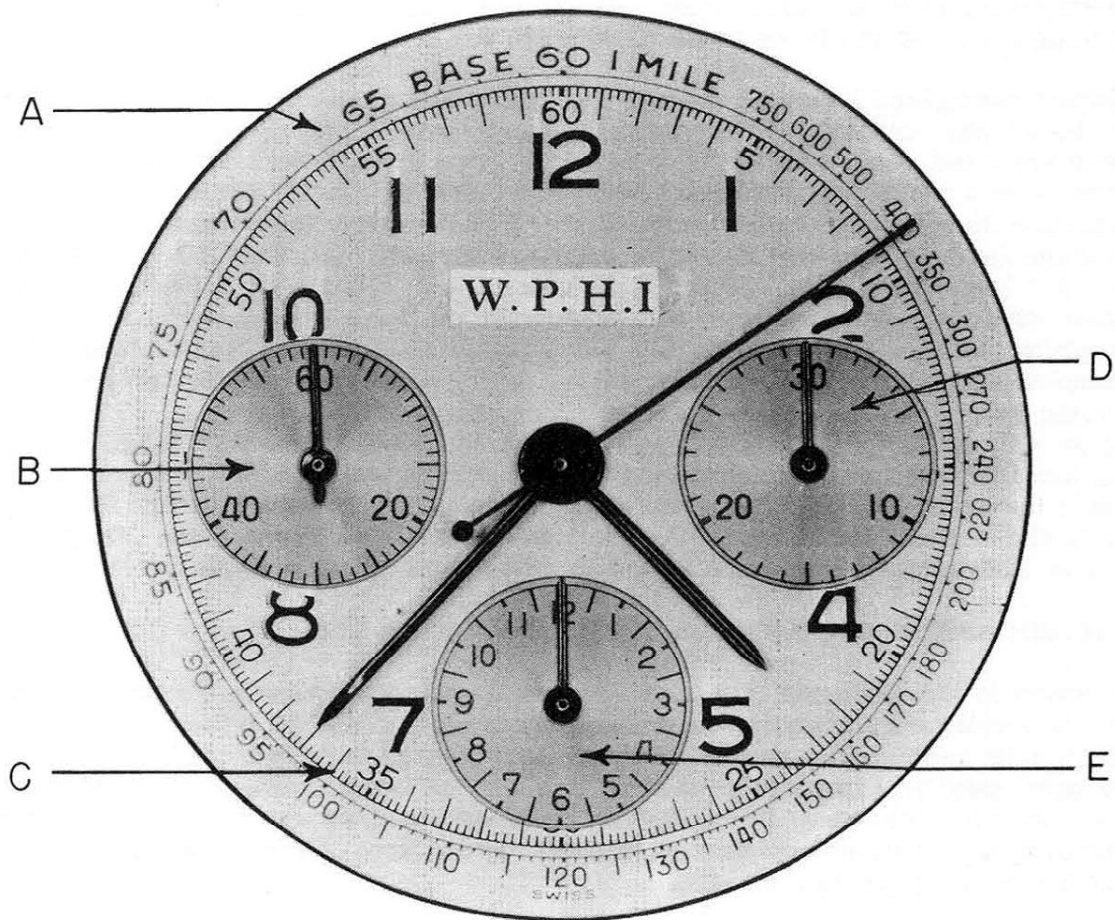

SETTING THE HANDS CORRECTLY ON A CHRONOGRAPH

After the chronograph is completely assembled and in working condition, replace the hour hand, minute hand, and second hand as you would on a regular watch. At this point, do not replace the sweep second hand, the minute register hand or the hour register hand. Now push the button and bring the flyback lever in toward the center of the watch. When the flyback lever is held in toward the center of the watch, place the sweep second hand at 60 on split second scale "C". Place the minute register hand at 30 on minute register scale "D". Place the hour register hand at 12 on the hour register scale "E". After these hands are replaced, start chronograph mechanism with sweep second hand turning. Let chronograph mechanism run for at least 40 minutes; now push the button to bring the flyback lever in toward the center of the watch again and check to see that the sweep second hand, the minute register hand, and the hour register hand go back to their original position.