

WORLD'S ONLY
FULLY ILLUSTRATED
CHRONOGRAPH WATCH COURSE
VOLUME 16

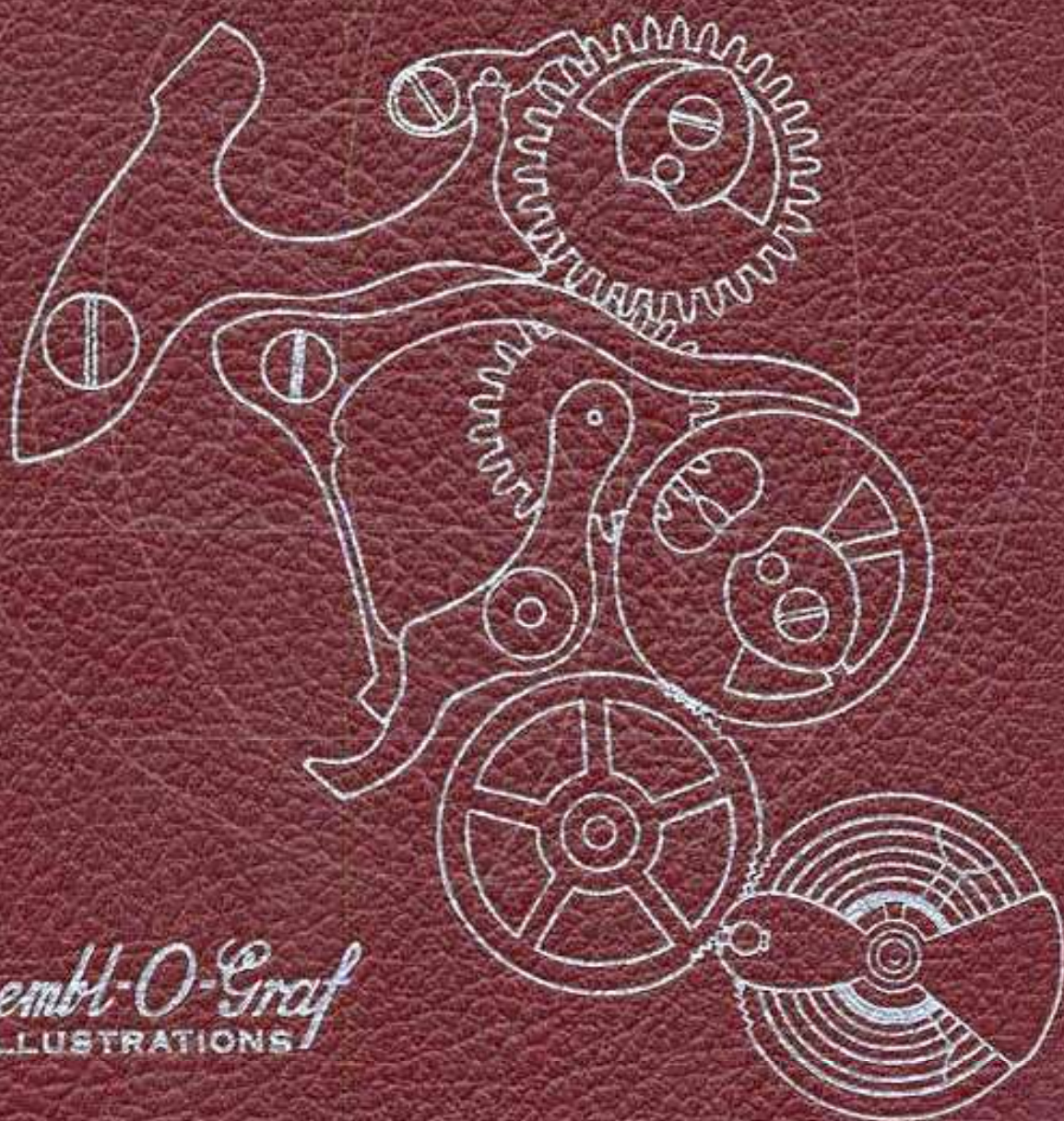

Essemb-O-Graf
ILLUSTRATIONS

IDENTIFICATION OF CHRONOGRAPH

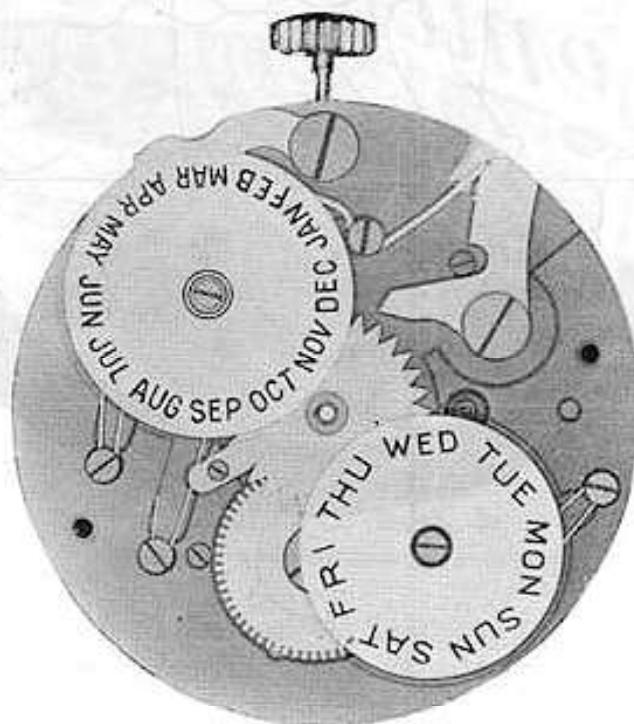

10/1

MOVADO

10

CALENDOGRAPH



ESEMBL-O-GRAF

THE WORLD'S FIRST FULLY
ILLUSTRATED TEXT BOOK
ON
CHRONOGRAPH REPAIRING
AND ADJUSTING

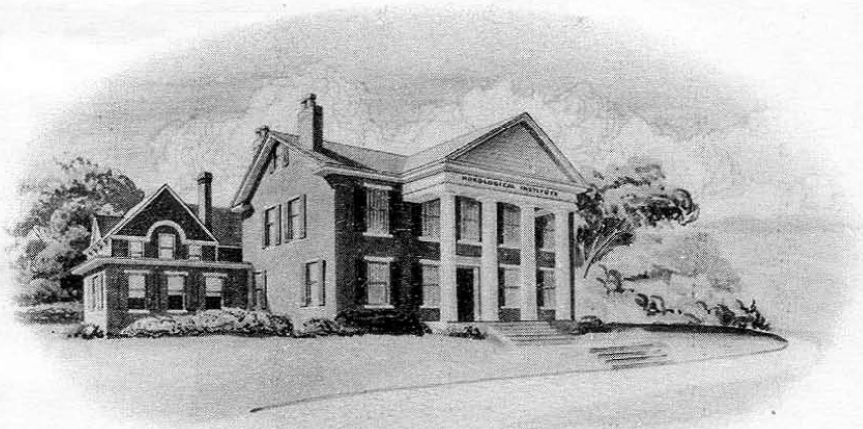

BY
William O. Smith, Sr.
PRESIDENT AND TECHNICAL DIRECTOR
AND
William O. Smith, Jr.
CHIEF ENGINEER, RESEARCH LABORATORIES

WESTERN PENNSYLVANIA HOROLOGICAL INSTITUTE, INC.
PITTSBURGH, PENNSYLVANIA

INSTRUCTIONS

For use of book

DISASSEMBLY OF THE CHRONOGRAPH MECHANISM:

1. Study the isometric drawing at top of page 1-A. The isometric drawing was made for the following purposes:
 - A. It helps to identify the part to be removed.
 - B. This drawing aids in pointing out certain locations on the part that are mentioned in the oiling procedure.
 - C. The text refers to certain points on the part. These points are shown in the isometric drawing. This should aid you in finding the exact location on the part that is described in the text.
 - D. It helps you to know the shape of the part in case a new part has to be made.
2. At the bottom of the page 1-A is a photograph of a chronograph. In this photograph is the same part painted in black. The part is in its exact location that this part occupies in the watch. Find this location in the watch.
3. Read the disassembly procedure and the hazards in disassembly on page 1 in this book.
4. Remove this part in the same procedure as described in the text.
5. A very important item in disassembling a chronograph is keeping the screws in order, much time will be lost in putting the chronograph together if screws are mixed up. This means you have to hunt for each screw, sometimes trying three or four screws before finding the correct one. It cannot be stressed too strongly that care should be taken so that screws are not mixed up. The system that we advise for beginners, is to replace each individual screw after each part is removed. This naturally eliminates the hazard of mixing up the screws and will save you much time in the end. Do this at least until you become so thoroughly familiar with the chronograph that you no longer feel it is necessary.
6. Continue to follow this procedure throughout the book and disassemble each part until the last part of the chronograph is removed.

ASSEMBLY OF THE CHRONOGRAPH MECHANISM:

7. When you are ready to assemble the chronograph mechanism, study the isometric drawing on the last part in this book. This drawing should aid you in identifying the part to be assembled.
8. At the bottom of this page is a photograph of a chronograph. In this photograph is the same part painted in black. The part is in its exact location that this part occupies in the watch.
9. Read the assembly procedure and the hazards in assembling for the last part in this book. (Continued on next page)

INSTRUCTIONS (Continued)

10. Replace the part in its exact location as shown in photograph, using the procedure as described in the text.

11. After you find the correct location for this part in the watch, read the oiling procedure for this part. The oiling procedure for this part is located underneath the isometric drawing. It is best to read the oiling procedure before you put each part in place as there are certain parts that must be oiled immediately as it may prove difficult to oil them later.

12. Replace the screw that holds this part in place. Of course, the screws should be kept in order as we advised above, but if the screws are not in order or the watch was received with screws mixed up, you will find a screw drawn for each part that requires a screw at the bottom of the text page.

13. After replacing this part, replace the next part, etc., until the last part is replaced, which will be part No. 1. Each part should be replaced using the same procedure as described in the text.

(Naturally, the assembly of the chronograph is exactly the reverse of the disassembly)

14. After disassembling and assembling the chronograph mechanism, start on page 1 and read the function of this part. After reading the function of this part, continue to read the function of each part throughout the book. Study each part, one at a time. This text should help you to understand more fully the purpose of each part in the chronograph mechanism.

15. Now put movement in its case with dial on, then replace hands.

16. Study the text on functional results in this book, and check the chronograph mechanism as described in this text.

NOMENCLATURE OF PARTS FOR CHRONOGRAPH MECHANISM







17. After you have become familiar with the chronograph mechanism, you can disassemble and assemble the chronograph by using the nomenclature of parts as a guide. This makes it possible for you to use a procedure without going through each page in the book.

18. ADJUSTMENT OF ECCENTRIC STUDS:

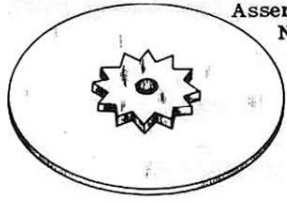
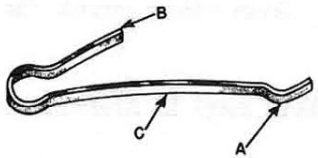
Read the text on adjustment of eccentric studs, this text should be read in reference to the eccentric stud picture. Now adjust each eccentric stud one at a time in the watch, as described in the text. Use the picture to show you the position of these studs.

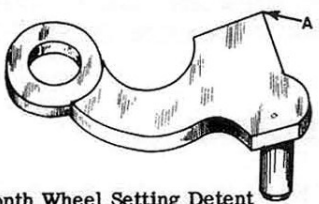
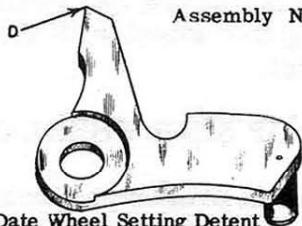
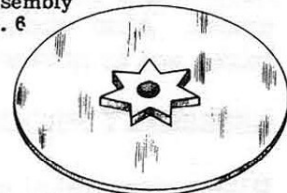
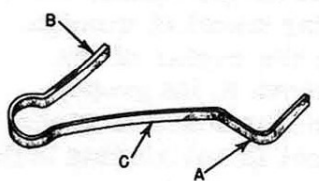
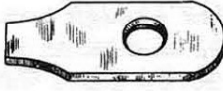
19. On each page in this book the part number and the page number are the same. This makes it convenient for the reader and eliminates any confusion.

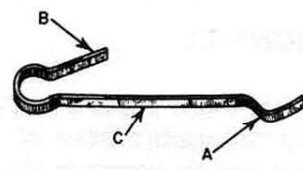
NOMENCLATURE OF PARTS FOR CALENDOGRAPH MECHANISM

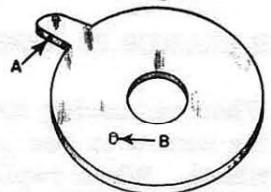
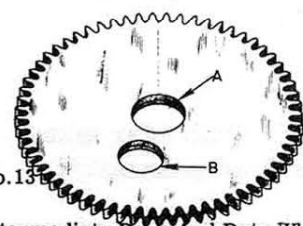
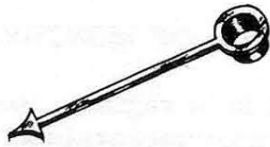
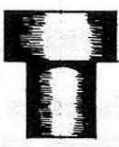
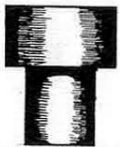
 <p>Assembly No. 1</p> <p>Star Wheel of Months</p>	 <p>Month Wheel Jumper Assembly No.2</p>	 <p>Month Wheel and Date Wheel Setting Detent Spring Assembly No. 3</p>
 <p>Month Wheel Setting Detent Assembly No. 4</p>	 <p>Assembly No. 5</p> <p>Date Wheel Setting Detent</p>	 <p>Assembly No. 6</p> <p>Star Wheel of Days</p>
 <p>Days Wheel Jumper Assembly No. 7</p>	 <p>Date Wheel Bridge Assembly No.8</p>	 <p>Date Wheel Assembly No. 9</p>
 <p>Date Wheel Jumper Assembly No. 10</p>	 <p>Hour Wheel Assembly No.11</p>	 <p>Intermediate Days and Date Wheel Cam Assembly No. 12</p>
 <p>No.13</p> <p>Intermediate Days And Date Wheel</p>	 <p>Date Hand</p>	 <p>Chronograph Button</p>
 <p>Chronograph Button</p>		

PART NO. 1

A. DISASSEMBLY PROCEDURE OF STAR WHEEL OF MONTHS:

The star wheel of months is held in place by fillister head screw FS-1 and pivots on this screw. After this screw is removed, the wheel may be lifted out of place.

(The shape of screw for this part is shown at bottom of page.)

B. HAZARDS IN DISASSEMBLY OF STAR WHEEL OF MONTHS:

Care should be taken in removing this wheel, as a slight slip of the screw-driver in removing the screw can easily scratch the dial on this wheel. Also when handling this wheel with the tweezers, care should be taken not to scratch the dial.

C. ASSEMBLY PROCEDURE OF STAR WHEEL OF MONTHS:

Place star wheel of months in proper position on the plate with the hole in the star wheel over the stud on the plate. Now with a screw-driver force the month wheel jumper away from the center of the watch. At the same time hold a downward pressure on the star wheel of months. When the jumper has moved far enough away from the center of the watch to permit the star wheel of months to drop down in its proper place, replace fillister head screw FS-1 that holds this wheel in place. After wheel is replaced, check to see that this wheel is not binding under the head of fillister screw.

REFERENCE: Month wheel jumper is Assembly 2.

D. HAZARDS IN ASSEMBLY OF STAR WHEEL OF MONTHS:

When replacing star wheel of months, it should be checked before replacing screw to see that month wheel jumper spring is not under star of wheel. When replacing screw, care should be taken not to scratch the dial on this wheel.

REFERENCE: Month wheel jumper is Assembly 2.

E. FUNCTION OF STAR WHEEL OF MONTHS:

The function of this wheel is to register the months. This star wheel of months as in most calendar mechanisms is controlled manually.

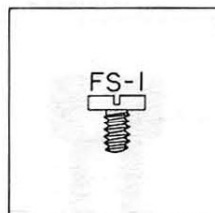

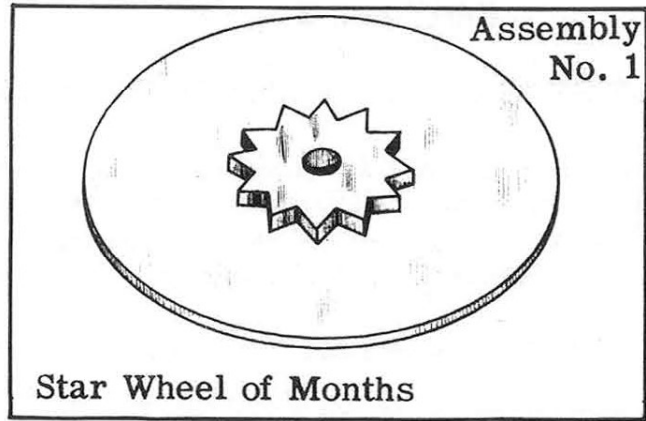

OILING

The star wheel of months should not be oiled.

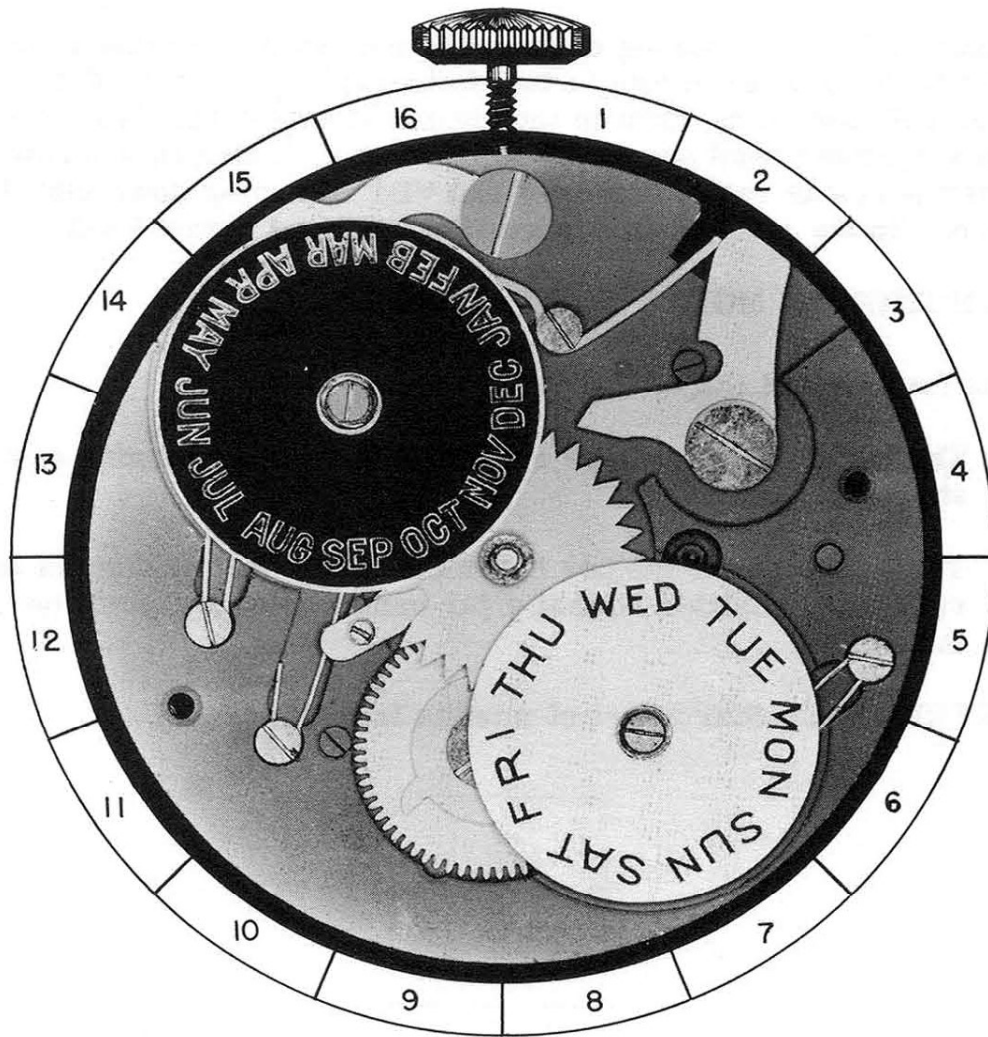

1-A

PART NO. 2

A. DISASSEMBLY PROCEDURE OF MONTH WHEEL JUMPER:

This jumper is held in place by fillister head screw FS-2 and a recess in the plate. Remove fillister head screw FS-2. Grip the jumper at location "C" with a pair of tweezers and lift up to free the loop in jumper from the hollow stud on the plate.

(The shape of screw for this part is shown at bottom of page.)

B. HAZARDS IN DISASSEMBLY OF MONTH WHEEL JUMPER:

When removing this spring as in removing almost any spring that has tension on it, always hold your finger over the spring when lifting it out of place, preventing the spring from jumping away and becoming lost.

C. ASSEMBLY PROCEDURE OF MONTH WHEEL JUMPER:

Place end "A" of spring down in the recess in the plate in its proper position as shown in the photograph. End "B" of spring does not have to be down in the recess at this point. Now replace fillister head screw FS-2, but do not tighten this screw. After screw is replaced, force end "B" of spring down into the recess in the plate; then tighten fillister head screw FS-2.

D. FUNCTION OF MONTH WHEEL JUMPER:

The functions of the month wheel jumper are:

1. The month wheel jumper correctly spaces the turning of the star wheel of months.
2. The month wheel jumper holds the star wheel of months in a stationary position so that a jar cannot alter the position of this wheel.

REFERENCE: Star wheel of months is Assembly 1.

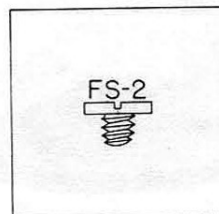

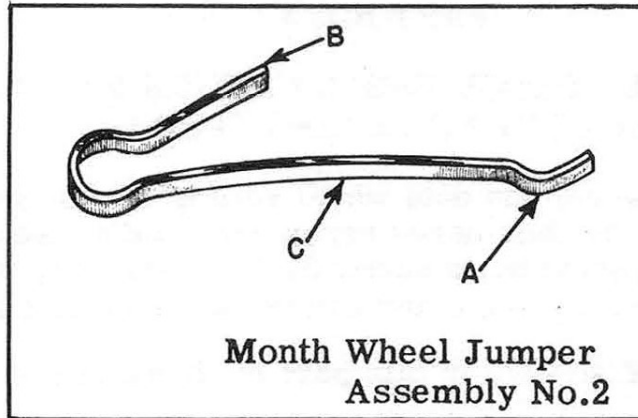

Month Wheel Jumper
Assembly No.2

OILING

The month wheel jumper should not be oiled.

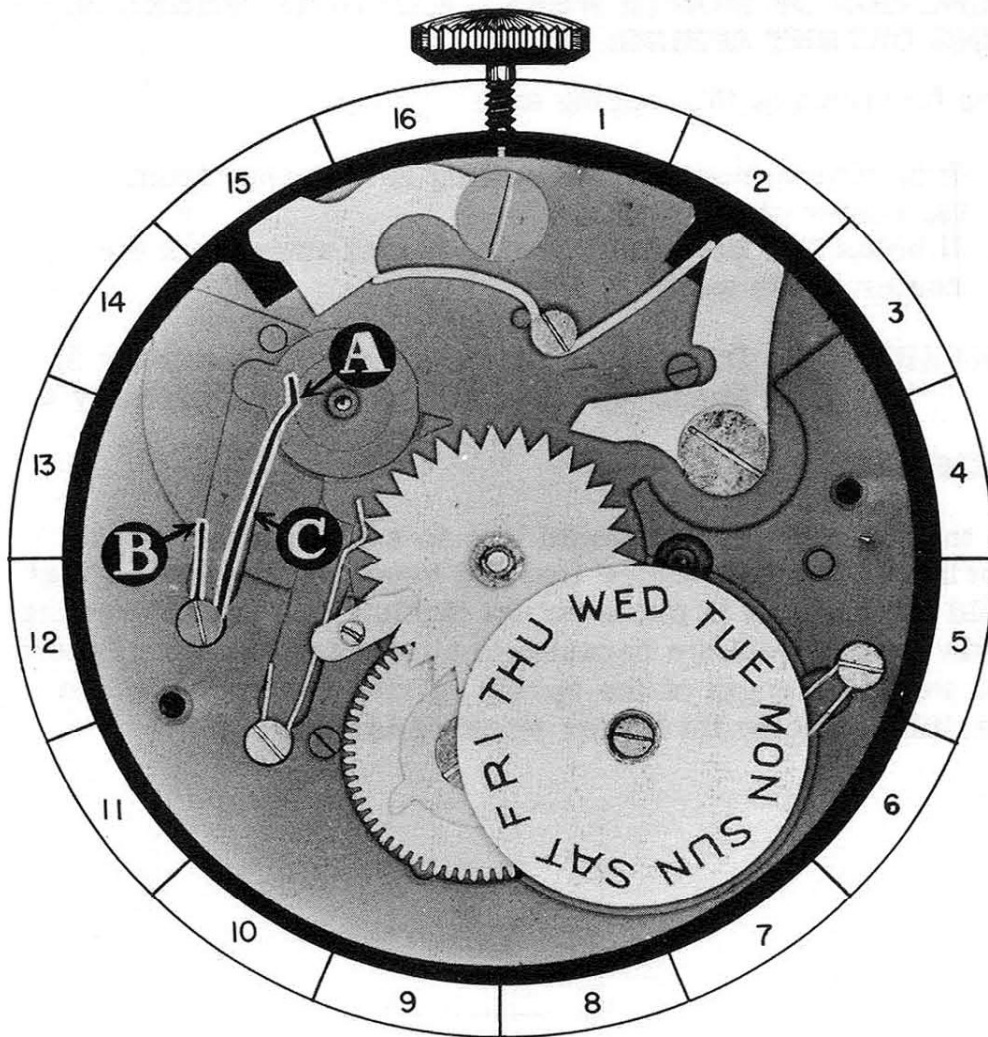

2-A

PART NO. 3

A. DISASSEMBLY PROCEDURE OF MONTH WHEEL AND DATE WHEEL SETTING DETENT SPRING:

This month wheel and date wheel setting detent spring is held in place by shouldered screw SS-1 and a post on the plate. After shouldered screw SS-1 is removed, the spring will be free on the plate and can be lifted out of place.

(The shape of screw for this part is shown at bottom of page.)

B. ASSEMBLY PROCEDURE OF MONTH WHEEL AND DATE WHEEL SETTING DETENT SPRING:

Place this spring in proper position on plate as shown in the photograph. Notice how spring is placed in relation to pin "C" on plate. Now replace shouldered screw SS-1.

C. FUNCTION OF MONTH WHEEL AND DATE WHEEL SETTING DETENT SPRING:

The functions of this spring are:

1. It holds the month wheel setting detent away from the center of the watch.
2. It holds the date wheel setting detent away from the center of the watch.

REFERENCE: Date wheel setting detent is Assembly 5.
Month wheel setting detent is Assembly 4.

REMARKS:

In this calendograph I would like to call attention to the springs. You will notice that the heads of the screws that hold the springs in place do not tighten down on the spring. This is an advantage because in most cases this increases the working length of the spring, giving the spring more flexibility due to its longer working length.

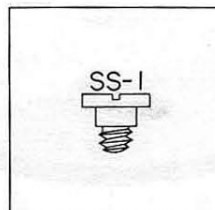

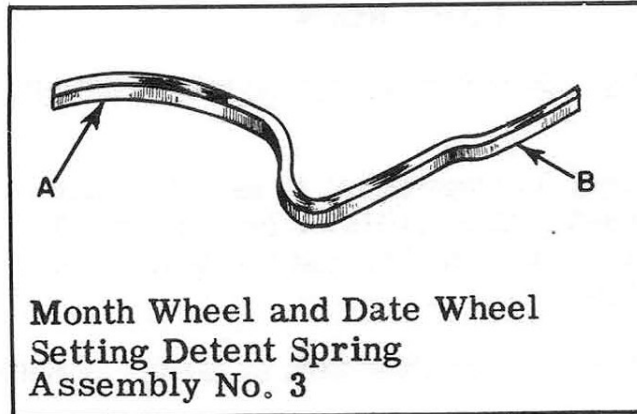

OILING

Slightly moisten this spring with oil at these points:

1. End "A" that contacts month wheel setting detent lever.
2. End "B" that contacts date wheel setting detent lever.

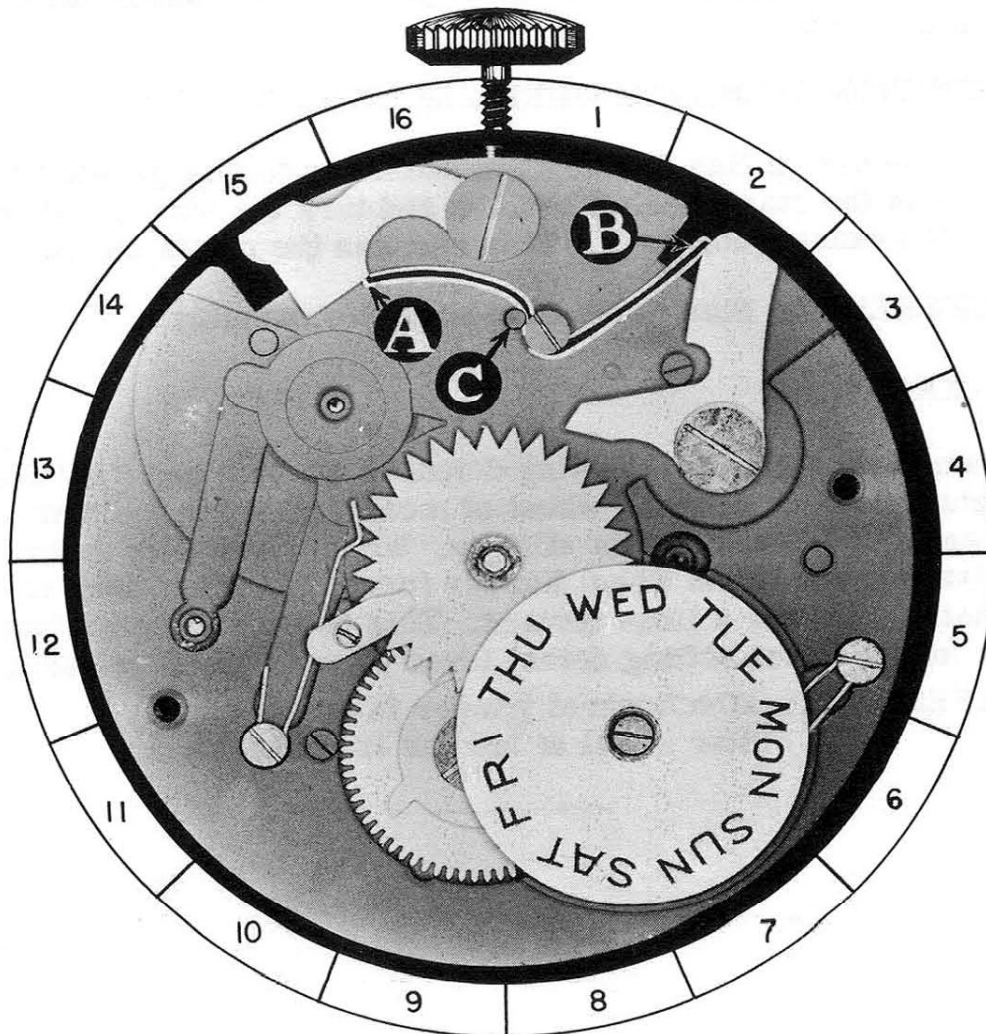

PART NO. 4

A. DISASSEMBLY PROCEDURE OF MONTH WHEEL SETTING DETENT:

The month wheel setting detent is held in place by fillister head screw FS-3. After fillister head screw FS-3 is removed lift straight up on detent, freeing the detent from the hollow stud on the plate.

(The shape of screw for this part is shown at bottom of page.)

B. ASSEMBLY PROCEDURE OF MONTH WHEEL SETTING DETENT:

Place the month wheel setting detent in proper position on the plate, with the hole in detent over the hollow stud on plate as shown in the photograph. Now replace fillister head screw FS-3. After this screw is replaced, check the month wheel setting detent to see that it pivots freely under the head of this screw.

C. FUNCTION OF MONTH WHEEL SETTING DETENT:

The function of this detent when pushed is to engage with the teeth on the star wheel of months and turn the star wheel of months exactly one tooth. This changes the month on the dial.

REFERENCE: Star wheel of months is Assembly 1.

REMARKS:

When the month wheel setting detent is pushed, end "A" contacts a tooth on the star wheel of months, forcing the star wheel of months to rotate slightly. When the setting detent is released, the month wheel jumper forces the star wheel of months to rotate a little further. This is repeated each time the month wheel setting detent lever is pushed and released.

REFERENCE: Month wheel jumper is Assembly 2.
Star wheel of months is Assembly 1.

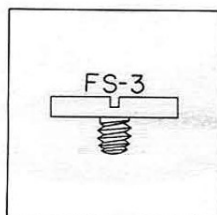

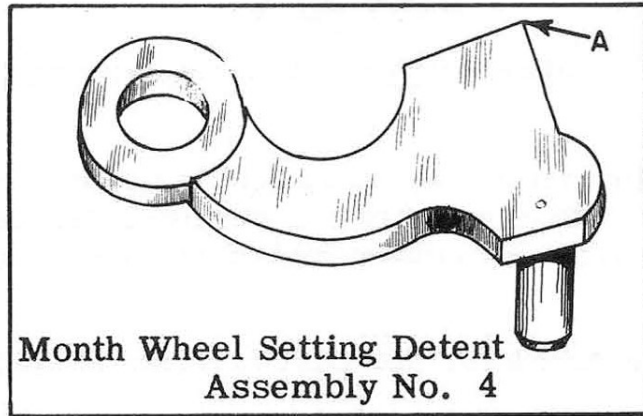

OILING

The hollow stud on plate on which the month wheel setting detent lever pivots should be slightly moistened with oil.

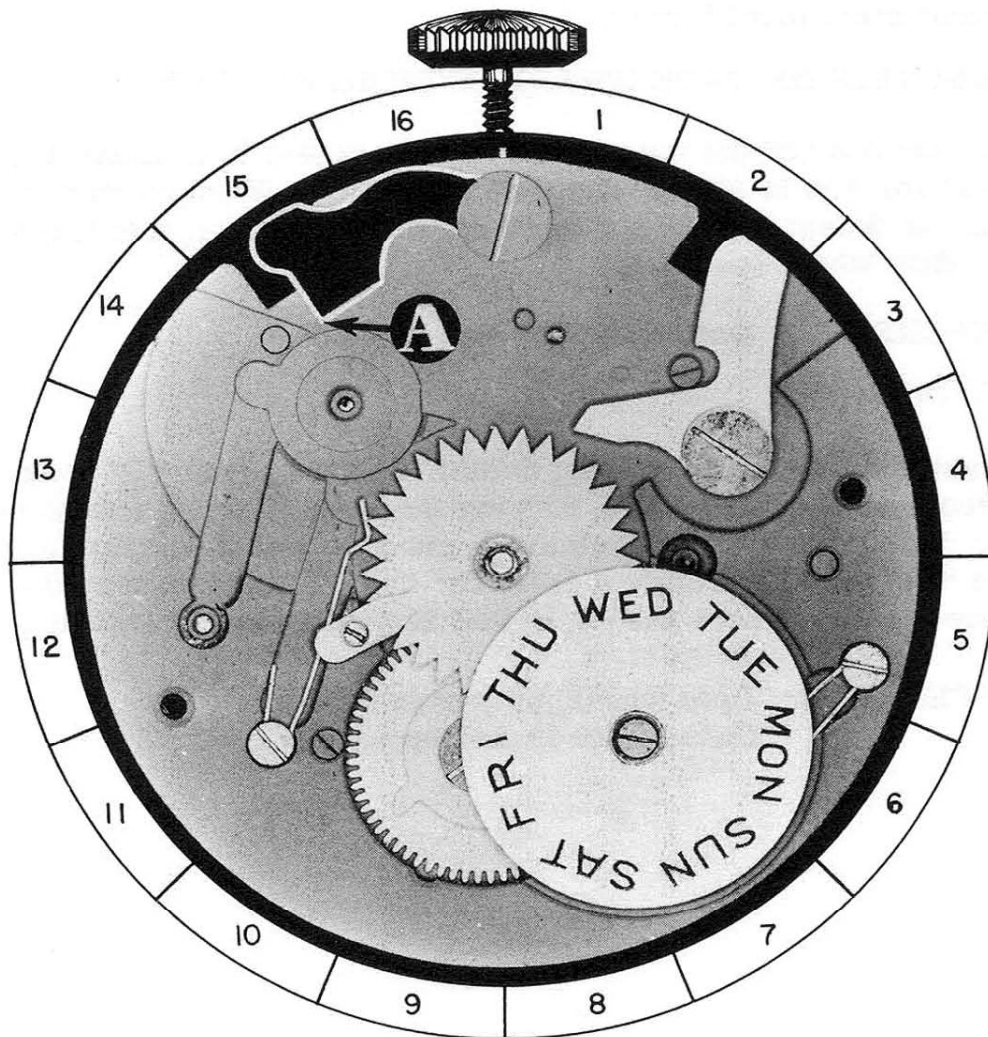

4-A

PART NO. 5

A. DISASSEMBLY PROCEDURE OF DATE WHEEL SETTING DETENT:

The date wheel setting detent is held in place by fillister head screw FS-4. When this screw is removed, the setting detent can be lifted from the hollow stud on the plate and lifted out of place.

(The shape of screw for this part is shown at bottom of page.)

B. ASSEMBLY PROCEDURE OF DATE WHEEL SETTING DETENT:

Place date wheel setting detent in its proper position on the plate as shown in the photograph. The hole in detent is placed over the hollow stud on the plate. After detent is in its proper position, replace fillister screw FS-4. Now check detent to see that it pivots freely under the head of this screw. This detent must pivot freely.

C. FUNCTION OF DATE WHEEL SETTING DETENT:

The function of the date wheel setting detent is to make it possible for you to change the date manually. When pushed, end "D" of detent contacts a tooth on the date wheel, and turns the date wheel one tooth.

REFERENCE: Date wheel is Assembly 9.

REMARKS:

When the date wheel setting detent is pushed, end "D" contacts a tooth on the date wheel, forcing the date wheel to rotate slightly. When the detent is released, the date wheel jumper forces the date wheel to rotate a little further. This is repeated each time the date wheel setting detent is pushed and released.

REFERENCE: Date wheel jumper is Assembly 10.
Date wheel is Assembly 9.

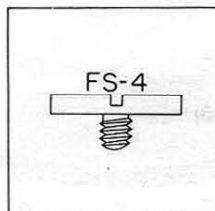

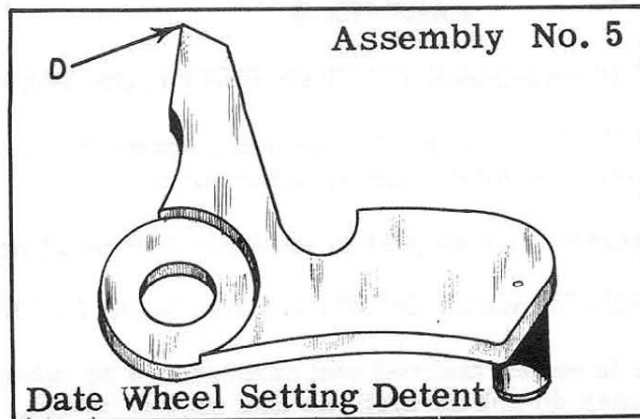

OILING

The hollow stud on plate on which the date wheel setting detent lever pivots should be slightly moistened with oil.

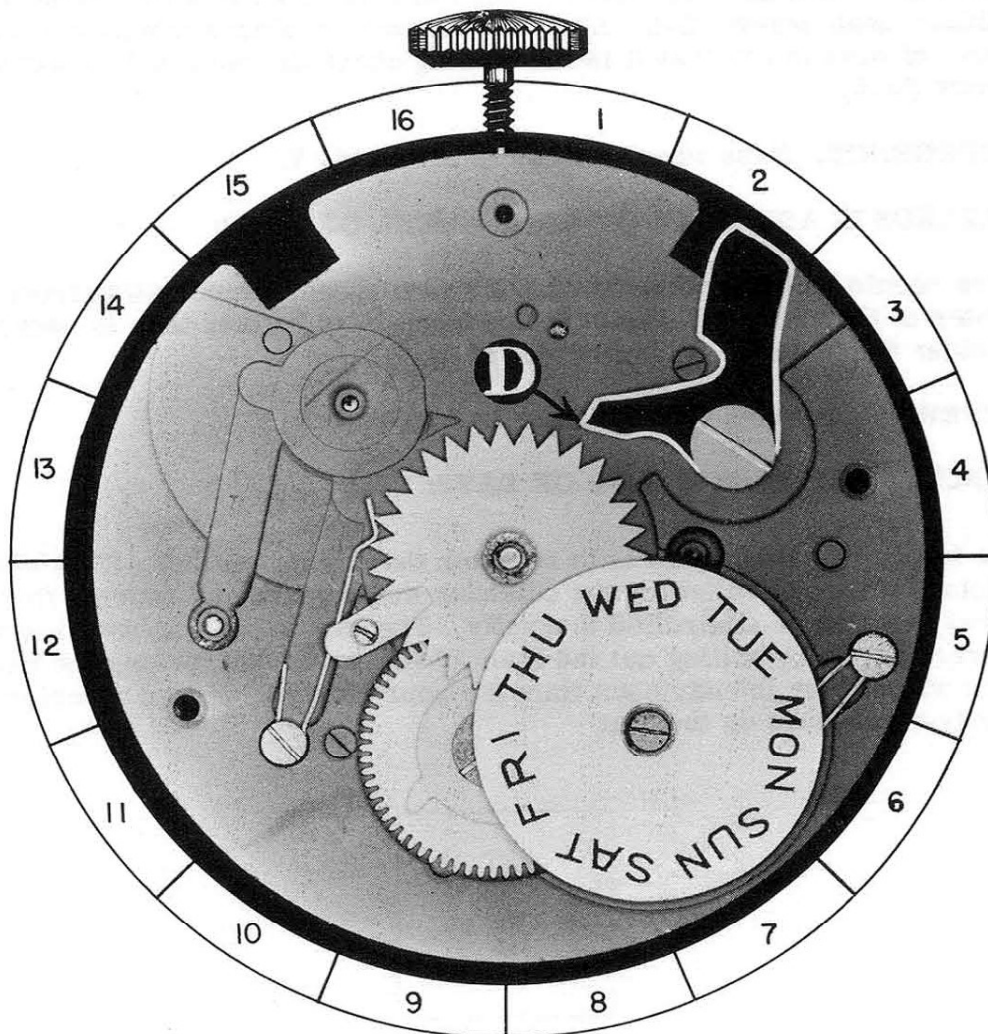

5-A

PART NO. 6

A. DISASSEMBLY PROCEDURE OF STAR WHEEL OF DAYS:

This wheel is held in place by fillister head screw FS-5. After this screw is removed, the wheel can be lifted out of place.

(The shape of screw for this part is shown at bottom of page.)

B. HAZARDS IN DISASSEMBLY OF STAR WHEEL OF DAYS:

The days wheel is easily marred and care should be taken that the screw-driver or tweezers do not scratch the dial on this wheel.

C. ASSEMBLY PROCEDURE OF STAR WHEEL OF DAYS:

Place the star wheel of days in its proper position on the plate as shown in the photograph. Now take a small screw-driver and force the days wheel jumper away from the center of the watch at the same time holding a downward pressure on the star wheel of days. As soon as the days wheel jumper has been moved far enough away from the center of the watch to permit the star wheel of days to drop down in place, replace fillister head screw FS-5. After the screw is replaced, check the star wheel of days to see that it is not binding under the head of fillister head screw FS-5.

REFERENCE: Days wheel jumper is Assembly 7.

D. HAZARDS IN ASSEMBLY OF STAR WHEEL OF DAYS:

Care should be taken when forcing the days wheel jumper away from the center of the watch. It should not be forced any further than is necessary to clear the teeth on the star wheel of days.

REFERENCE: Days wheel jumper is Assembly 7.

E. FUNCTION OF STAR WHEEL OF DAYS:

The function of this wheel is to register the day on the dial. This wheel is automatically controlled by the calendar mechanism. Of course, this wheel can also be controlled manually. The way to set this wheel to the correct day is by pulling out the stem of the watch and turning the hands. This will change the day each time the hour hand has moved a period of twenty-four hours on the dial.

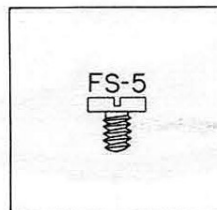

Assembly
No. 6

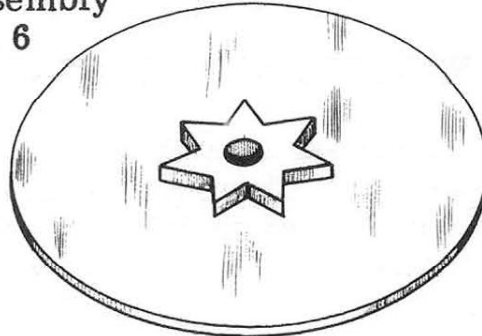

Star Wheel of Days

OILING

The star wheel of days should not be oiled.

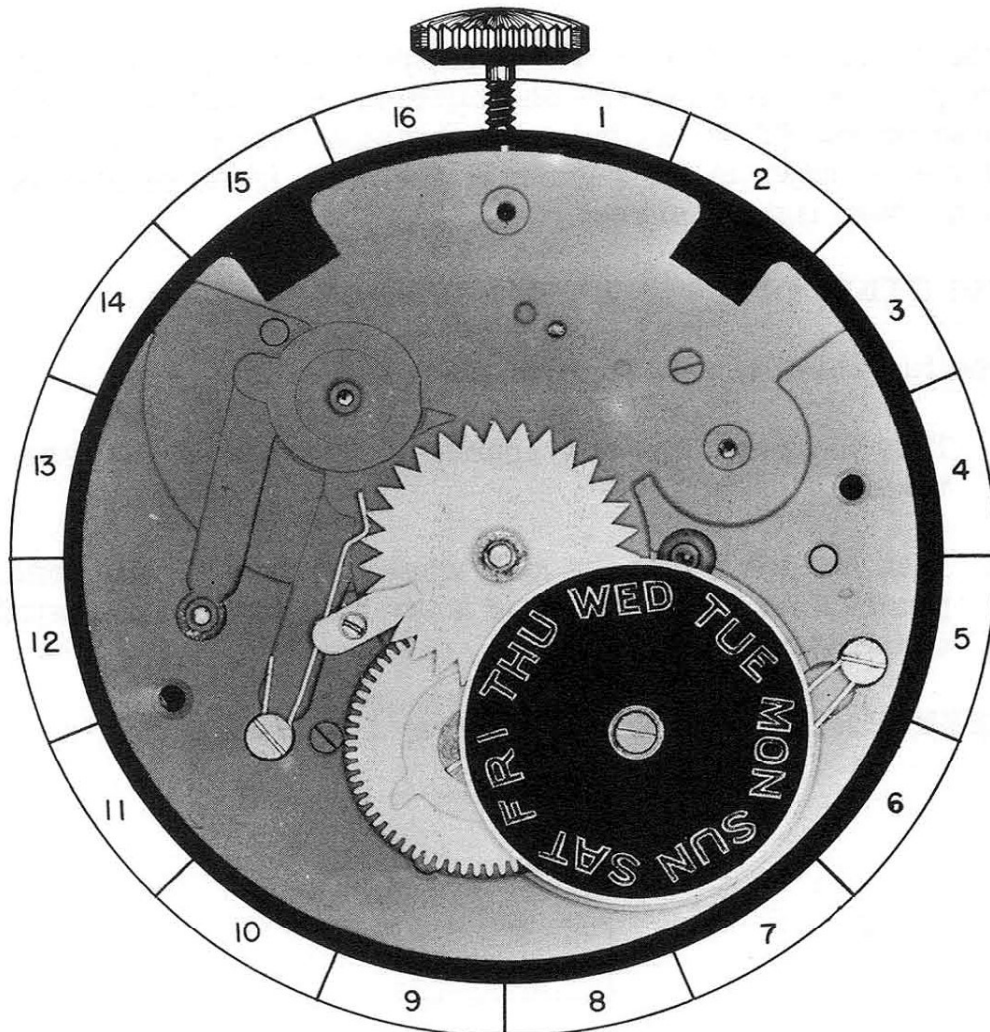

6-A

PART NO. 7

A. DISASSEMBLY PROCEDURE OF DAYS WHEEL JUMPER:

This jumper is held in place by fillister head screw FS-6 and a recess in the plate. Remove fillister head screw FS-6. Grip jumper at location "C" with a pair of tweezers and lift up freeing the loop in jumper from the hollow stud on the plate.

(The shape of screw for this part is shown at bottom of page.)

B. HAZARDS IN DISASSEMBLY OF DAYS WHEEL JUMPER:

Hold finger over spring when removing it so that spring cannot shoot away.

C. ASSEMBLY PROCEDURE OF DAYS WHEEL JUMPER:

Place end "A" of days wheel jumper in its proper position on the plate as shown in the photograph. Now replace fillister head screw FS-6, but before tightening screw, force end "B" of spring down in the recess in the plate in its proper position. Now tighten screw.

D. FUNCTION OF DAYS WHEEL JUMPER:

The functions of this jumper are:

1. This jumper correctly spaces the turning of the star wheel of days.
2. This jumper holds the star wheel of days in its proper position so that a bump or a jar cannot alter the position of this wheel.

REFERENCE: Star wheel of days is Assembly 6.

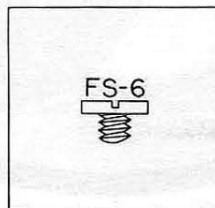

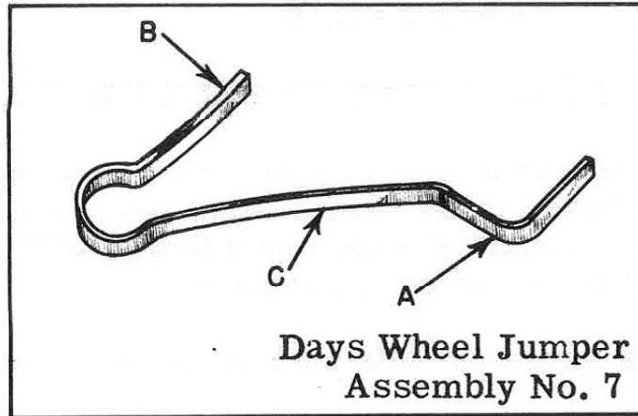

OILING

The days wheel jumper should not be oiled.

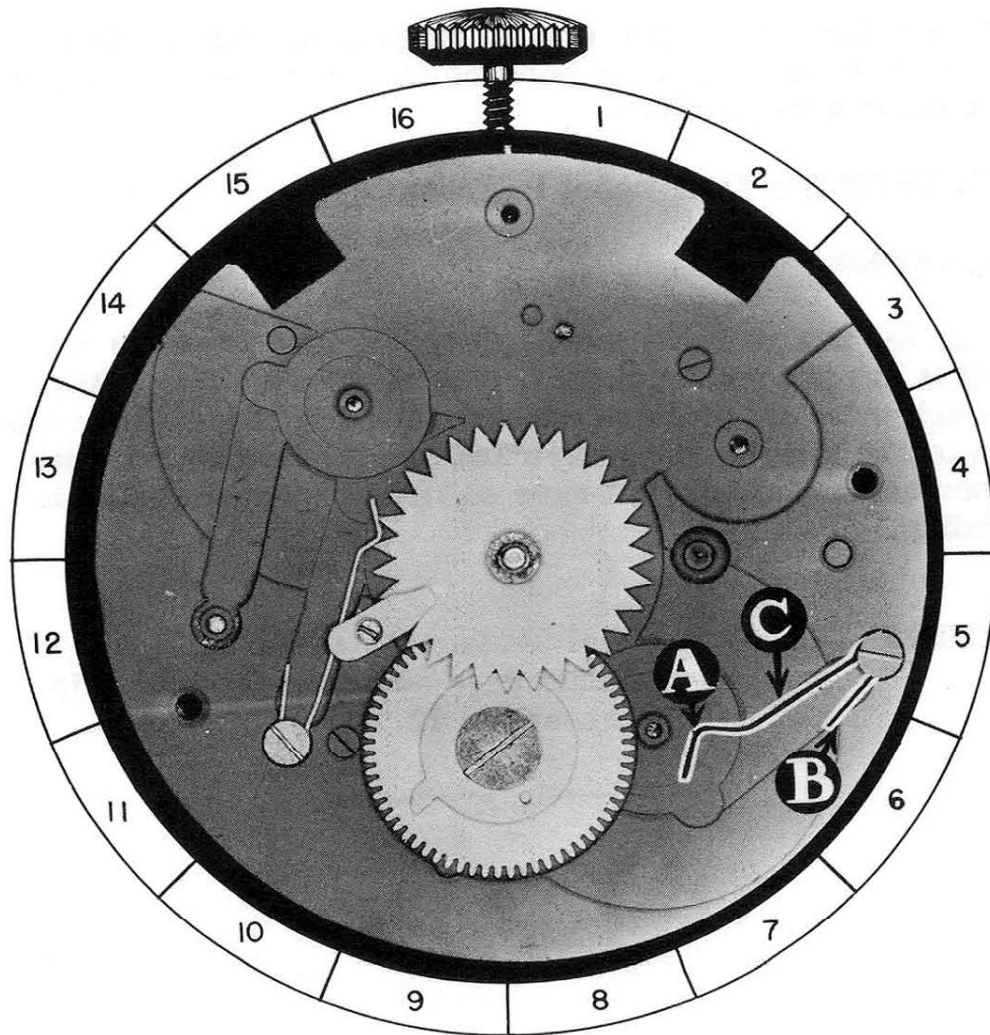

7-A

PART NO. 8

A. DISASSEMBLY PROCEDURE OF DATE WHEEL BRIDGE:

This bridge is held in place by beveled countersink screw BS-1, and a recess in the plate. After beveled countersink screw BS-1 is removed, date wheel bridge will be free on the plate and can be lifted out of place.

(The shape of screw for this part is shown at bottom of page.)

B. ASSEMBLY PROCEDURE OF DATE WHEEL BRIDGE:

Place the date wheel bridge in its proper position on the plate as shown in the photograph. Now replace beveled countersink screw BS-1.

C. FUNCTION OF DATE WHEEL BRIDGE:

The function of the date wheel bridge is to hold the date wheel down in its proper position keeping it from riding up and coming out of place.

REFERENCE: Date wheel is Assembly 9.

REMARKS:

After the bridge is replaced, check the date wheel to see that it has proper endshake. This wheel should not rise enough to be out of mesh with the date wheel jumper or the pin on the intermediary days and date wheel cam. On the other hand, it should not have so little endshake that it is binding.

REFERENCE: Date wheel jumper is Assembly 10.
Intermediate days and date wheel cam is
Assembly 12.

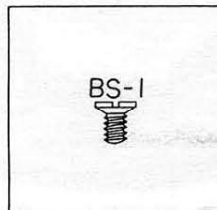

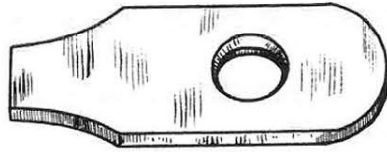

Date Wheel Bridge
Assembly No.8

OILING

The date wheel bridge should not be oiled.

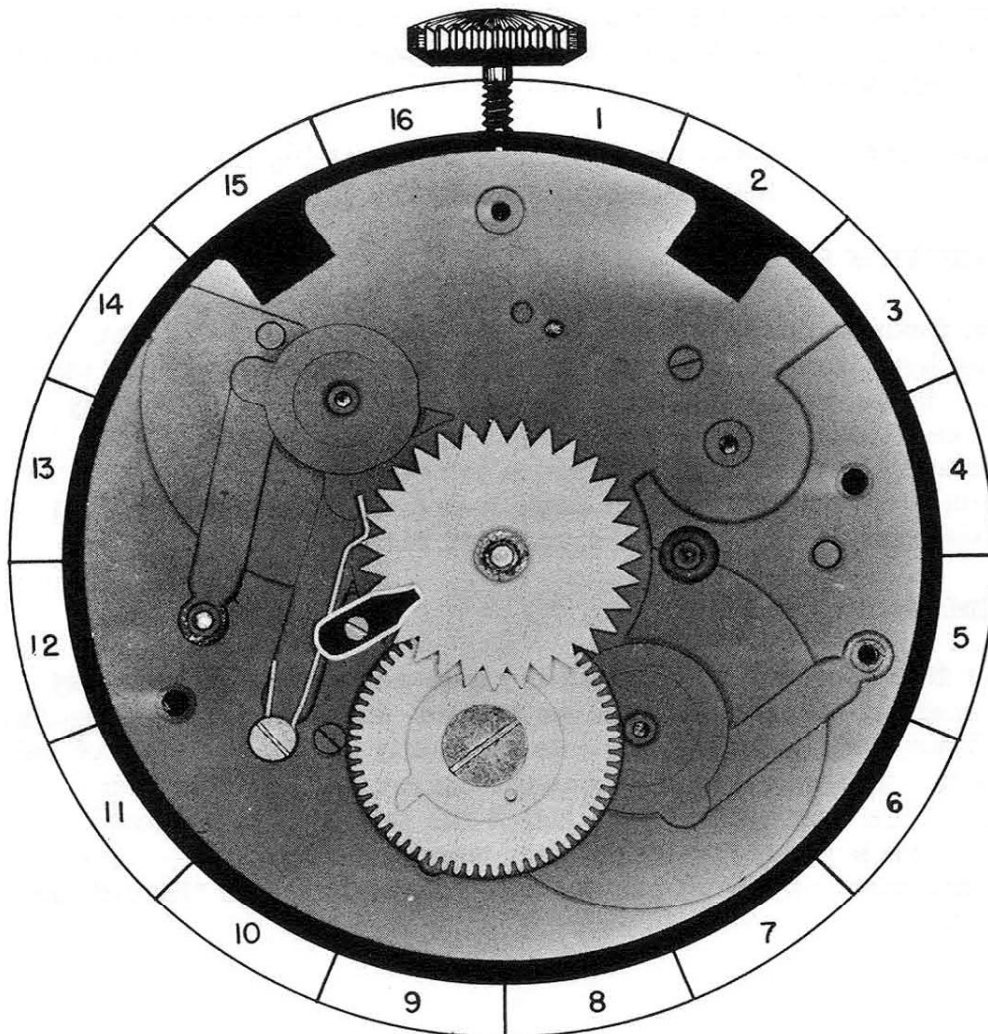

8-A

PART NO. 9

A. DISASSEMBLY PROCEDURE OF DATE WHEEL:

To remove this wheel simply lift straight up on wheel freeing it from the hour wheel tube.

REFERENCE: Hour wheel is Assembly 11.

B. ASSEMBLY PROCEDURE OF DATE WHEEL:

Place the date wheel in its proper position on the plate with the hole in date wheel over the hour wheel.

REFERENCE: Hour wheel is Assembly 11.

C. HAZARDS IN ASSEMBLY OF DATE WHEEL:

When replacing date wheel, be sure the date wheel jumper is not under date wheel but meshes with the teeth on this wheel. The date wheel should not be a friction fit on the hour wheel but should turn freely when date wheel jumper is not in contact with the date wheel.

REFERENCE: Date wheel jumper is Assembly 10.
Hour wheel is Assembly 11.

D. FUNCTION OF DATE WHEEL:

The function of the date wheel is to register the date. This is done by a hand being attached to this wheel which records the date on the dial. This date wheel is controlled mechanically by the calendar mechanism. This wheel is also controlled manually for setting the watch to the correct date. After it is once set for the correct date, it is from then on controlled mechanically as long as the watch is running.

REMARKS:

The date mechanism changes the date automatically each day. Of course, this mechanism, as in most all calendar mechanisms, will not always change the date correctly on the first day of each month. The date will only change correctly if the previous month has thirty-one days. But if the previous month had only thirty days or less, then the date would not change correctly. In this case, you must set the date manually on the first of the month.

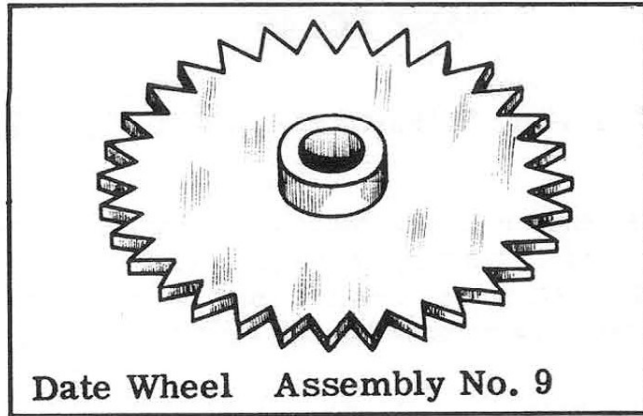

OILING

The date wheel should not be oiled.

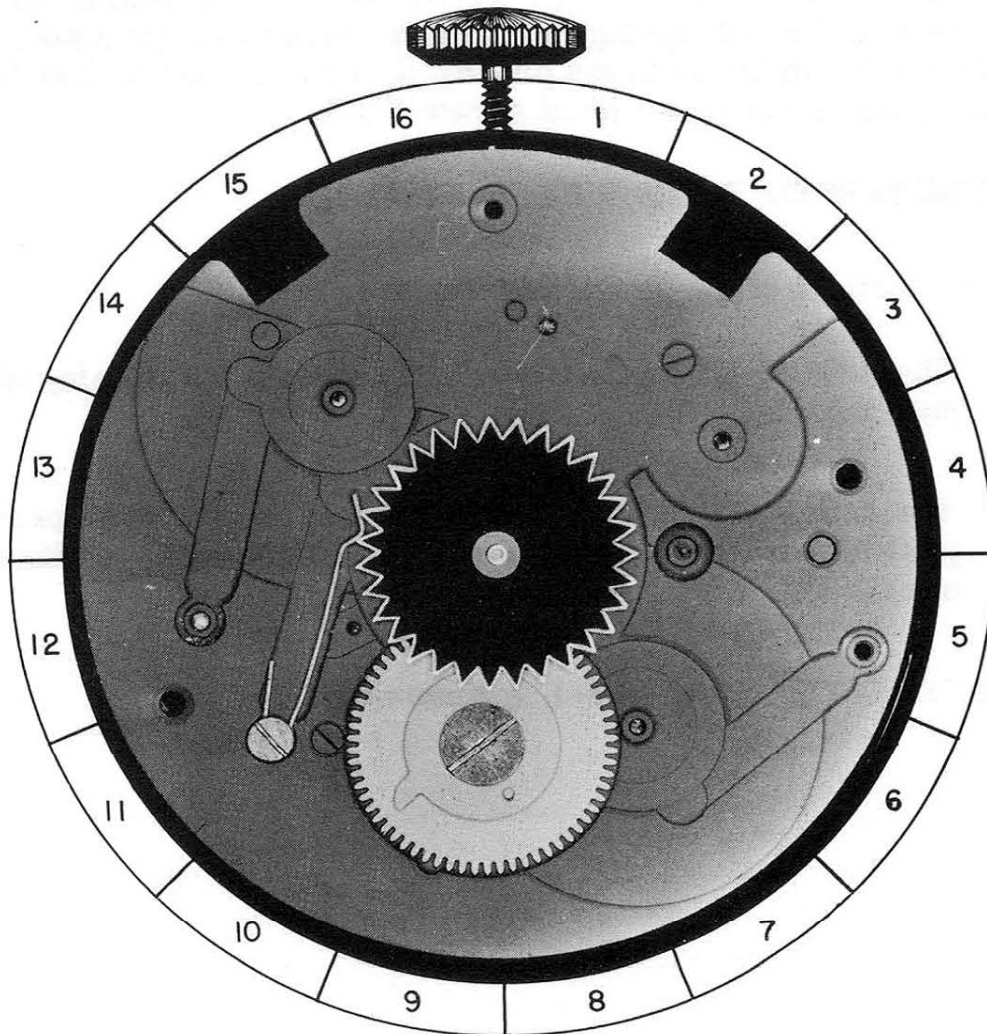

PART NO. 10

A. DISASSEMBLY PROCEDURE OF DATE WHEEL JUMPER:

This jumper is held in place by fillister head screw FS-2 and a recess in the plate. Remove fillister head screw FS-2. Grip the jumper at location "C" with a pair of tweezers and lift up to free the loop in jumper from the hollow stud on the plate.

(The shape of screw for this part is shown at bottom of page.)

B. ASSEMBLY PROCEDURE OF DATE WHEEL JUMPER:

Place end "A" of date wheel jumper down in its proper position in recess in the plate as shown in the photograph. Now replace fillister head screw FS-7. Before tightening screw, force end "B" of spring down in the recess in the plate. After this spring is in its proper position in the recess in the plate, tighten fillister head screw FS-7.

C. FUNCTION OF DATE WHEEL JUMPER:

The functions of the month wheel jumper are:

1. The date wheel jumper correctly spaces the turning of the date wheel.
2. The date wheel jumper holds the date wheel in its proper position so that a bump or jar cannot alter the position of this wheel.

REFERENCE: Date wheel is Assembly 9.

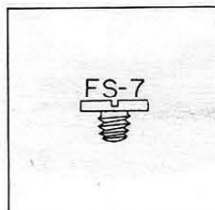

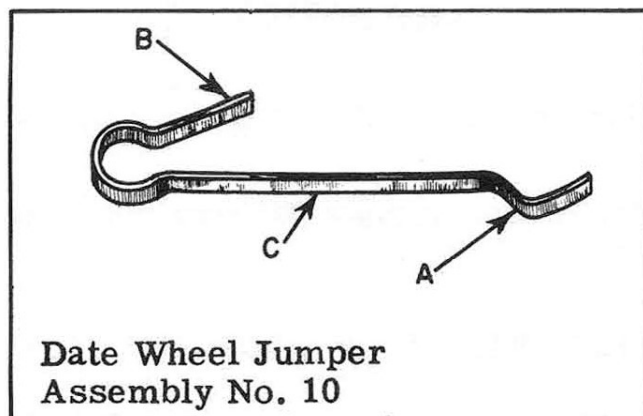

OILING

The date wheel jumper should not be oiled.

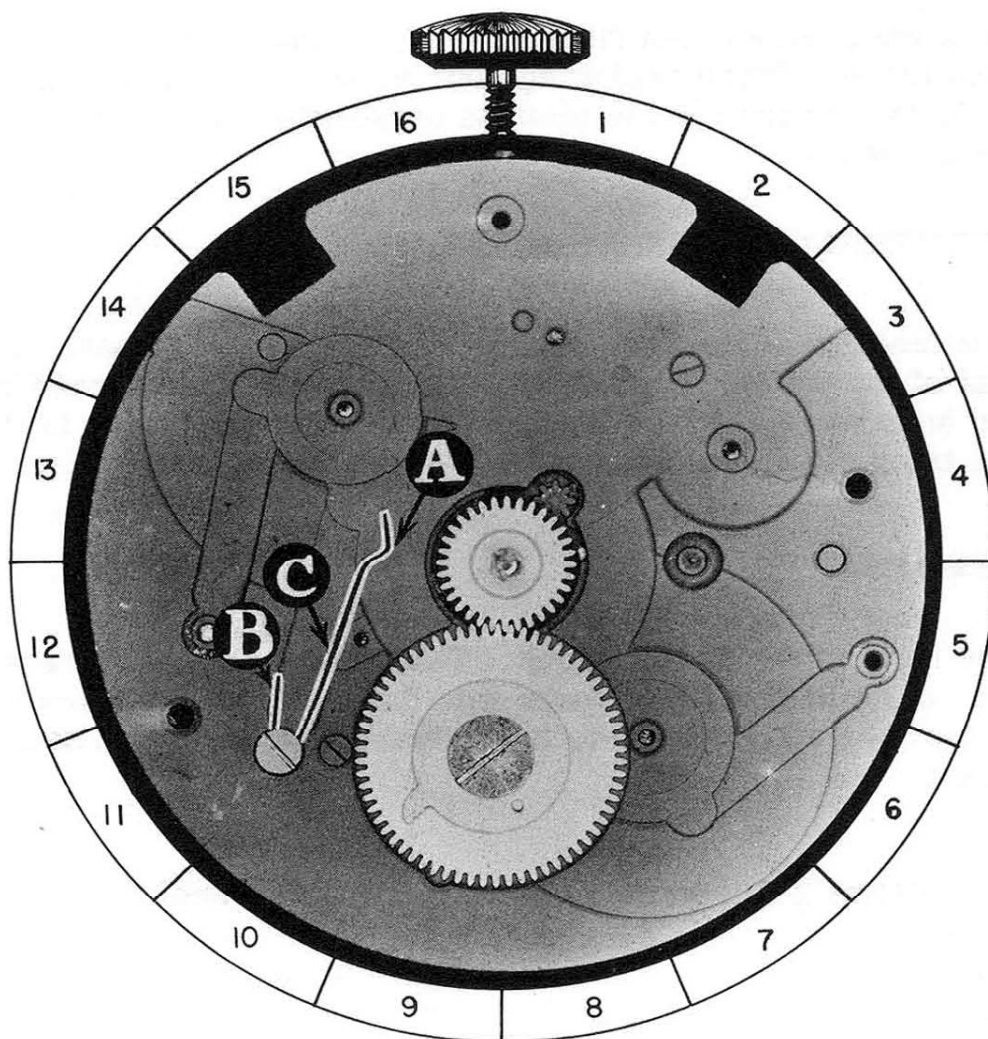

10-A

PART NO. 11

A. DISASSEMBLY PROCEDURE OF HOUR WHEEL:

To remove this wheel, simply lift straight up on wheel lifting it out of place.

B. ASSEMBLY PROCEDURE OF HOUR WHEEL:

Place the hour wheel over the cannon pinion as shown in the photograph. Now push wheel down in the proper place so that the teeth on the hour wheel mesh into the pinion on the minute wheel.

C. HAZARDS IN ASSEMBLY OF HOUR WHEEL:

This wheel should not fit tight on the cannon pinion but should turn freely. When replacing hour wheel, be sure that it is down far enough for the teeth to mesh with the pinion on the minute wheel.

D. FUNCTION OF HOUR WHEEL:

The function of the hour wheel is to register the hours on the dial of the watch. This is done by a hand being attached to the hour wheel. Also this wheel transmits the power from the train of the watch to the calendar mechanism.

REMARKS:

The hour wheel is very thick. This makes it possible for the hour wheel teeth to mesh into the pinion of the minute wheel, and also mesh into the intermediate days and date wheel.

REFERENCE: Intermediate days and date wheel is
Assembly 13.

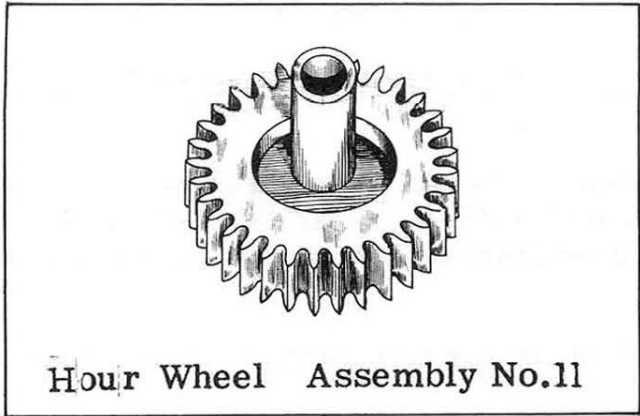

OILING

The hour wheel should not be oiled.

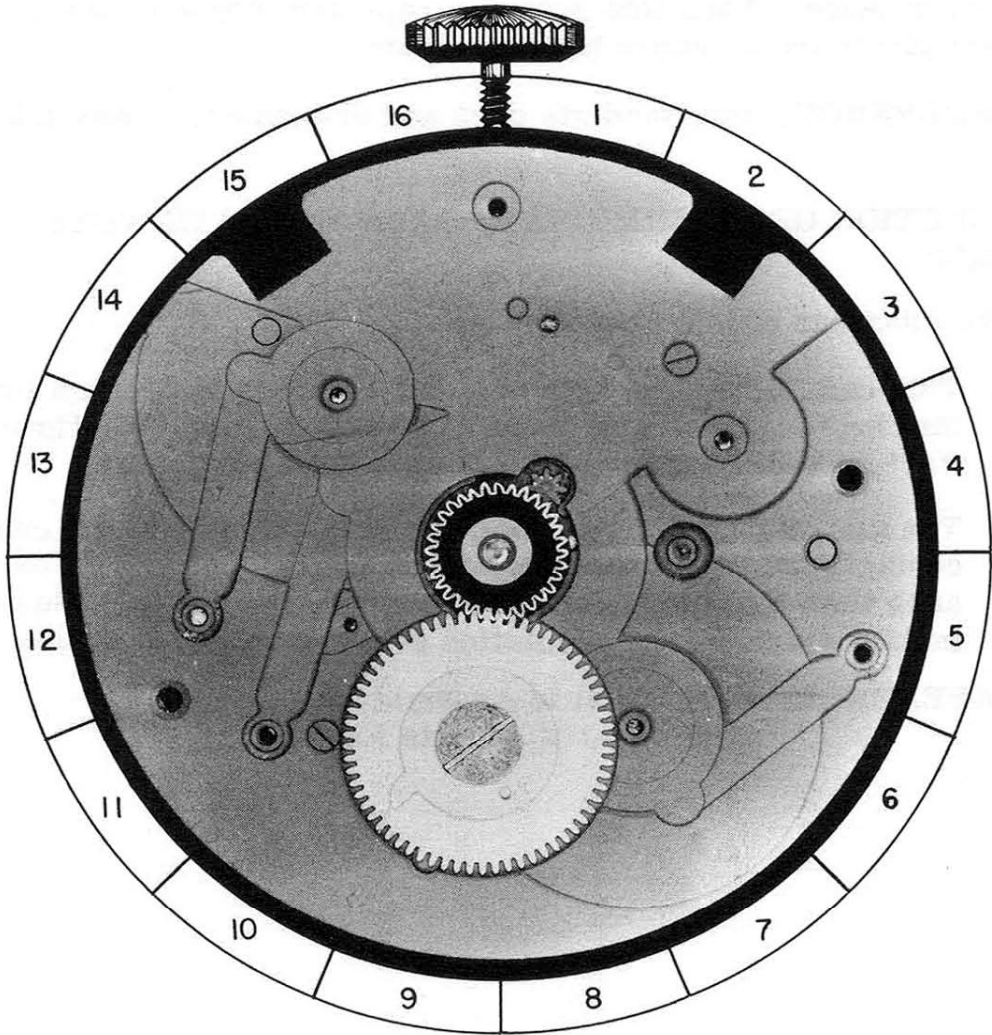

PART NO. 12

A. DISASSEMBLY PROCEDURE OF INTERMEDIATE DAYS AND DATE WHEEL CAM:

The intermediate days and date wheel cam is held in place by fillister head screw FS-8. After this screw is removed, this cam can be lifted from hollow stud on plate and lifted out of place.

(The shape of screw for this part is shown at bottom of page.)

B. ASSEMBLY PROCEDURE OF INTERMEDIATE DAYS AND DATE WHEEL CAM:

Place the intermediate days and date wheel cam in its proper position on the intermediate days and date wheel with the hole in cam over hollow stud on plate. Pin "B" on lower side of cam must fit down in hole "B" in intermediate days and date wheel. Now replace fillister head FS-8 that holds this part in place. When this screw is replaced, check to see that cam pivots freely under head of screw.

REFERENCE: Intermediate days and date wheel is Assembly 13.

C. FUNCTION OF INTERMEDIATE DAYS AND DATE WHEEL CAM:

The functions of this cam are:

1. This cam moves the star wheel of days one tooth each time the finger "A" on cam makes one revolution. This finger "A" makes one revolution every twenty-four hours.
2. The pin "B" on the intermediate days and date wheel cam contacts the date wheel and moves the date wheel one tooth each time this pin makes one complete revolution. This pin makes one complete revolution every twenty-four hours.

REFERENCE: Date wheel is Assembly 9.
Star wheel of days is Assembly 6.

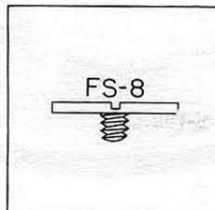

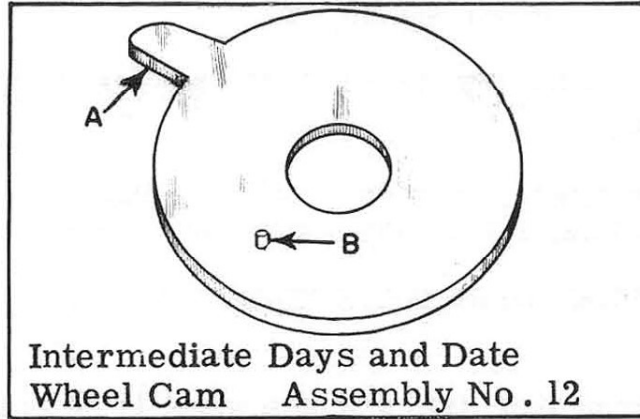

OILING

The hollow stud on which the intermediate days and date wheel cam pivots should be slightly moistened with oil.

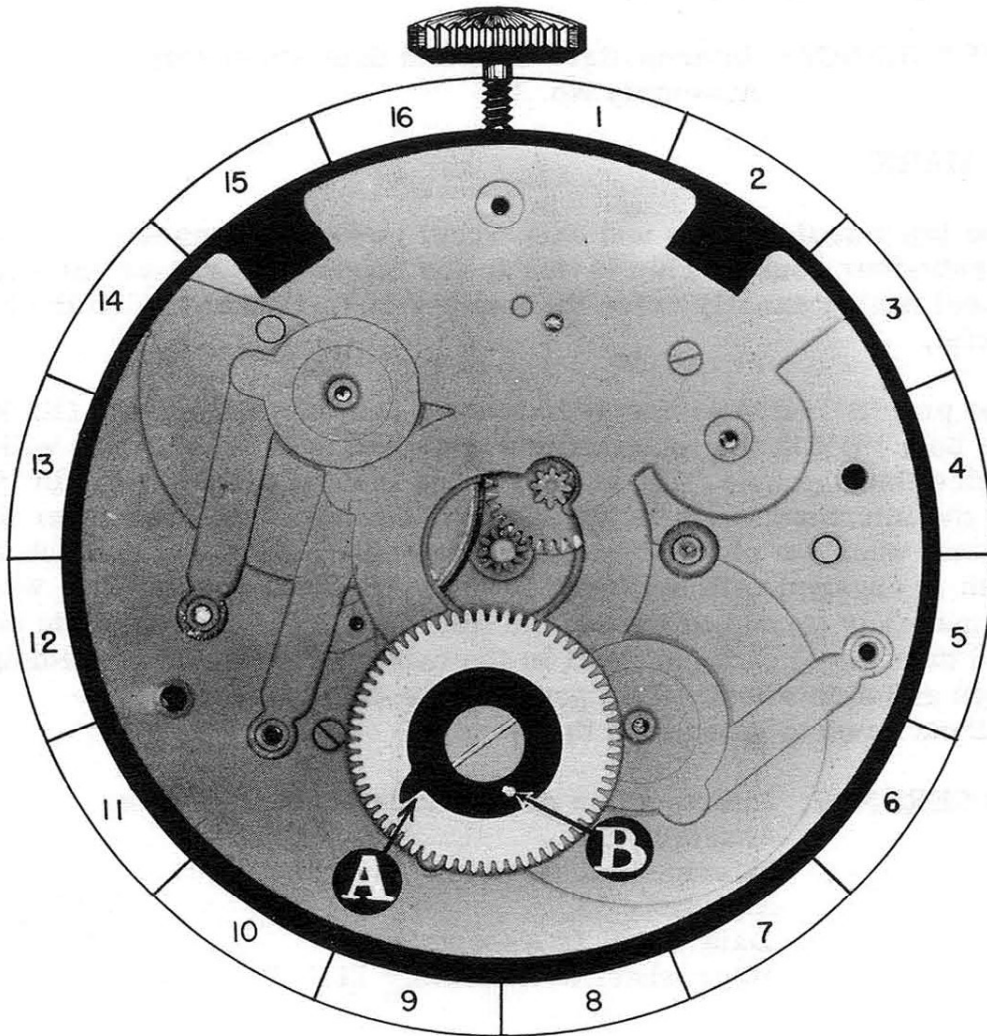

12-A

PART NO. 13

A. DISASSEMBLY PROCEDURE OF INTERMEDIATE DAYS AND DATE WHEEL:

To remove the intermediate days and date wheel, simply lift wheel out of place freeing it from the hollow stud on the plate.

B. ASSEMBLY PROCEDURE OF INTERMEDIATE DAYS AND DATE WHEEL:

Place the intermediate days and date wheel in its proper position on the plate, with the hole "A", or the larger hole in center of this wheel, over the hollow stud down in the recess in plate.

C. FUNCTION OF INTERMEDIATE DAYS AND DATE WHEEL:

The function of the intermediate days and date wheel is to rotate the intermediate days and date wheel cam. Naturally, this changes the day and date on the dial.

REFERENCE: Intermediate days and date wheel cam is Assembly No. 12.

REMARKS:

The intermediate days and date wheel makes one revolution each twenty-four hours. This is due to the intermediate days and date wheel having exactly twice the number of teeth that are on the hour wheel.

The pin "B" on the intermediate days and date wheel cam fits in the hole "B" in the intermediate days and date wheel. You will notice that the hole "B" is very large in comparison with pin "B" on the intermediate days and date wheel cam. The reason for this is that when the pin "B" on the intermediate days and date wheel cam is engaged with the teeth on the date wheel and the date wheel is manually forced to rotate, the pin "B" on the intermediate days and date wheel cam can shift in the hole "B" in the intermediate days and date wheel. This permits the date wheel to rotate without causing damage to these parts.

REFERENCE: Intermediate days and date wheel cam is Assembly 12.
Intermediate days and date wheel is Assembly 13.
Date wheel is Assembly 9.
Hour wheel is Assembly 11.

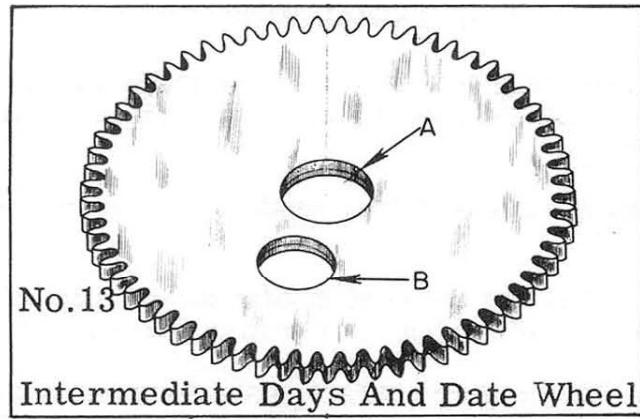

OILING

The hollow stud on which the intermediate days and date wheel pivots should be slightly moistened with oil.

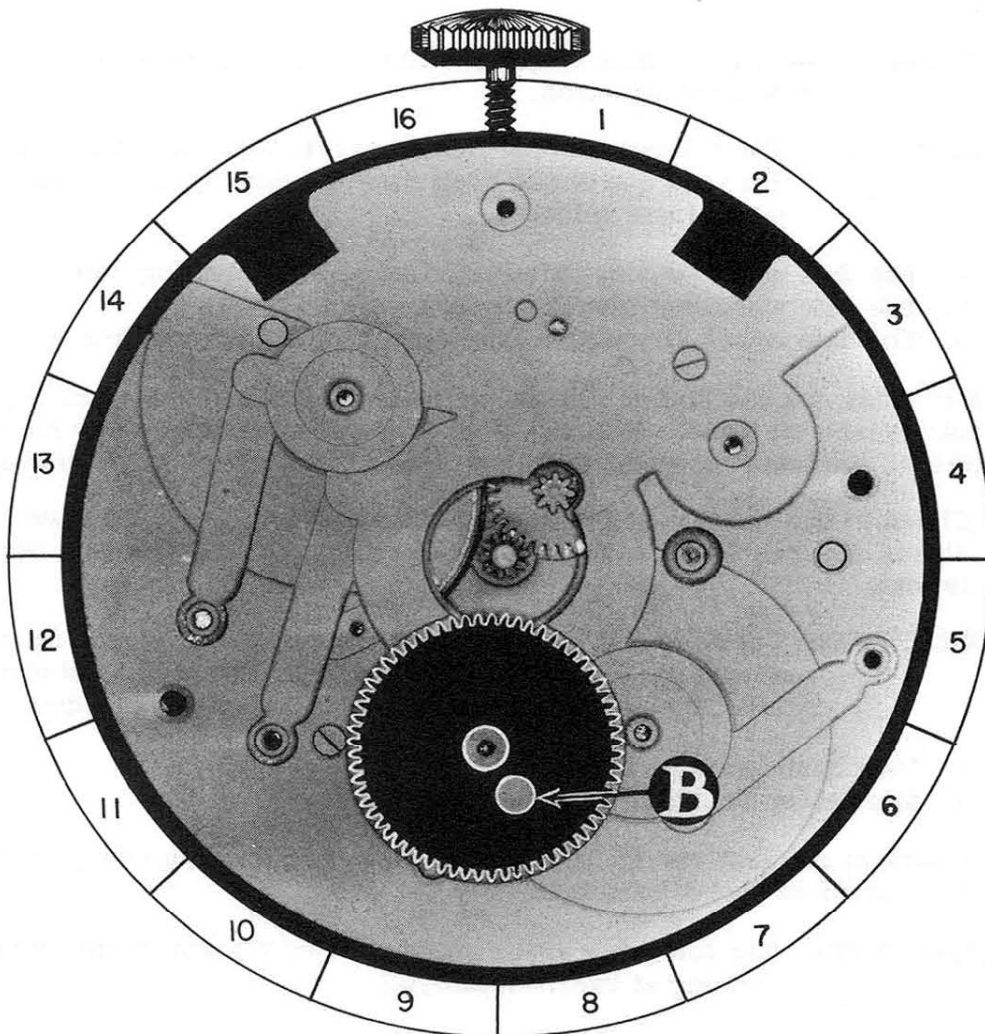

13-A

FUNCTIONAL RESULTS

After the calendograph has been completely assembled with exception of dial, hands, and bezel, place it in front of you, pendant up with dial side facing you, and check the following:

1. Push month setting button at left of pendant, release it, and check the following:

- A. Check to see that star wheel of months moves forward one space each time the months setting button is pushed and released.

CORRECTION: The following errors could prevent the star wheel of months moving forward one space each time month setting button is pushed and released:

1. Month wheel setting detent binding and not pivoting freely.
2. Star wheel of months not pivoting freely.
3. Month wheel jumper not holding enough tension on star wheel of months.

2. Push date setting button at right of pendant, release it, and check the following:

- A. Check to see that the date wheel moves forward one space each time this button is pushed and released.

CORRECTION: The following errors could prevent the date wheel moving forward one space each time the date setting button is pushed and released:

1. The date wheel setting detent binding and not pivoting freely.
2. The date wheel not pivoting freely.
3. The date wheel jumper not holding enough tension on date wheel.

3. At this point, put the dial and hands on movement and put movement in case; do not replace the bezel. Pull out stem to setting position, move hands forward until the hands are set to twelve midnight and check the following:

- A. Check to see that the red date hand advances one day. This date hand should advance to the next day each time the hour hand makes two revolutions.

CORRECTION: The following errors could prevent the date hand from advancing to the next day each time the hour hand makes two revolutions and is back to twelve o'clock midnight.

1. Date hand loose or not set correctly.
2. Minute and hour hands not set correctly.

- B. Check to see that the day of the week advances one day every twenty-four hours at twelve midnight.

CORRECTION: The following error could prevent the day of the week advancing at twelve midnight:

1. Minute and hour hand not set correctly.

This page intentionally left blank

DIRECTIONS FOR READING A CALENDAR DIAL

A DAY OF THE WEEK TRACK

The purpose of this track is to indicate the day of the week. This is done by the calendar mechanism automatically moving the day of the week track forward one space every twenty-four hours. This changes the day on the dial.

SETTING THE DAY OF THE WEEK TRACK

To set the day of the week track, pull out the winding stem and move the hands forward until the track has moved to the position to indicate the correct day on the dial.

SETTING THE CORRECT TIME

At the instant the day of the week changes to the correct day on the dial, stop turning the winding stem and observe the position of the hour hand and minute hand. They should be at twelve o'clock. This is twelve o'clock midnight. Now to set the correct time of day, you must set the hands accordingly, keeping in mind that the hands are now at twelve o'clock midnight. To be more specific, if it is before twelve o'clock noon, just set the hands to the correct time. But if it is after twelve o'clock noon, you must first turn your winding stem until the hour hand has made one revolution and is back at twelve o'clock. Then set the correct time.

B DATE TRACK

The purpose of the date track is to indicate the date on the dial. The date hand, when once set, will automatically change the date each twenty-four hours. The only time the date hand must be set manually is when setting the watch for the correct date. Also, I would like to mention that this date track is set to register thirty-one days a month, and for those months having less than thirty-one days, the correction must be made manually.

SETTING THE DATE

To set the date on the dial, press the date button with a pin, needle or some other suitable object. Then release the button. Each time this button is pressed and released, the date hand will move forward one space. When the date hand is moved to indicate the correct date, it will from then on be controlled mechanically by the calendar mechanism. The date button is located in the outside diameter of the case at the right of the pendant.

C MONTH TRACK

To set the month track manually, press the month button with a pin, needle or some other suitable object. Then release the button. This will move the month track one space causing the month to change on the dial. Continue pressing and releasing this button until the correct month appears on the dial. The month button is located in the outside diameter of the case at the left of the pendant. The month track is controlled manually.

THE CALENDAR DIAL

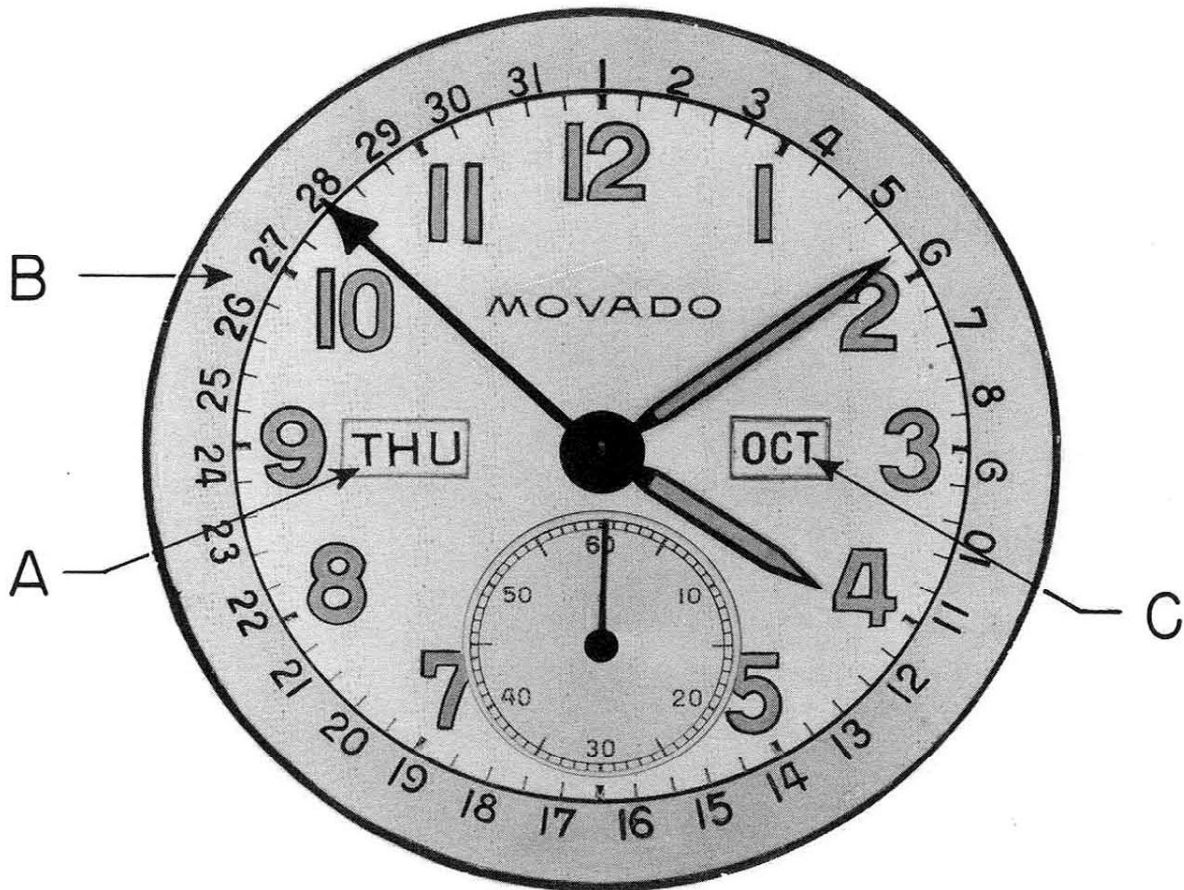

SETTING THE HANDS CORRECTLY ON A CALENDAR WATCH

Place the date hand on the date wheel with the hand pointing to 1 on the date track "B". Now pull out the winding stem placing the watch in setting position. Turn the stem until the date hand moves one space. As soon as the date hand moves one space, stop turning the stem. Then place the hour hand and minute hand exactly at 12. This is set for 12 o'clock midnight. After this is done, the second hand can now be replaced. After the hands are set, check them again carefully. Rotate the crown until the hour hand makes two revolutions and is back to 12 o'clock. Then check again to see that the date changed on the dial. When this is accomplished, your hands are set correctly. After the hands are set correctly, check the hands for spacing. The hands must be properly spaced to eliminate the hazard of one hand catching on the other, causing the watch to stop or lose time.