

WORLD'S ONLY
FULLY ILLUSTRATED
CHRONOGRAPH WATCH COURSE
VOLUME 20

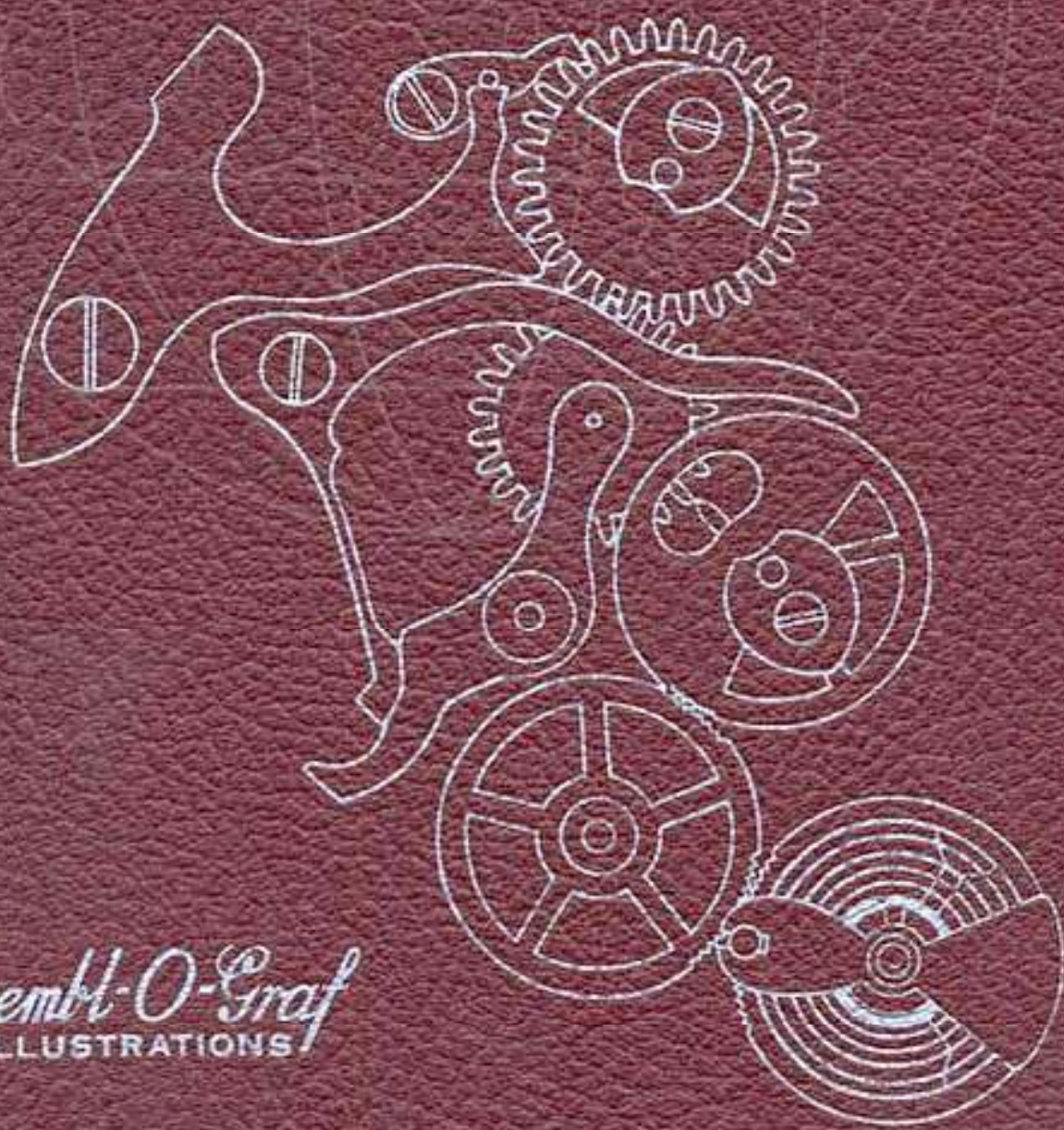

Essemb-O-Graf
ILLUSTRATIONS

IDENTIFICATION OF CHRONOGRAPH

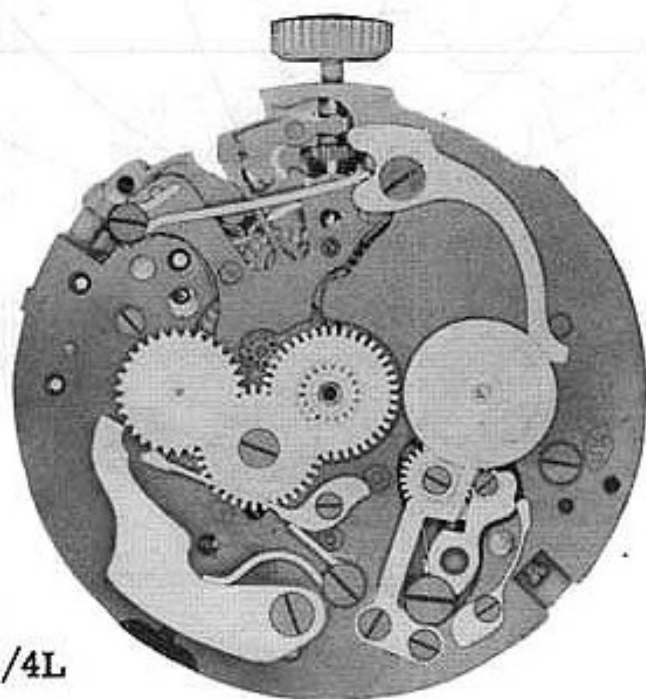

- Cal. 281 - 12L
- Cal. 381 - 12-1/4L
- Cal. 283 - 13L
- Cal. 383 - 13L
- Cal. 481 - 14-1/4L

**ALTERNATE
SETTING PARTS**



UNIVERSAL

**DATO-COMPAX
Minute Register, Hour
Register and Date Mechanism**



ESEMBL-O-GRAF

THE WORLD'S FIRST FULLY
ILLUSTRATED TEXT BOOK
ON
CHRONOGRAPH REPAIRING
AND ADJUSTING

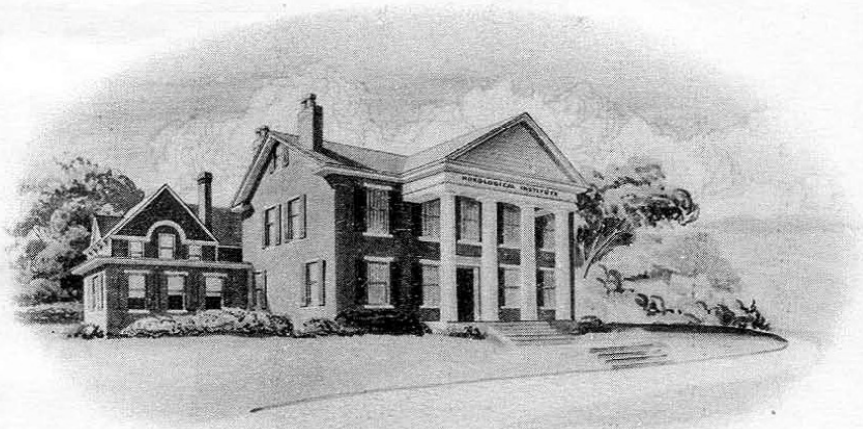

BY
William O. Smith, Sr.
PRESIDENT AND TECHNICAL DIRECTOR
AND
William O. Smith, Jr.
CHIEF ENGINEER, RESEARCH LABORATORIES

WESTERN PENNSYLVANIA HOROLOGICAL INSTITUTE, INC.
PITTSBURGH, PENNSYLVANIA

INSTRUCTIONS

For use of book

DISASSEMBLY OF THE CHRONOGRAPH MECHANISM:

1. Study the isometric drawing at top of page 1-A. The isometric drawing was made for the following purposes:

- A. It helps to identify the part to be removed.
- B. This drawing aids in pointing out certain locations on the part that are mentioned in the oiling procedure.
- C. The text refers to certain points on the part. These points are shown in the isometric drawing. This should aid you in finding the exact location on the part that is described in the text.
- D. It helps you to determine the shape of the part in case a new part has to be made.
- E. When disassembling the chronograph, each part should be carefully examined as it is removed from the movement. Each part should be checked against the isometric drawings to see that the part is the correct shape and is not broken. Each part should also be checked for any pits of rust, roughness, or burrs and for worn parts which may cause the part not to work properly.

2. At the bottom of the page 1-A is a photograph of a chronograph. In this photograph is the same part painted in black. The part is in the exact location that this part occupies in the watch. Find this location in the watch.

3. Read the disassembly procedure and the hazards in disassembly on page 1 in this book.

4. Remove this part in the same procedure as described in the text.

5. A very important item in disassembling a chronograph is keeping the screws in order, much time will be lost in putting the chronograph together if screws are mixed up. This means you have to hunt for each screw, sometimes trying three or four screws before finding the correct one. It cannot be stressed too strongly that care should be taken so that screws are not mixed up. The system that we advise for beginners, is to replace each individual screw after each part is removed. This naturally eliminates the hazard of mixing up the screws and will save you much time in the end. Do this at least until you become so thoroughly familiar with the chronograph that you no longer feel it is necessary.

6. Continue to follow this procedure throughout the book, and disassemble each part until the last part of the chronograph is removed.

ASSEMBLY OF THE CHRONOGRAPH MECHANISM:

7. When you are ready to assemble the chronograph mechanism, study the isometric drawing on the last part in this book. This drawing should aid you in identifying the part to be assembled and detecting possible defects on the part.

8. At the bottom of this page is a photograph of a chronograph. In this photograph is the same part painted in black. The part is shown in the exact location it occupies in the watch. (Continued on next page)

INSTRUCTIONS (Continued)

9. After you find the correct location for this part in the watch, read the oiling procedure for this part. The oiling procedure for this part is located underneath the isometric drawing. It is best to read the oiling procedure before you put each part in place, as there are certain parts that must be oiled immediately, as it may prove difficult to oil them later.

10. Read the assembly procedure and the hazards in assembling for the last part in this book.

11. Replace the part in its exact location, as shown in photograph, using the procedure as described in the text.

12. Replace the screw that holds this part in place. Of course, the screws should be kept in order as we advised above, but if the screws are not in order or the watch was received with screws mixed up, you will find a screw drawn for each part that requires a screw, at the bottom of the text page.

13. After replacing this part, replace the next part, etc., until the last part is replaced, which will be part No. 1. For replacing each part, use the procedure as described in the text.

(Note: the assembly of the chronograph is exactly the reverse of the disassembly.)

14. After the chronograph mechanism is assembled, read the functions of the different parts in the mechanism. This should help you to understand more fully the purpose of each part and how it works in conjunction with the other parts. It is to your advantage also to read the function before assembling each part, as many mistakes can be prevented when the assembling is done with an understanding of the function.

15. Read the text on adjustment of eccentric studs. This text should be read with reference to the eccentric stud picture. Now adjust each eccentric stud, one at a time, in the watch, as described in the text. Use the picture to find the position of these studs.

16. Study the text on functional results in this book, and check the chronograph mechanism as described in this text.

NOMENCLATURE OF PARTS FOR CHRONOGRAPH MECHANISM

17. After you have become thoroughly familiar with the chronograph mechanism you can disassemble and assemble the chronograph by using the nomenclature of parts as a guide. This makes it possible for you to use a procedure without going through each page in the book.

18. On each page in this book, the part number and the page number are the same. This makes it convenient for the reader and eliminates any confusion.

IDENTIFYING A CHRONOGRAPH OR STOP WATCH

The chronograph and stop watch are very similar in appearance in many respects, but there is a difference which will enable you to distinguish the chronograph from the stop watch.

The chronograph is a watch having at least one supplementary hand in addition to the regular hour, minute, and second hand which can be started, stopped or returned to zero at will. Thus the chronograph can be used as a regular timekeeping watch and may also be used in registering observations.

The stop watch is a watch which has only the necessary hands to register an observation, the hour, minute, and seconds hand being omitted. The stop watch is not used to indicate the time of day, but only to register the length of observations.















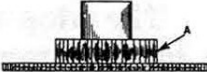

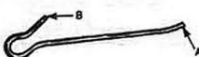
The stop watch is divided into two categories, the stop watch in which the balance wheel is continually in motion and the stop watch in which the balance wheel is in motion only during the actual timing of observations.

The advantage in the latter type is that the watch is running only during the actual timing operation. Thus there is less wear to the stop watch and the mainspring does not have to be wound so often. This is especially true in the stop watch which has a very rapid oscillation of the balance. The stop watch by altering the hairspring and balance wheel to increase the oscillation of the balance can be made to register $1/30$, $1/50$, or even $1/100$ of a second. This increase in the oscillation of the balance in the stop watch is possible because the balance wheel is in motion only during the actual timing operation and the watch does not indicate the time of day.

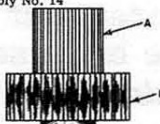
The chronograph is designed to register the time correct to $1/5$ of a second. It would be difficult to make a chronograph register correctly to less than $1/5$ of a second, as the rapid oscillation of the balance would require too large a mainspring to run the watch for a twenty-four hour period, and the hour and minute hand would have to be geared down tremendously to keep the correct time.

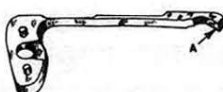



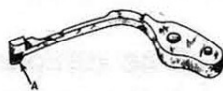





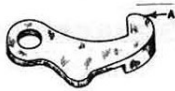

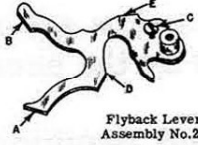

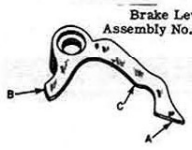

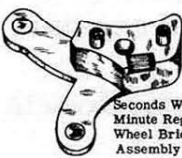
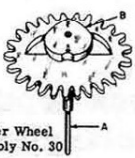
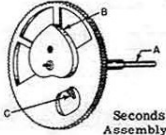

The chronograph usually embodies the basic principles by which the stop watch performs its function, and to anyone familiar with the functions of the various parts of a chronograph should have no trouble understanding stop watch mechanism.

NOMENCLATURE OF PARTS FOR CHRONOGRAPH MECHANISM

 Date Wheel Setting Detent Spring Assembly No.1	 Date Wheel Setting Detent Lever Assembly No. 2	 Date Wheel Assembly No. 3
 Date Wheel Pawl Assembly No. 4	Intermediate Date Wheel  Assembly No. 5	 Hour Wheel With Hairing Wheel Assembly No. 6
 Hour Register Wheel Tension Spring Assembly No. 7	 Hour Register Wheel Assembly No.8	 Hour Flyback Spring Assembly No. 9
 Hour Flyback Lever Assembly No. 10	 Hour Pivoted Detent Spring Assembly No. 11	 Intermediary Hour Wheel Assembly No. 12
 Hour Pivoted Detent Assembly No.13	Assembly No. 14  Transmission Pinion	 Wheel Over Fourth Wheel Assembly No.15
 Minute Register Pawl Assembly No. 16	 Chronograph Pivoted Detent Spring Assembly No. 17	 Chronograph Pivoted Detent Bridge Assembly No. 18
 Intermediary Wheel Assembly No. 19	 Chronograph Pivoted Detent Assembly No. 20	 Actuating Detent Lever Spring Assembly No. 21

Continued on next page

NOMENCLATURE OF PARTS FOR CHRONOGRAPH MECHANISM

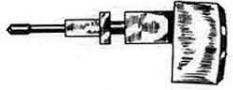
 <p>Joint Hook Assembly No. 22</p>	 <p>Actuating Detent Lever Assembly No. 23</p>	 <p>Flyback Lever Assembly No. 24</p>
 <p>Flyback Lever Spring Assembly No. 25</p>	 <p>Brake Lever Spring Assembly No. 26</p>	 <p>Brake Lever Assembly No. 27</p>
 <p>Push Piece for Setting Back to Zero Assembly No. 28</p>	 <p>Seconds Wheel & Minute Register Wheel Bridge Assembly No. 29</p>	 <p>Minute Register Wheel Assembly No. 30</p>
 <p>Seconds Wheel Assembly No. 31</p>	 <p>Seconds Wheel Tension Spring Assembly No. 32</p>	 <p>Intermittent Lever Spring Assembly No. 33</p>
 <p>Intermittent Lever and Wheel Assembly No. 34</p>	 <p>Intermittent Wheel Assembly No. 34-B</p>	 <p>Castle Wheel Pawl Assembly No. 35</p>
 <p>Date Pusher</p>	 <p>Sweep Second Hand</p>	 <p>Date Hand</p>
 <p>Minute Register Hand</p>	 <p>Hour Register Hand</p>	 <p>Chronograph Button</p>
 <p>Chronograph Button</p>		

ADJUSTING ECCENTRIC STUDS

Things to Check

Listed below are a number of depthings and adjustments controlled by the eccentric studs:

1. Check depthing of intermittent wheel teeth with seconds wheel dart tooth.

CORRECTION: If this depthing is incorrect, it can be corrected by adjusting eccentric stud ES-1.

REFERENCE: Intermittent wheel is Assembly 34-A.
Seconds wheel dart tooth is Assembly 31-C.

2. Check depthing of wheel over fourth wheel teeth with intermediary wheel teeth.

CORRECTION: If this depthing is incorrect, it can be corrected by adjusting eccentric stud ES-3.

REFERENCE: Wheel over fourth wheel is Assembly 15.
Intermediary wheel is Assembly 19.

3. Check depthing of intermediary wheel teeth with seconds wheel teeth.

CORRECTION: If this depthing is incorrect, it can be corrected by adjusting eccentric stud ES-2.

REFERENCE: Intermediary wheel is Assembly 19.
Seconds wheel is Assembly 31.

NOTICE

On the dial side of this chronograph, there are no eccentric studs.

ADJUSTING ECCENTRIC STUDS

DO NOT REMOVE THESE STUDS

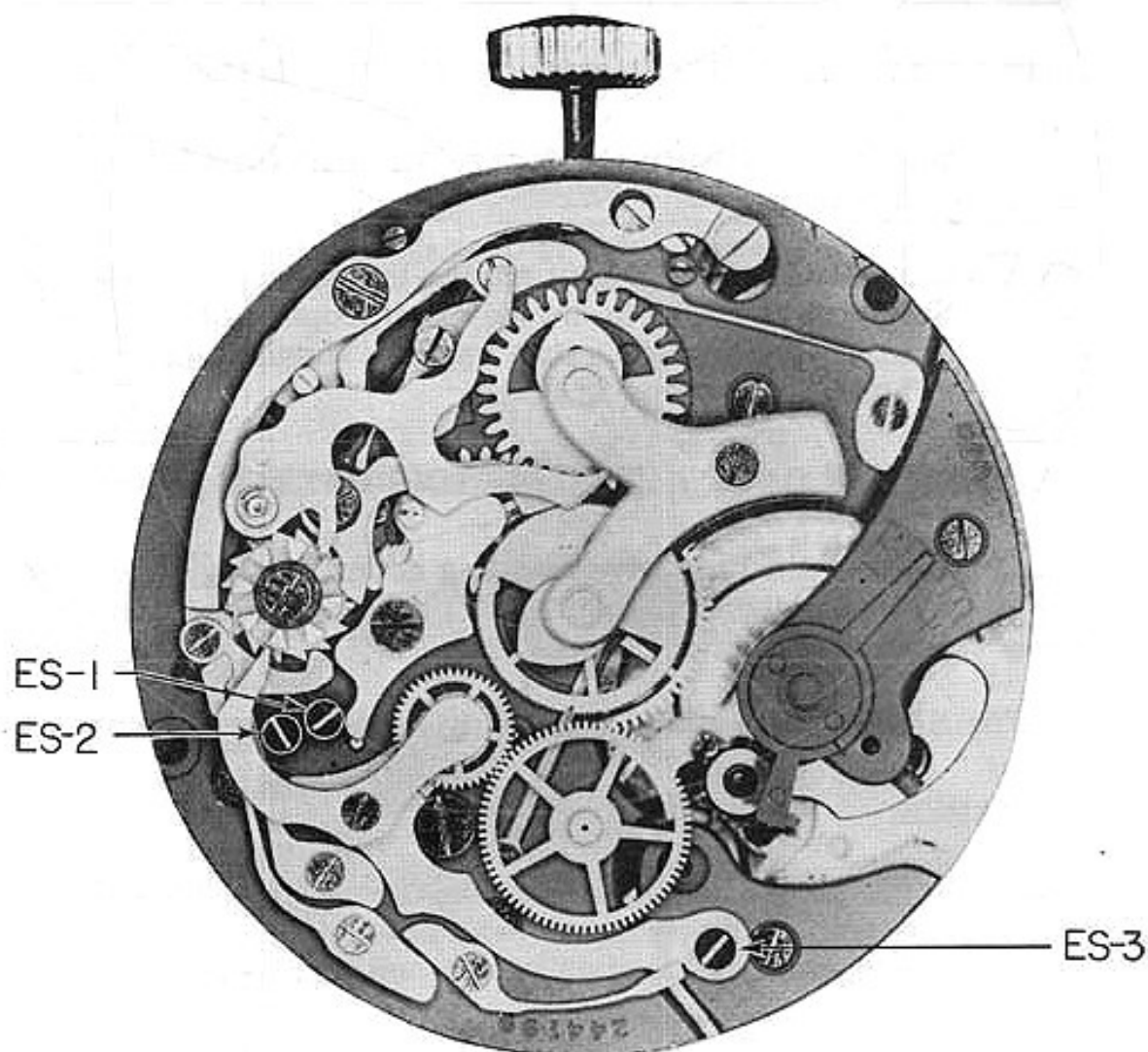

CAUTION

In disassembling or assembling chronograph it is a good policy not to turn eccentric studs. These eccentric studs are used to adjust one part to another and naturally in turning these studs you will lose the desired adjustment of the chronograph mechanism which will cause the chronograph to function incorrectly. Another reason for not turning these studs unless it is necessary is that they soon become loose and will not hold the desired adjustment.

PART NO. 1

A. DISASSEMBLY PROCEDURE OF DATE WHEEL SETTING DETENT SPRING:

This spring is held in place by shouldered screw SS-1. When this screw is removed, the detent spring will be free on the plate and can be lifted out of place.

(The shape of screw for this part is shown at bottom of page)

B. ASSEMBLY PROCEDURE OF DATE WHEEL SETTING DETENT SPRING:

Place date wheel setting detent spring in its proper position on the plate with the loop in spring over proper hole in plate as shown in the photograph. Now replace shouldered screw SS-1 that holds this spring in place.

C. FUNCTION OF DATE WHEEL SETTING DETENT SPRING:

The function of the date wheel setting detent spring is to hold the date wheel setting detent lever in a negative position away from the center of the watch.

REFERENCE: Date wheel setting detent lever is Assembly 2.

REMARKS:

The first six parts to be removed are the parts of the calendar mechanism. This mechanism is completely independent of the chronograph mechanism or the hour register mechanism.

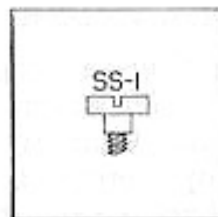

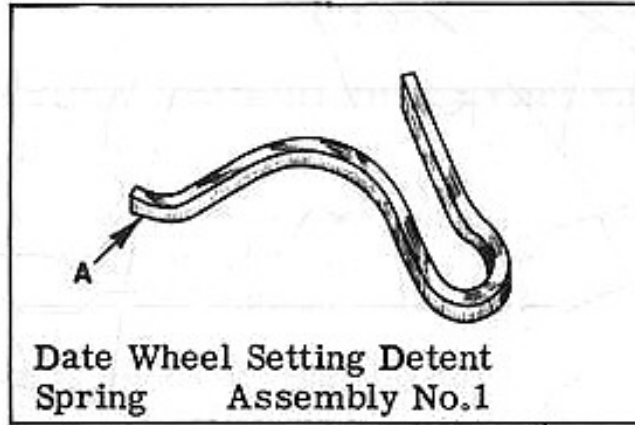

OILING

End "A" of date wheel setting detent spring should be slightly moistened with oil at point of contact with date wheel setting detent lever.

DIAL SIDE

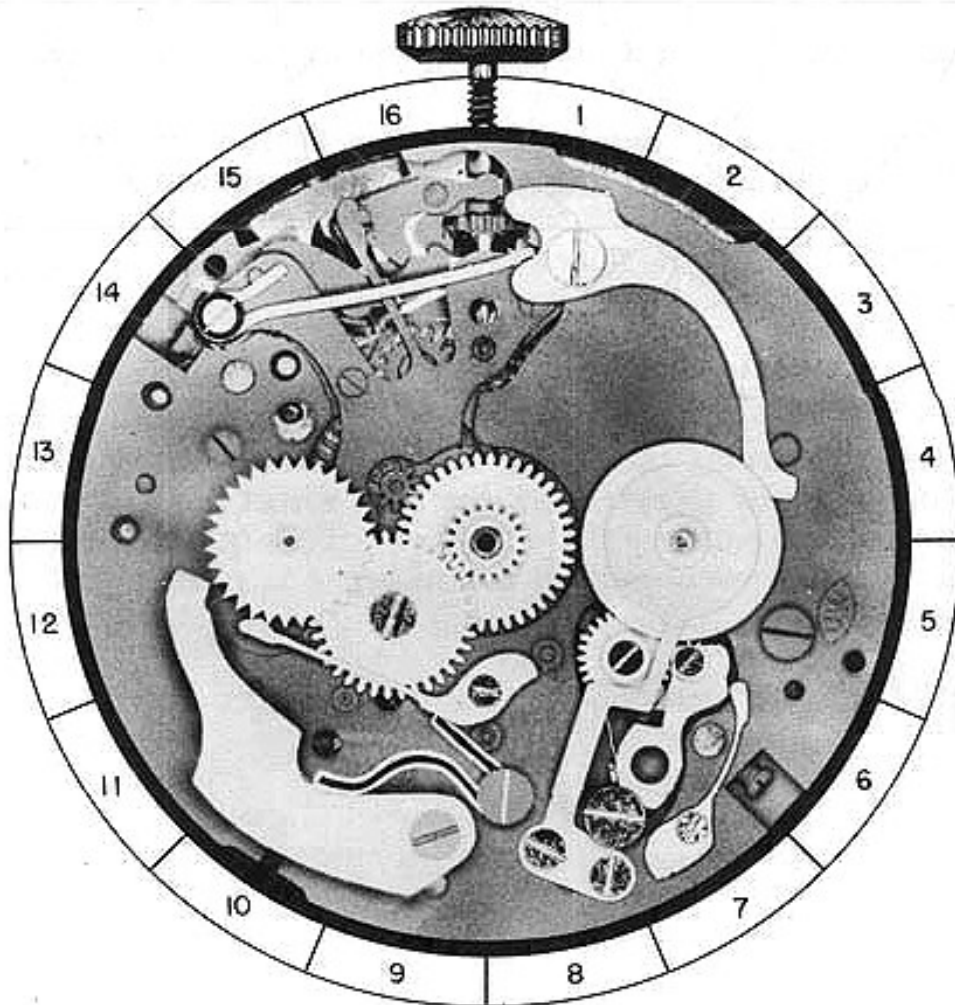

1-A

A. DISASSEMBLY PROCEDURE OF DATE WHEEL SETTING DETENT LEVER:

This lever is held in place by shouldered screw SS-2. When this screw is removed, the setting detent lever is free on the plate and can be lifted out of place.

(The shape of screw for this part is shown at bottom of page.)

B. ASSEMBLY PROCEDURE OF DATE WHEEL SETTING DETENT LEVER:

Place the date wheel setting detent lever in its proper position on the plate as shown in the photograph. Now replace shouldered screw SS-2. After shouldered screw SS-2 is replaced, check this detent lever to see that it pivots freely under the head of this screw.

C. FUNCTION OF DATE WHEEL SETTING DETENT LEVER:

The function of the date wheel setting detent lever is, each time it is pushed, to move the date wheel forward one tooth.

REFERENCE: Date wheel is Assembly 3.

REMARKS:

When this detent lever is pushed, it contacts a tooth on the date wheel forcing the date wheel to rotate slightly. When the detent lever is released, the date wheel pawl forces the date wheel to rotate a little further. This is repeated each time the date wheel setting detent lever is pushed and released.

REFERENCE: Date wheel pawl is Assembly 4.

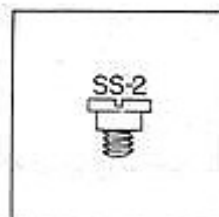

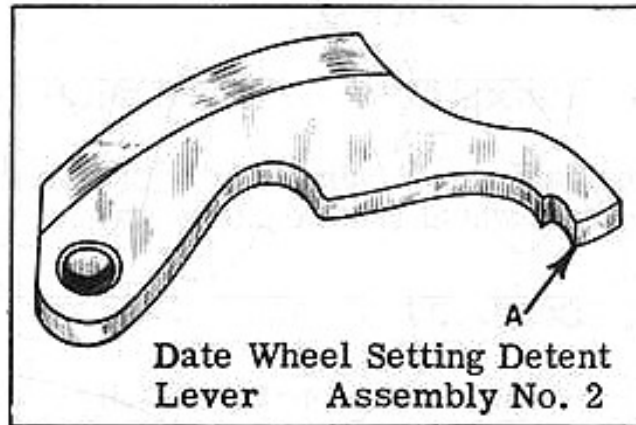

OILING

The shoulder of screw on which the date wheel setting detent lever pivots should be slightly moistened with oil.

DIAL SIDE

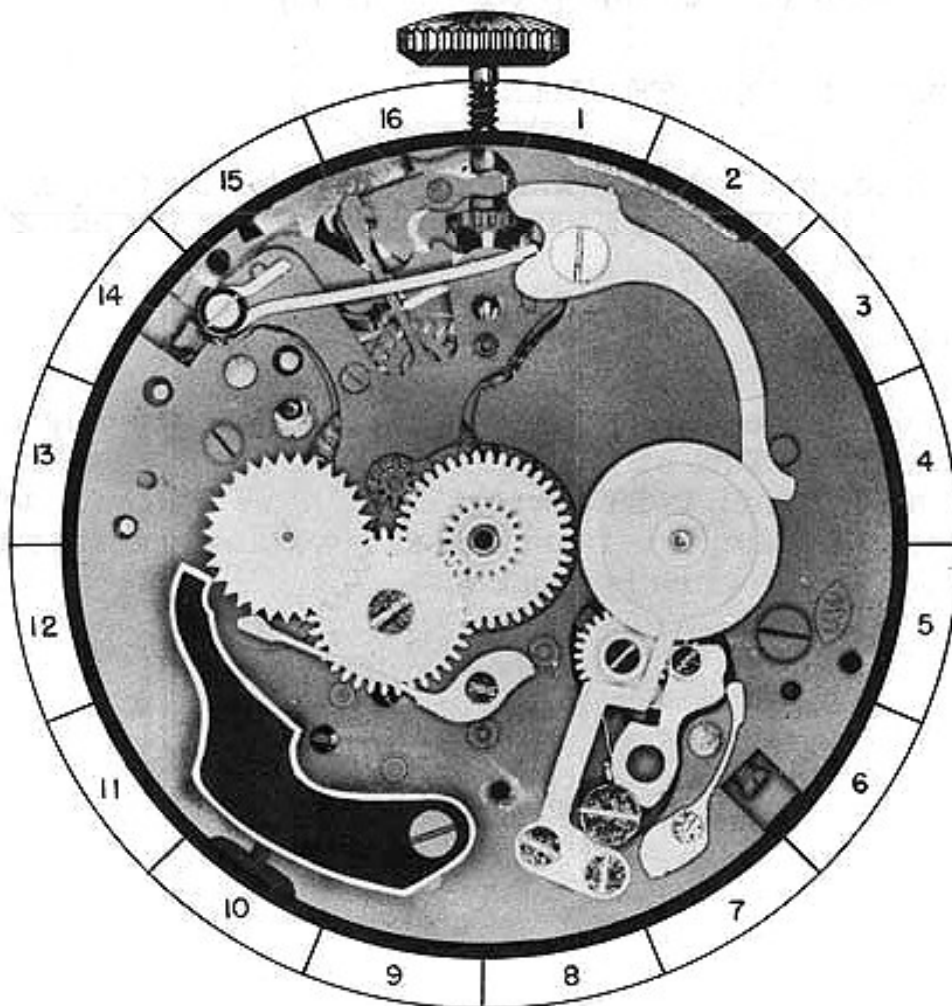

2-A

A. DISASSEMBLY PROCEDURE OF DATE WHEEL:

To remove the date wheel, simply lift straight up on date wheel freeing date wheel from post on plate.

B. ASSEMBLY PROCEDURE OF DATE WHEEL:

Place the date wheel in its proper position on the plate with the hole in date wheel over post on plate. Now press date wheel down to proper place until the teeth of date wheel rest on top of the date wheel pawl. Now move the end "A" of date wheel pawl away from the center of the watch slightly to clear the teeth so that the date wheel can be pressed down to proper place. The end "A" of date wheel pawl should mesh in between two teeth on the date wheel.

REFERENCE: Date wheel pawl is Assembly 4.

C. FUNCTION OF DATE WHEEL:

The function of the date wheel is to register the date on the dial. This is done by a hand being attached to the long tube on this wheel.

REMARKS:

This date wheel is controlled mechanically by the calendar mechanism. This wheel is also controlled manually for setting the watch to the correct date. After it is once set for the correct date, it is from then on controlled mechanically, as long as the watch is running.

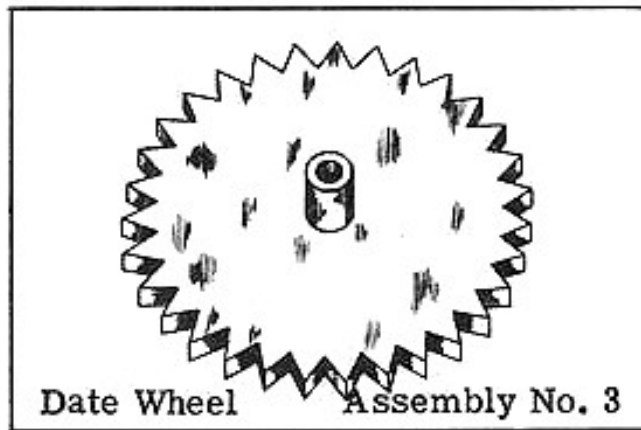

OILING

The date wheel should not be oiled.

DIAL SIDE

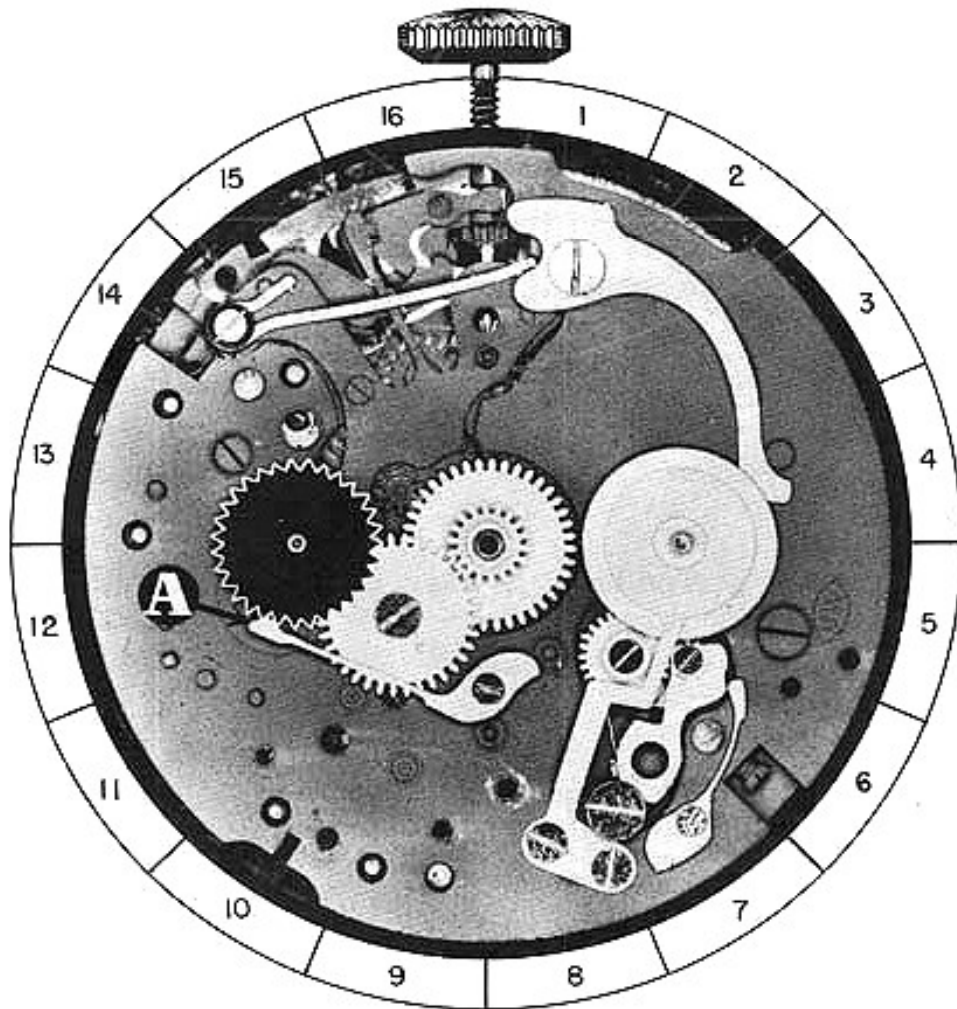

3-A

A. DISASSEMBLY PROCEDURE OF DATE WHEEL PAWL:

The date wheel pawl is held in place by beveled countersink screw BS-1 and steady pins. When this screw is removed, pawl can be loosened from the plate by sliding a thin blade screwdriver between pawl and plate. After steady pins are free in plate, pawl can be lifted out of place.

(The shape of screw for this part is shown at bottom of page.)

B. ASSEMBLY PROCEDURE OF DATE WHEEL PAWL:

Place the date wheel pawl in its proper position as shown in the photograph. Make sure that steady pins on pawl are entering the proper holes in the plate. Now press pawl down to proper place and replace beveled countersink screw BS-1.

C. FUNCTION OF DATE WHEEL PAWL:

The function of the date wheel pawl is to do two things:

1. The date wheel pawl correctly spaces the turning of the date wheel.
2. The date wheel pawl holds the date wheel in its proper position so that a bump or jar cannot alter the position of this wheel.

REFERENCE: Date wheel is Assembly 3.

REMARKS:

The end of this pawl must be highly polished and free from pits of rust. Any roughness at this location will cause the pawl not to function properly.

The amount of tension the date wheel pawl holds on date wheel should be only strong enough to perform its function as described above. Too strong a tension on date wheel may cause the watch to stop.



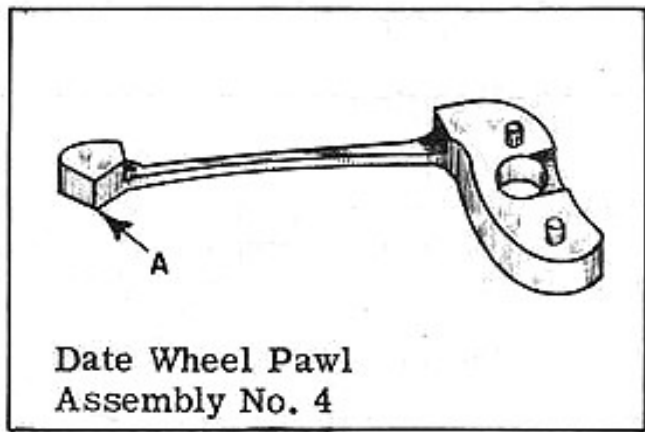

OILING

The date wheel pawl should not be oiled.

DIAL SIDE

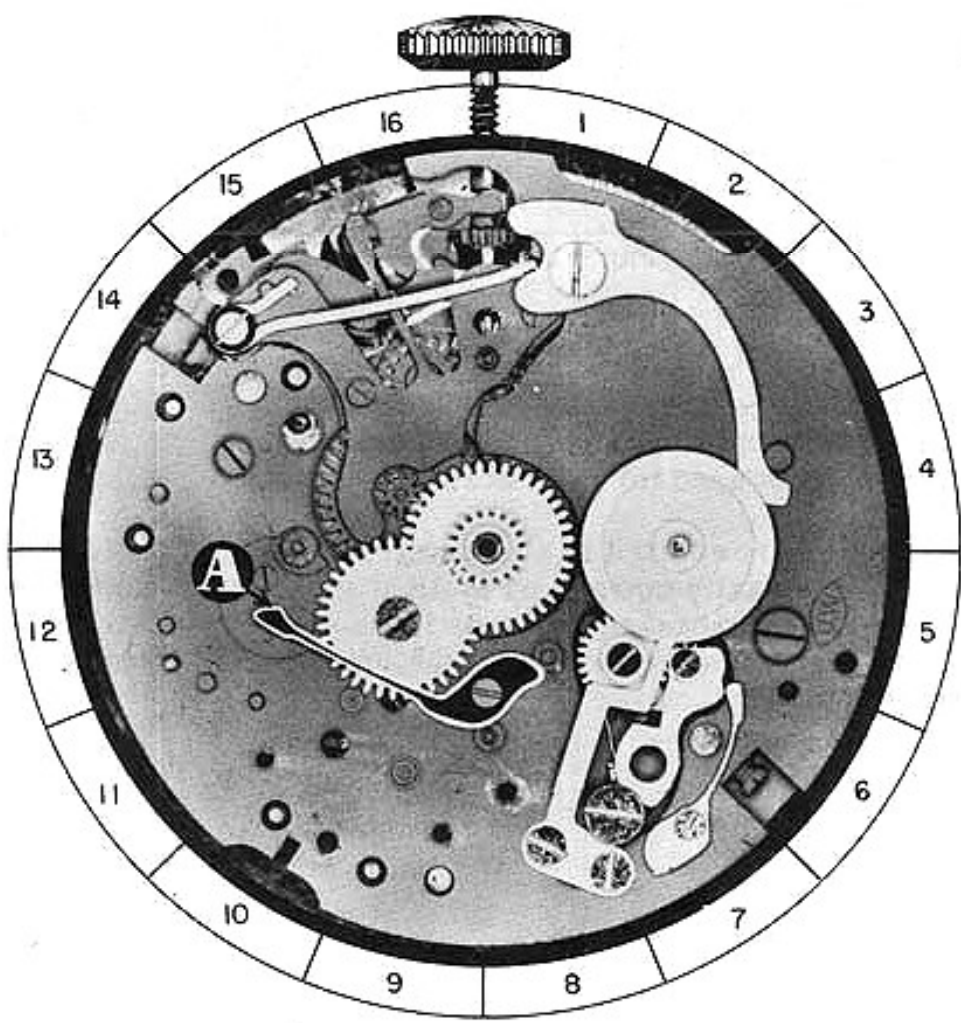

4-A

A. DISASSEMBLY PROCEDURE OF INTERMEDIATE DATE WHEEL:

The intermediate date wheel is held in place by shouldered screw SS-3. When this screw is removed, the date wheel will be free on the plate and can be lifted out of place.

(The shape of screw for this part is shown at bottom of page.)

B. ASSEMBLY PROCEDURE OF INTERMEDIATE DATE WHEEL:

Place the intermediate date wheel in its proper position on the plate as shown in the photograph. Now replace shouldered screw SS-3. After this screw is replaced, check the intermediate date wheel to see that it pivots freely under the head of this screw.

C. FUNCTION OF INTERMEDIATE DATE WHEEL:

The function of the intermediate date wheel is to move the date wheel one tooth each twenty-four hours. This is done by pin "A" on the intermediate date wheel engaging with the date wheel teeth and moving date wheel one tooth each time the intermediate date wheel makes one revolution.

REFERENCE: Date wheel is Assembly 3.

REMARKS:

When repairing a chronograph, it is most important that screwdrivers are properly sharpened and the correct size of screwdriver blade is used for each screw slot.

Most of the screws used in a chronograph are highly polished and are very easily marred by a slight slip of the screwdriver. To repair a chronograph and have these screw heads marred indicates carelessness, either in the sharpening or use of the screwdriver.

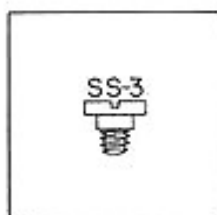

Intermediate Date Wheel

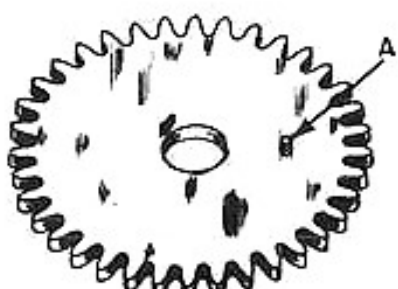

Assembly No. 5

OILING

The intermediate date wheel should not be oiled.

DIAL SIDE

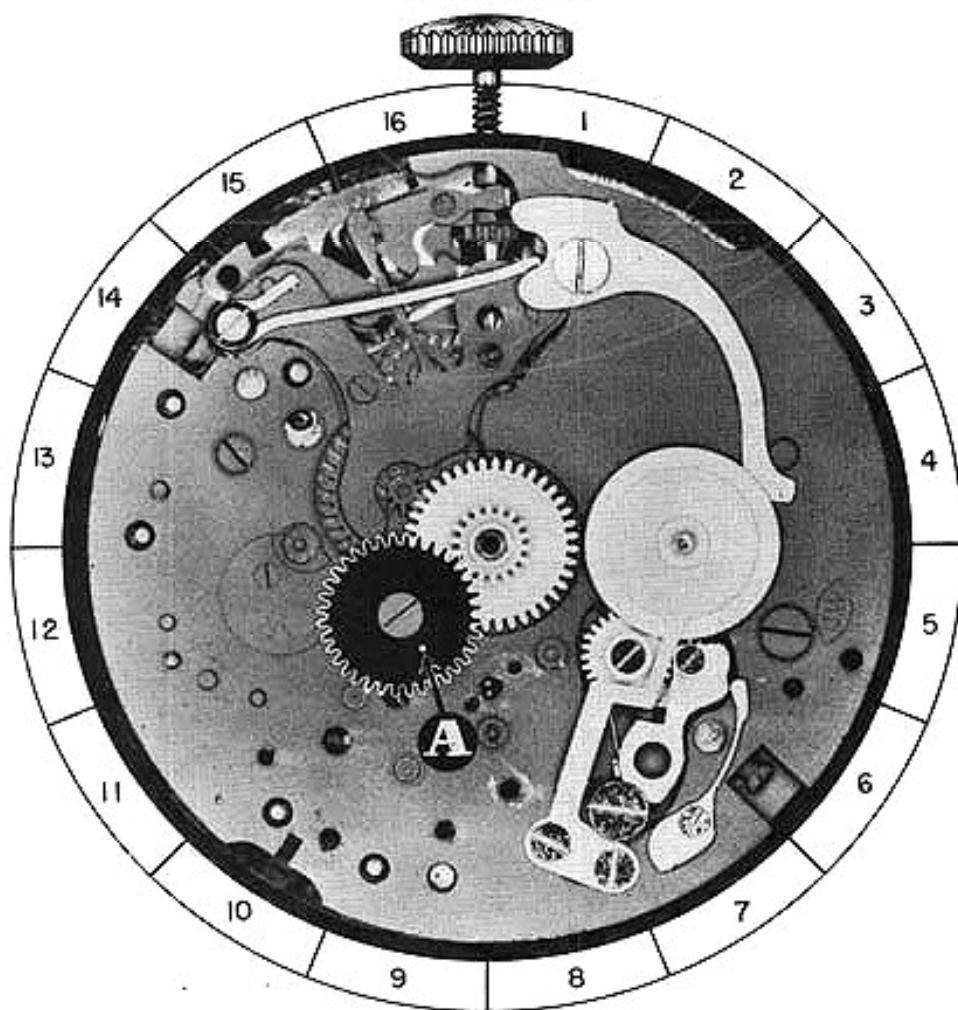

5-A

A. DISASSEMBLY PROCEDURE OF HOUR WHEEL WITH HAIRING WHEEL:

To remove the hour wheel with hairing wheel, simply lift straight up on wheel freeing wheel from the cannon pinion. The removal of this part completes the disassembly of the calendar mechanism.

B. ASSEMBLY PROCEDURE OF HOUR WHEEL WITH HAIRING WHEEL:

Place the hour wheel with hairing wheel in its proper position with the hour wheel over the cannon pinion as shown in the photograph. Now press wheel down to proper place until the teeth on the hour wheel with hairing wheel mesh into the pinion on intermediate minute wheel.

C. FUNCTION OF HOUR WHEEL WITH HAIRING WHEEL:

The hour wheel with hairing wheel performs its functions of an ordinary hour wheel in watch. Also the hairing wheel "A" transfers the power to the calendar mechanism.

REMARKS:

The calendar mechanism changes the date automatically each day; of course, this mechanism, as in mostly all calendar mechanisms, will not always change the date correctly on the first day of each month.

The date will only change correctly if the previous month has thirty-one days, but if the previous month had only thirty days or less, then the date would not change correctly. In this case you must correctly set the date manually on the first of the month.

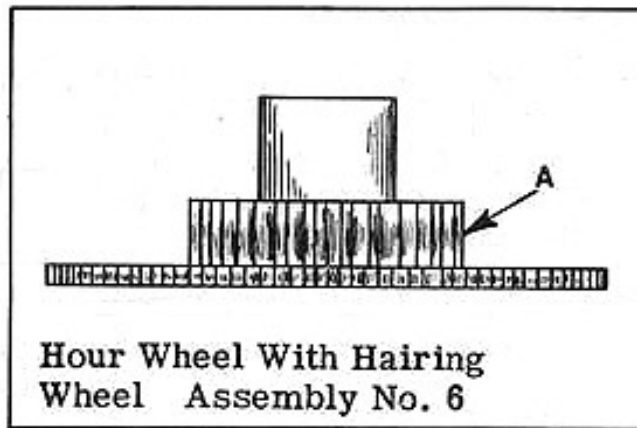

OILING

The hour wheel with hairing wheel should not be oiled.

DIAL SIDE

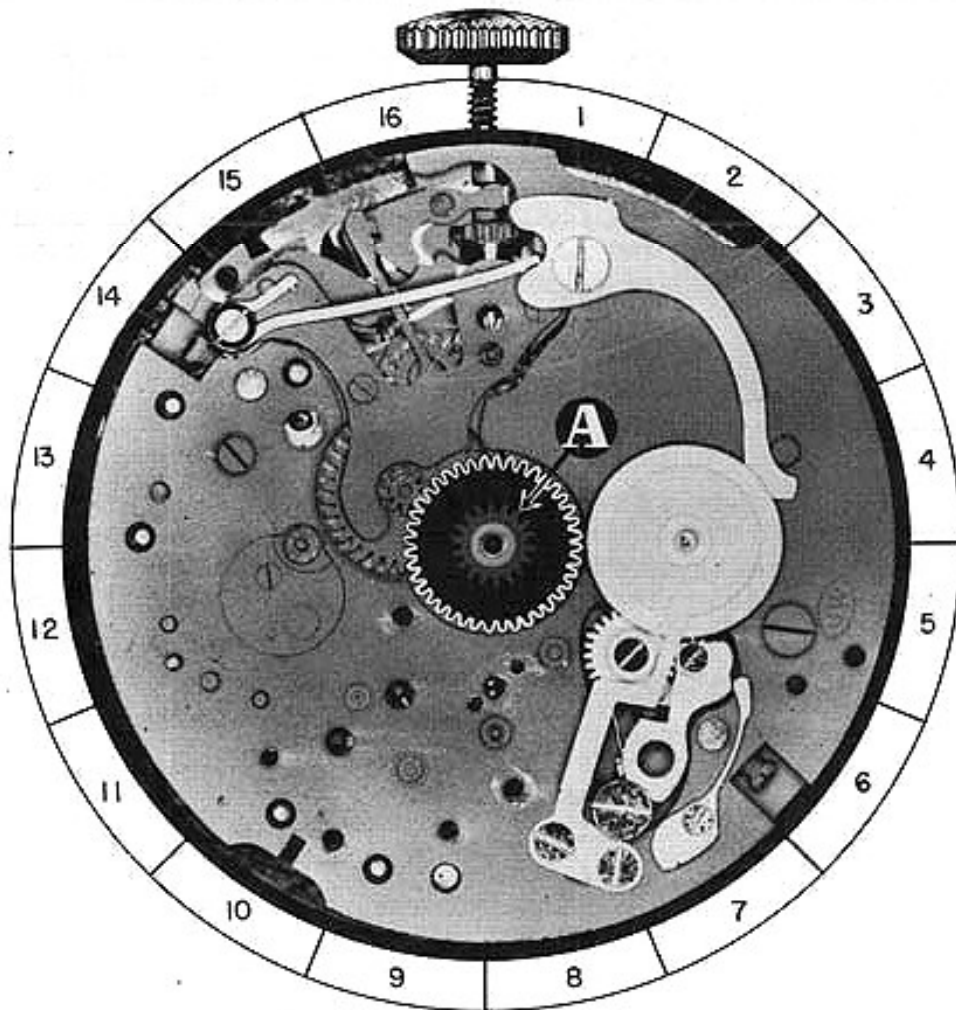

6-A

A. DISASSEMBLY PROCEDURE OF HOUR REGISTER WHEEL TENSION SPRING:

This tension spring is held in place by fillister head screws FS-1 and FS-2. When these screws are removed, this tension spring can be lifted out of place with a pair of tweezers.

(The shape of screws for this part is shown at bottom of page.)

B. ASSEMBLY PROCEDURE OF HOUR REGISTER WHEEL TENSION SPRING:

Place this tension spring in its proper position on the plate as shown in the photograph. The hole "A" in tension spring must fit over the hour register wheel. After spring is in its proper position, replace fillister head screws FS-1 and FS-2 that hold this spring in place.

C. FUNCTION OF HOUR REGISTER WHEEL TENSION SPRING:

The function of the hour register wheel tension spring is to do three things:

1. The tension spring holds a tension on the hour register wheel. This tension holds the hour register wheel stationary when the hour register wheel is disengaged from the hour register mechanism.
2. The hour register wheel tension spring holds the hour register wheel down in place preventing it from riding up on post and coming out of place.
3. The hour register wheel tension spring holds a tension on the hour register wheel, preventing any lost motion between the pinion on intermediary hour wheel and the hour register wheel. This allows for smooth even turning of the hour register wheel.

REFERENCE: Intermediary hour wheel is Assembly No. 12.
Hour register wheel is Assembly No. 8.

REMARKS:

The hour register wheel tension spring should hold a strong enough tension on hour register wheel to perform its function as described above. Any excess tension will cause a drag on the train of the watch which may cause the watch to stop before the watch runs down. Consequently, the watch may only run a period of twenty hours or so instead of the prescribed length of time.

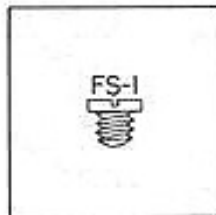

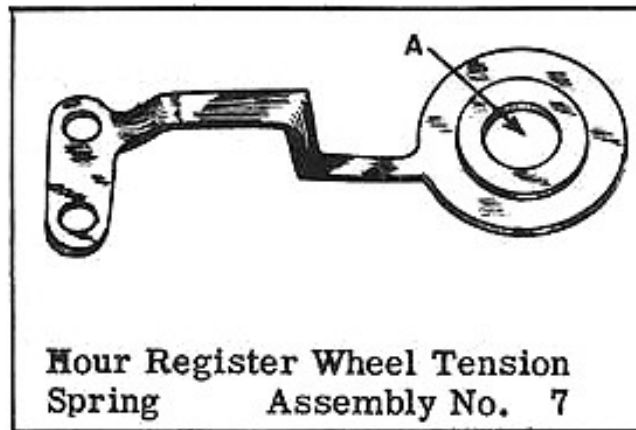

OILING

The hour register wheel tension spring should not be oiled.

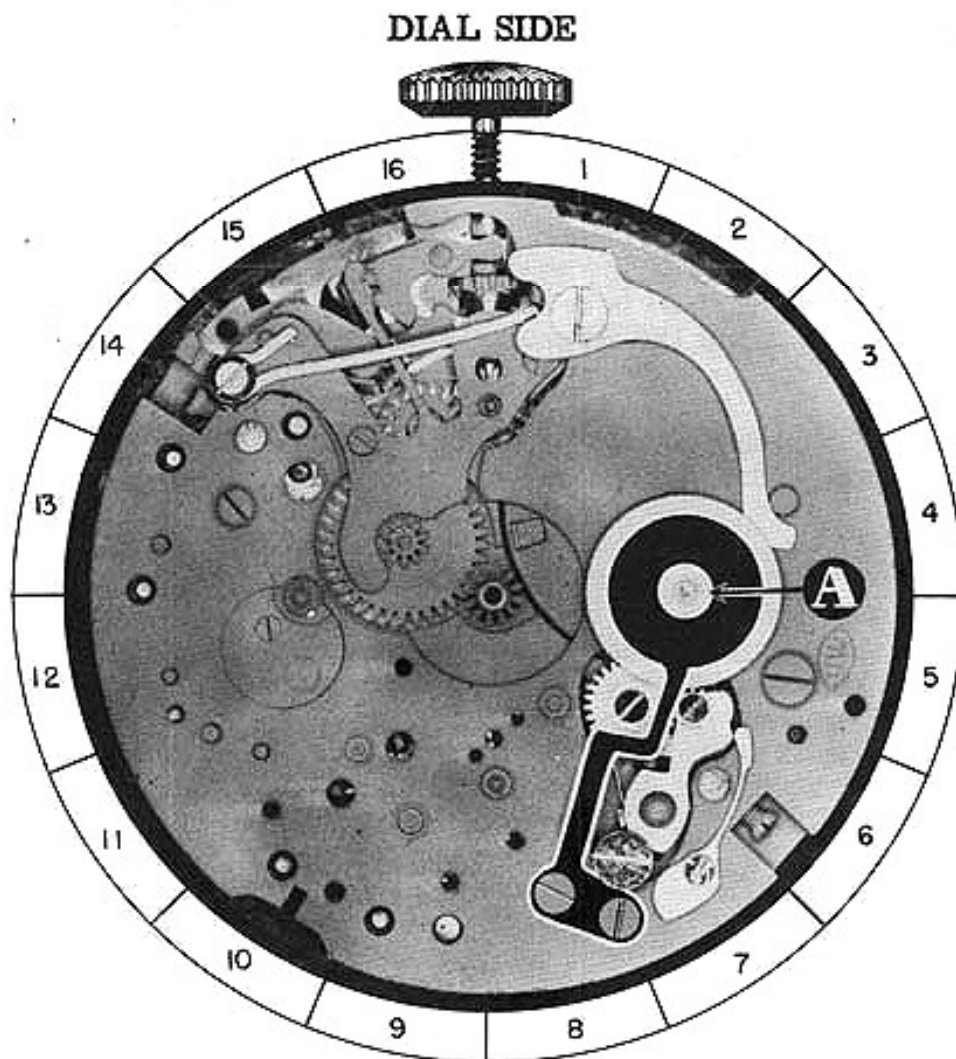

7-A

A. DISASSEMBLY PROCEDURE OF HOUR REGISTER WHEEL:

To remove this wheel, grip tube "A" with a pair of tweezers and lift straight up on tube freeing wheel from post on the plate.

B. ASSEMBLY PROCEDURE OF HOUR REGISTER WHEEL:

Place this wheel in its proper position on the plate with the hollow tube "A" in wheel over post on plate. Now press wheel down to proper place.

C. FUNCTION OF HOUR REGISTER WHEEL:

The function of the hour register wheel is to do two things:

1. It registers the passage of hours since the beginning of the registration of the chronograph mechanism. This is done by a hand being attached to tube "A" on the hour register wheel.
2. It returns to a zero position. This is done by the hour flyback lever contacting the heart "B" on the hour register wheel, forcing the wheel and hand connected to this wheel to a zero position.

REFERENCE: Hour flyback lever is Assembly 10.

REMARKS:

The hour register wheel is returned to a zero position by the flyback lever contacting the eccentric heart "B" on hour register wheel. When the hour flyback lever contacts the eccentric heart, it forces the heart to turn until the flat end of flyback lever sets across the two lobes at top of heart. With the pressure equalized at these two points, it would turn no further and this would be a zero position.

If this wheel has turned less than 160 degrees from the zero position when the flyback lever is in contact with the heart, it will turn in the opposite direction to which it was turning to bring the wheel back to a zero position. On the other hand, if the wheel is turned passed 160 degrees from the zero position, the flyback lever, when brought in contact with the hour register heart, forces it to continue to turn in the direction it was turning until it reaches a zero position.

The degree used above should not be taken as exactly correct, as it is approximate. This degree varies in most chronographs from 150 to 170 degrees.

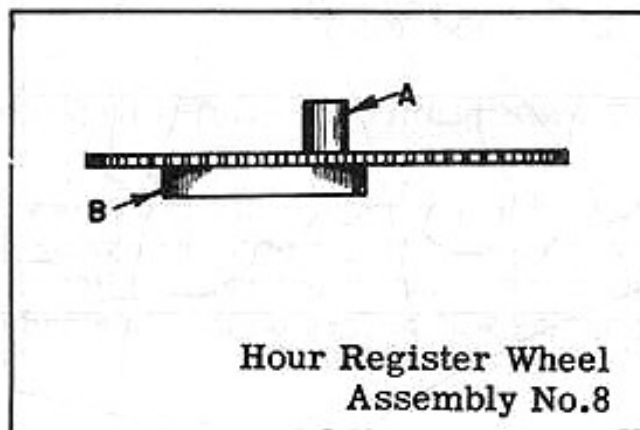

OILING

The post in plate on which the hour register wheel pivots should be slightly moistened with oil.

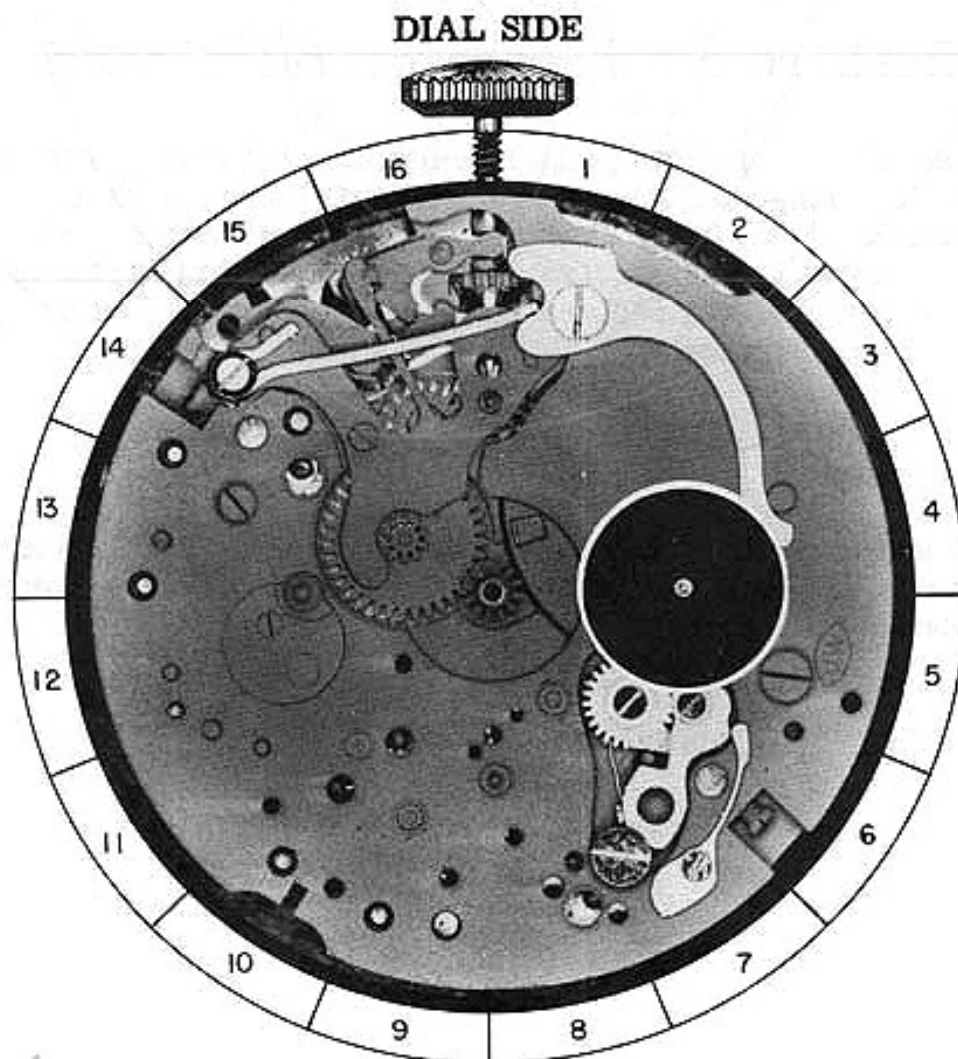

8-A

A. DISASSEMBLY PROCEDURE OF HOUR FLYBACK SPRING:

This spring is held in place by shouldered screw SS-4. When removing this screw hold finger over the spring so that the spring and the screw cannot shoot away. After this screw is removed, the spring will be free on the plate and can be lifted out of place.

(The shape of screw for this part is shown at bottom of page.)

B. HAZARDS IN DISASSEMBLY OF HOUR FLYBACK SPRING:

Hold finger over spring when removing screw so that the screw cannot possibly shoot away and be lost.

C. ASSEMBLY PROCEDURE OF HOUR FLYBACK SPRING:

Place the spring in its proper position on the plate. The end "B" of spring should contact the pin "D" on the setting bridge as shown in the photograph. The end "A" of spring should contact the hour flyback lever. After this spring is in its proper position, replace shouldered screw SS-4 that holds this spring in place.

D. FUNCTION OF HOUR FLYBACK SPRING:

The hour flyback spring holds a tension on the hour flyback lever forcing end "A" of hour flyback lever away from the center of the watch.

REFERENCE: Hour flyback lever is Assembly 10.



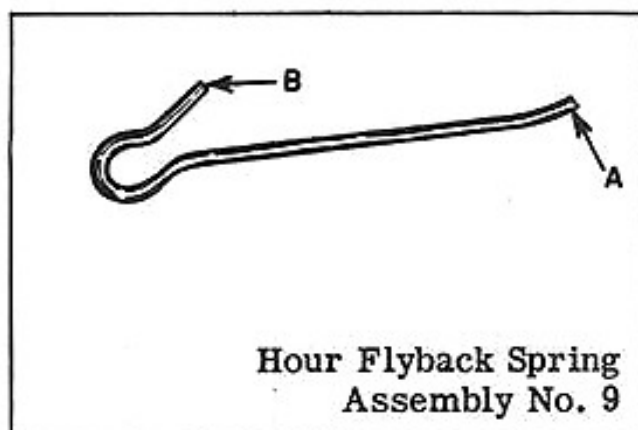

OILING

End "A" of hour flyback spring should be slightly moistened with oil at point of contact with hour flyback lever.

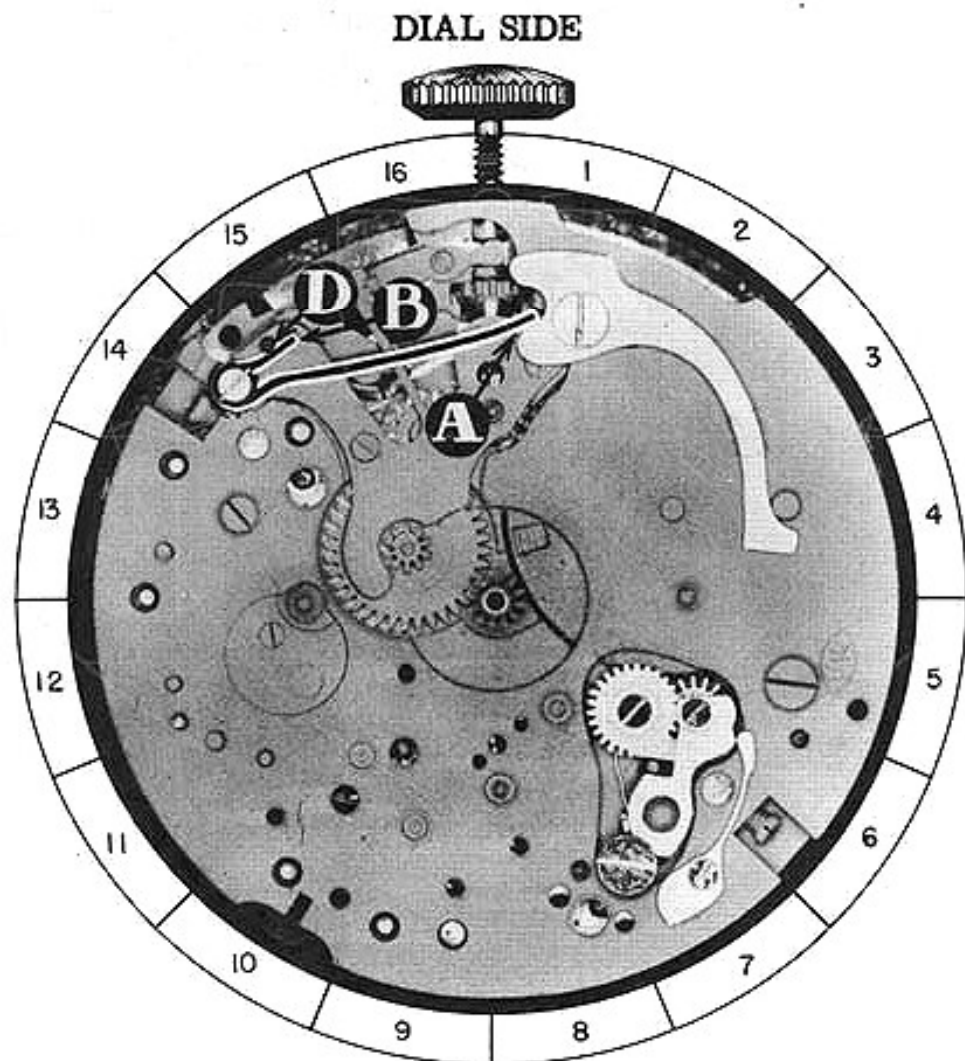

9-A

A. DISASSEMBLY PROCEDURE OF HOUR FLYBACK LEVER:

The hour flyback lever is held in place by shouldered screw SS-5. When this screw is removed, the hour flyback lever will be free on the plate and can be lifted out of place.

(The shape of screw for this part is shown at bottom of page.)

B. ASSEMBLY PROCEDURE OF HOUR FLYBACK LEVER:

Place the hour flyback lever in its proper position on the plate as shown in the photograph. Make sure that the hole in flyback lever is over proper hole in plate; also the pin "B" on the hour flyback lever must be down in hole in plate. Now replace shouldered screw SS-5 that holds this lever in place. After screw is replaced, check flyback lever to see that it pivots freely under the head of this screw.

REMARKS:

You will notice the pin "C" as shown in the photograph. This pin is to prevent the flyback lever from being forced too far away from the center of the watch. This limits the travel of the flyback lever.

C. FUNCTION OF HOUR FLYBACK LEVER:

The function of the hour flyback lever is to return the hour register wheel and the hand connected to the wheel to a zero position. When the flyback lever is forced in toward the center of the watch, end "A" of hour flyback lever contacts the heart on hour register wheel. This returns this wheel to a zero position.

REFERENCE: Hour register wheel is Assembly 8.

REMARKS:

The flat end "A" of flyback lever must be highly polished, as any roughness or pits of rust at this location may cause the hour flyback lever not to function properly. When polishing the end of this lever, care should be taken so as not to change the shape of it.

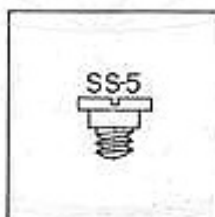

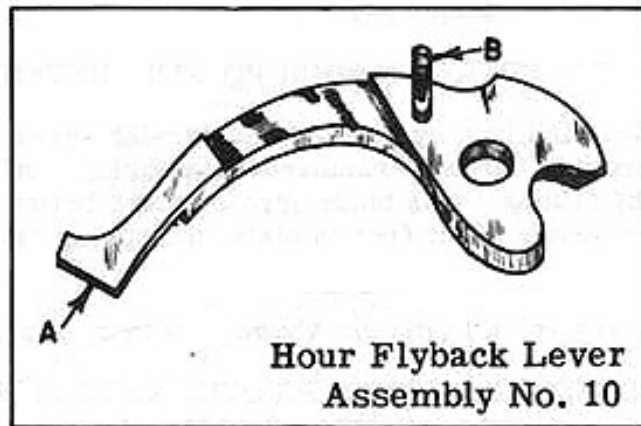

OILING

The shoulder of shouldered screw on which the hour flyback lever pivots should be slightly moistened with oil.

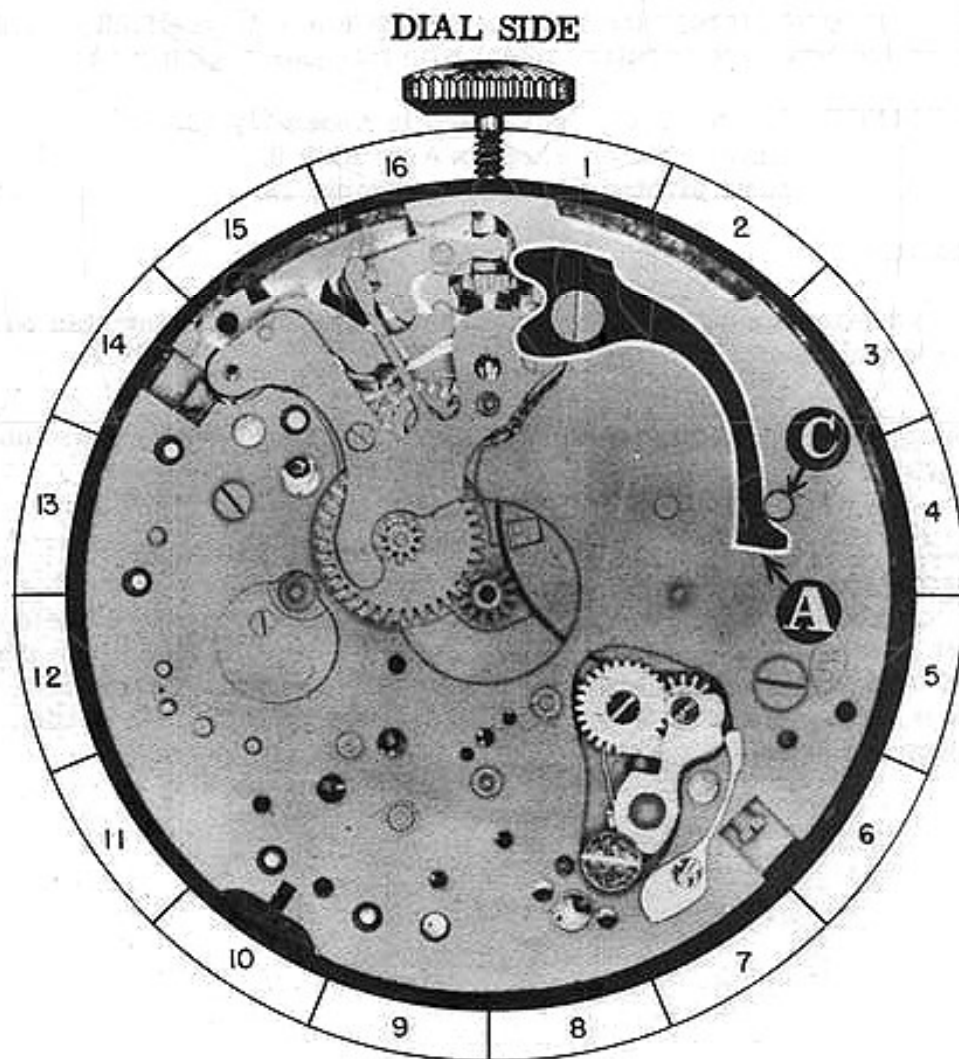

10-A

A. DISASSEMBLY PROCEDURE OF HOUR PIVOTED DETENT SPRING:

This spring is held in place by beveled countersink screw BS-2 and a steady pin. When this screw is removed, this spring can be loosened from the plate by sliding a thin blade screw-driver between the spring and plate. After steady pin is free in plate, the spring can be lifted out of place.

(The shape of screw for this part is shown at bottom of page.)

B. ASSEMBLY PROCEDURE OF HOUR PIVOTED DETENT SPRING:

Place the hour pivoted detent spring in its proper position on the plate as shown in the photograph. The steady pin "B" must be entering its proper hole in the plate. Now press spring down to proper place with back of tweezers and replace beveled countersink screw BS-2.

C. FUNCTION OF HOUR PIVOTED DETENT SPRING:

The function of this spring is to hold a tension on the hour pivoted detent. This spring forces the hour pivoted detent to turn slightly. This engages the hour intermediary wheel with the hour register wheel.

REFERENCE: Intermediary hour wheel is Assembly 12.
Hour register wheel is Assembly 8.
Hour pivoted detent is Assembly 13.

REMARKS:

When adjusting spring for proper tension, it is good to follow this policy as a general rule:

A spring should hold only enough tension on a part to perform its function properly.

Any excess tension on a part in the chronograph mechanism will cause the chronograph to be harder to work, also causing more wear, etc. Of course, the amount of pressure that the spring should hold on a part is determined in the factory. Because of this, it is seldom that you should have to adjust a spring. However, you may have to make one of these springs, and the above information should aid you in setting the proper tension.



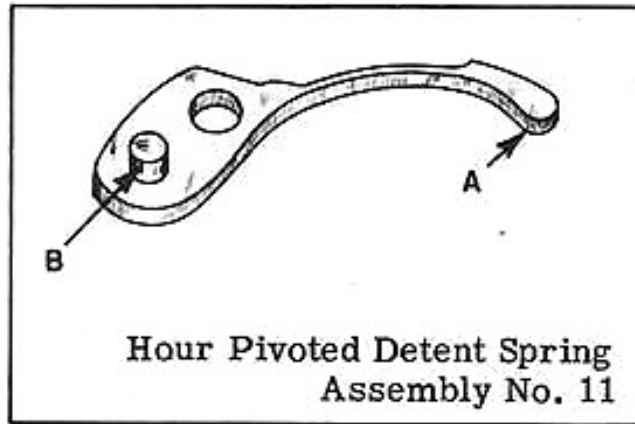

OILING

End "A" on hour pivoted detent spring should be slightly moistened with oil at point of contact with hour pivoted detent.

DIAL SIDE

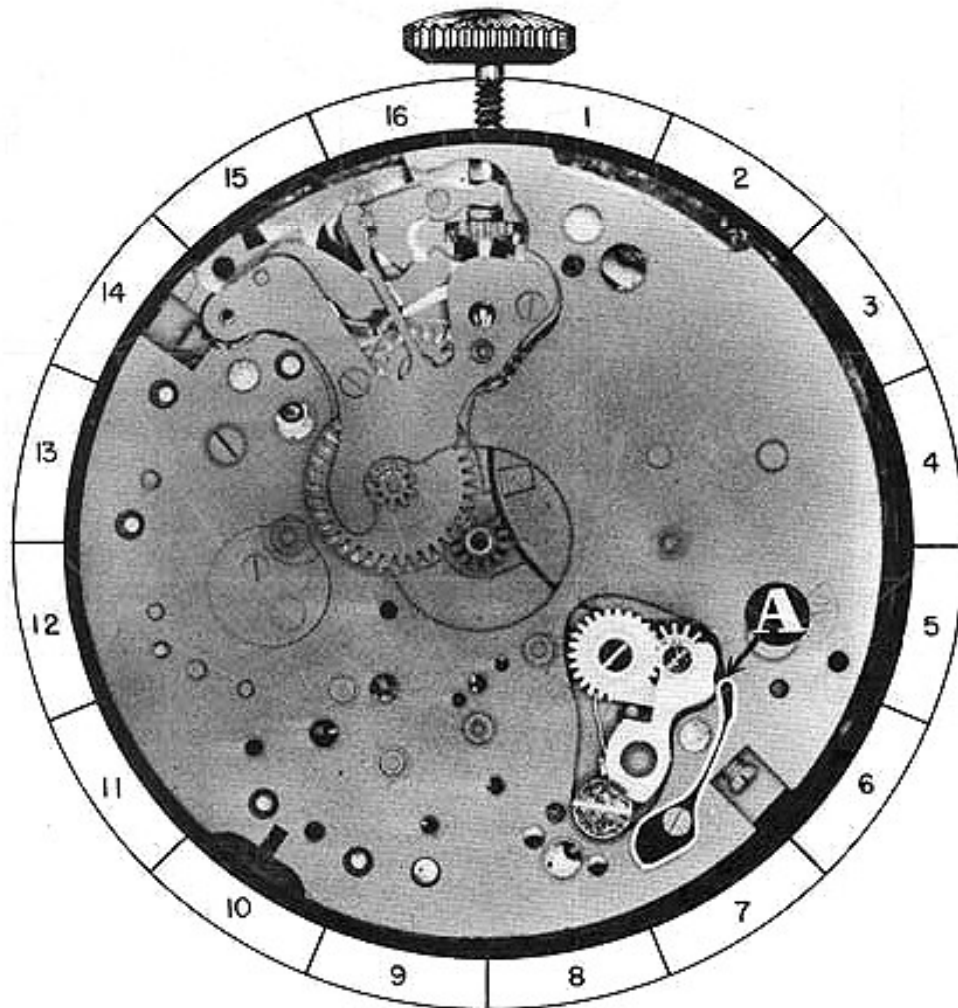

11-A

A. DISASSEMBLY PROCEDURE OF INTERMEDIARY HOUR WHEEL:

This wheel is held in place by shouldered screw SS-6. After this screw is removed, the intermediary hour wheel will be free on the hour pivoted detent and can be lifted out of place.

REFERENCE: Hour pivoted detent is Assembly 13.

(The shape of screw for this part is shown at bottom of page.)

B. ASSEMBLY PROCEDURE OF INTERMEDIARY HOUR WHEEL:

Place the intermediary hour wheel in its proper position on the hour pivoted detent with pinion "A" facing up. Before replacing shouldered screw, check to see that end "B" of spring on hour pivoted detent is engaged with the teeth on the intermediary hour wheel. Now replace shouldered screw SS-6 that holds intermediary wheel in its place. After this hour wheel is replaced, check this wheel to see that it is not binding under the head of shouldered screw.

REFERENCE: Hour pivoted detent is Assembly 13.

C. FUNCTION OF INTERMEDIARY HOUR WHEEL:

The function of the intermediary hour wheel is to transfer the power from the transmission pinion to the hour register wheel when these wheels are engaged. This wheel continues to turn as long as the watch is running.

REFERENCE: Transmission pinion is Assembly 14.
Hour register wheel is Assembly 8.

REMARKS:

If the head of a shouldered screw tightens down on a part preventing it from functioning properly, the shoulder of the screw is shorter than the thickness of the lever. To correct this, the head of the shouldered screw must be cut back to lengthen the shoulder on the screw.

I do not want to give the impression that lengthening the shoulder on a shouldered screw will always free a part under it; many times it is the diameter of the shoulder that is causing the lever to be tight. Naturally, to correct this the diameter of the shoulder must be cut down slightly for freedom.

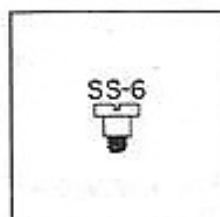

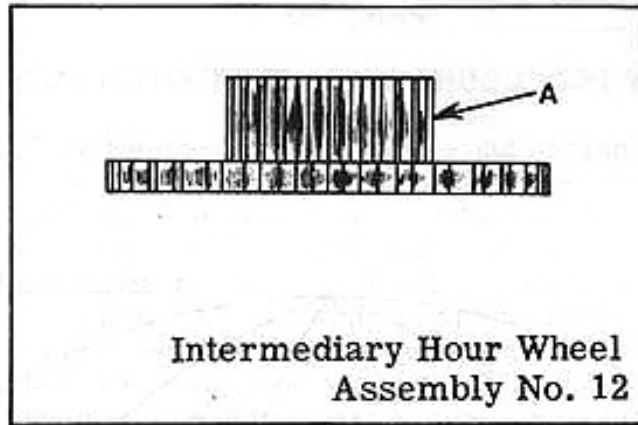

OILING

The shoulder of screw on which the intermediary hour wheel pivots should be slightly moistened with oil.

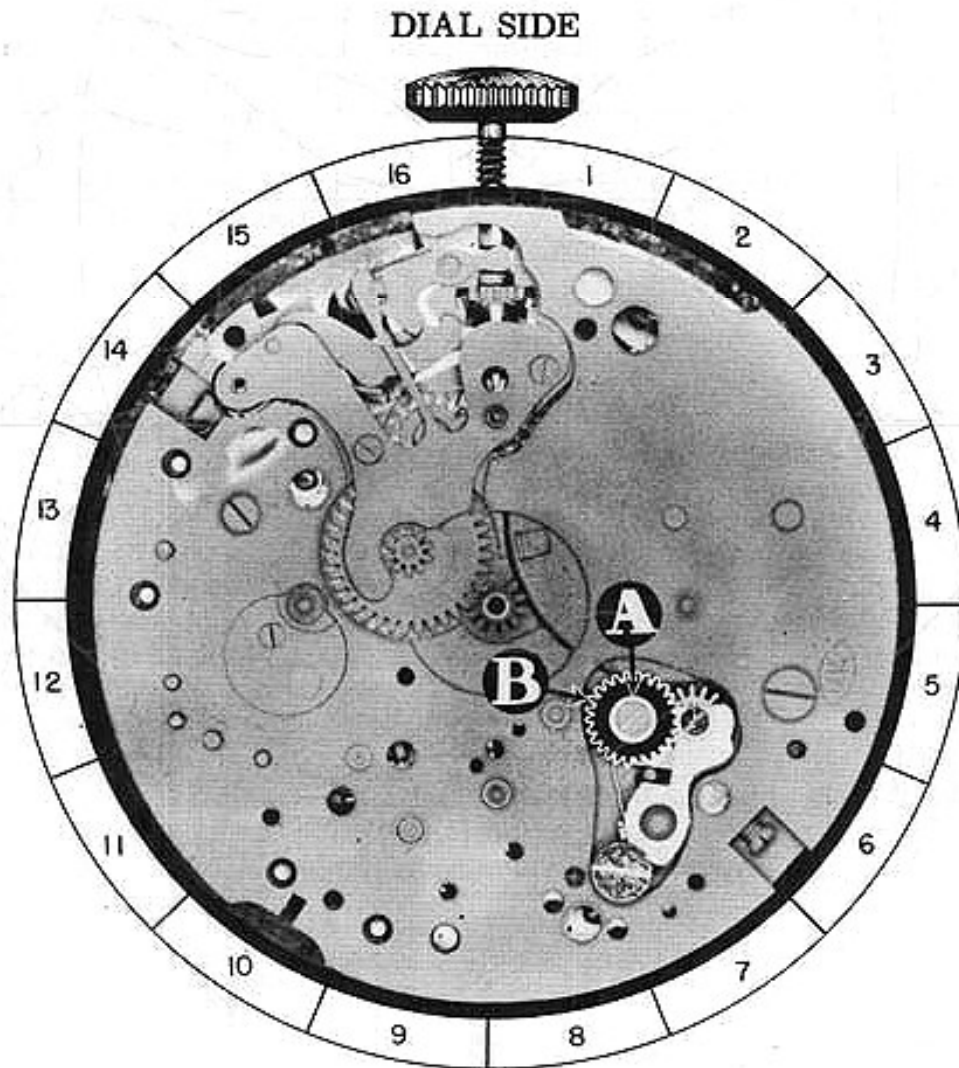

12-A

A. DISASSEMBLY PROCEDURE OF HOUR PIVOTED DETENT:

This detent is held in place by shouldered screws SS-7, SS-8, and BS-3. The positions of these screws are shown in the photograph. After screws SS-7 and SS-8 are removed, the hour pivoted detent will be free on the plate and can be lifted out of place. After the hour pivoted detent is removed, the tension spring on hour pivoted detent can be removed. This tension spring is shown as "A" in the isometric drawing. To remove this tension spring, remove beveled countersink screw BS-3 that holds this tension spring to the hour pivoted detent. After this screw is removed, this spring will be free and can be removed from hour pivoted detent.

(The shape of screws for this part is shown at bottom of page.)

B. ASSEMBLY PROCEDURE OF HOUR PIVOTED DETENT:

Place the tension spring "A" as shown in the isometric drawing on the hour pivoted detent in the position as shown in the drawing. Now replace beveled countersink screw BS-3 that holds this tension spring to the hour pivoted detent. After this spring is replaced, you can replace the hour pivoted detent in its proper position in the watch as shown in the photograph. Now replace shouldered screws SS-7 and SS-8. The positions of these screws are shown in the photograph. After these screws are replaced, check the transmission pinion to see that it is not binding under the head of shouldered screw SS-7. Also check to see that the hour pivoted detent pivots freely under the head of shouldered screw SS-8.

REFERENCE: Transmission pinion is Assembly 14.

C. FUNCTION OF HOUR PIVOTED DETENT:

The function of the hour pivoted detent is to engage and disengage the intermediary hour wheel with the hour register wheel.

The function of spring "A" is to hold a tension on intermediate hour wheel, thus eliminating any lost motion between this wheel and the transmission pinion or any lost motion in the teeth between the transmission pinion and the barrel. This allows for a smooth steady flow of power to the intermediate hour wheel. This spring makes it possible that when the intermediate hour wheel is engaged with the hour wheel, there is no lost motion between the teeth of these wheels to cause an inaccurate registering of the hour.

REFERENCE: Intermediary hour wheel is Assembly 12.

Hour register wheel is Assembly 8.

Transmission pinion is Assembly 14.

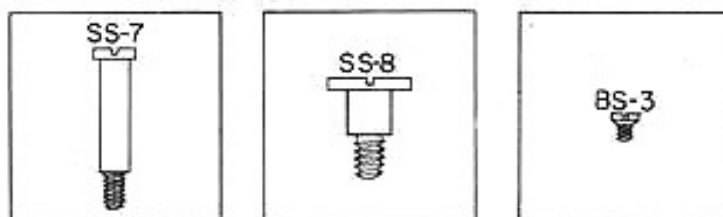

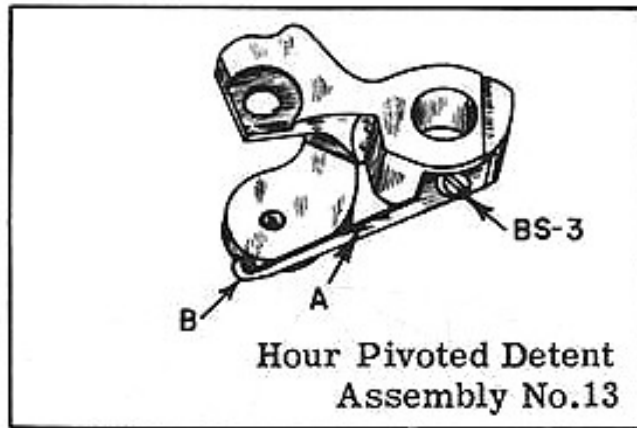

OILING

The shoulder of the long shouldered screw SS-7 on which the hour pivoted detent pivots should be slightly moistened with oil.

DIAL SIDE

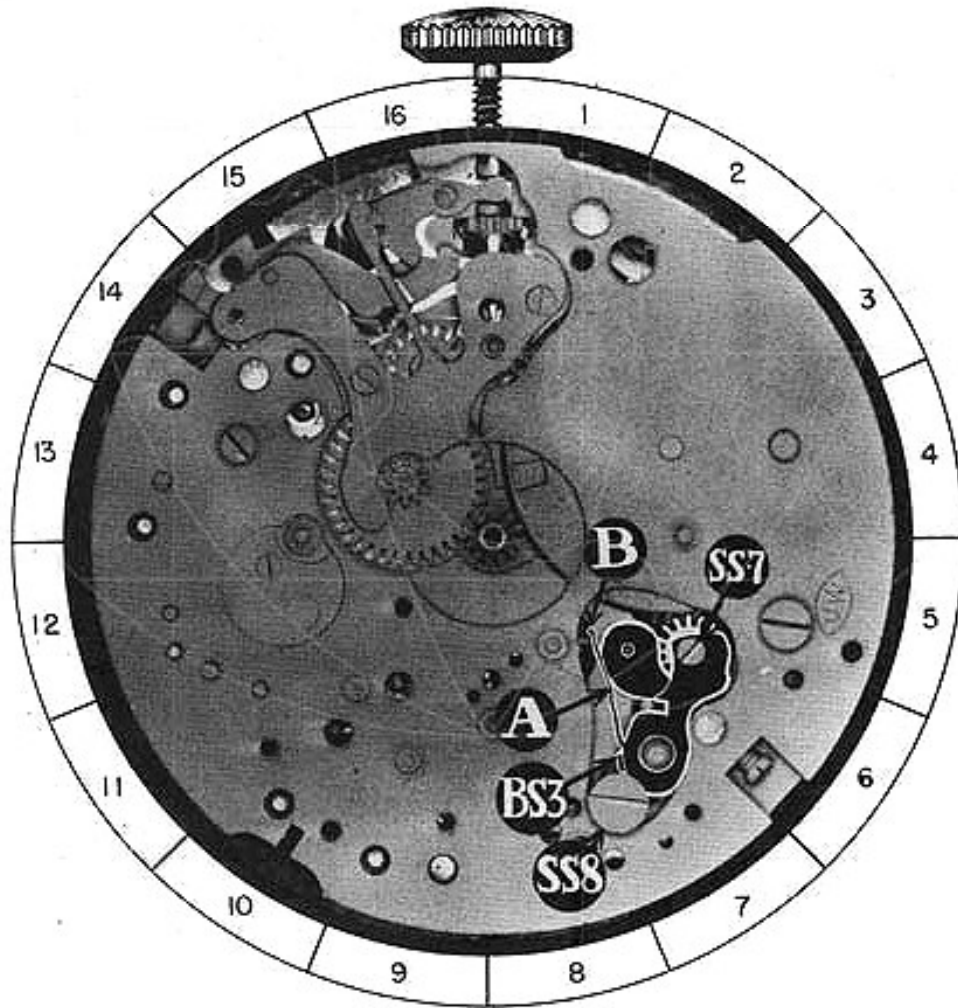

13-A

A. DISASSEMBLY PROCEDURE OF TRANSMISSION PINION:

To remove this pinion, grip pinion with a pair of tweezers and lift straight up on pinion lifting it out of place.

Important: The removal of this part completes disassembly of the dial side of this mechanism. Now turn movement over with train side facing you and continue to disassembly mechanism by following the instructions in this book.

B. ASSEMBLY PROCEDURE OF TRANSMISSION PINION:

Place pinion in its proper position down in recess in plate with small pinion "A" up. The large end "B" of this pinion must be placed down in the recess in the plate. The next part to be replaced holds this pinion in place.

C. FUNCTION OF TRANSMISSION PINION:

The function of this pinion is to transmit the power from the main spring barrel to the intermediary hour wheel. This pinion continues to turn as long as the watch is running.

REFERENCE: Intermediary hour wheel is Assembly 12.

REMARKS:

When disassembling the chronograph, each part should be carefully examined as it is removed from the movement. Each part should be checked against the isometric drawings to see that the part is the correct shape and is not broken. Each part should also be checked for any pits of rust, roughness, or burrs, and for worn parts which may cause the part not to work properly.

The replacement of a defective part in the chronograph may necessitate complete disassembly of the chronograph. Through a close examination of each part, you will soon become familiar with the parts of the chronograph. This will enable you to quickly recognize a defective part and repair it before replacing it in the chronograph.

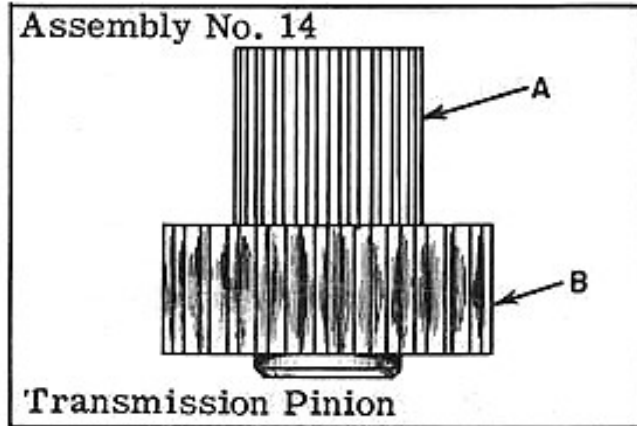

OILING

The shoulder of shouldered screw SS-7 on which the transmission pinion pivots should be slightly moistened with oil.

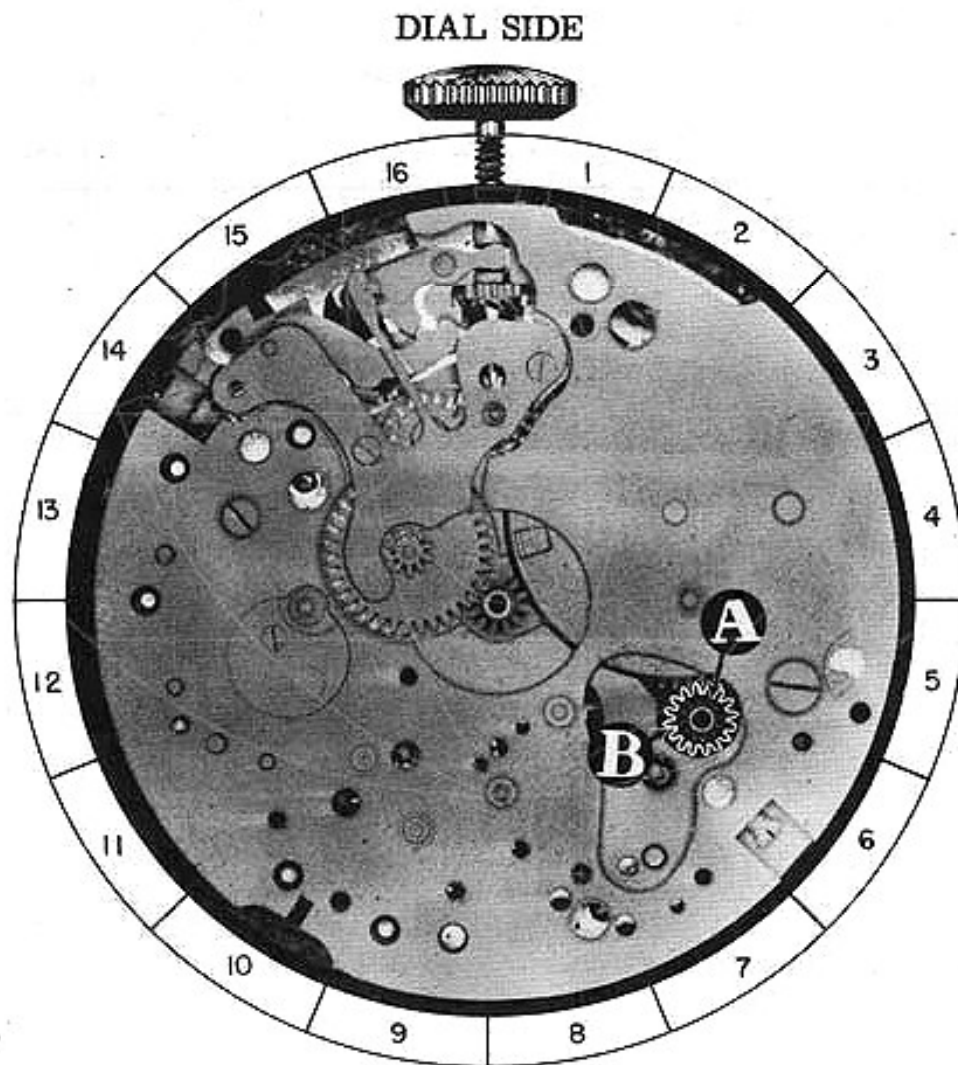

14-A

A. DISASSEMBLY PROCEDURE OF WHEEL OVER FOURTH WHEEL:

The wheel over fourth wheel fits friction tight on the long pivot on fourth wheel pinion. This wheel should be removed with a sweep wheel remover but can be removed with two small thin edge screw-drivers. The screw-drivers are placed opposite each other under hub of wheel. One screw-driver is turned clock-wise, while the other screw-driver is turned counter-clockwise.

B. HAZARDS IN DISASSEMBLY OF WHEEL OVER FOURTH WHEEL:

The wheel over fourth wheel fits over very thin long pivot of fourth wheel pinion which, as you know, is very delicate and easily bent or broken. The main reason why we select this part to be removed first is to lessen hazard of bending the long pivot on the fourth wheel pinion when removing the other parts of the chronograph mechanism. If the sweep wheel remover is held perfectly upright in removing wheel, hazard in bending fourth wheel pivot will be eliminated.

C. ASSEMBLY PROCEDURE OF WHEEL OVER FOURTH WHEEL:

This wheel fits over fourth wheel long pivot and should be placed on pivot with hub "A" of wheel down. Wheel over fourth wheel should be pushed down until it is level with the intermediary wheel. A hollow, flat-faced punch should be used to push wheel down.

REFERENCE: Intermediary wheel is Assembly 19.

D. HAZARDS IN ASSEMBLY OF WHEEL OVER FOURTH WHEEL:

Use care in staking down this wheel so that you will not bend or break the fourth wheel pivot. If movement is held level, the hazard of replacing this wheel will be eliminated.

E. FUNCTION OF WHEEL OVER FOURTH WHEEL:

The function of this wheel is to transmit the power from the train of the watch to the chronograph mechanism. This wheel continues to turn as long as the watch is running.

Important: The replacing of this part completes the assembly of the train side of the chronograph mechanism. Now turn movement over with dial side facing you and continue to assembly mechanism by following the instructions in this book.

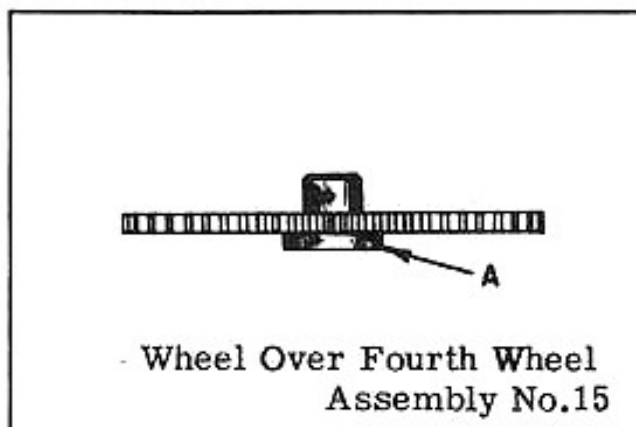

OILING

The wheel over fourth wheel should not be oiled.

TRAIN SIDE



15-A

A. DISASSEMBLY PROCEDURE OF MINUTE REGISTER PAWL:

The minute register pawl is held in place by steady pins and fillister head screw FS-3. Remove screw and loosen pawl from plate by sliding a thin blade screw-driver between pawl and plate. When steady pins are free in plate, pawl may be lifted out of place.

(The shape of screw for this part is shown at bottom of page.)

B. ASSEMBLY PROCEDURE OF MINUTE REGISTER PAWL:

Place pawl on plate with steady pins in pawl over proper holes in plate. Press pawl down to proper place with back of tweezers and replace fillister head screw FS-3. The end "A" of pawl should lie directly in center of two teeth on minute register wheel.

C. HAZARDS IN ASSEMBLY OF MINUTE REGISTER PAWL:

Before pressing the pawl down in proper place on plate, be sure that end "A" of pawl is not on top of a tooth on the minute register wheel.

REFERENCE: Minute register wheel is Assembly 30.

D. FUNCTION OF MINUTE REGISTER PAWL:

1. This pawl correctly spaces the turning of the minute register wheel. This eliminates the possibility of the minute register wheel setting at an incorrect position.
2. It holds the minute register wheel in a stationary position so a bump will not alter the position of this wheel.

REMARKS:

After replacing pawl, push flyback lever toward center of watch until it returns minute register wheel to a zero position. With the minute register wheel in this position, the end "A" of pawl should lie directly in center of two teeth on the minute register wheel.

The tension end "A" of pawl holds on minute register wheel must be very light as any excess tension will cause the minute register wheel to be unnecessarily hard to turn; yet the tension must be strong enough for the pawl to function properly as stated above. The end "A" of pawl must be highly polished, as any roughness here will hinder the proper operation of the chronograph.

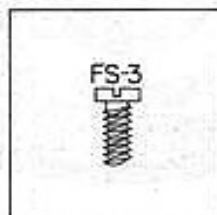

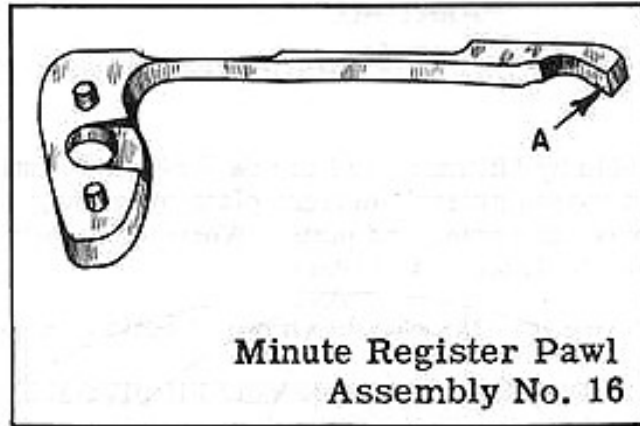

OILING

The minute register pawl should not be oiled.

TRAIN SIDE

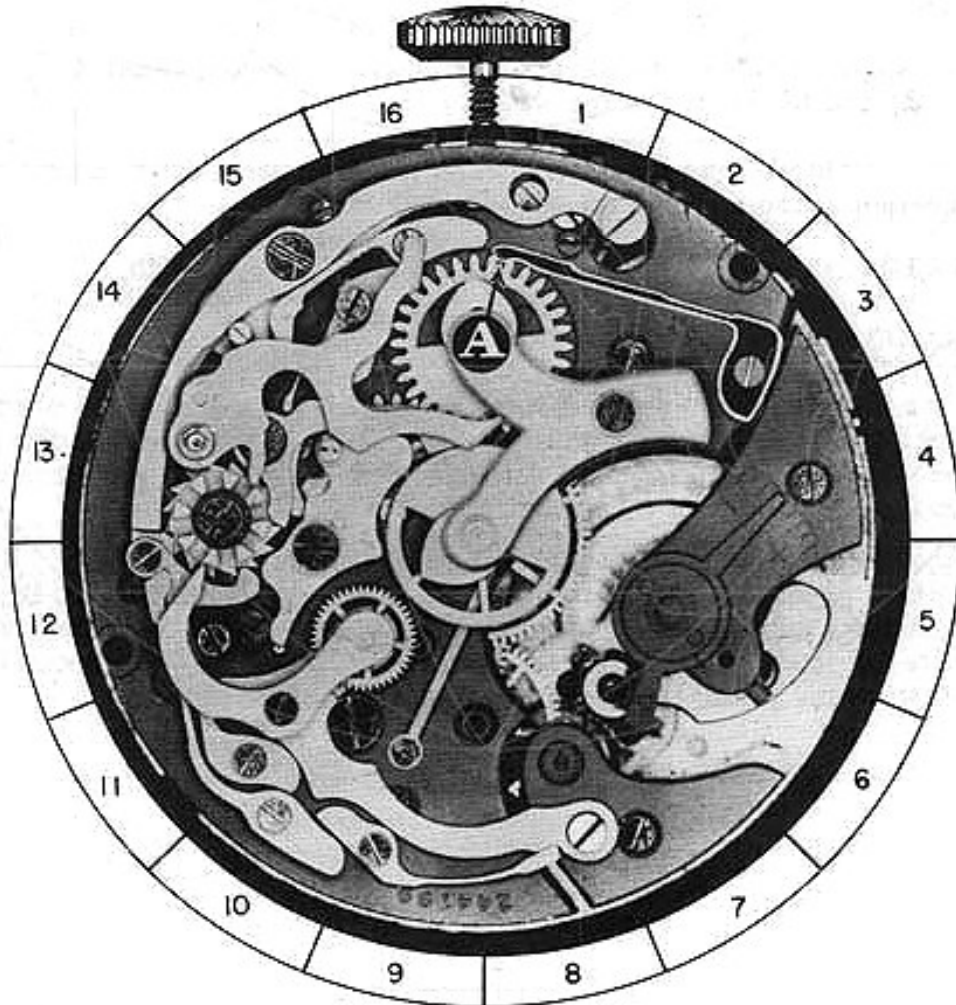

A. DISASSEMBLY PROCEDURE OF CHRONOGRAPH PIVOTED DETENT SPRING:

This spring is held by fillister head screw FS-4 and a steady pin. Remove screw and loosen steady pin from plate by sliding a thin blade screw-driver between spring and plate. When steady pin is free in plate, spring may be lifted out of place.

(The shape of screw for this part is shown at bottom of page.)

B. ASSEMBLY PROCEDURE OF CHRONOGRAPH PIVOTED DETENT SPRING:

Place spring on plate with steady pin in proper hole. Before pressing spring down to proper place, check to see that end "A" of spring is on top of chronograph pivoted detent. When spring is in proper place, press down and replace fillister screw FS-4.

C. FUNCTION OF CHRONOGRAPH PIVOTED DETENT SPRING:

The function of the chronograph pivoted detent spring is to do two things:

1. This spring holds a tension on chronograph pivoted detent forcing it toward the center of the watch.
2. This spring helps hold chronograph pivoted detent down in place keeping it from riding up.

REFERENCE: Chronograph pivoted detent is Assembly 20.

REMARKS:

The tension the chronograph pivoted detent spring holds on the chronograph pivoted detent must be strong enough to engage intermediary wheel with the seconds wheel. Any excess tension tends to make the chronograph harder to work manually.

Endshake of intermediary wheel should be checked at this place. Also this wheel should be checked to see that it spins freely. In checking the endshake on this wheel, check to see that the endshake is not excessive. If it is, the intermediary wheel can drop below the seconds wheel when the watch is placed in a dial-up position.

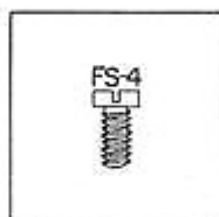

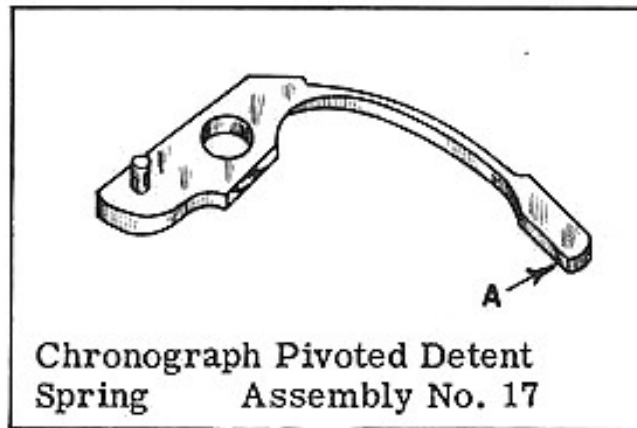

OILING

End "A" of chronograph pivoted detent spring should be slightly moistened with oil at point of contact with chronograph pivoted detent.



A. DISASSEMBLY PROCEDURE OF CHRONOGRAPH PIVOTED DETENT BRIDGE:

This bridge is held in place by fillister head screw FS-5 and steady pins. Remove screw and loosen bridge from detent with a thin blade screw-driver. When steady pins are free in detent, bridge may be lifted from detent.

(The shape of screw for this part is shown at bottom of page.)

B. HAZARDS IN DISASSEMBLY OF CHRONOGRAPH PIVOTED DETENT BRIDGE:

When using the screw-driver in loosening bridge from detent, care should be taken to keep bridge level, as any twisting may damage pivots on intermediary wheel or burr the bushings in bridge or pivoted detent. The screw-driver should be carefully used so as not to mar the chronograph pivoted detent or bridge.

C. ASSEMBLY PROCEDURE OF CHRONOGRAPH PIVOTED DETENT BRIDGE:

Place bridge on pivoted detent with steady pins over proper holes in detent. Place intermediary wheel so pivot on this wheel will enter bushing in bridge. The bridge may now be pressed down to proper position with back of tweezers and fillister head screw FS-5 replaced.

D. HAZARDS IN ASSEMBLY OF CHRONOGRAPH PIVOTED DETENT BRIDGE:

Keep bridge level when pressing down to position, as any twisting may damage the pivots on intermediary wheel. Check to see that there are no burrs on the surface of either the pivoted detent or the bridge at the point these parts fit together. Any burrs at this location may cause intermediary wheel to have excess endshake or to bind.

REFERENCE: Chronograph pivoted detent is Assembly 20.

E. FUNCTION OF CHRONOGRAPH PIVOTED DETENT BRIDGE:

1. The function of this bridge is to hold the intermediary wheel in place so that it can function properly.
2. The beak "A" of bridge contacts the castle wheel making it possible for the chronograph pivoted detent to function properly.

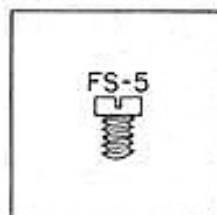

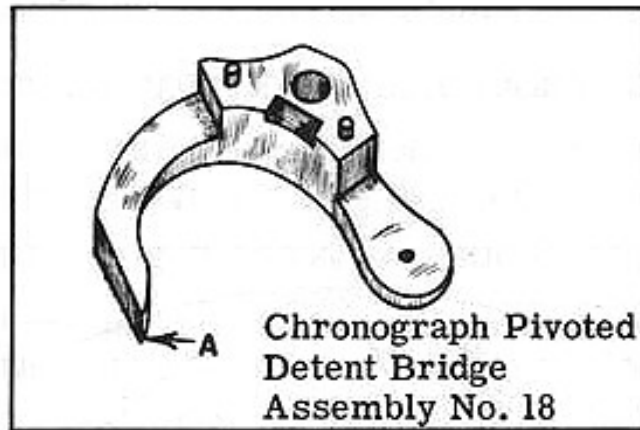

OILING

The pivot in pivot hole in chronograph pivoted detent bridge should be oiled as you usually oil a train pivot in a watch.

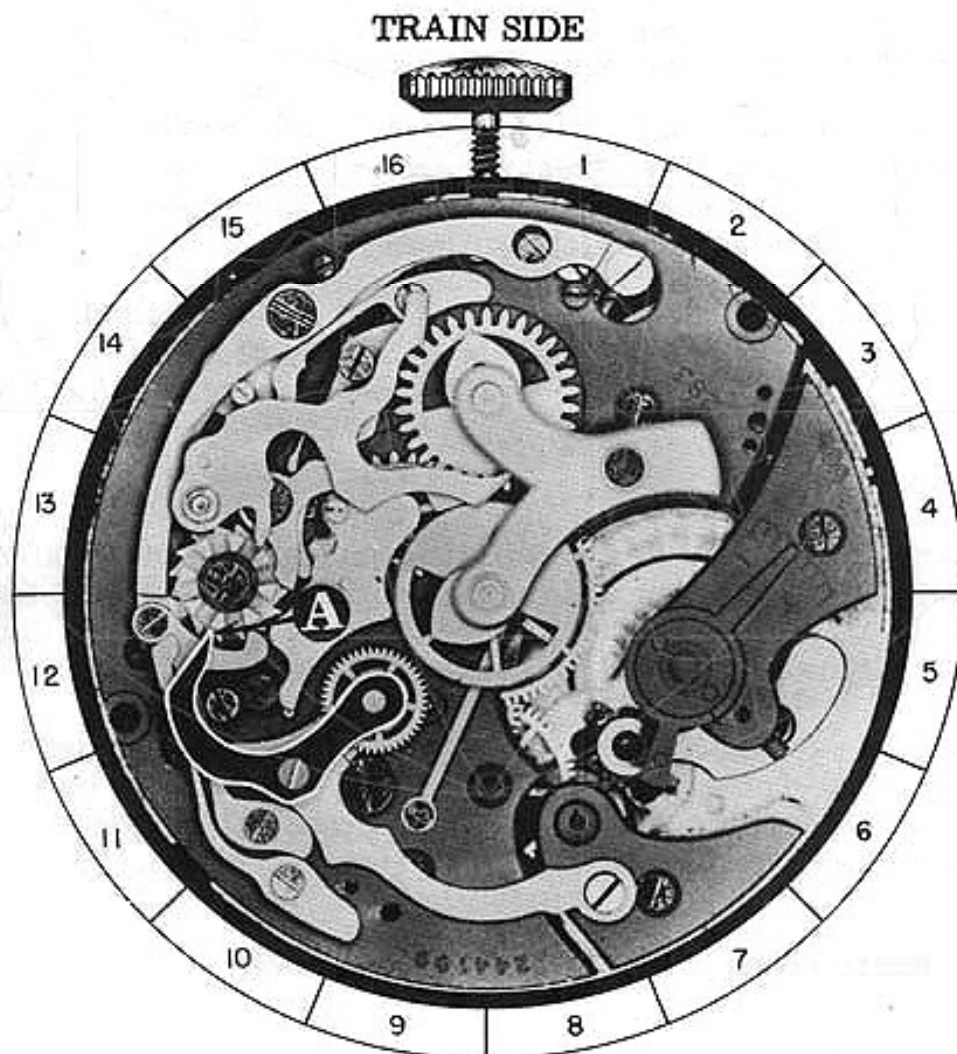

18-A

A. DISASSEMBLY PROCEDURE OF INTERMEDIARY WHEEL:

When removing the intermediary wheel, lift the wheel straight up to remove the pivot from chronograph pivoted detent.

B. ASSEMBLY PROCEDURE OF INTERMEDIARY WHEEL:

When replacing intermediary wheel, the long end "A" of staff should be up. Place the bottom pivot of staff in hole in bushing of chronograph pivoted detent.

C. HAZARDS IN ASSEMBLY OF INTERMEDIARY WHEEL:

The pivoted hole in bushing of chronograph pivoted detent should be carefully examined before replacing the intermediary wheel. Any imperfection here will affect the timekeeping of the watch and hinder the proper operation of the chronograph.

D. FUNCTION OF INTERMEDIARY WHEEL:

The function of the intermediary wheel is to transmit the power from the wheel over fourth wheel to seconds wheel when these wheels are engaged. The intermediary wheel continues to turn as long as the watch is running.

REFERENCE: Chronograph pivoted detent is Assembly 20.
Seconds wheel is Assembly 31.
Wheel over fourth wheel is Assembly 15.

REMARKS:

A carefully and detailed examination should be made of all wheels before replacing in the chronograph. Each wheel should be examined for burred pivots, bent or burred teeth, dirt or small pieces of grit wedged between the teeth.

When the saw teeth of one wheel meshes into the saw teeth of another wheel, there is very little clearance between the teeth and because of this, even the smallest piece of grit or dirt wedged into one of these teeth may stop the chronograph.

The intermediary wheel is a saw tooth wheel.

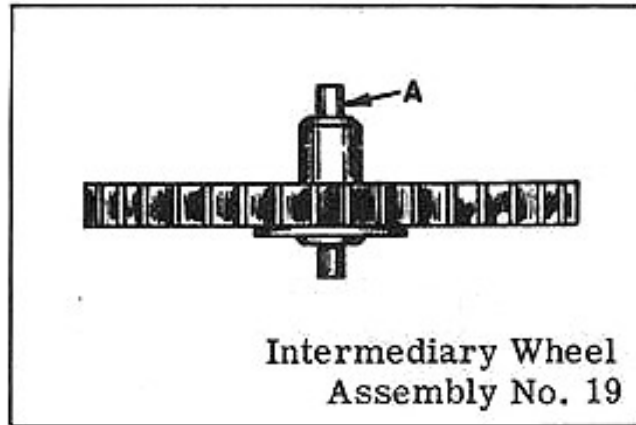

OILING

The bottom pivot on intermediary wheel should be oiled before placing this wheel in chronograph pivoted detent. The top pivot should be oiled after bridge for this wheel is replaced.

TRAIN SIDE

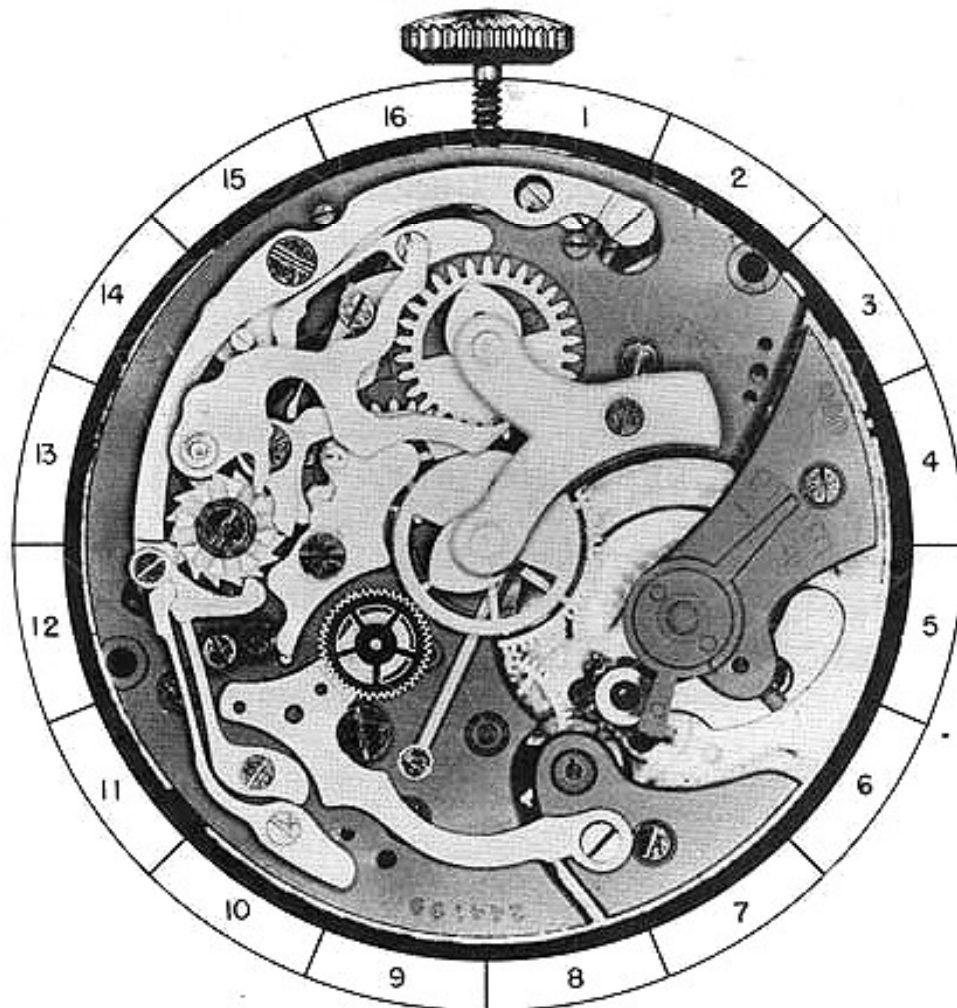

19-A

A. DISASSEMBLY PROCEDURE OF CHRONOGRAPH PIVOTED DETENT:

This detent is held in place by shouldered screw SS-9 and pivots on an eccentric stud. After shouldered screw is removed, the detent may be lifted from eccentric stud and lifted straight up freeing the post "A" on chronograph pivoted detent from hole in place.

(The shape of screw for this part is shown at bottom of page)

B. ASSEMBLY PROCEDURE OF CHRONOGRAPH PIVOTED DETENT:

Place detent on plate with post "A" on detent down in proper hole in plate. Also place hole "B" in detent over eccentric stud as this detent pivots on this stud. After chronograph pivoted detent is in proper position, replace shouldered screw SS-9. The detent should be checked to see that it moves freely under the head of this screw.

C. HAZARDS IN ASSEMBLY OF CHRONOGRAPH PIVOTED DETENT:

After replacing detent, check to see that it has enough freedom to move freely under the head of screw and yet does not have excess freedom.

D. FUNCTION OF CHRONOGRAPH PIVOTED DETENT:

The function of the chronograph pivoted detent is to engage and disengage intermediary wheel with the seconds wheel.

REFERENCE: Intermediary wheel is Assembly 19.
Seconds wheel is Assembly 31.

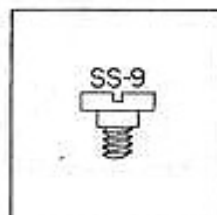

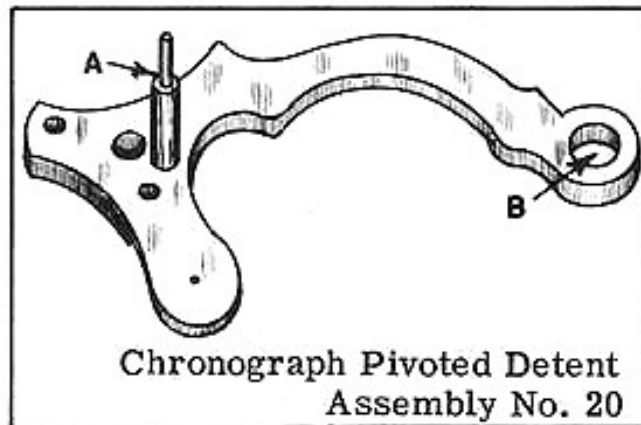

OILING

The eccentric stud on which the chronograph pivoted detent pivots should be slightly moistened with oil.

TRAIN SIDE

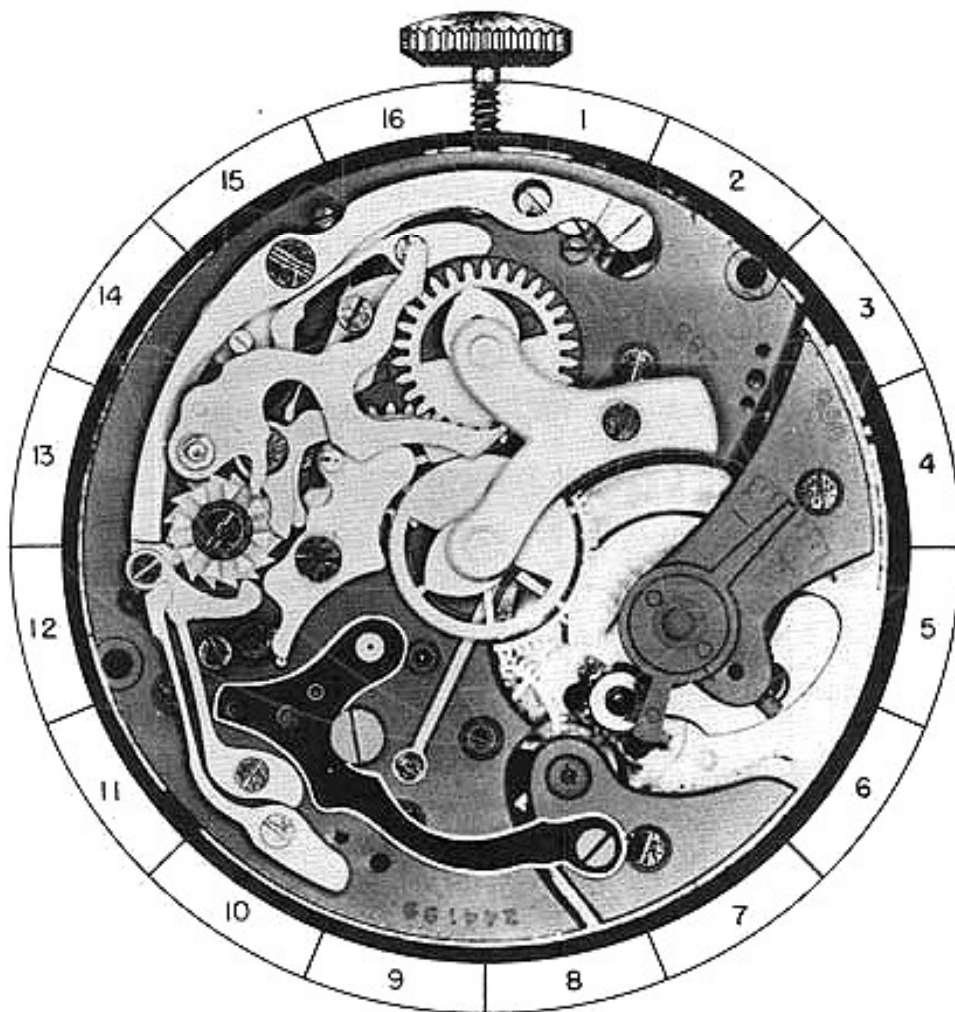

20-A

A. DISASSEMBLY PROCEDURE OF ACTUATING DETENT LEVER SPRING:

This spring is held in place by fillister screw FS-6 and a steady pin. After this screw is removed, spring may be loosened from plate by sliding a thin blade screw-driver between spring and plate. When steady pin is free in plate, spring may be lifted out of place.

(The shape of screw for this part is shown at bottom of page.)

B. ASSEMBLY PROCEDURE OF ACTUATING DETENT LEVER SPRING:

Place spring on plate with steady pin over proper hole in plate. Place end "A" of spring on top of the joint hook. When spring is in proper position, press spring down to proper place and replace fillister head screw FS-6.

REFERENCE: Joint hook is Assembly 22.

C. FUNCTION OF ACTUATING DETENT LEVER SPRING:

The function of this spring is to do three things:

1. It keeps the joint hook engaged with the ratchet teeth on the castle wheel.
2. It holds a tension on joint hook forcing it toward the center of the watch.
3. It helps hold joint hook down in place.

REMARKS:

The end "B" of actuating detent is sometimes hard to depress causing the chronograph to be harder to work by the operator. A combination of one or more of the following reasons can cause this:

1. The actuating detent lever spring holding too strong a tension on actuating detent.
2. The castle wheel pawl holding too strong a tension on castle wheel.
3. Improper oiling of the castle wheel.

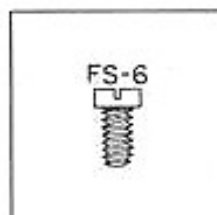

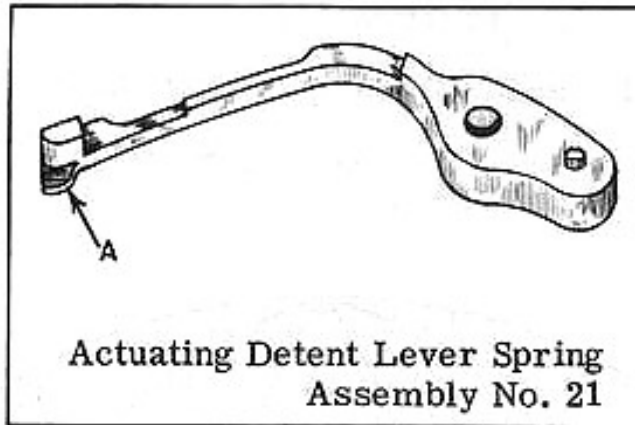

OILING

End "A" of actuating detent lever spring should be slightly moistened with oil at point of contact with joint hook.

TRAIN SIDE



21-A

A. DISASSEMBLY PROCEDURE OF JOINT HOOK:

The joint hook is held in place by shouldered screw SS-10. Remove screw and joint hook may be lifted from actuating detent lever.

REFERENCE: Actuating detent lever is Assembly 23.

(The shape of screw for this part is shown at bottom of page.)

B. ASSEMBLY PROCEDURE OF JOINT HOOK:

Place the joint hook on end "A" of actuating detent lever. The hole in joint hook should be placed over hole in actuating detent lever. Also end "A" of joint hook should be in contact with the ratchet teeth on the castle wheel. Now replace shouldered screw SS-10 that holds the joint hook to the actuating detent lever. After the joint hook is replaced, joint hook should be checked to see that it moves freely under the head of shouldered screw SS-10.

C. FUNCTION OF JOINT HOOK:

The function of the joint hook is to move the castle wheel one tooth each time end "B" of actuating detent lever is pushed manually.

REFERENCE: Actuating detent lever is Assembly 23.
Castle wheel is Assembly 36.

The joint hook should be carefully examined for any burrs or roughness. This may cause it not to function properly. The end "A" of joint hook should be highly polished, as any burrs or roughness may cause the joint hook not to engage properly with the ratchet teeth on the castle wheel. When polishing this part, care should be taken that the shape of hook is not changed.

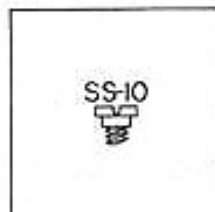

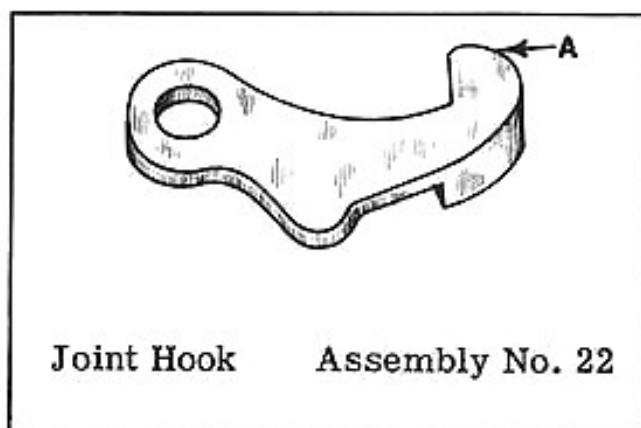

OILING

The shoulder of screw on which the joint hook pivots should be slightly moistened with oil.



22-A

A. DISASSEMBLY PROCEDURE OF ACTUATING DETENT LEVER:

This detent lever is held in place by shouldered screw SS-11 and pivots on this screw. When this screw is removed, the detent lever may be lifted from movement.

(The shape of screw for this part is shown at bottom of page.)

B. ASSEMBLY PROCEDURE OF ACTUATING DETENT LEVER:

Place actuating detent lever in its proper position on the plate as shown in the photograph. When the actuating detent lever is in its proper position, replace shouldered screw SS-11 that holds the detent lever in place. After screw is replaced, actuating detent lever should be checked to see that it pivots freely under the head of this screw.

C. FUNCTION OF ACTUATING DETENT LEVER:

The function of the actuating detent lever is to move the joint hook away from the center of the watch. This turns the castle wheel one tooth each time end "B" of actuating detent lever is pushed.

REFERENCE: Joint hook is Assembly 22.
Castle wheel is Assembly 36.

REMARKS:

The actuating detent lever works somewhat like a see-saw. When end "B" of actuating detent lever is pushed toward the center of the watch, end "A" is forced away from the center of the watch. Because the joint hook is attached to end "A" of the actuating detent lever, it is also forced away from the center of the watch, and at the same time causing castle wheel to move one tooth. When you have the actuating detent lever and joint hook replaced in the watch, you will notice the movement of this lever is limited by screw "D". This screw prevents the end "B" of actuating detent lever from being moved too far in toward the center of the watch, moving it more than is necessary to move the castle wheel one tooth. The position of this screw is shown in the photograph.



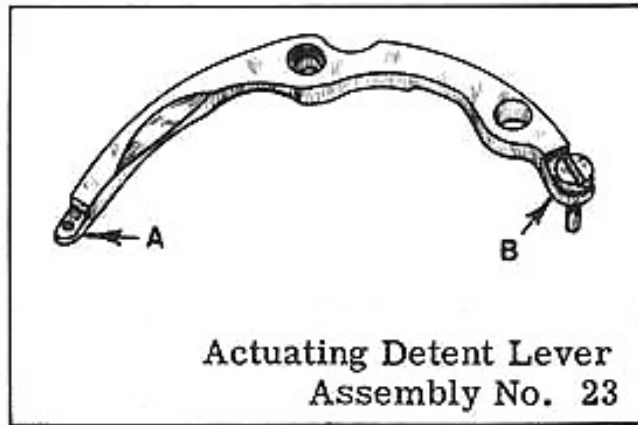

OILING

The shoulder of screw on which actuating detent lever pivots should be slightly moistened with oil.

TRAIN SIDE



23-A

A. DISASSEMBLY PROCEDURE OF FLYBACK LEVER:

Place a thin blade screw-driver at end "A" of flyback lever spring. Now force spring slightly toward the center of the watch while pressing down on spring. This will unhook the spring from the screw-head "C" on flyback lever. Now the flyback lever may be lifted from stud on plate and removed. To remove the flyback lever, the flyback lever should be in the position shown in the photograph.

REFERENCE: Flyback lever spring is Assembly 25.

B. HAZARDS IN DISASSEMBLY OF FLYBACK LEVER:

Before removing flyback lever, unhook flyback lever spring from screw "C" on under side of flyback lever. This must be done or in removing flyback lever you will bend or break flyback lever spring.

C. ASSEMBLY PROCEDURE OF FLYBACK LEVER:

Place flyback lever in position with screw-head "C" on flyback lever down. Press lever down until screw "C" rests on top of end "A" of flyback lever spring. Hold flyback lever down with finger. Now take a thin blade screw-driver and push end "A" of spring in toward the center of the watch. At the same time, raise it up slightly so that end "A" of spring can hook on inside of screw "C" on flyback lever.

D. FUNCTION OF FLYBACK LEVER:

The function of the flyback lever is to do three things:

1. It disengages brake lever from the seconds wheel.
2. It disengages intermittent wheel from seconds wheel dart tooth.
3. The ends "A" and "B" of flyback lever contact the hearts on seconds wheel and minute register wheel forcing these wheels and hands attached to them back to a zero position.

REFERENCE: Flyback lever spring is Assembly 25.
Brake lever is Assembly 27.
Seconds wheel is Assembly 31.
Minute register wheel is Assembly 30.
Intermittent lever and wheel assembly is
Assembly 34.

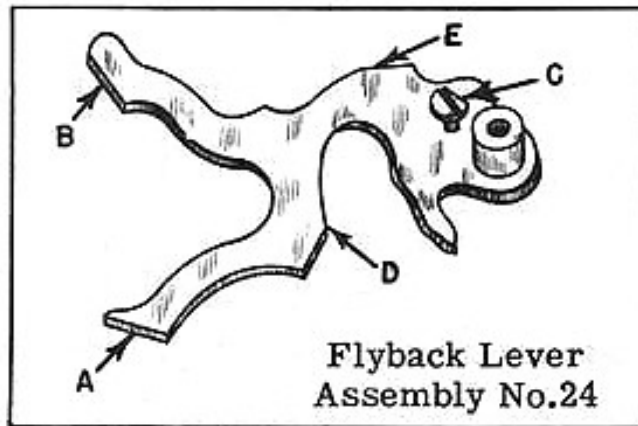

Slightly moisten the flyback lever with oil at these points:

1. The post on which the flyback lever pivots.
2. Screw "C" that contacts end "A" of flyback lever spring.
3. Surface "D" at point of contact with intermittent lever.
4. Surface "E" that contacts push piece for setting back to zero.

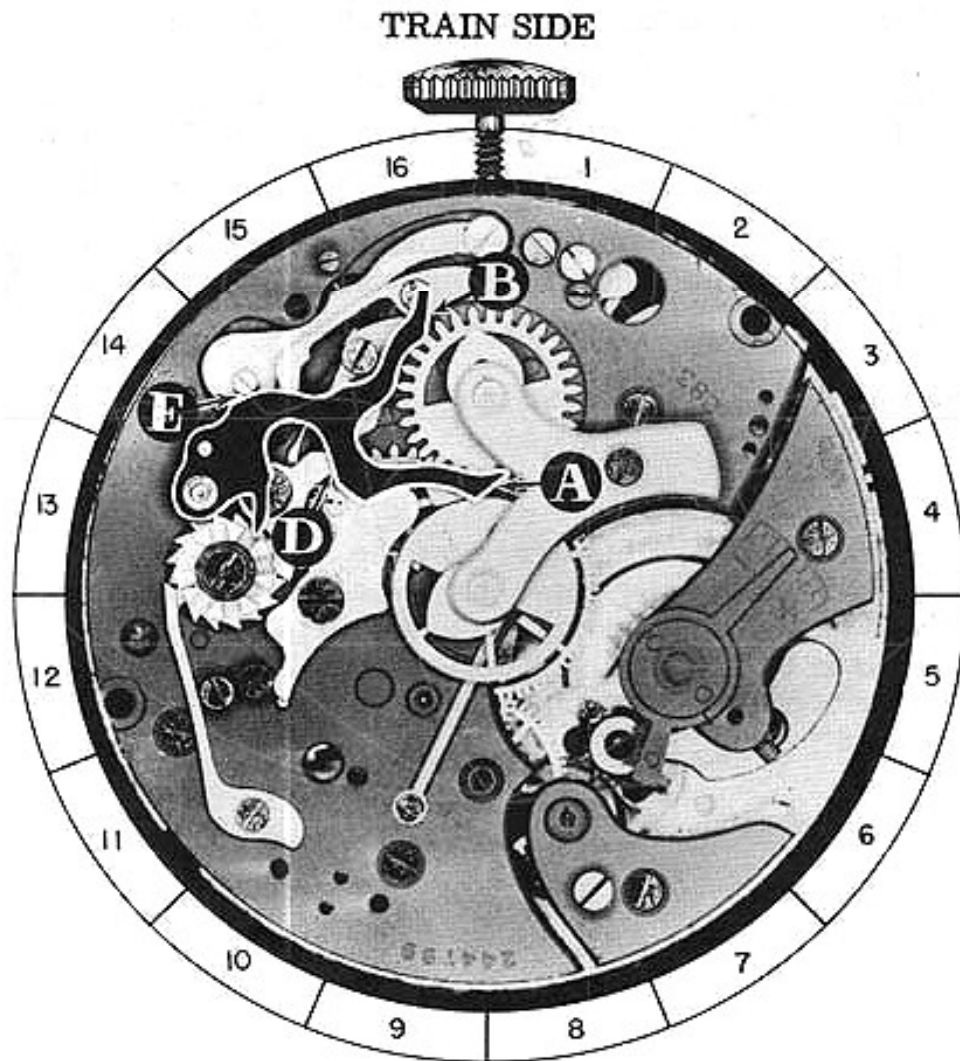

24-A

A. DISASSEMBLY PROCEDURE OF FLYBACK LEVER SPRING:

The flyback lever spring is held in place by beveled countersink screw BS-4 and a steady pin. Remove screw and loosen spring from plate with a thin blade screw-driver. After steady pin is free in plate, the spring may be lifted out of place.

(The shape of screw for this part is shown at bottom of page.)

B. ASSEMBLY PROCEDURE OF FLYBACK LEVER SPRING:

Place spring on movement with steady pin on spring in proper hole in plate. Now press spring down flush on plate with back of tweezers and replace beveled countersink screw BS-4.

C. FUNCTION OF FLYBACK LEVER SPRING:

The flyback lever spring serves two purposes:

1. The flyback lever spring holds the flyback lever in a negative position and will return the lever to this position after it has been moved manually.
2. The end "A" of flyback lever spring being hooked to screw on flyback lever naturally holds it in place, preventing flyback lever from working up and coming out of place.

REFERENCE: Flyback lever is Assembly 24.

REMARKS:

At this place, I would like to remind the repairer that it is important that in removing these parts the screw-driver and tweezers be sharpened correctly and the correct size of screw-driver blade be used for each screw slot. This will eliminate a lot of unnecessary breakage, marring of plates or screws, and loss of parts.



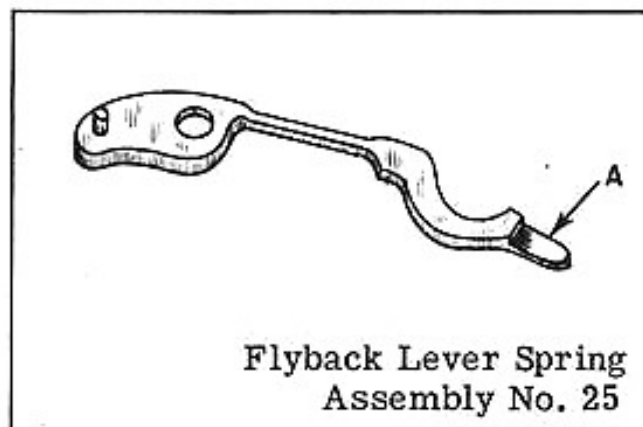

OILING

The flyback lever spring should not be oiled.

TRAIN SIDE

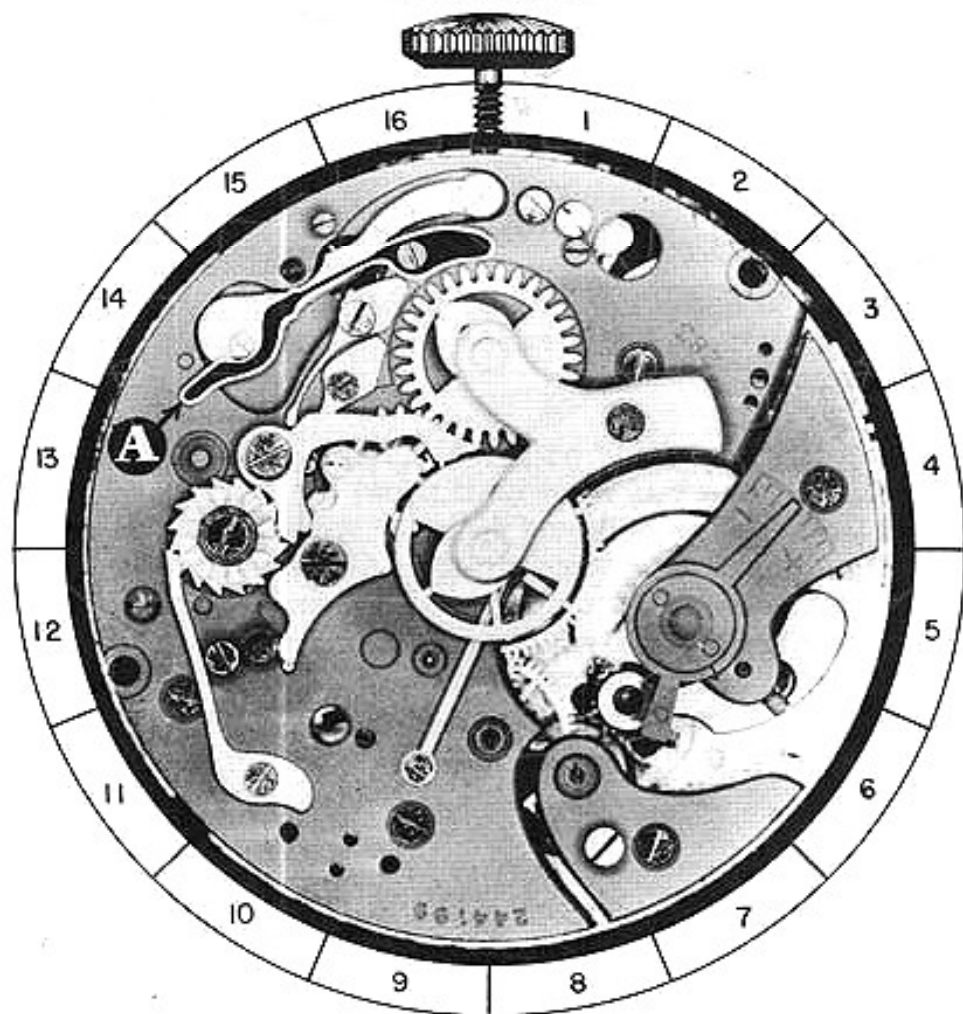

25-A

A. DISASSEMBLY PROCEDURE OF BRAKE LEVER SPRING:

The brake lever spring is held in place by fillister head screw FS-7 and a steady pin. Remove screw and loosen spring from plate with a thin blade screw-driver. When steady pin is free in plate, the spring may be lifted from watch.

(The shape of screw for this part is shown at bottom of page.)

B. ASSEMBLY PROCEDURE OF BRAKE LEVER SPRING:

Place brake lever spring on plate with steady pin on spring in hole in plate. Now press spring down in position and replace fillister head screw FS-7.

C. FUNCTION OF BRAKE LEVER SPRING:

The function of this spring is to hold a tension on the brake lever. This tension forces brake lever to contact seconds wheel when the brake is not disengaged by the chronograph.

REFERENCE: Brake lever is Assembly 27.
Seconds wheel is Assembly 31.

REMARKS:

This chronograph is a semi-instantaneous type of chronograph. It is possible to note immediately if the chronograph is a semi-instantaneous type by observation of the progress of the minute register hand.

The minute register hand on semi-instantaneous type of chronograph will remain stationary until about the 58th second of registration. Between the 58th and 60th second of registration, the hand will move forward very slowly. At the 60th second of registration, the minute register hand will move forward very quickly to complete the registration of one minute on the dial. Of course, the minute register hand progresses in the same manner for each consecutive minute of registration.

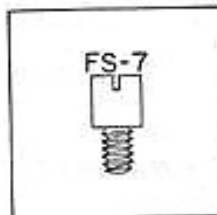

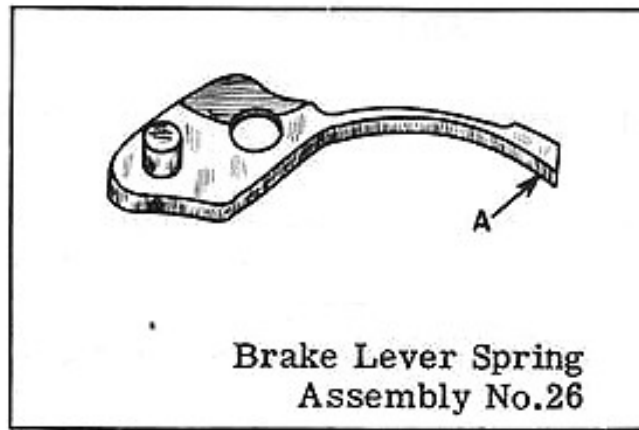

OILING

End "A" of brake lever spring should be slightly moistened with oil at point of contact with brake lever.

TRAIN SIDE

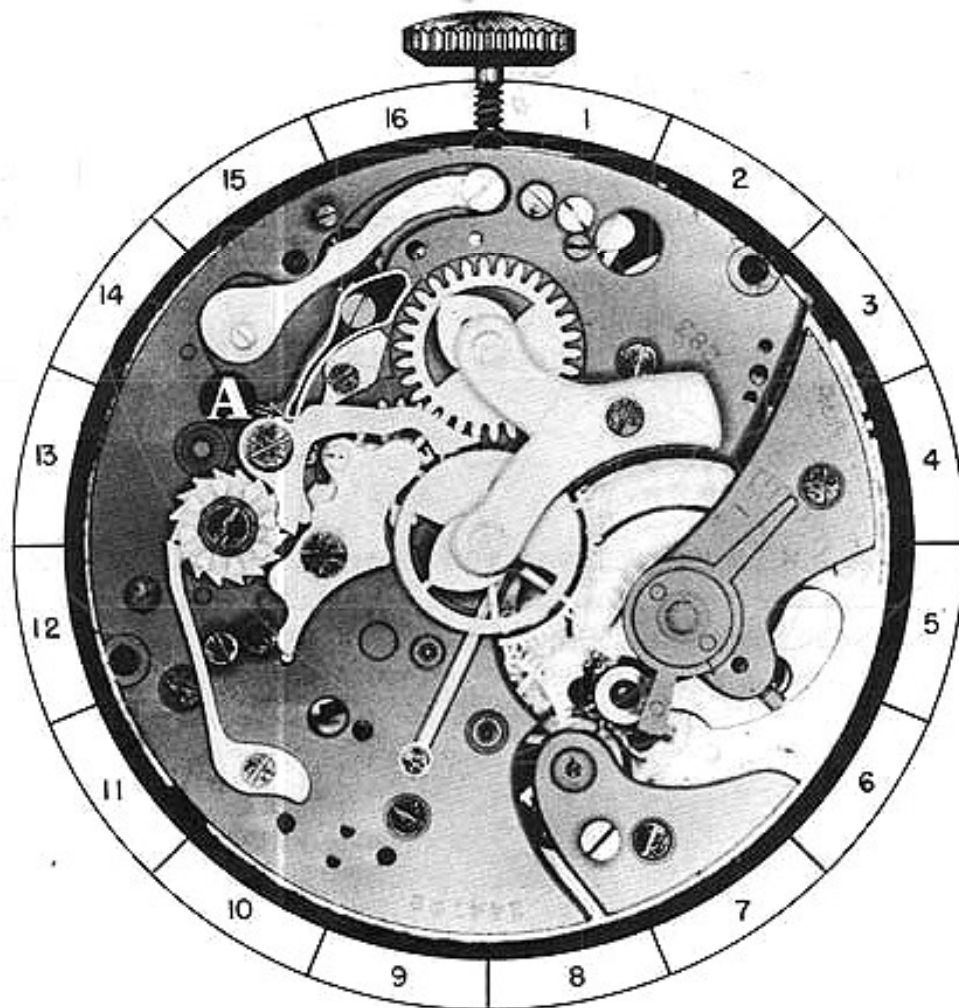

26-A

A. DISASSEMBLY PROCEDURE OF BRAKE LEVER:

The brake lever is held in place by shouldered screw SS-12. Remove screw and brake lever may be lifted from movement.

(The shape of screw for this part is shown at bottom of page.)

B. ASSEMBLY PROCEDURE OF BRAKE LEVER:

Place brake lever in its proper position on the plate with end "B" of brake lever contacting castle wheel. With brake lever in this position, replace shouldered screw SS-12. The brake lever should be checked to see that it pivots freely under the head of this screw.

C. FUNCTION OF BRAKE LEVER:

The function of the brake lever is to hold the seconds wheel in a stationary position when the seconds wheel is disengaged.

REFERENCE: Castle wheel is Assembly 36.
Seconds wheel is Assembly 31.

REMARKS:

When the intermittent lever and wheel assembly is forced away from the center of the watch, the surface on the intermittent lever contacts the brake lever at point "C". This forces the brake lever to disengage from the seconds wheel.

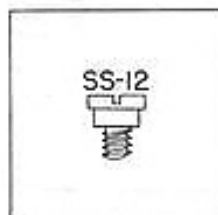

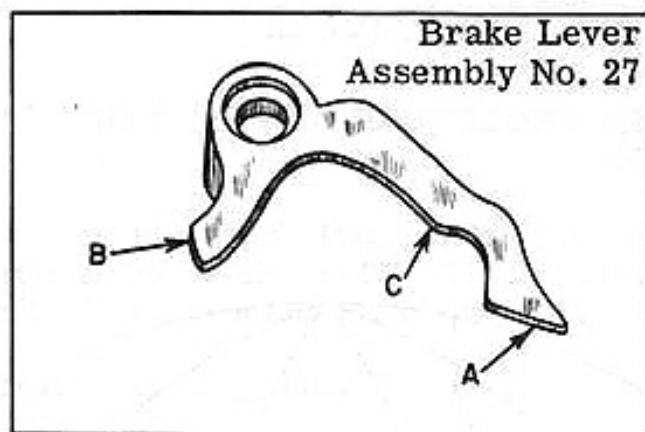

OILING

The following points on brake lever should be slightly moistened with oil:

1. Shoulder of screw on which brake lever pivots.
2. Surface "C" that contacts intermittent lever.

TRAIN SIDE

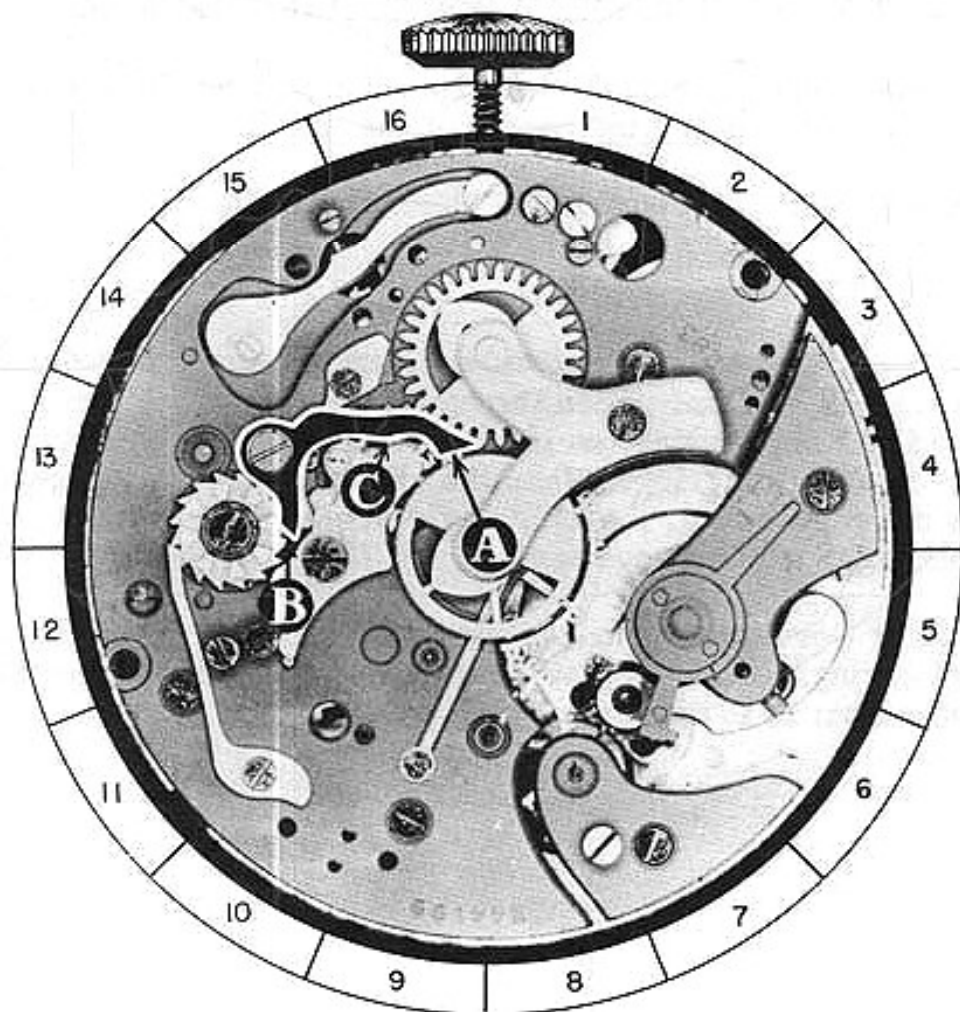

27-A

A. DISASSEMBLY PROCEDURE OF PUSH PIECE FOR SETTING BACK TO ZERO:

The push piece for setting back to zero is held in place by shouldered screw SS-13. When this screw is removed, push piece will be free on the plate and may be lifted out of place.

(The shape of screw for this part is shown at bottom of page.)

B. ASSEMBLY PROCEDURE OF PUSH PIECE FOR SETTING BACK TO ZERO:

Place push piece in position in recess in plate as shown in the photograph. Replace shouldered screw SS-13. After this screw is replaced, check the push piece to see that it pivots freely under the head of this screw.

C. FUNCTION OF PUSH PIECE FOR SETTING BACK TO ZERO:

The function of this push piece is, when pushed, to move the flyback lever toward the center of the watch.

REFERENCE: Flyback lever is Assembly 24.

REMARKS:

The hour register mechanism works in unison with the chronograph mechanism. When the chronograph mechanism is engaged and registering, so is the hour register mechanism engaged and registering. When the chronograph is disengaged and not registering, the hour register mechanism must be disengaged and not registering.

In other words, the hour register mechanism is not always registering. It only registers the hours that the chronograph mechanism is in operation.

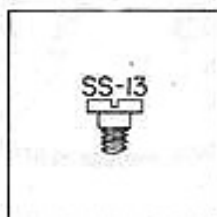

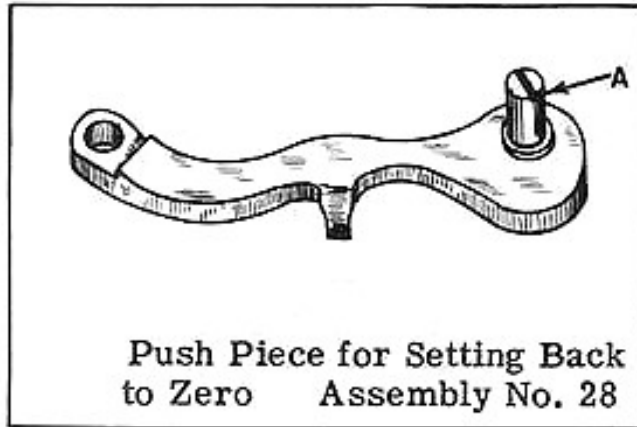

OILING

The shoulder of screw on which push piece for setting back to zero pivots should be slightly moistened with oil.

TRAIN SIDE

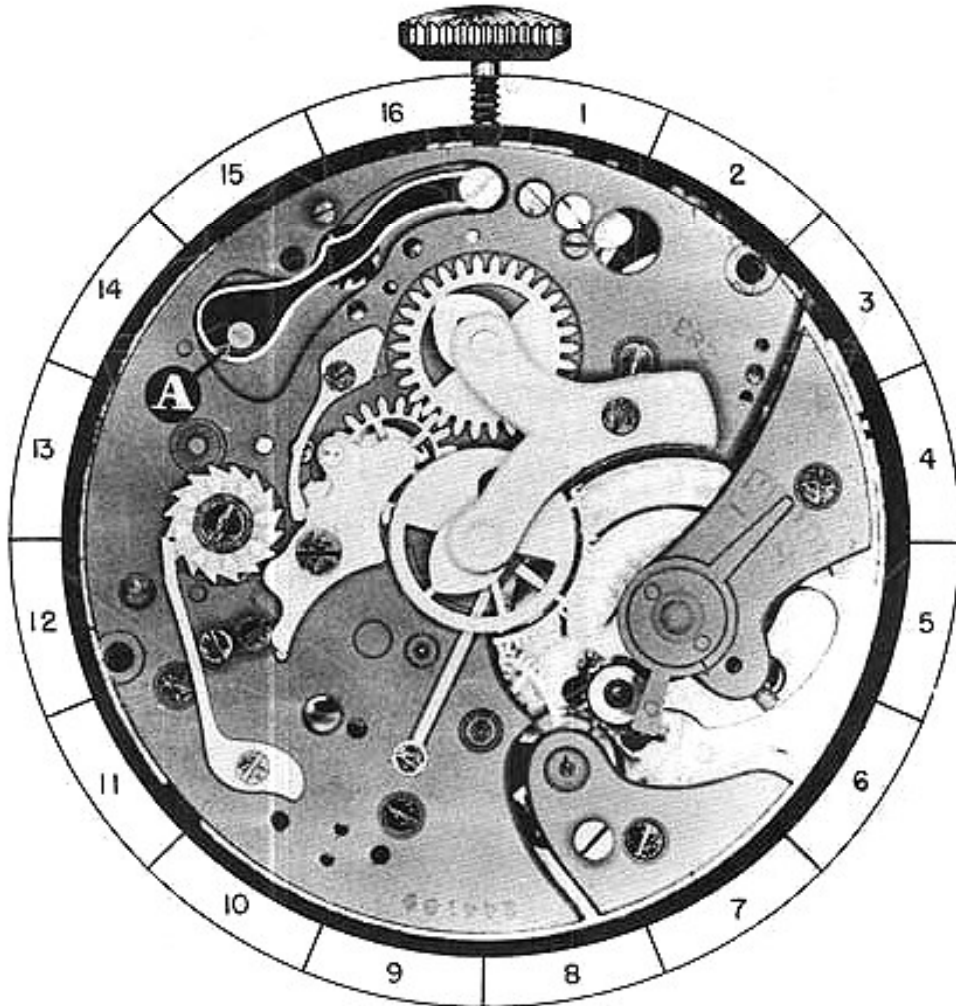

28-A

A. DISASSEMBLY PROCEDURE OF SECONDS WHEEL AND MINUTE REGISTER WHEEL BRIDGE:

This bridge is held in place by fillister head screw FS-8 and steady pins. Remove screw and loosen bridge from plate by sliding a thin blade screw-driver between bridge and plate. When steady pins are free in plate, bridge may be lifted out of place.

(The shape of screw for this part is shown at bottom of page.)

B. HAZARDS IN DISASSEMBLY OF SECONDS WHEEL AND MINUTE REGISTER WHEEL BRIDGE:

When removing bridge from plate, avoid twisting of bridge, as this may damage pivots on wheels or may chip the jewels in the bridge. The screw-drivers should be carefully used to prevent marring of bridge or plate.

C. ASSEMBLY PROCEDURE OF SECONDS WHEEL AND MINUTE REGISTER WHEEL BRIDGE:

Place bridge on plate with steady pins over proper holes in plate. Place top pivot of seconds wheel and minute register wheel so they will enter the jewel holes in bridge. Bridge may now be pressed down to proper place with back of tweezers and fillister head screw FS-8 replaced.

REFERENCE: Seconds wheel is Assembly 31.
Minute register wheel is Assembly 30.

D. FUNCTION OF SECONDS WHEEL AND MINUTE REGISTER WHEEL BRIDGE:

The function of this bridge is to hold top pivots of seconds wheel and minute register wheel in position so these wheels can function properly.

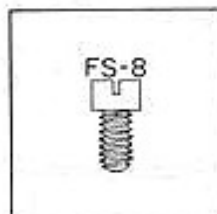

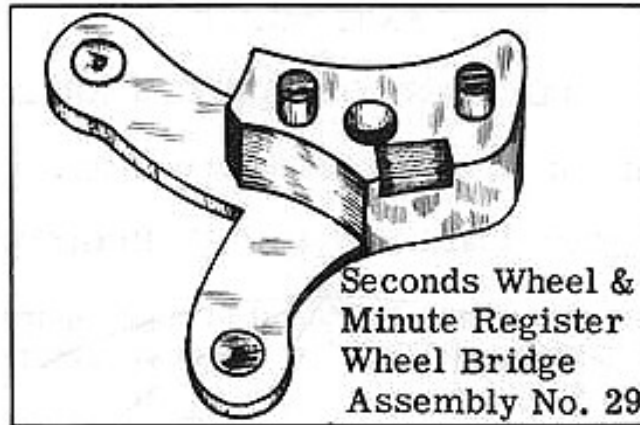

OILING

The pivots in the jewels in this bridge should be oiled as you usually oil the train pivots in a watch.

TRAIN SIDE

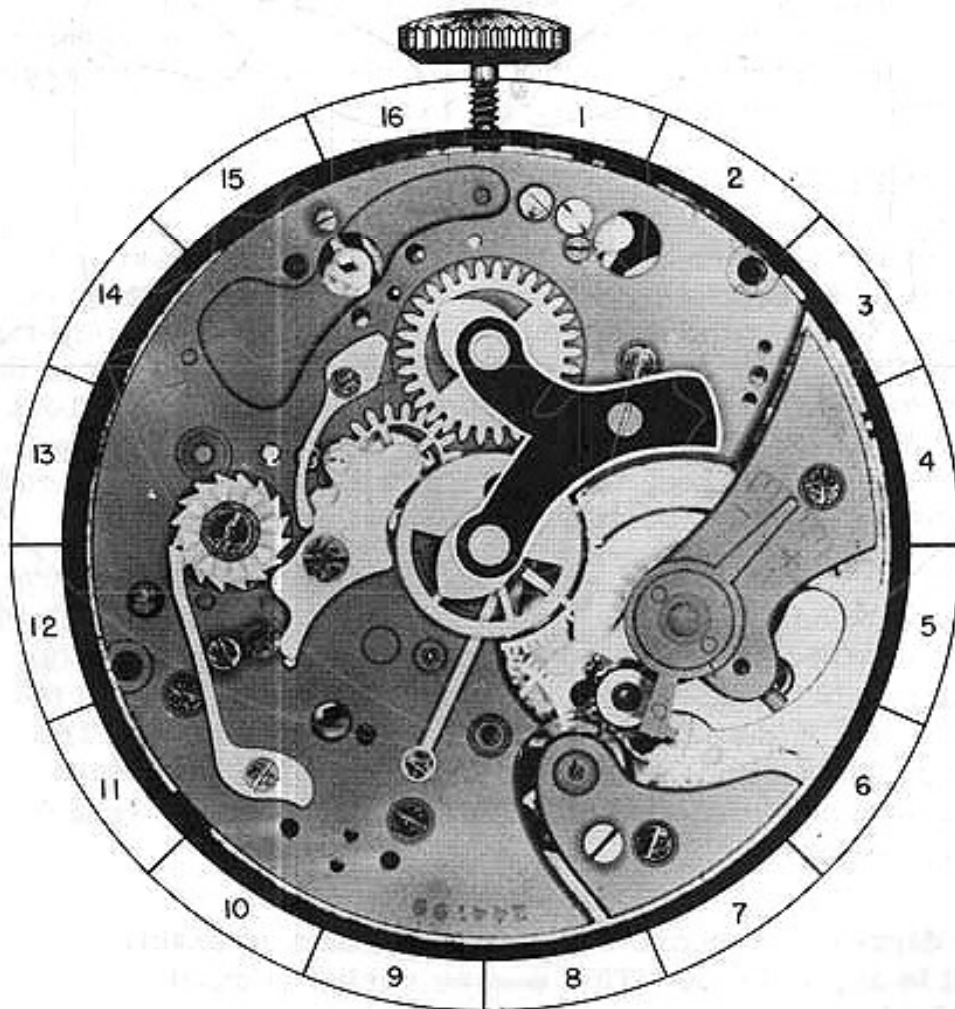

29-A

A. DISASSEMBLY PROCEDURE OF MINUTE REGISTER WHEEL:

To remove this wheel, simply lift it out of place.

B. HAZARDS IN DISASSEMBLY OF MINUTE REGISTER WHEEL:

When removing this wheel, lift wheel straight up out of watch, as any twisting may bend or break the pivot on the minute register wheel.

C. ASSEMBLY PROCEDURE OF MINUTE REGISTER WHEEL:

Place the minute register wheel in its proper position in the watch as shown in the photograph. The long pivot "A" on this wheel must go down in watch.

D. FUNCTION OF MINUTE REGISTER WHEEL:

The function of the minute register wheel is to record the minutes since the beginning of the registration of the chronograph sweep second hand. The heart "B" on the minute register wheel is used in returning the hand to zero.

REMARKS:

The minute register hand is returned to zero position by the flyback lever contacting the heart "B" on minute register wheel. The heart on this wheel is set eccentric. When the flat end of flyback lever contacts this eccentric heart, it forces the heart to turn. The heart will turn until the flat end of flyback lever sets across the two lobes at top of heart. With the pressure equalized at these two points, it will turn no further, and this would be a zero position.

If this wheel has turned less than 160 degrees from a zero position when the flyback lever is brought in contact with the heart, it will turn in the opposite direction to which it was turning to bring this wheel back to a zero position. On the other hand, if the wheel is turned passed 160 degrees from a zero position, the flyback lever will force the heart to continue to turn in the direction it was turning until it reaches a zero position.

The degree used above should not be taken as exactly correct, as it is approximate. This degree varies in most chronographs from 150 degrees to 170 degrees.

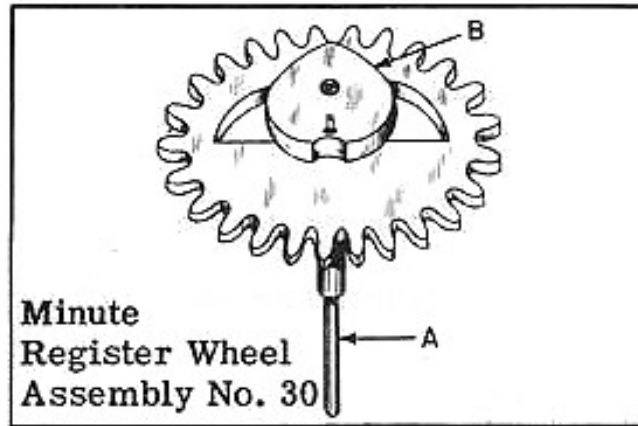

OILING

The bottom pivot on minute register wheel should be oiled before placing this wheel in watch. The top pivot is oiled after bridge for this wheel is placed in watch.

TRAIN SIDE

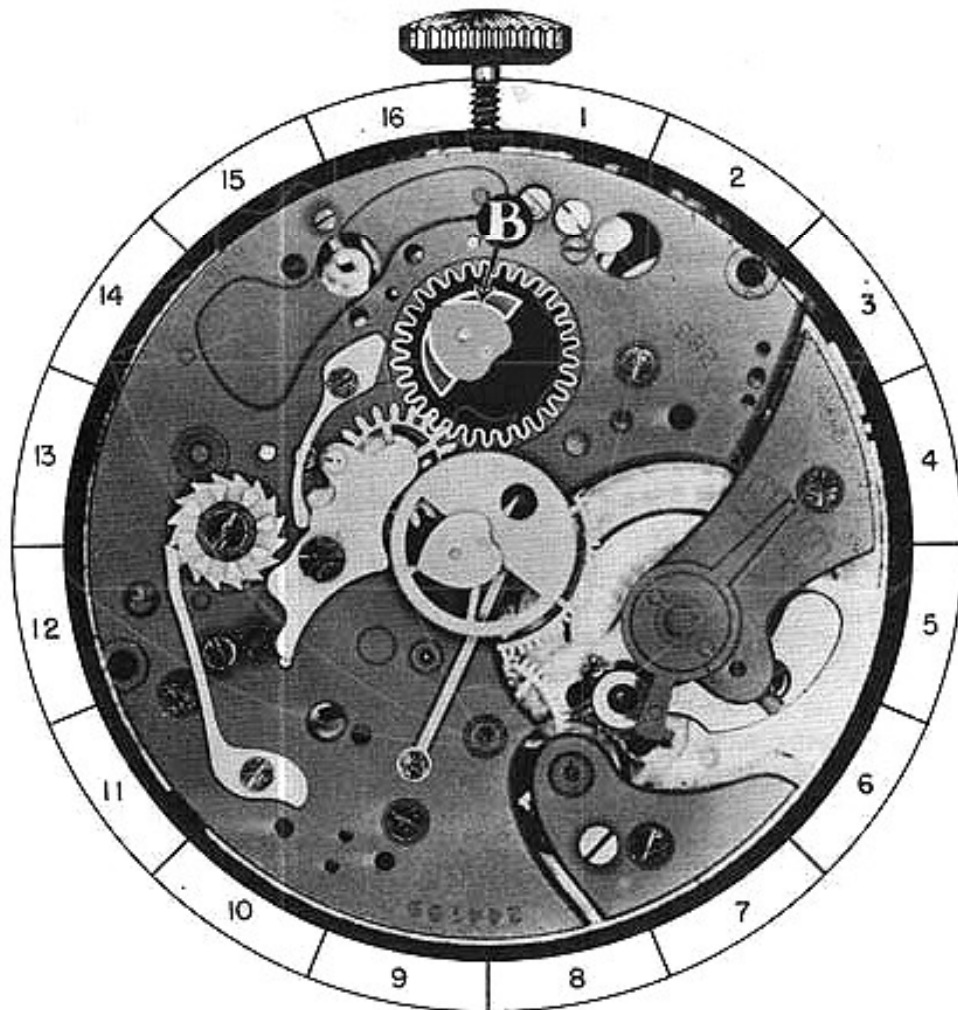

30-A

A. DISASSEMBLY PROCEDURE OF SECONDS WHEEL:

The seconds wheel is lifted out of place to remove it.

B. ASSEMBLY PROCEDURE OF SECONDS WHEEL:

Place wheel in its proper position with the long pivot "A" down in hole in center wheel pinion.

C. FUNCTION OF SECONDS WHEEL:

The function of the seconds wheel is to do three things:

1. It registers the passage of seconds on the dial. This is done by a hand being attached to the long pivot "A" on seconds wheel.
2. The seconds wheel must move the minute register wheel forward one tooth each time the seconds wheel makes one revolution. This is done by a dart tooth "C" attached to the seconds wheel. This dart tooth meshes with the teeth on the intermittent wheel which, in turn, moves the minute register wheel one tooth.
3. The seconds wheel must return to a zero position when the flyback lever is brought in contact with the heart on this wheel. The seconds wheel heart is shown as "B" in the isometric drawing.

REFERENCE: Flyback lever is Assembly 24.
Intermittent lever and wheel assembly is
Assembly 34.

REMARKS:

When the flyback lever is forced toward the center of the watch and held in this position, check the seconds wheel and minute register wheel to see if either of these wheels will turn. The minute register wheel should turn slightly at this point, but the seconds wheel should be held very tight by the flyback lever. It is most essential for the seconds wheel to be held stationary by the flyback lever at a zero position. In the case of the minute register wheel, it does not have to be held absolutely stationary by the flyback lever. The minute register pawl will serve this purpose. The only thing the minute register wheel should be checked for is to see that the minute register wheel will not turn far enough to one side or the other to let the minute register pawl drop between another tooth. This will insure that the minute register wheel will always be brought back to a zero position.

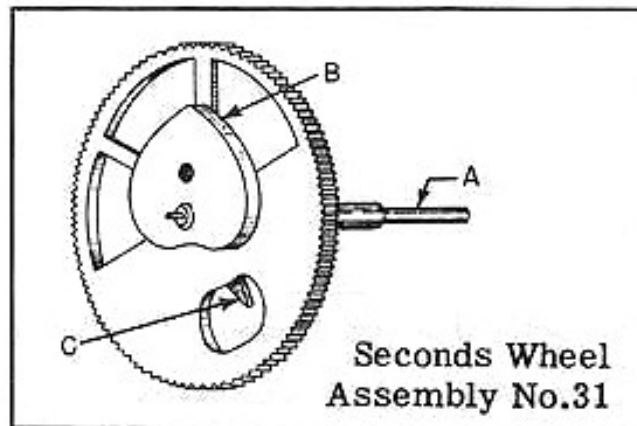

OILING

The top pivot on seconds wheel should be oiled after bridge for this wheel is replaced. Oil this pivot as you usually oil a train pivot in a watch.

TRAIN SIDE

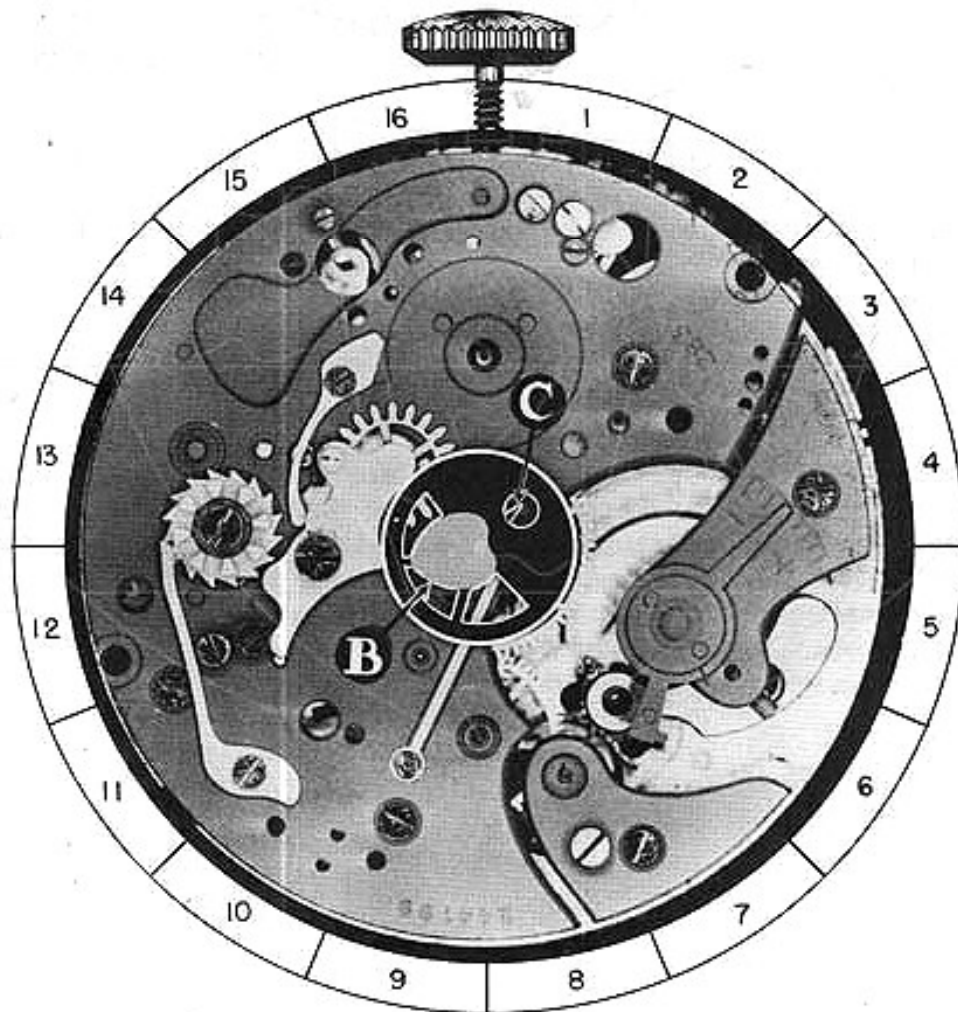

31-A

A. DISASSEMBLY PROCEDURE OF SECONDS WHEEL TENSION SPRING:

The seconds wheel tension spring is held in place by fillister head screw FS-9. After this screw is removed, the spring will be free on the plate and may be lifted out of place.

(The shape of screw for this part is shown at bottom of page.)

B. ASSEMBLY PROCEDURE OF SECONDS WHEEL TENSION SPRING:

Place seconds wheel tension spring in its proper position with hole in spring over proper hole in plate. Replace fillister head screw FS-9 but before tightening screw, make sure that end "A" of spring is not over seconds wheel hole. End "A" of this spring should fit right along side of center wheel pivot hole. It should not fit over it. The proper position of this spring is shown in the photograph. After spring is replaced and screw is tight, check to make sure that this tension spring is still in its proper position as shown in the photograph. This spring should also be checked to see that it is right side up. The only way to determine the side that should be up is to see that end "A" of spring is above the level of the plate and the polished side of spring is facing up.

C. FUNCTION OF SECONDS WHEEL TENSION SPRING:

This spring holds a tension on seconds wheel to keep it turning with an even action with no irregular jumping or jerking.

REFERENCE: Seconds wheel is Assembly 31.

REMARKS:

When replacing this spring, end "A" of spring must be in its proper position. This is to prevent any contact of the spring with the seconds wheel staff. It is important to see that end "A" of spring is in its proper position. If it is not, this end of spring may hold a tension on the seconds wheel staff causing excess friction on this part which may cause the watch to stop. The seconds wheel tension spring should only hold an upward tension on seconds wheel.

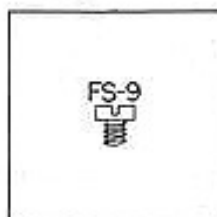

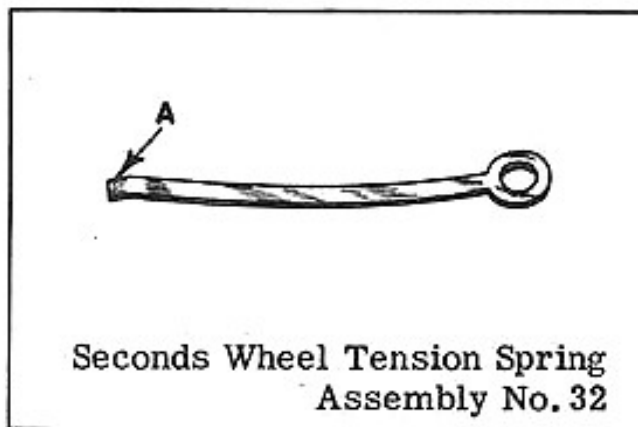

OILING

The seconds wheel tension spring should not be oiled.

TRAIN SIDE

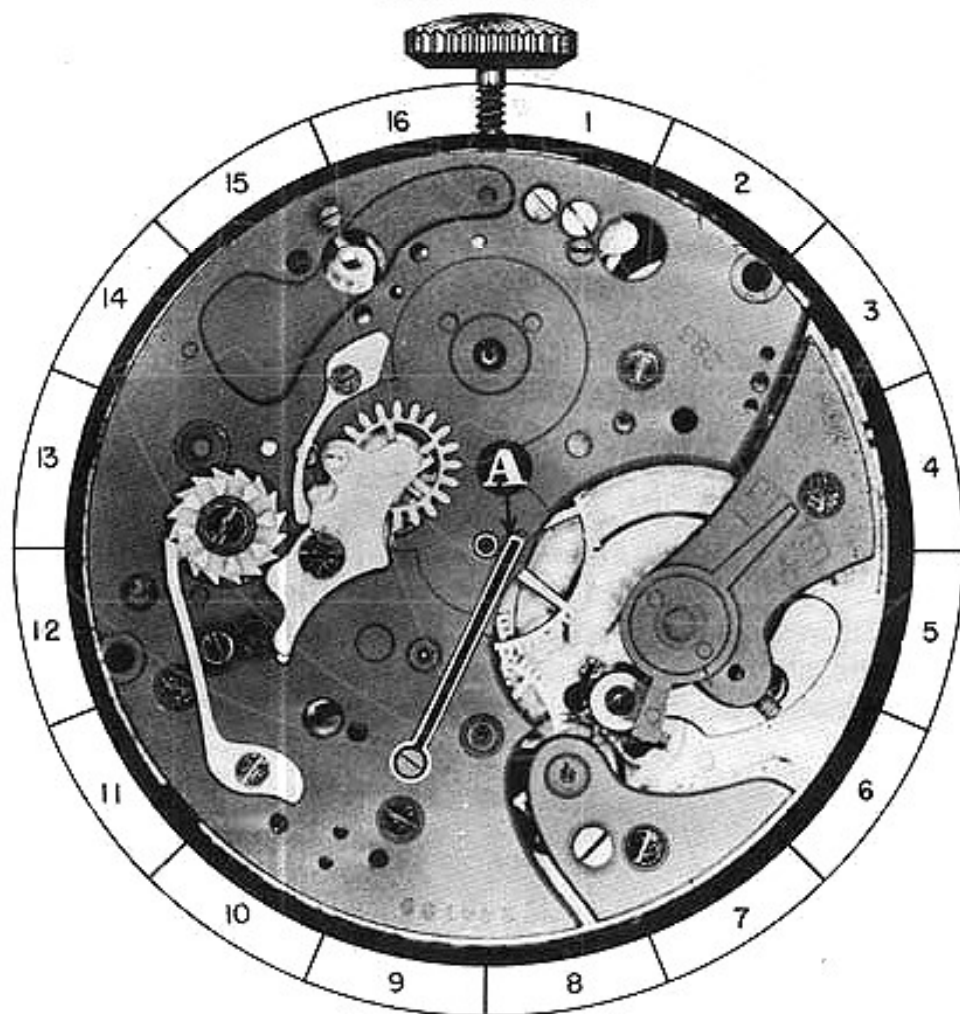

32-A

A. DISASSEMBLY PROCEDURE OF INTERMITTENT LEVER SPRING:

This spring is held in place by beveled countersink screw BS-5 and a steady pin. Remove screw and loosen spring from plate by sliding a thin blade screw-driver under spring. When steady pin is free in plate, spring may be lifted out of place.

(The shape of screw for this part is shown at bottom of page.)

B. ASSEMBLY PROCEDURE OF INTERMITTENT LEVER SPRING:

Place spring in position on plate with steady pin over proper hole in plate. Now press spring down flush on plate and replace beveled countersink screw BS-5.

C. FUNCTION OF INTERMITTENT LEVER SPRING:

The function of this spring is to hold a tension on intermittent lever. This tension forces intermittent lever to engage intermittent wheel with the seconds wheel dart tooth.

REFERENCE: Intermittent lever and wheel assembly is Assembly 34.
Intermittent wheel is Assembly 34A.
Seconds wheel dart tooth is Assembly 31C.

REMARKS:

Each part that should move freely under head of the shouldered screw should be checked for the required freedom desired on that part. Any excess freedom to the point that the part is sloppy is not desired. In the case where a part has too much vertical movement or endshake under the head of the shouldered screw, the shoulder on the screw may be too long. To correct this, cut back the shoulder on the screw reducing the length of it.



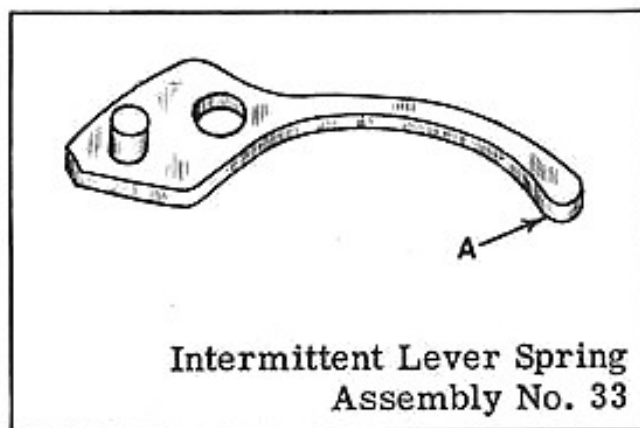

OILING

End "A" of intermittent lever spring should be slightly moistened with oil at point of contact with intermittent lever.

TRAIN SIDE

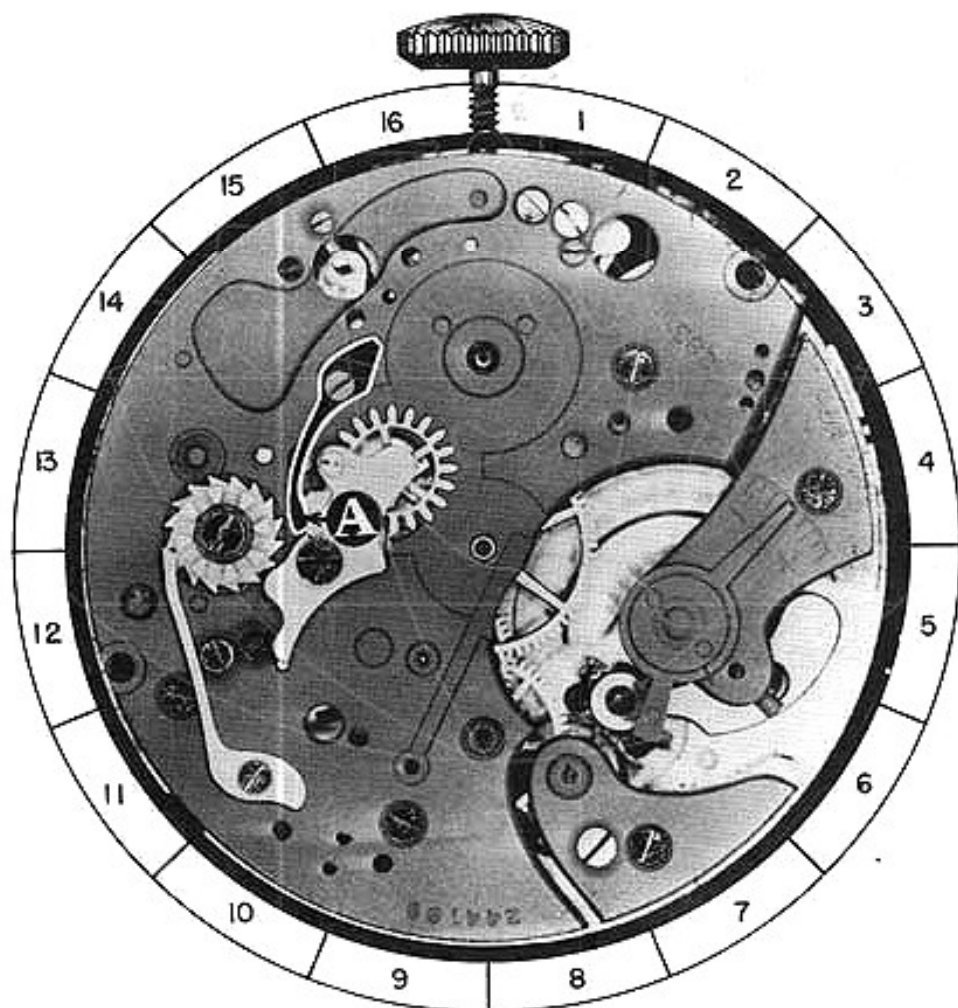

33-A

A. DISASSEMBLY PROCEDURE OF INTERMITTENT LEVER AND WHEEL ASSEMBLY:

This lever is held in place by shouldered screw SS-14. Remove screw and intermittent lever and wheel assembly will be free on plate and can be lifted out of place.

(The shape of screw for this part is shown at bottom of page.)

Disassembly procedure of the intermittent lever bridge and intermittent lever wheel is shown on the next page.

B. ASSEMBLY PROCEDURE OF INTERMITTENT LEVER AND WHEEL ASSEMBLY:

Place intermittent lever in position on plate and replace shouldered screw SS-14. After this screw is replaced, check to see that intermittent lever and wheel assembly pivots freely under the head of this screw.

C. FUNCTION OF INTERMITTENT LEVER AND WHEEL ASSEMBLY:

The function of the intermittent lever is to engage and disengage the intermittent wheel with the seconds wheel dart tooth.

REFERENCE: Seconds wheel dart tooth is Assembly 31-C.

REMARKS:

When the flyback lever is forced toward the center of the watch, it contacts screw "B" on the intermittent lever and wheel assembly, thus disengaging the intermittent wheel "A" from the seconds wheel dart tooth. This must be done so that the flyback lever can bring the seconds wheel back to a zero position without the dart tooth on seconds wheel contacting the intermittent wheel.

REFERENCE: Flyback lever is Assembly 24.
Seconds wheel is Assembly 31.

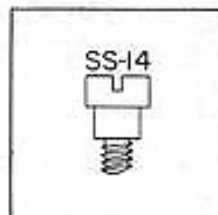

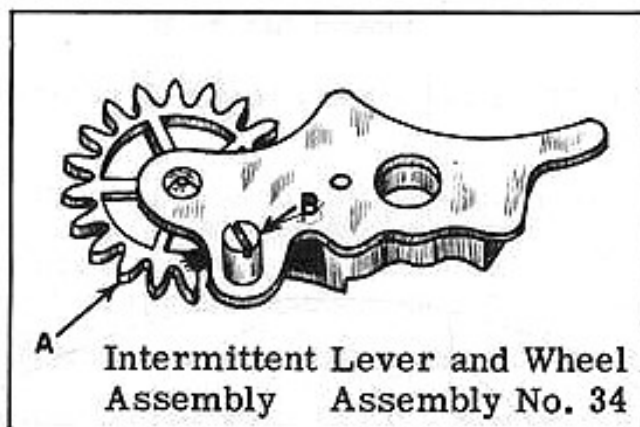

OILING

The shoulder of screw on which the intermittent lever pivots should be slightly moistened with oil.

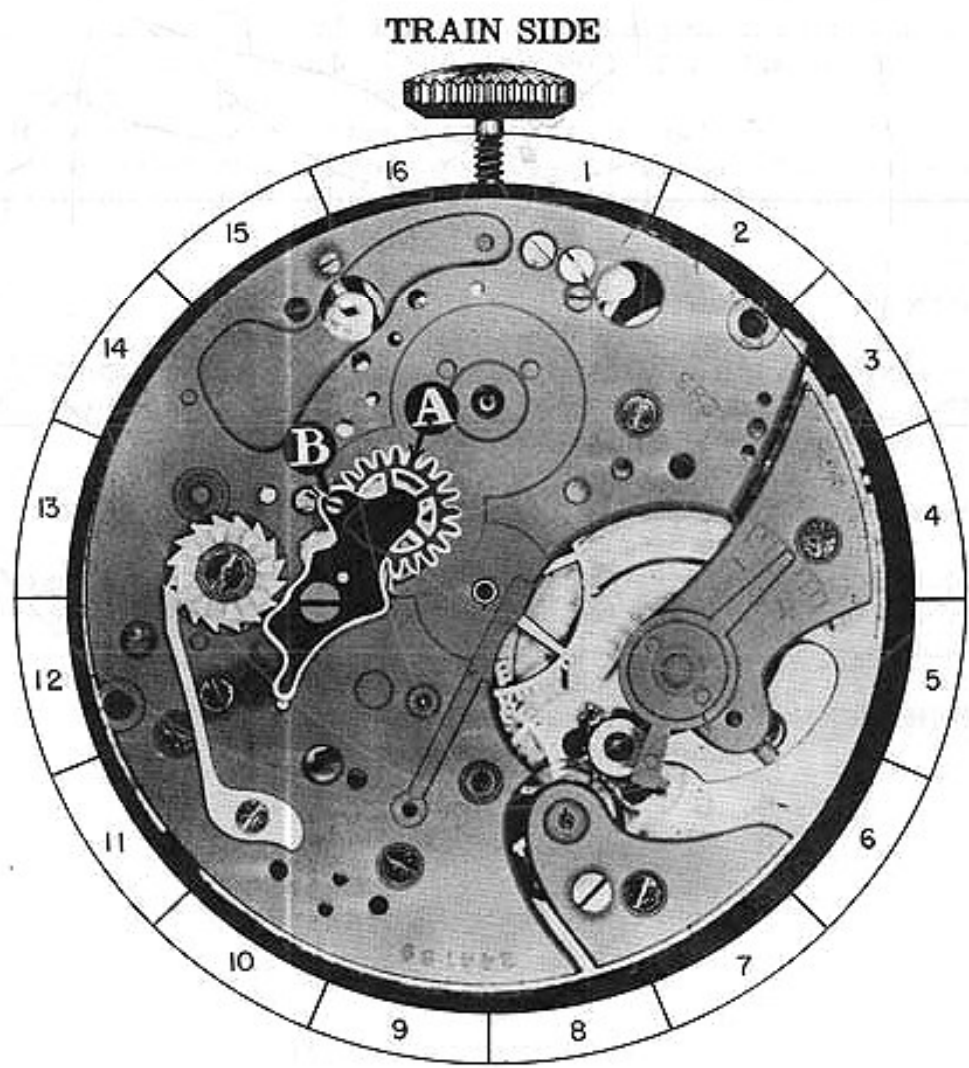

A. DISASSEMBLY PROCEDURE OF INTERMITTENT WHEEL AND BRIDGE:

This bridge is held in place by fillister head screw FS-10 and steady pins. When this screw is removed, the bridge can be lifted out of place and free from intermittent lever. After bridge is removed, the intermittent wheel can be lifted out of place with a pair of tweezers.

(The shape of screw for this part is shown at bottom of page.)

B. HAZARDS IN DISASSEMBLY OF INTERMITTENT WHEEL AND BRIDGE:

When removing this wheel, lift wheel straight out of place without tilting it, as any tilting of this wheel may bend or break the pivot on this wheel.

C. ASSEMBLY PROCEDURE OF INTERMITTENT WHEEL AND BRIDGE:

Place the intermittent wheel with the pivot "A" on wheel in pivot hole in the intermittent lever. Now place the bridge on the intermittent lever with steady pins on intermittent lever entering proper holes in bridge. Make sure that the intermittent wheel pivot is entering pivot hole in intermittent lever bridge. Now press bridge down to proper place and replace fillister head screw FS-10 which holds this bridge in place.

REMARKS:

After the bridge is replaced, check the intermittent wheel to see that it pivots freely and is not binding. Also check this wheel to see that it has proper endshake.

D. FUNCTION OF INTERMITTENT WHEEL AND BRIDGE:

The function of the intermittent wheel is to move the minute register wheel one tooth each time the dart tooth on seconds wheel makes one revolution.

REFERENCE: Minute register wheel is Assembly 30.
Seconds wheel is Assembly 31.

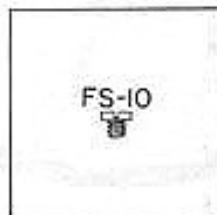

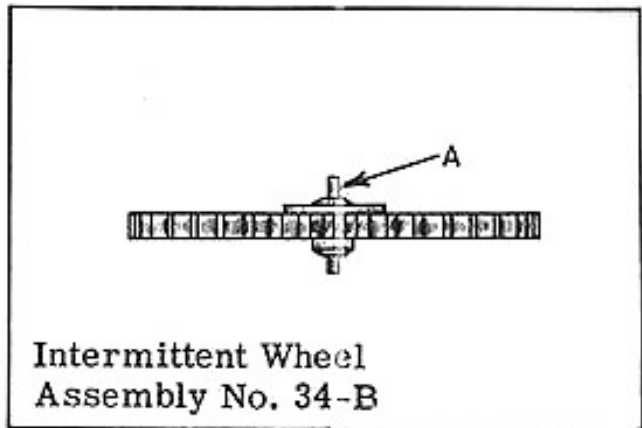

OILING

The intermittent wheel should not be oiled.

TRAIN SIDE

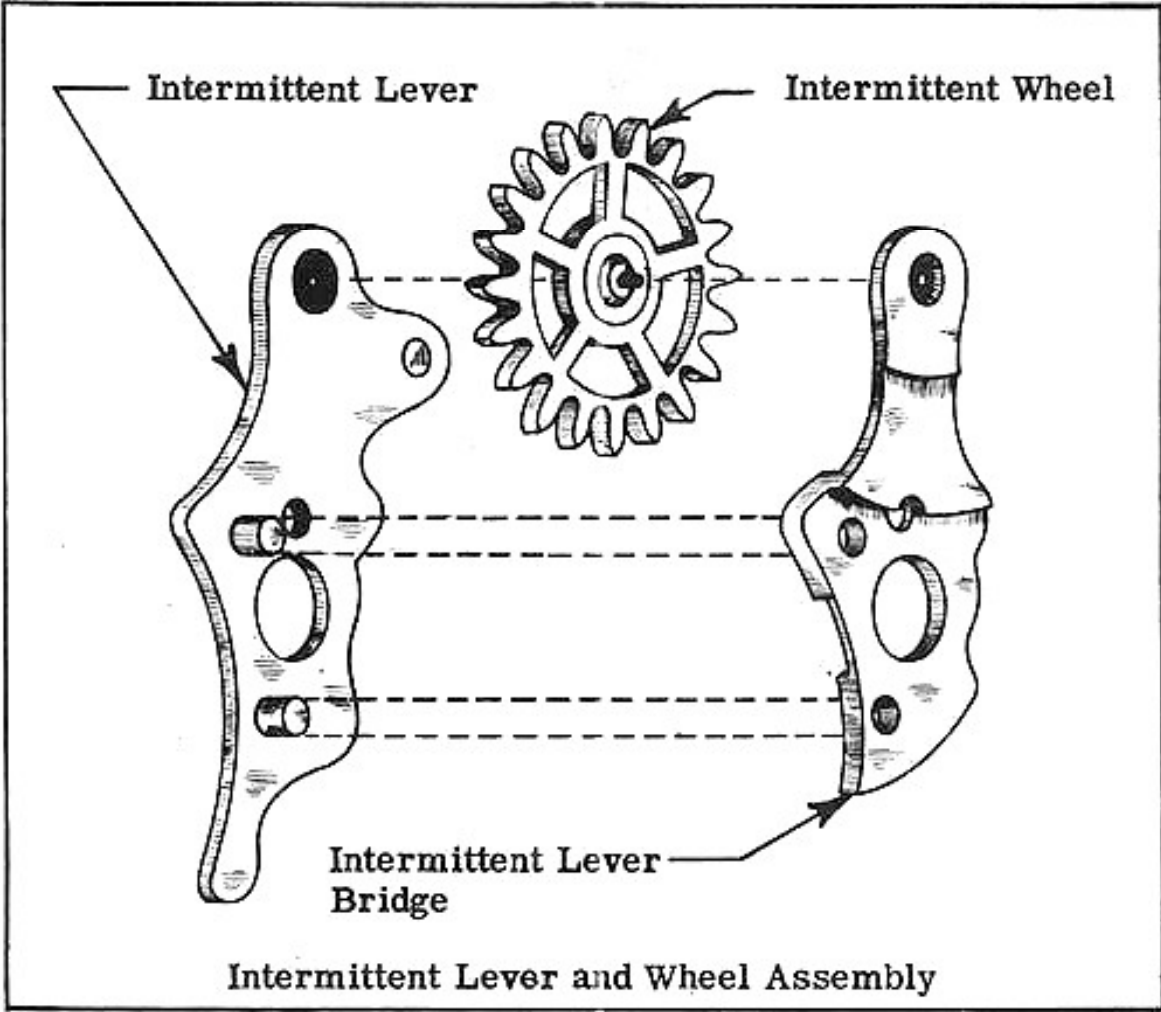

A. DISASSEMBLY PROCEDURE OF CASTLE WHEEL PAWL:

This pawl is held in place by fillister head screw FS-11 and steady pins. When this screw is removed, pawl can be loosened from plate by sliding a thin blade screw-driver under pawl. After steady pins are free in plate, this pawl can be lifted out of place.

(The shape of screw for this part is shown at bottom of page.)

B. ASSEMBLY PROCEDURE OF CASTLE WHEEL PAWL:

Place pawl in its proper position on the plate with steady pins in proper holes in plate. Now press pawl down in proper place. Make sure that end "A" of pawl is not on top of ratchet teeth of castle wheel but meshing in between two teeth on this wheel. To function properly, end "A" of pawl must be engaged with the ratchet teeth on the castle wheel. Now replace fillister head screw FS-11 that holds this pawl in place.

REFERENCE: Castle wheel is Assembly 36.

C. FUNCTION OF CASTLE WHEEL PAWL:

The function of the castle wheel pawl is to do two things:

1. This pawl correctly spaces the turning of the castle wheel. This eliminates the possibility of the castle wheel setting at an incorrect position.
2. It holds the castle wheel in position until it is moved manually.

REFERENCE: Castle wheel is Assembly 36.

The ratchet teeth on castle wheel is shown as "B" in the isometric drawing.

REMARKS:

The end "A" of castle wheel pawl should be highly polished. Any roughness or pits of rust at this location may cause the pawl not to function properly. If it is necessary to polish this part, care should be taken not to change the shape of the end "A" of pawl. It must be of correct shape to function properly as stated above.



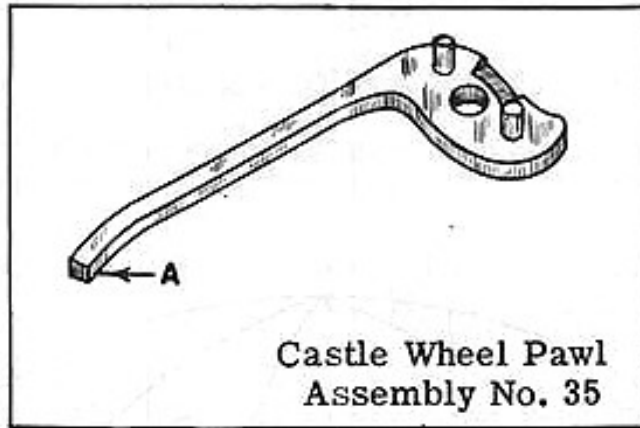

OILING

The castle wheel pawl should not be oiled.

TRAIN SIDE

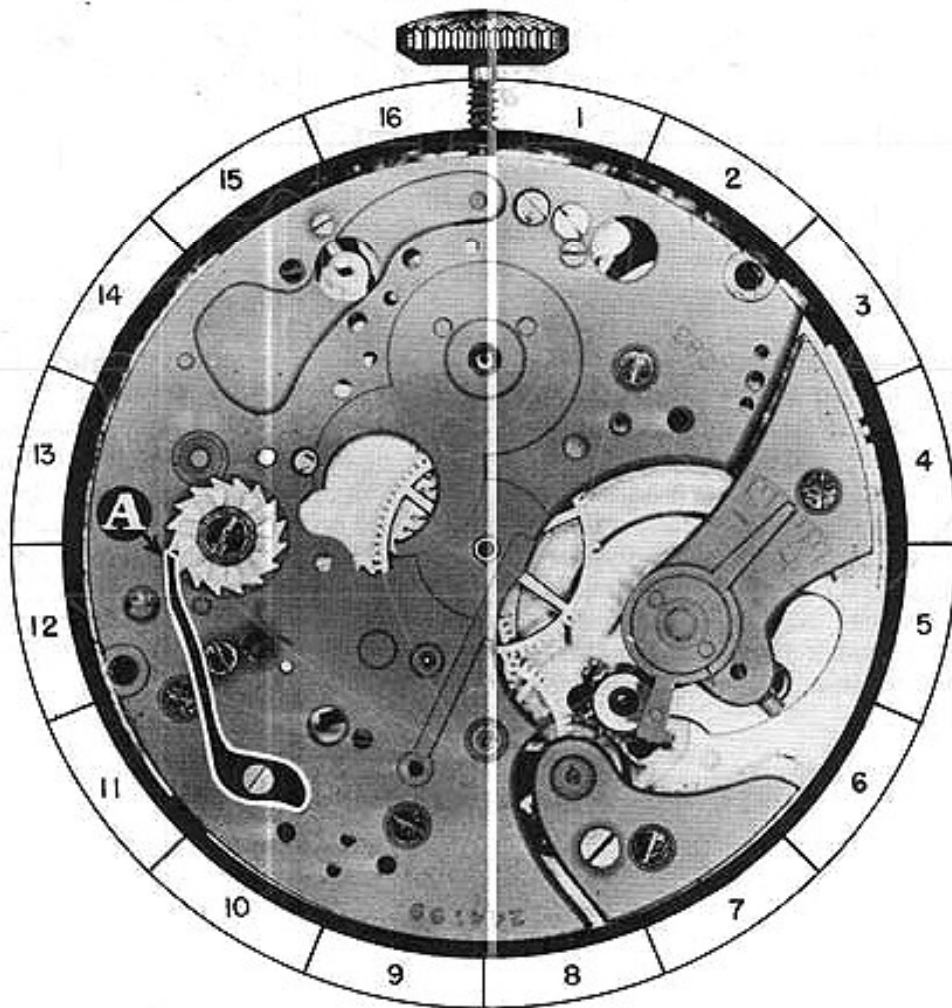

35-A

A. DISASSEMBLY PROCEDURE OF CASTLE WHEEL:

The castle wheel is held in place by shouldered screw SS-15. After this screw is removed, the castle wheel will be free on plate and can be lifted out of place.

(The shape of screw for this part is shown at bottom of page.)

B. ASSEMBLY PROCEDURE OF CASTLE WHEEL:

Place the castle wheel in its proper position on the plate as shown in the photograph. Replace shouldered screw SS-15 that holds this wheel in place. Check to see that it turns freely under the head of this screw. Of course, this wheel should not have excess freedom to the point that it is fitted sloppy.

C. FUNCTION OF CASTLE WHEEL:

The function of the castle wheel is to do three things:

1. It disengages the intermediary wheel from the seconds wheel.
2. It disengages the brake lever from the seconds wheel.
3. It prevents the flyback lever from being moved toward the center of the watch when the chronograph mechanism is engaged.

REFERENCE: Intermediary wheel is Assembly 19.
Seconds wheel is Assembly 31.
Flyback lever is Assembly 24.
Brake lever is Assembly 27.

REMARKS:

The castle wheel performs its functions by the columns "A" which are evenly spaced around the center of the wheel. As the castle wheel is turned, the columns either force the part to move out from the center of the castle wheel or permit it to move in to the empty space between the two columns. For example, the intermediary wheel is disengaged from the seconds wheel by the columns of the castle wheel forcing the end of the chronograph pivoted detent from between the columns until the point of this lever rests on the column. To engage the intermediary wheel with the seconds wheel, the castle wheel is turned one space. This permits end of chronograph pivoted detent to enter the empty space between the columns which permits the two wheels to be engaged by the chronograph pivoted detent.

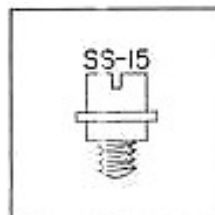

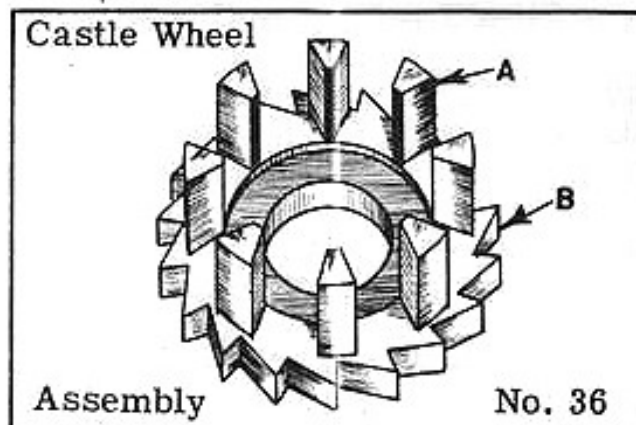

OILING

Slightly moisten the castle wheel with oil at these points:

1. Shoulder of screw on which castle wheel pivots
2. The columns "A" that contact parts of this mechanism
3. The castle wheel ratchet teeth "B".

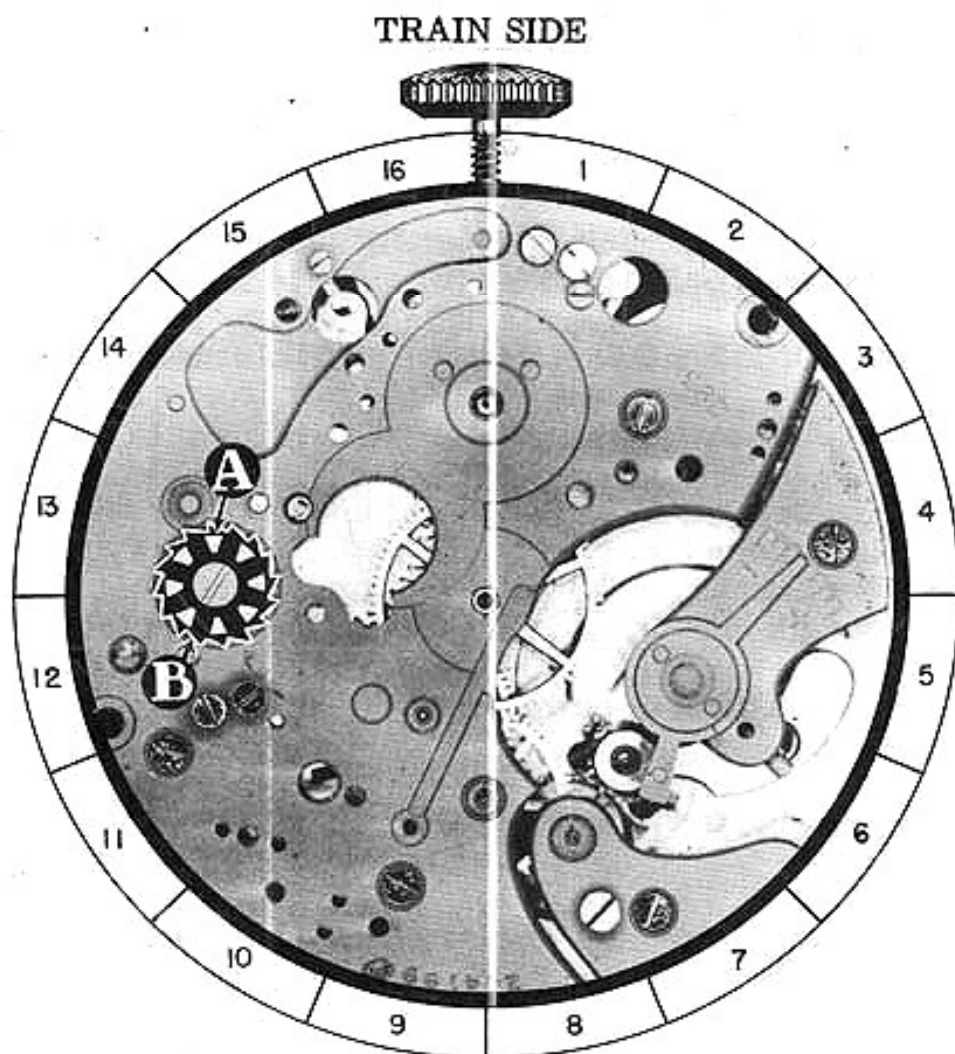

36 A

FUNCTIONAL RESULTS

After chronograph has been completely assembled with the exception of dial, hands, bezel, and back of case, place the chronograph in front of you, pendant up with dial side facing you.

1. Push button at bottom of case that moves the date wheel, hold in this position, and check the following:

- A. Check to see that the date wheel moves forward one tooth each time this button is pushed.

CORRECTION: The following errors could prevent the date wheel moving forward one tooth each time the date setting button is pushed:

1. The date wheel binding and not pivoting freely.
2. The date setting detent lever binding and not pivoting freely.
3. The date wheel pawl not holding enough tension on date wheel.

2. Release date setting button and check the following:

- A. Check to see that date wheel setting detent lever returns to its original position.

CORRECTION: The following errors could prevent the date wheel setting detent lever from returning to its original position:

1. The date wheel setting detent lever binding and not pivoting freely.
2. The date wheel setting detent lever spring not holding enough tension on date wheel setting detent lever.

3. Push button at right of pendant, hold in this position, and check the following:

(Make sure castle wheel is in correct position so button can be pushed)

- A. Check to see that hour register wheel has returned to a zero position.

(Continued on next page)

FUNCTIONAL RESULTS
(Continued)

CORRECTION: The following errors could prevent the hour register wheel from returning to a zero position:

1. Hour register wheel binding and not pivoting freely.
2. Hour flyback lever binding and not forcing this wheel to return to zero.

4. Release button and check the following:

A. Check to see that hour flyback lever returns to its original position.

CORRECTION: The following errors could prevent the hour flyback lever from returning to its original position:

1. Hour flyback lever binding and not pivoting freely.
2. Hour flyback spring not holding enough tension on hour flyback lever.

5. At this point, put dial and hands on chronograph and recase; do not put on back of case. Place the chronograph in front of you, pendant up with train side facing you. Push date setting button at bottom of case and check the following:

A. Check to see that date hand moves one space on date dial each time button is pushed.

CORRECTION: The following errors could prevent the date hand moving one space each time button is pushed:

1. Date hand loose on date wheel post.
2. Date hand not set correctly.

6. Push button at left of pendant, hold in this position, and check the following:

A. Check to see that seconds wheel and minute register wheel return the hands connected to these wheels to a zero position.

(Continued on next page)

FUNCTIONAL RESULTS
(Continued)

CORRECTION: The following errors could prevent these hands from returning to a zero position:

1. Loose hands or hands not being set correctly.
 2. The second or minute register wheel binding and not pivoting freely.
- B. Check to see that the end of minute register pawl lies directly between two teeth on minute register wheel when this wheel is at a zero position.

CORRECTION: The pawl being bent will cause the pawl not to set directly between two teeth on minute register wheel.

Failure to have this pawl properly adjusted will result in minute register wheel moving after flyback lever moves away from heart on this wheel.

7. Release button and check the following:

- A. Check to see that flyback lever returns to its original position.

CORRECTION: The following errors could prevent the flyback lever from returning to its original position:

1. Flyback lever binding and not pivoting freely on post.
2. Flyback lever spring not holding enough tension on flyback lever.

8. Push button at right of pendant, release it, and check the following:

- A. Check depthing of seconds wheel teeth with intermediary wheel teeth.

CORRECTION: The following errors could prevent the correct depthing of these wheels:

1. The chronograph pivoted detent binding and not pivoting freely.

(Continued on next page)

FUNCTIONAL RESULTS
(Continued)

2. Chronograph pivoted detent spring not holding enough tension on chronograph pivoted detent.
3. Improper adjustment of eccentric studs. (See adjustment of eccentric studs.)

B. Check depthing of intermittent wheel teeth with seconds wheel dart tooth.

CORRECTION: The following errors could prevent proper depthing of seconds wheel dart tooth with intermittent wheel teeth:

1. Intermittent lever binding and not turning freely.
2. Improperly adjusted eccentric stud could prevent proper depthing of dart tooth with intermittent wheel teeth. (See adjustment of eccentric studs.)

REMARKS:

If the depthing between seconds wheel dart tooth and intermittent wheel teeth is deep, the minute register wheel may move two teeth each time the seconds wheel makes one revolution. If the depthing is shallow, it may cause the minute register wheel not to move a full tooth and thus will not register the minutes on the dial.

C. Check to see that the sweep second hand moves forward in a steady manner with no irregular jumping or jerking.

CORRECTION: The irregular movement of seconds hand is usually caused by the seconds wheel tension spring not holding a strong enough tension on seconds wheel.

9. Push button at right of pendant a second time, release it, and check the following:

A. Check to see that brake lever is in contact with seconds wheel.

CORRECTION: The following errors could prevent brake lever from contacting seconds wheel:

1. Brake lever binding and not pivoting freely.
2. Brake lever spring not holding enough tension on brake lever.

TACHOMETER

- A. The tachometer is used to indicate the speed of an object in miles per hour. A tachometer can only indicate the average speed of an object travelling over a course of a measured mile.

METHOD OF USING TACHOMETER

1. Start chronograph sweep second hand at the exact moment the object starts to travel the measured distance of one mile.
2. When the object has travelled the course of one mile, stop the chronograph sweep second hand. The point on the tachometer scale where the sweep second hand stopped will indicate the average speed in miles per hour.

SECOND HAND

- B. The second hand indicates the passing of seconds and should move one space each second. One complete revolution of hand denotes passage of one minute. This hand is independent of chronograph mechanism and continues to register the seconds as long as watch is running.

SPLIT SECOND SCALE

- C. This scale is divided into 300 divisions, each indicating $\frac{1}{5}$ of a second. Every fifth division is marked with extra long lines denoting one second.

The main purpose of this scale is to measure a fraction of a second accurately.

DATE HAND

- D. The purpose of the date track is to indicate the date. This is done by the date hand indicating the date on this track. The date hand is automatically controlled by the calendar mechanism and must be corrected manually at the end of each month for those months having less than 31 days.

MINUTE REGISTER

- E. The minute register hand indicates on the dial the number of minutes that have elapsed since the beginning of the registration of the sweep second hand. One complete revolution of the minute register hand indicates the passage of thirty minutes; two revolutions, one hour.

HOURLY REGISTER

- F. The hour register hand indicates on the dial the number of hours that have elapsed since the beginning of the registration of the sweep second hand. Each division on scale denotes one half-hour. Each number on scale denotes one hour. One complete revolution of hour register hand indicates twelve hours have elapsed. This hand will register the hours as long as the chronograph mechanism is in operation.

REPLACING THE HANDS CORRECTLY ON A CHRONOGRAPH

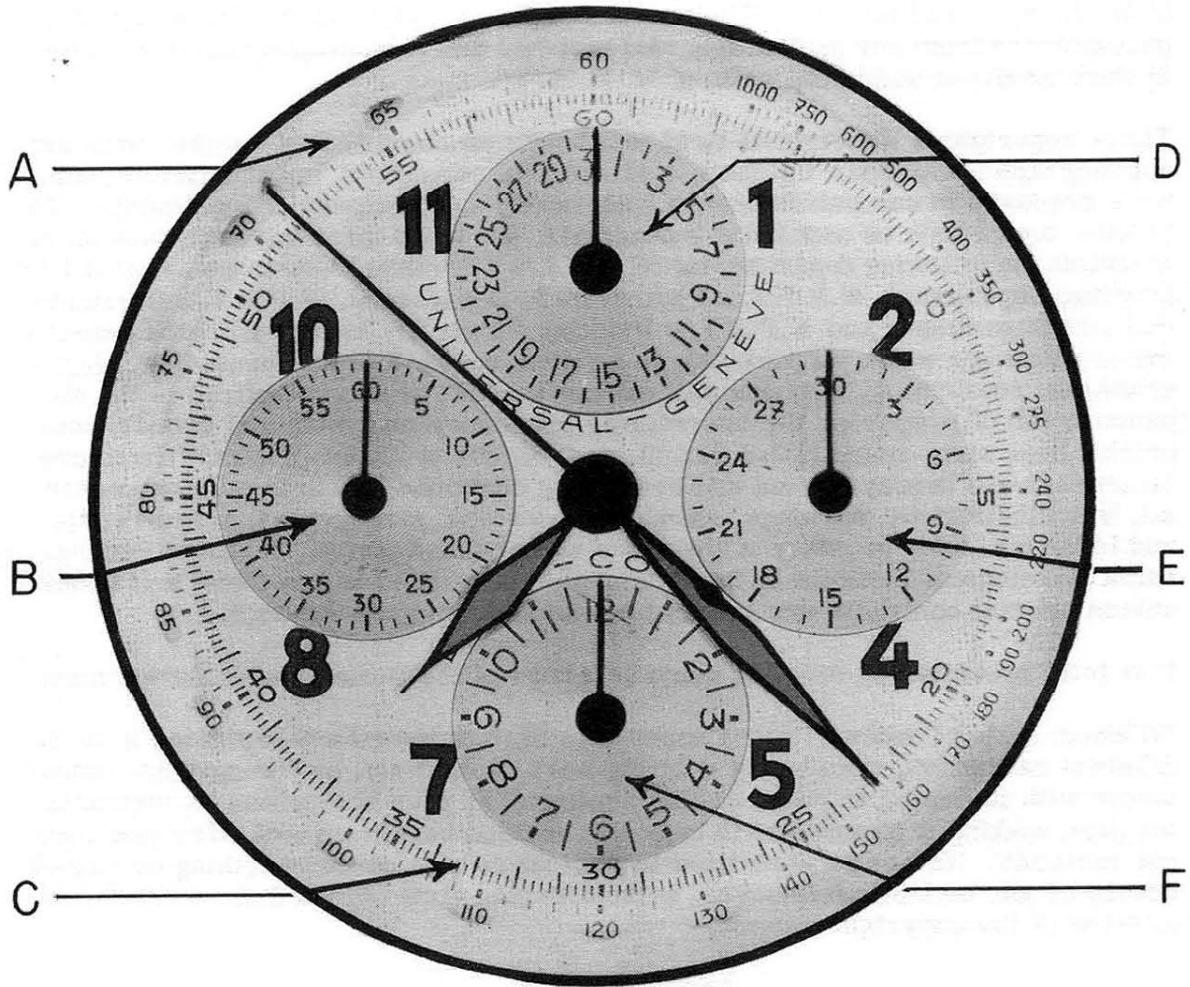

After the chronograph is completely assembled and in working condition, place the chronograph in its case. Now replace the hands as follows: (1) Replace the date hand with hand pointing to 31 on the date scale "B". (2) Pull out winding stem placing chronograph in a setting position. Rotate the winding stem counter-clockwise until the date hand moves one space. At the instant the date hand moves one space, stop turning the winding stem and place the hour hand and minute hand at 12 o'clock on the dial. The hour hand and minute hand are now set for 12 o'clock midnight. When setting the hands for proper time, you must set them keeping in mind that they are now at 12 o'clock midnight. The reason this must be done is so that the date will change at 12 o'clock midnight each day. The second hand is now placed in position on the scale "B", but at this point do not replace the sweep second hand, the minute register hand, or the hour register hand. Now push the button and bring the flyback lever in towards the center of the watch and while holding the flyback lever in this position, place the minute register hand at 30 on the minute register scale "E". Place the hour register hand at 12 on the hour register scale "F", and place the sweep second hand at 60 on the sweep second scale "C". After these hands are replaced, push the button to start the chronograph mechanism with the sweep second hand turning. Let the chronograph mechanism run for at least forty minutes. Now push the button to bring the flyback lever in towards the center of the watch, and check to see that the minute register hand, the hour register hand, and the sweep second hand return to their original position.