

WORLD'S ONLY
FULLY ILLUSTRATED
CHRONOGRAPH WATCH COURSE
VOLUME 22

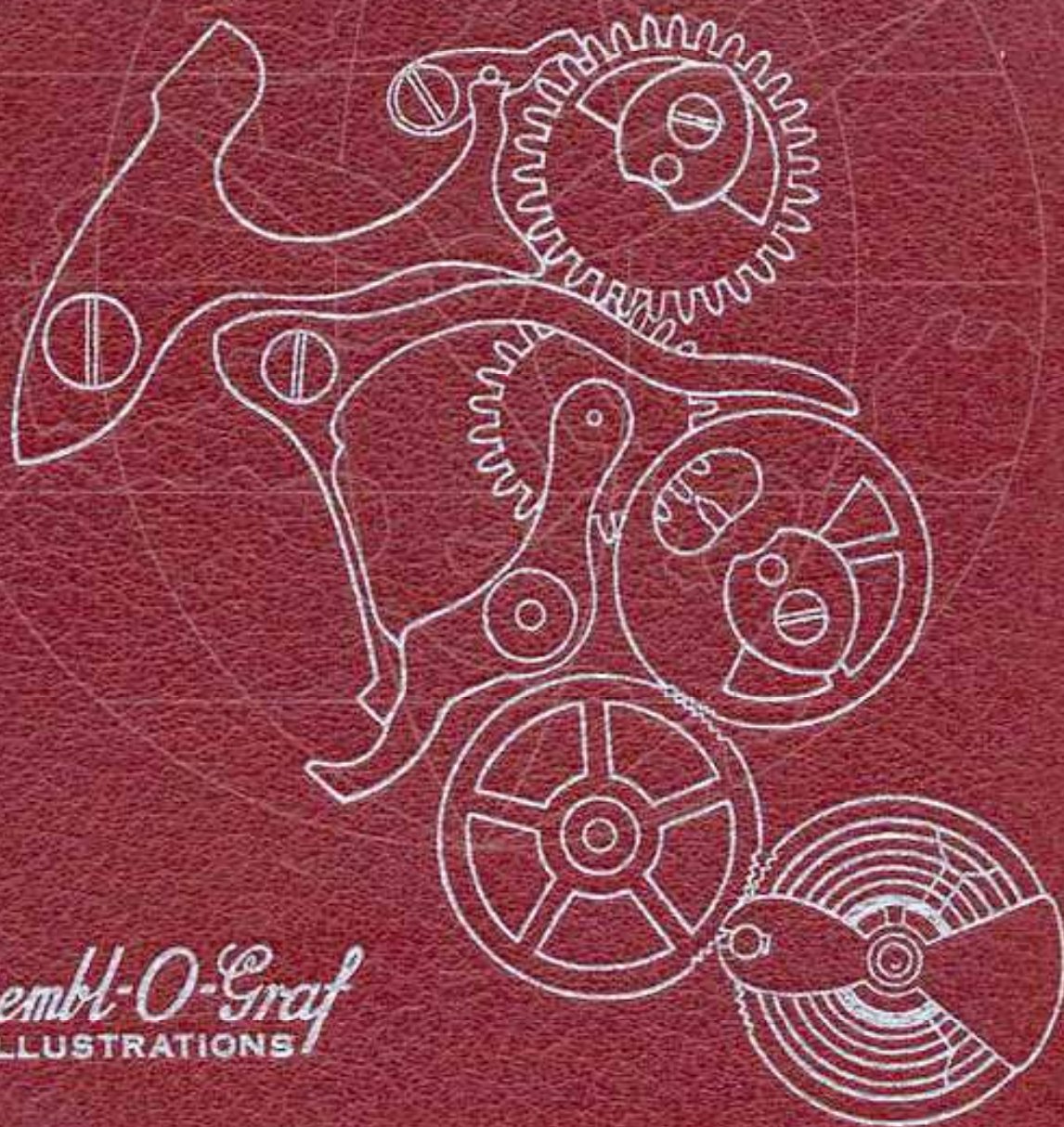

Essembl-O-Graf
ILLUSTRATIONS

IDENTIFICATION OF CHRONOGRAPH

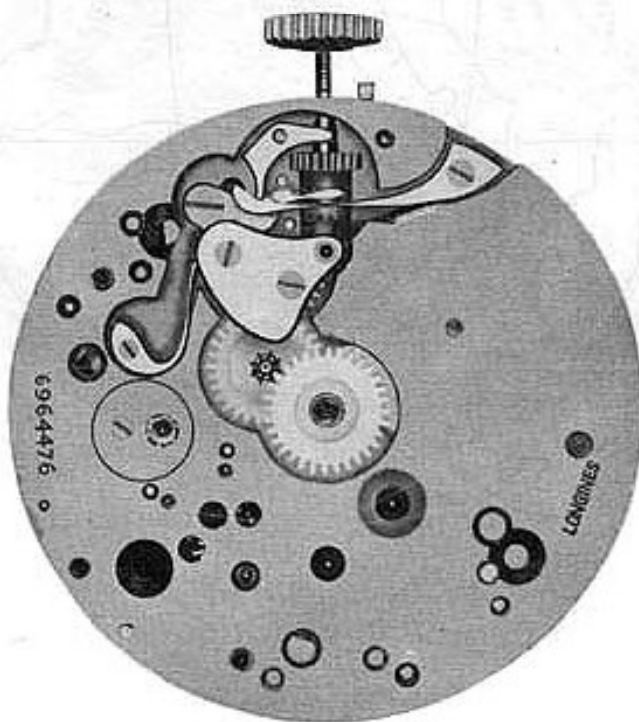

13L

LONGINES



CENTER MINUTE
REGISTER CHRONOGRAPH



ESEMBL-O-GRAF

THE WORLD'S FIRST FULLY
ILLUSTRATED TEXT BOOK
ON
CHRONOGRAPH REPAIRING
AND ADJUSTING

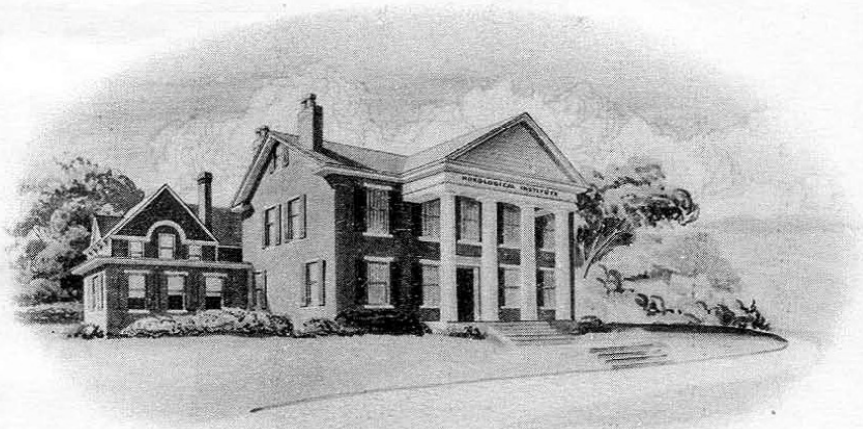

BY
William O. Smith, Sr.
PRESIDENT AND TECHNICAL DIRECTOR
AND
William O. Smith, Jr.
CHIEF ENGINEER, RESEARCH LABORATORIES

WESTERN PENNSYLVANIA HOROLOGICAL INSTITUTE, INC.
PITTSBURGH, PENNSYLVANIA

INSTRUCTIONS
For use of book

DISASSEMBLY OF THE CHRONOGRAPH MECHANISM:

1. Study the isometric drawing at top of page 1-A. The isometric drawing was made for the following purposes:
 - A. It helps to identify the part to be removed.
 - B. This drawing aids in pointing out certain locations on the part that are mentioned in the oiling procedure.
 - C. The text refers to certain points on the part. These points are shown in the isometric drawing. This should aid you in finding the exact location on the part that is described in the text.
 - D. It helps you to know the shape of the part in case a new part has to be made.
2. At the bottom of the page 1-A is a photograph of a chronograph. In this photograph is the same part painted in black. The part is in its exact location that this part occupies in the watch. Find this location in the watch.
3. Read the disassembly procedure and the hazards in disassembly on page 1 in this book.
4. Remove this part in the same procedure as described in the text.
5. A very important item in disassembling a chronograph is keeping the screws in order, much time will be lost in putting the chronograph together if screws are mixed up. This means you have to hunt for each screw, sometimes trying three or four screws before finding the correct one. It cannot be stressed too strongly that care should be taken so that screws are not mixed up. The system that we advise for beginners, is to replace each individual screw after each part is removed. This naturally eliminates the hazard of mixing up the screws and will save you much time in the end. Do this at least until you become so thoroughly familiar with the chronograph that you no longer feel it is necessary.
6. Continue to follow this procedure throughout the book and disassemble each part until the last part of the chronograph is removed.

ASSEMBLY OF THE CHRONOGRAPH MECHANISM:

7. When you are ready to assemble the chronograph mechanism, study the isometric drawing on the last part in this book. This drawing should aid you in identifying the part to be assembled.
8. At the bottom of this page is a photograph of a chronograph. In this photograph is the same part painted in black. The part is in its exact location that this part occupies in the watch.
9. Read the assembly procedure and the hazards in assembling for the last part in this book. (Continued on next page)

INSTRUCTIONS (Continued)

10. Replace the part in its exact location as shown in photograph, using the procedure as described in the text.

11. After you find the correct location for this part in the watch, read the oiling procedure for this part. The oiling procedure for this part is located underneath the isometric drawing. It is best to read the oiling procedure before you put each part in place as there are certain parts that must be oiled immediately as it may prove difficult to oil them later.

12. Replace the screw that holds this part in place. Of course, the screws should be kept in order as we advised above, but if the screws are not in order or the watch was received with screws mixed up, you will find a screw drawn for each part that requires a screw at the bottom of the text page.

13. After replacing this part, replace the next part, etc., until the last part is replaced, which will be part No. 1. Each part should be replaced using the same procedure as described in the text.

(Naturally, the assembly of the chronograph is exactly the reverse of the disassembly.)

14. After disassembling and assembling the chronograph mechanism, start on page 1 and read the function of this part. After reading the function of this part, continue to read the function of each part throughout the book. Study each part, one at a time. This text should help you to understand more fully the purpose of each part in the chronograph mechanism.

15. Now put movement in its case with dial on, then replace hands.

16. Study the text on functional results in this book, and check the chronograph mechanism as described in this text.

NOMENCLATURE OF PARTS FOR CHRONOGRAPH MECHANISM

17. After you have become familiar with the chronograph mechanism, you can disassemble and assemble the chronograph by using the nomenclature of parts as a guide. This makes it possible for you to use a procedure without going through each page in the book.

18. ADJUSTMENT OF ECCENTRIC STUDS:

Read the text on adjustment of eccentric studs, this text should be read in reference to the eccentric stud picture. Now adjust each eccentric stud one at a time in the watch, as described in the text. Use the picture to show you the position of these studs.

19. On each page in this book the part number and the page number are the same. This makes it convenient for the reader and eliminates any confusion.

IDENTIFYING A CHRONOGRAPH OR STOP WATCH

The chronograph and stop watch are very similar in appearance in many respects, but there is a difference which will enable you to distinguish the chronograph from the stop watch.

The chronograph is a watch having at least one supplementary hand in addition to the regular hour, minute, and second hand which can be started, stopped or returned to zero at will. Thus the chronograph can be used as a regular timekeeping watch and may also be used in registering observations.

The stop watch is a watch which has only the necessary hands to register an observation, the hour, minute, and seconds hand being omitted. The stop watch is not used to indicate the time of day, but only to register the length of observations.







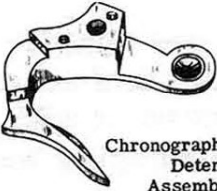
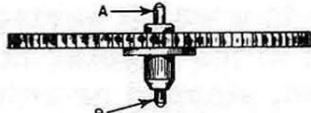
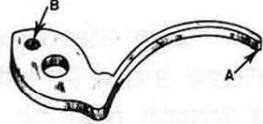
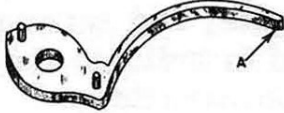
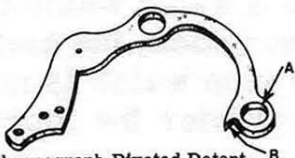
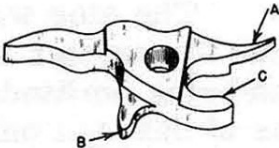
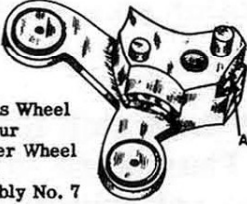
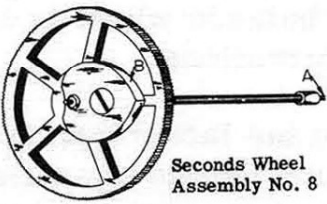

The stop watch is divided into two categories, the stop watch in which the balance wheel is continually in motion and the stop watch in which the balance wheel is in motion only during the actual timing of observations.

The advantage in the latter type is that the watch is running only during the actual timing operation. Thus there is less wear to the stop watch and the mainspring does not have to be wound so often. This is especially true in the stop watch which has a very rapid oscillation of the balance. The stop watch by altering the hairspring and balance wheel to increase the oscillation of the balance can be made to register $1/30$, $1/50$, or even $1/100$ of a second. This increase in the oscillation of the balance in the stop watch is possible because the balance wheel is in motion only during the actual timing operation and the watch does not indicate the time of day.

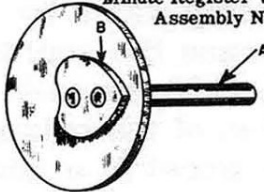
The chronograph is designed to register the time correct to $1/5$ of a second. It would be difficult to make a chronograph register correctly to less than $1/5$ of a second, as the rapid oscillation of the balance would require too large a mainspring to run the watch for a twenty-four hour period, and the hour and minute hand would have to be geared down tremendously to keep the correct time.



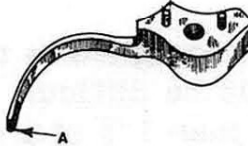
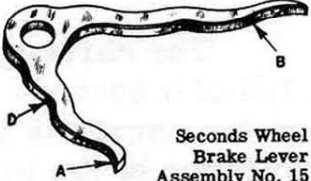

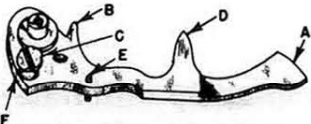
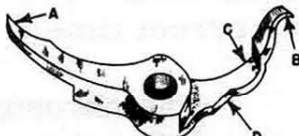

The chronograph usually embodies the basic principles by which the stop watch performs its function, and to anyone familiar with the functions of the various parts of a chronograph should have no trouble understanding stop watch mechanism.

NOMENCLATURE OF PARTS FOR CHRONOGRAPH MECHANISM

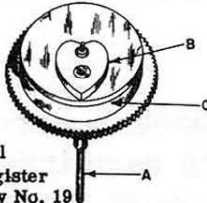
 <p>Chronograph Pivoted Detent Bridge Assembly No. 1</p>	 <p>Intermediary Wheel Assembly No. 2</p>	 <p>Minute Register Brake Lever Spring Assembly No. 3</p>
 <p>Chronograph Pivoted Detent Spring Assembly No. 4</p>	 <p>Chronograph Pivoted Detent Assembly No. 5</p>	 <p>Minute Register Brake Lever Assembly No. 6</p>
 <p>Seconds Wheel and Hour Register Wheel Bridge Assembly No. 7</p>	 <p>Seconds Wheel Assembly No. 8</p>	 <p>Seconds Wheel Tension Spring Assembly No. 9</p>
 <p>Minute Register Wheel Assembly No. 10</p>	 <p>Seconds Wheel and Hour Register Flyback Lever Assembly No. 11</p>	 <p>Seconds Wheel and Hour Register Flyback Lever Spring Assembly No. 12</p>
 <p>Seconds Wheel Brake Lever Spring Assembly No. 13</p>	 <p>Hour Register Brake Lever Spring Assembly No. 14</p>	 <p>Seconds Wheel Brake Lever Assembly No. 15</p>
 <p>Minute Register Flyback Lever Spring Assembly No. 16</p>	 <p>Minute Register Flyback Lever Assembly No. 17</p>	 <p>Hour Register Brake Lever Assembly No. 18</p>

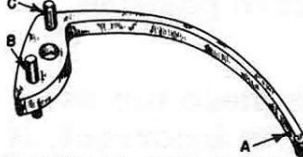
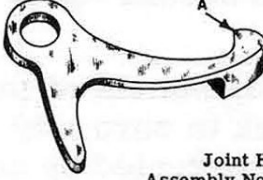
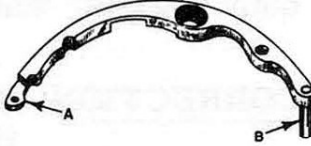
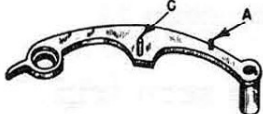
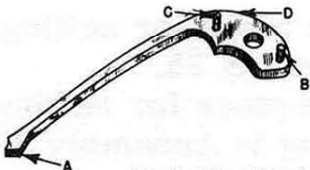
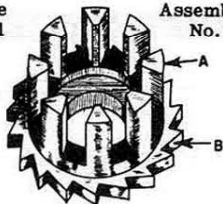
Continued on next page

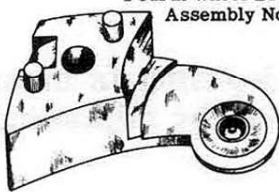
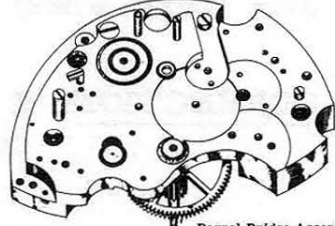
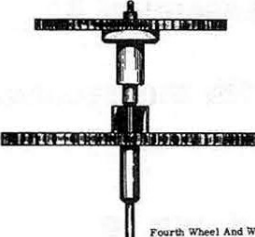
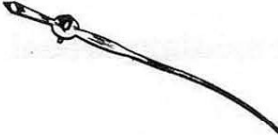
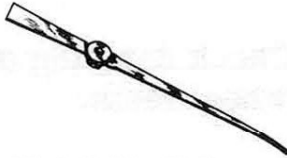
NOMENCLATURE OF PARTS FOR CHRONOGRAPH MECHANISM

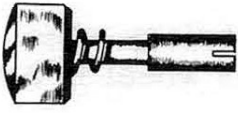
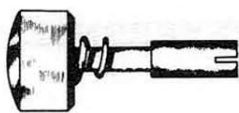
 <p>Wheel Hour Register Assembly No. 19</p>	<p style="text-align: center;">Intermediate Hour Wheel Assembly No. 20</p> 	 <p>Actuating Lever Spring Assembly No. 21</p>
 <p>Push Piece for Setting Back to Zero Spring Assembly No. 22</p>	 <p>Joint Hook Assembly No. 23</p>	 <p>Actuating Lever Assembly No. 24</p>
 <p>Push Piece for Setting Back to Zero Assembly No. 25</p>	 <p>Castle Wheel Pawl Assembly No. 26</p>	<p>Castle Wheel Assembly No. 27</p> 
 <p>Push Piece for Setting Back to Zero Trip Spring Assembly No. 28</p>	<p style="text-align: center;">Fourth Wheel Bridge Assembly No. 29</p> 	 <p style="text-align: right;">Barrel Bridge Assembly Assembly No. 30</p>
 <p style="text-align: center;">Fourth Wheel and Wheel Over Fourth Wheel Assembly No. 31</p>	<p style="text-align: center;">Sweep Second Hand</p> 	<p style="text-align: center;">Minute Register Hand</p> 
 <p>Hour Register Hand</p>	 <p>Chronograph Button</p>	 <p>Chronograph Button</p>

ADJUSTING ECCENTRIC STUDS

THINGS TO CHECK

Listed below are a number of depthings and adjustments controlled by the eccentric studs:

1. Check to see that the push piece for setting back to zero does not drop off the push piece for setting back to zero trip spring until sufficient pressure is applied to push piece to assure the flyback levers returning minute register wheel, hour register wheel and second wheel to a zero position.

CORRECTION: If the adjustment of the push piece for setting back to zero trip spring is incorrect, it can be corrected by adjusting eccentric stud ES-1.

REFERENCE: Push piece for setting back to zero is Assembly 25.
Push piece for setting back to zero trip spring is Assembly 28.

2. Check depthing of intermediary wheel teeth with the wheel over fourth wheel teeth.

CORRECTION: If this depthing is incorrect, it can be corrected by adjusting eccentric stud ES-3.

REFERENCE: Intermediary wheel is Assembly 2.
Wheel over fourth wheel is Assembly 31.

3. Check depthing of intermediary wheel teeth with the seconds wheel teeth.

CORRECTION: If this depthing is incorrect, it can be corrected by adjusting eccentric stud ES-2.

REFERENCE: Intermediary wheel is Assembly 2.
Seconds wheel is Assembly 8.

ADJUSTING ECCENTRIC STUDS

DO NOT REMOVE THESE STUDS

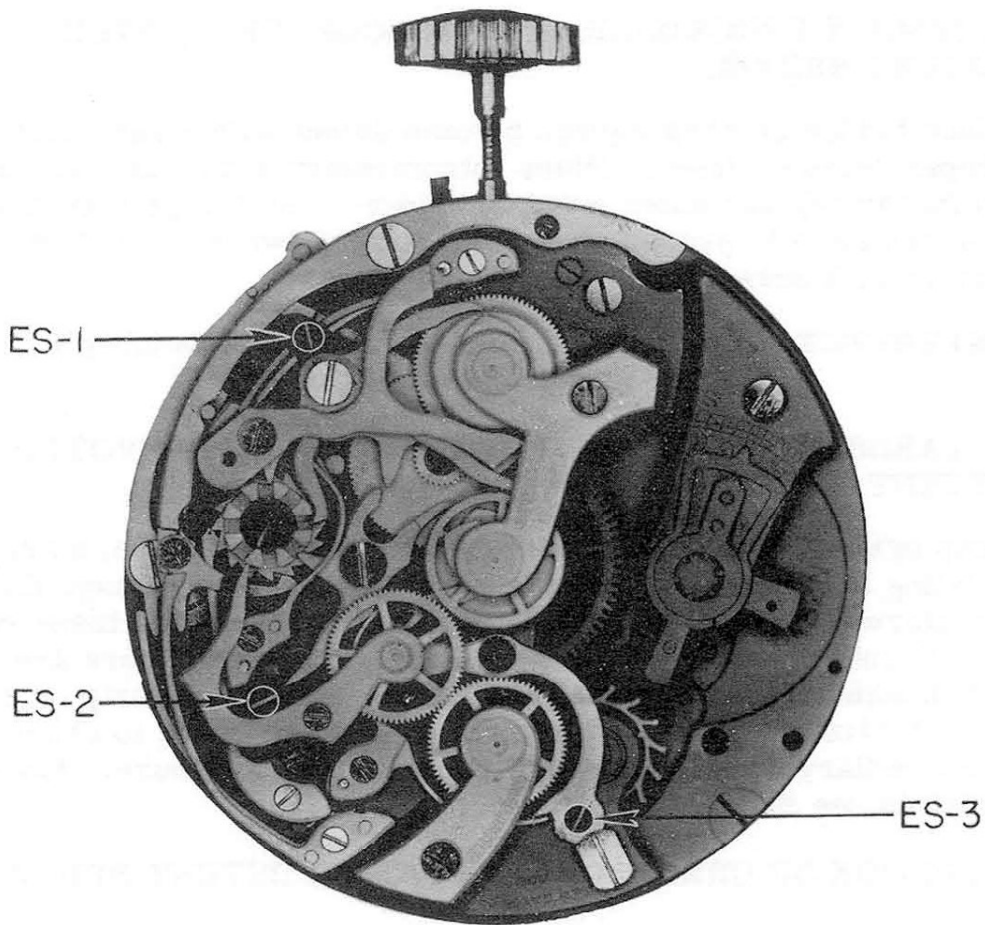

CAUTION

In disassembling or assembling chronograph it is a good policy not to turn eccentric studs. These eccentric studs are used to adjust one part to another and naturally in turning these studs you will lose the desired adjustment of the chronograph mechanism which will cause the chronograph to function incorrectly. Another reason for not turning these studs unless it is necessary is that they soon become loose and will not hold the desired adjustment.

PART NO. 1

A. DISASSEMBLY PROCEDURE OF CHRONOGRAPH PIVOTED DETENT BRIDGE:

This bridge is held in place by beveled countersink screw BS-1. Remove screw and loosen bridge from chronograph pivoted detent by sliding a thin-blade screw-driver under bridge. When steady pins are free, bridge may be lifted out of place.

(The shape of screw for this part is shown at bottom of page.)

B. ASSEMBLY PROCEDURE OF CHRONOGRAPH PIVOTED DETENT BRIDGE:

Place bridge on chronograph pivoted detent with steady pins over proper holes in detent. Place intermediary wheel so that the pivot on this wheel will enter jewel in bridge. The bridge may now be pressed down to proper place with back of tweezers and beveled countersink screw BS-1 replaced in bridge.

REFERENCE: Chronograph pivoted detent is Assembly 5.
Intermediary wheel is Assembly 2.

C. HAZARDS IN DISASSEMBLY OF CHRONOGRAPH PIVOTED DETENT BRIDGE:

Keep bridge level when pressing down to proper place, as any twisting may crack or chip the jewel in bridge or damage the pivot on intermediary wheel. The bridge and detent where these two parts come together should be checked to see that there are no burrs which would prevent bridge from setting properly on chronograph pivoted detent. At this point, it is advisable to check the intermediary wheel to see that it has proper endshake. Also check to see that it spins freely.

D. FUNCTION OF CHRONOGRAPH PIVOTED DETENT BRIDGE:

The function of this bridge is to hold the intermediary wheel in position so that it can function properly.

REFERENCE: Intermediary wheel is Assembly 2.

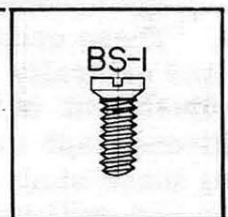

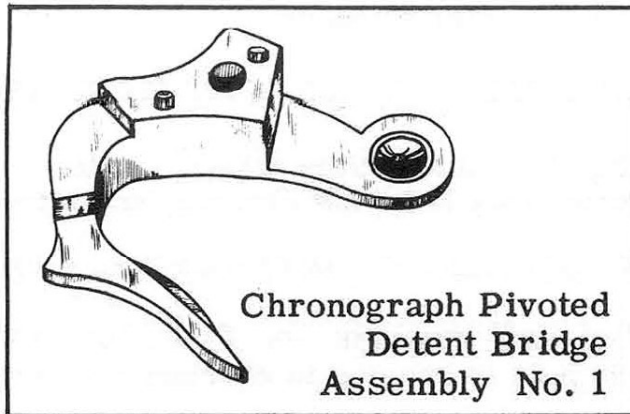

OILING

The pivot in jewel in chronograph pivoted detent bridge should be oiled as you usually oil a train pivot in a watch.

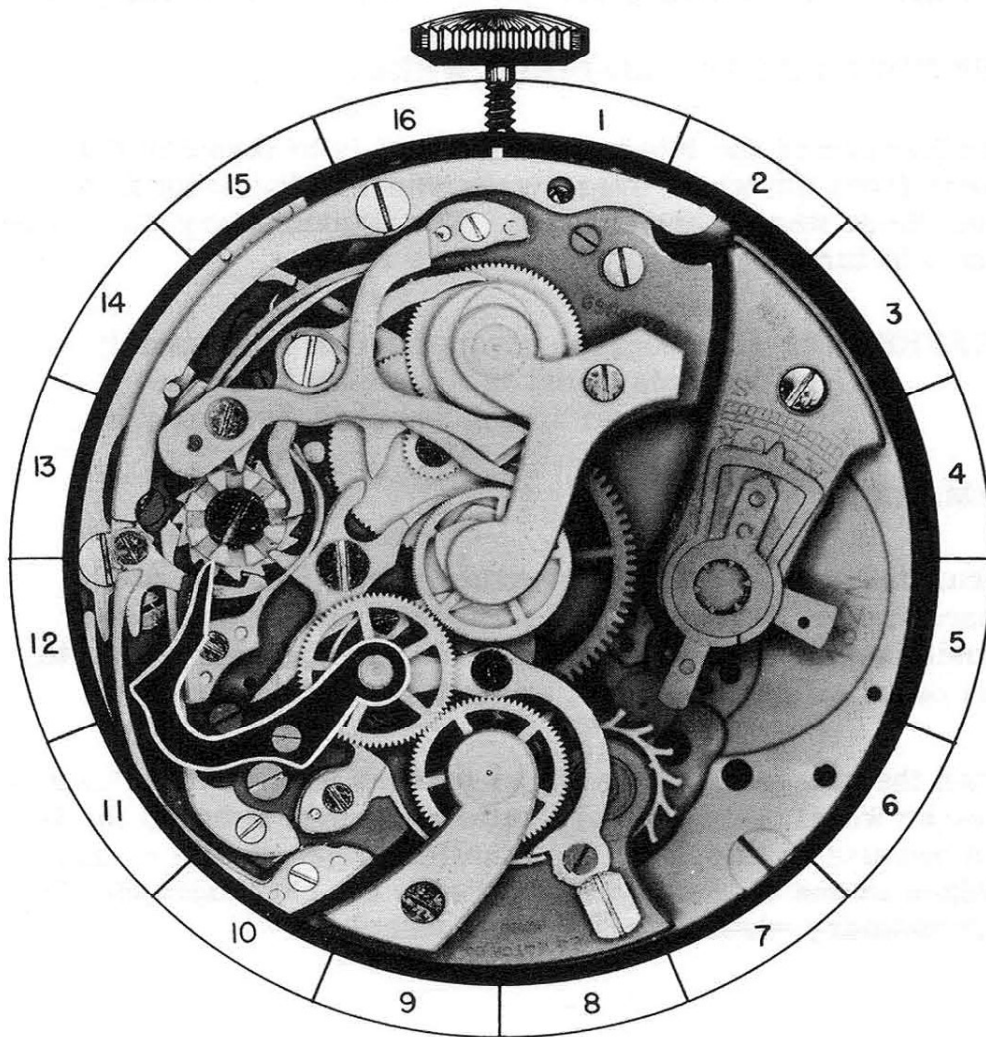

1-A

PART NO. 2

A. DISASSEMBLY PROCEDURE OF INTERMEDIARY WHEEL:

When removing the intermediary wheel, lift the wheel straight up to remove the pivot from the chronograph pivoted detent.

B. ASSEMBLY PROCEDURE OF INTERMEDIARY WHEEL:

The end "A" of staff should be up. Place the bottom pivot "B" of staff in hole in bushing in chronograph pivoted detent.

C. HAZARDS IN ASSEMBLY OF INTERMEDIARY WHEEL:

Pivot hole in bushing in chronograph pivoted detent should be carefully examined before replacing intermediary wheel. Any imperfections here will affect the timekeeping of the watch and hinder the proper operation of the chronograph.

REFERENCE: Chronograph pivoted detent is Assembly 5.

D. FUNCTION OF INTERMEDIARY WHEEL:

The function of the intermediary wheel is to transfer the power from the wheel over fourth wheel to the seconds wheel when these wheels are engaged. The intermediary wheel continues to turn as long as the watch is running.

REFERENCE: Chronograph pivoted detent is Assembly 5.
Seconds wheel is Assembly 8.
Wheel over fourth wheel is Assembly 31.

REMARKS:

A careful and detailed examination should be made of all wheels before replacing in the chronograph. Each wheel should be examined for burred pivots, bent or burred teeth, dirt or small pieces of grit wedged between the teeth.

When the saw teeth of one wheel meshes with the saw teeth of another wheel, there is very little clearance between the teeth, and because of this, even the smallest piece of dirt or grit wedged in one of these teeth may stop the chronograph. The intermediary wheel is a saw tooth wheel.

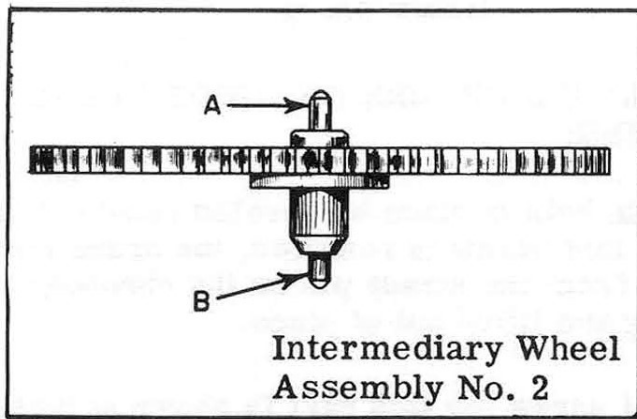

OILING

The bottom pivot on intermediary wheel should be oiled before placing it in the chronograph pivoted detent.

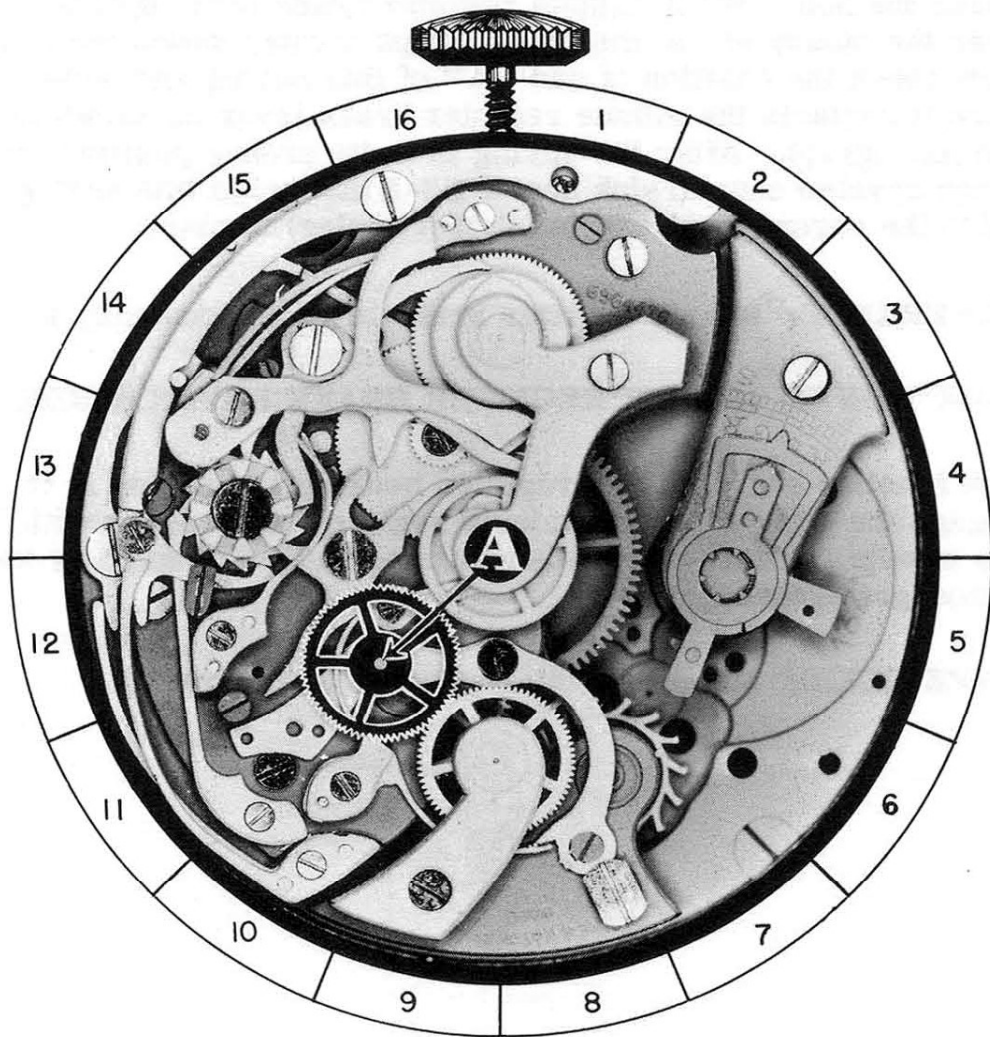

2-A

PART NO. 3

A. DISASSEMBLY PROCEDURE OF MINUTE REGISTER BRAKE LEVER SPRING:

This spring is held in place by beveled countersink screw BS-2. When this screw is removed, the brake lever spring can be lifted from the steady pin on the chronograph pivoted detent spring and lifted out of place.

(The shape of screw for this part is shown at bottom of page.)

REFERENCE: Chronograph pivoted detent spring is Assembly 4.

B. ASSEMBLY PROCEDURE OF MINUTE REGISTER BRAKE LEVER SPRING:

Place the hole "B" in minute register brake lever spring over the steady pin on the chronograph pivoted detent spring. Now check the position of end "A" of this spring and make sure it contacts the minute register brake lever as shown in the photograph. After the spring is in its proper position, replace beveled countersink screw BS-2 that holds this spring (also the chronograph pivoted detent spring) in place.

REFERENCE: Minute register brake lever is Assembly 6.

C. FUNCTION OF MINUTE REGISTER BRAKE LEVER SPRING:

The function of the minute register brake lever spring is to engage the end "A" of the minute register brake lever with the minute register wheel when it is permitted to do so by the chronograph mechanism.

REFERENCE: Minute register wheel is Assembly 10.

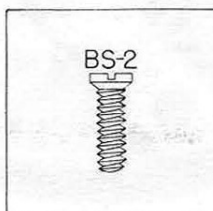

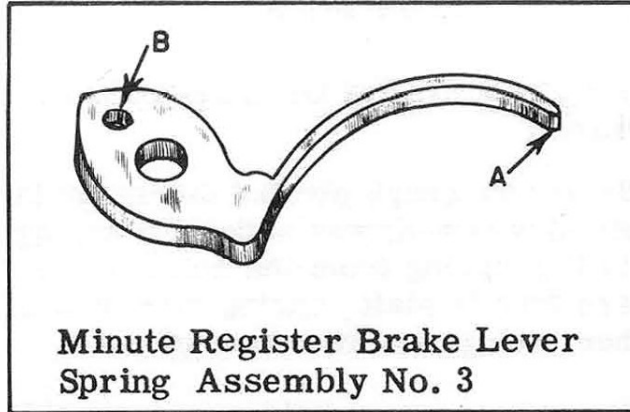

OILING

End "A" of minute register brake lever spring should be slightly moistened with oil at point of contact with minute register brake lever.

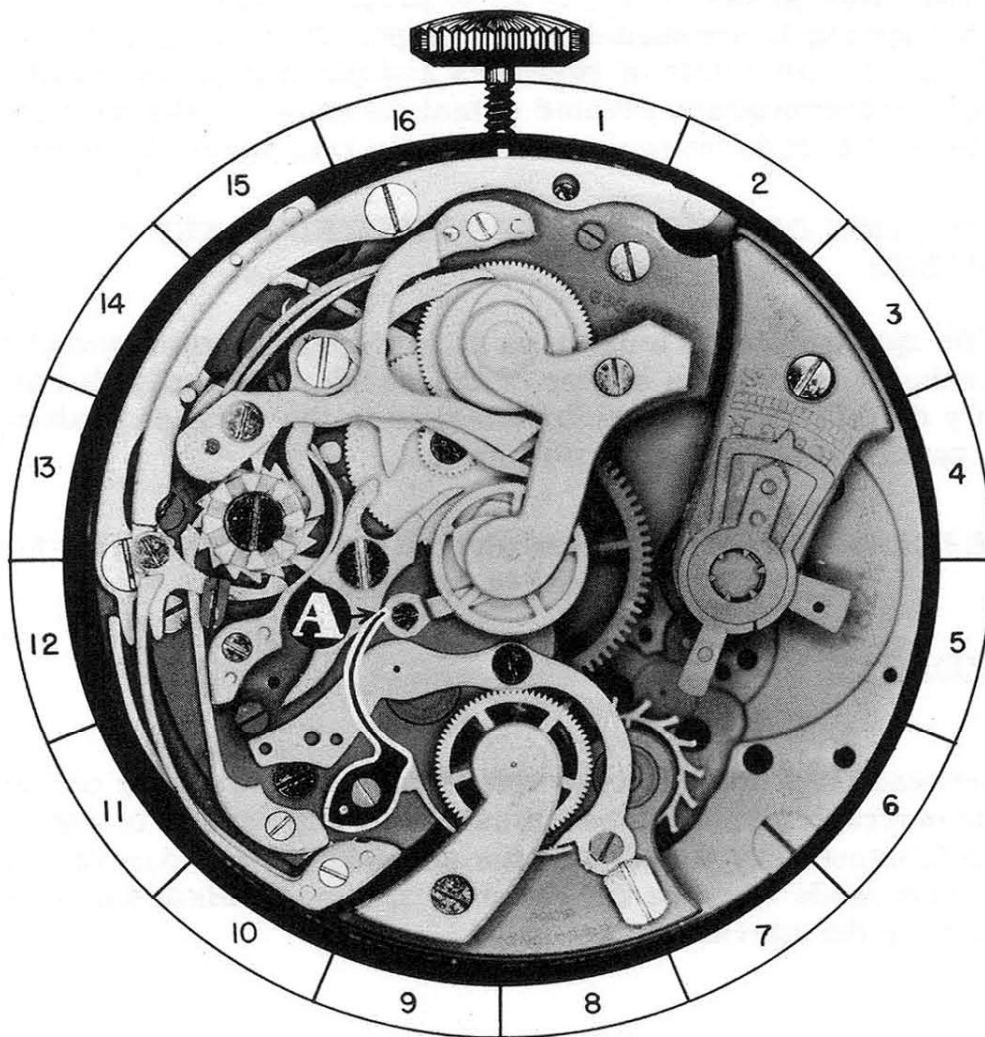

PART NO. 4

A. DISASSEMBLY PROCEDURE OF CHRONOGRAPH PIVOTED DETENT SPRING:

To remove the chronograph pivoted detent spring, slide a finely-sharpened screw-driver under the spring loosening the steady pins in this spring from the holes in plate. When steady pins are free in plate, spring may be slid from beneath the fourth wheel bridge and lifted out of place.

REFERENCE: Fourth wheel bridge is Assembly 29.

B. ASSEMBLY PROCEDURE OF CHRONOGRAPH PIVOTED DETENT SPRING:

Place the chronograph pivoted detent spring in its proper position under the fourth wheel bridge as shown in the photograph with the steady pins on this spring entering the proper holes. Now press spring down to proper place. At this point, after spring is pressed down to proper place, grip end "A" of spring with a pair of tweezers and place it on the notch "B" of chronograph pivoted detent as shown in the photograph. The next part to be replaced will hold this spring in place.

C. FUNCTION OF CHRONOGRAPH PIVOTED DETENT SPRING:

This spring holds a tension on chronograph pivoted detent forcing it toward the center of the watch. Naturally, it can only do this when the castle wheel is in the correct position to permit it to perform this function.

REFERENCE: Chronograph pivoted detent is Assembly 5.
Castle wheel is Assembly 27.

REMARKS:

The tension of the chronograph pivoted detent spring on the chronograph pivoted detent must be strong enough to engage the intermediary wheel with the seconds wheel. Any excess tension tends to make the chronograph mechanism harder to work by the operator.

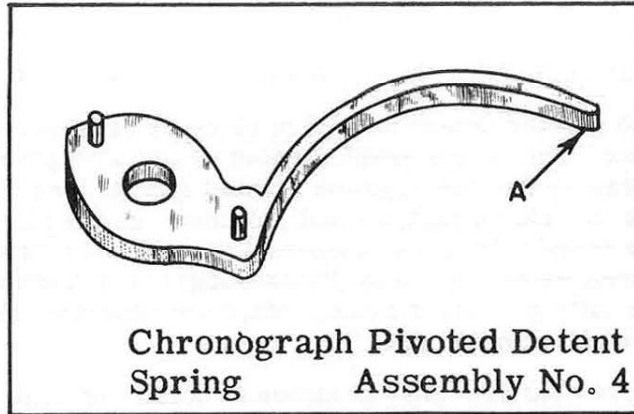

OILING

End "A" of chronograph pivoted detent spring should be slightly moistened with oil at point of contact with chronograph pivoted detent.



4-A

PART NO. 5

A. DISASSEMBLY PROCEDURE OF CHRONOGRAPH PIVOTED DETENT:

The chronograph pivoted detent is held in place by shouldered screw SS-1 and a plate screw. The chronograph pivoted detent also pivots on an eccentric stud. To remove the chronograph pivoted detent, turn the plate screw "D" as shown in the photograph so that the chronograph pivoted detent will clear this screw when it is being removed from the eccentric stud. Now remove shouldered screw SS-1 and lift chronograph pivoted detent from the stud on the plate lifting it out of place. After chronograph pivoted detent is removed, tighten plate screw "D"

(The shape of screw for this part is shown at bottom of page.)

B. ASSEMBLY PROCEDURE OF CHRONOGRAPH PIVOTED DETENT:

Make sure plate screw "D" is in its proper position so that the hole "A" in chronograph pivoted detent can be placed over the eccentric stud. Place the hole over the eccentric stud and tighten plate screw "D" preventing chronograph pivoted detent from being lifted out of place. Now replace shouldered screw SS-1 that holds the chronograph pivoted detent in place. After chronograph pivoted detent is replaced, check to see that it pivots freely under the head of shouldered screw SS-1 and on the eccentric stud.

C. FUNCTION OF CHRONOGRAPH PIVOTED DETENT:

The function of the chronograph pivoted detent is to engage and disengage the intermediary wheel with the seconds wheel.

REFERENCE: Intermediary wheel is Assembly 2.
Seconds wheel is Assembly 8.

REMARKS:

When the chronograph mechanism is disengaged, the intermediary wheel should be separated from the seconds wheel only the distance necessary to be sure that these wheels will not touch at any time. Any excess separation of these two wheels will increase the "Movement of Translation" as the intermittent wheel moves to engage with the seconds wheel.

For example: If the wheel over fourth wheel is held stationary and the intermediary wheel is moved to engage with seconds wheel, the intermediary wheel must turn on its axis. This turning of the intermediary wheel on its axis is known as the "Movement of Translation".

When the "Movement of Translation" is excessive, it may cause the seconds hand to jump forward at the instant chronograph is engaged.

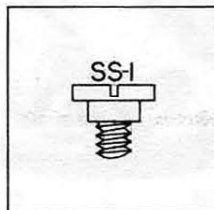

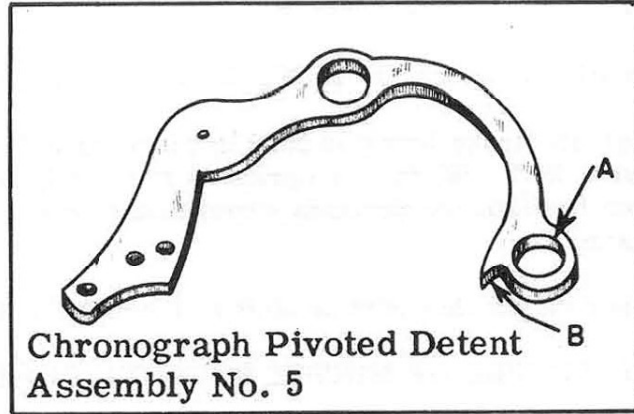

OILING

The eccentric stud on which the chronograph pivoted detent pivots should be slightly moistened with oil.

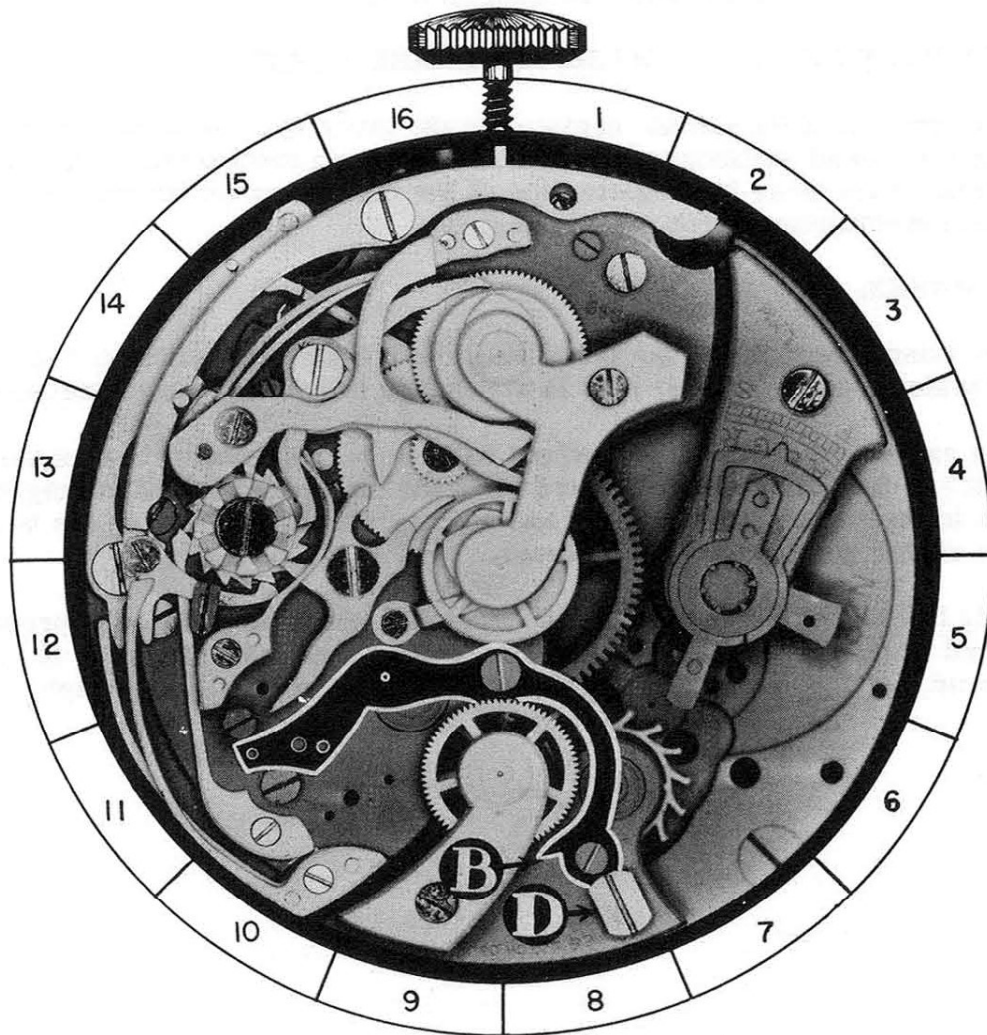

5-A

PART NO. 6

A. DISASSEMBLY PROCEDURE OF MINUTE REGISTER BRAKE LEVER:

The minute register brake lever is held in place by left-threaded shouldered screw SS-2. When this screw is removed, the brake lever can be slid from beneath the seconds wheel brake lever spring and lifted out of place.

(The shape of screw for this part is shown at bottom of page.)

B. ASSEMBLY PROCEDURE OF MINUTE REGISTER BRAKE LEVER:

Place the minute register brake lever in its proper position with the end "B" of minute register brake lever in contact with the columns of the castle wheel. End "B" of minute register brake lever must fit under seconds wheel brake lever spring. When the minute register brake lever is in its proper position, replace left-threaded shouldered screw SS-2 that holds this brake lever in place.

REFERENCE: Seconds wheel brake lever spring is Assembly 13.
Castle wheel is Assembly 27.

C. FUNCTION OF MINUTE REGISTER BRAKE LEVER:

The function of the minute register brake lever is to hold the minute register wheel stationary when the chronograph mechanism is disengaged. This stops the registration of the minutes when the chronograph mechanism is not registering.

REMARKS:

The minute register brake lever should not hold any greater pressure on minute register wheel than is necessary to hold the wheel stationary.

Any excess pressure on this wheel will cause the center wheel of the watch to turn unnecessarily hard when the chronograph is disengaged, due to the increased friction of minute register wheel post on the hollow center post of the center wheel.

This friction being applied to the center wheel of the watch will probably not greatly affect the timekeeping of the watch; nevertheless, it should be taken into consideration when adjusting the chronograph.

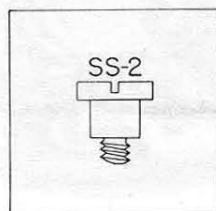

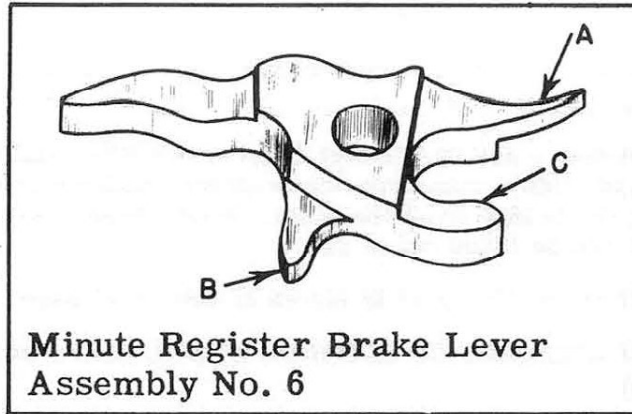

OILING

These points on minute register brake lever should be slightly moistened with oil:

1. Shoulder of screw on which brake lever pivots.
2. Surface "C" that contacts surface "D" on minute register flyback lever.

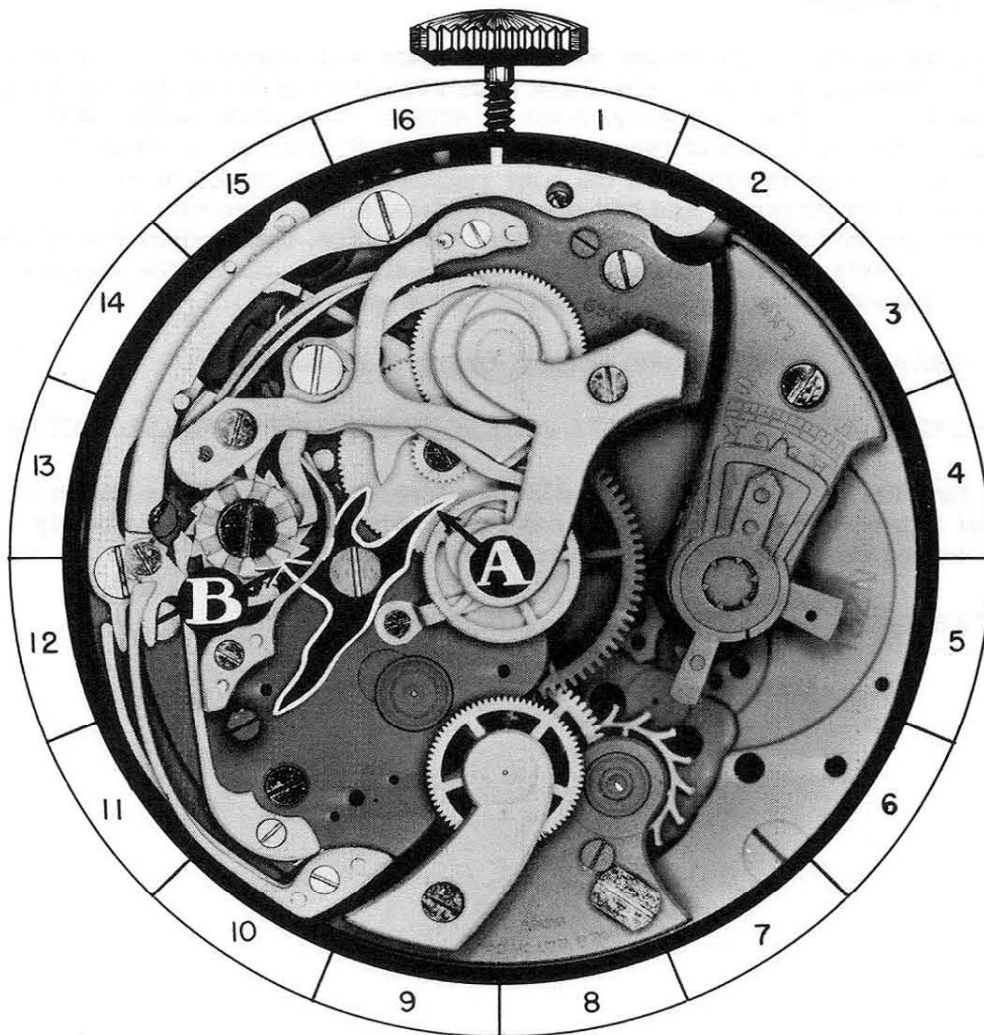

6-A

PART NO. 7

A. DISASSEMBLY PROCEDURE OF SECONDS WHEEL AND HOUR REGISTER WHEEL BRIDGE:

This bridge is held in place by fillister head screw FS-1 and steady pins. Remove screw and slide a thin-blad screw-driver under notch "A" in bridge loosening the bridge from the plate. When steady pins are free in the plate, the bridge can be lifted out of place.

(The shape of screw for this part is shown at bottom of page.)

B. HAZARDS IN DISASSEMBLY OF SECONDS WHEEL AND HOUR REGISTER WHEEL BRIDGE:

When loosening bridge from plate, be sure to keep bridge level, as any twisting of bridge may burr the pivots on seconds wheel or hour register wheel, or may chip the jewels in bridge. Also be careful not to mar the plate or bridge with screw-driver when loosening bridge from plate.

REFERENCE: Seconds wheel is Assembly 8.
Hour register wheel is Assembly 19.

C. ASSEMBLY PROCEDURE OF SECONDS WHEEL AND HOUR REGISTER WHEEL BRIDGE:

Place the bridge in the proper position on plate with steady pins over proper holes. Now place seconds wheel and hour register wheels so that the pivots on these wheels enter the jewel holes in bridge. Now press bridge down to proper place with back of tweezers and replace fillister head screw FS-1. After this bridge is replaced, the hour register wheel should be checked to see that it pivots freely and has proper endshake. The seconds wheel should also be checked for freedom, etc. Of course, the seconds wheel will not spin freely unless the tension on this wheel is released. The seconds wheel tension spring holds a tension on this wheel.

REFERENCE: Seconds wheel tension spring is Assembly 9.

D. FUNCTION OF SECONDS WHEEL AND HOUR REGISTER WHEEL BRIDGE:

The function of this bridge is to hold the seconds wheel and hour register wheel in position so these wheels can function properly. Also indirectly, this bridge holds the minute register wheel in position.

REFERENCE: Seconds wheel is Assembly 8.
Hour register wheel is Assembly 19.
Minute register wheel is Assembly 10.

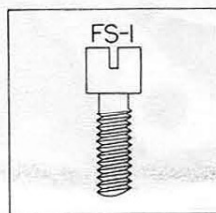

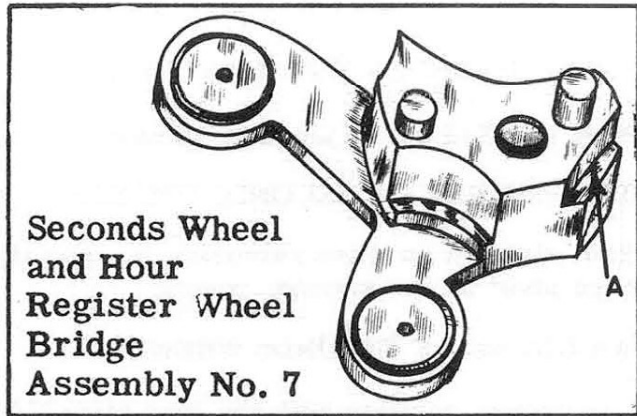

OILING

The pivots in the jewels in this bridge should be oiled as you usually oil the train pivots in a watch.

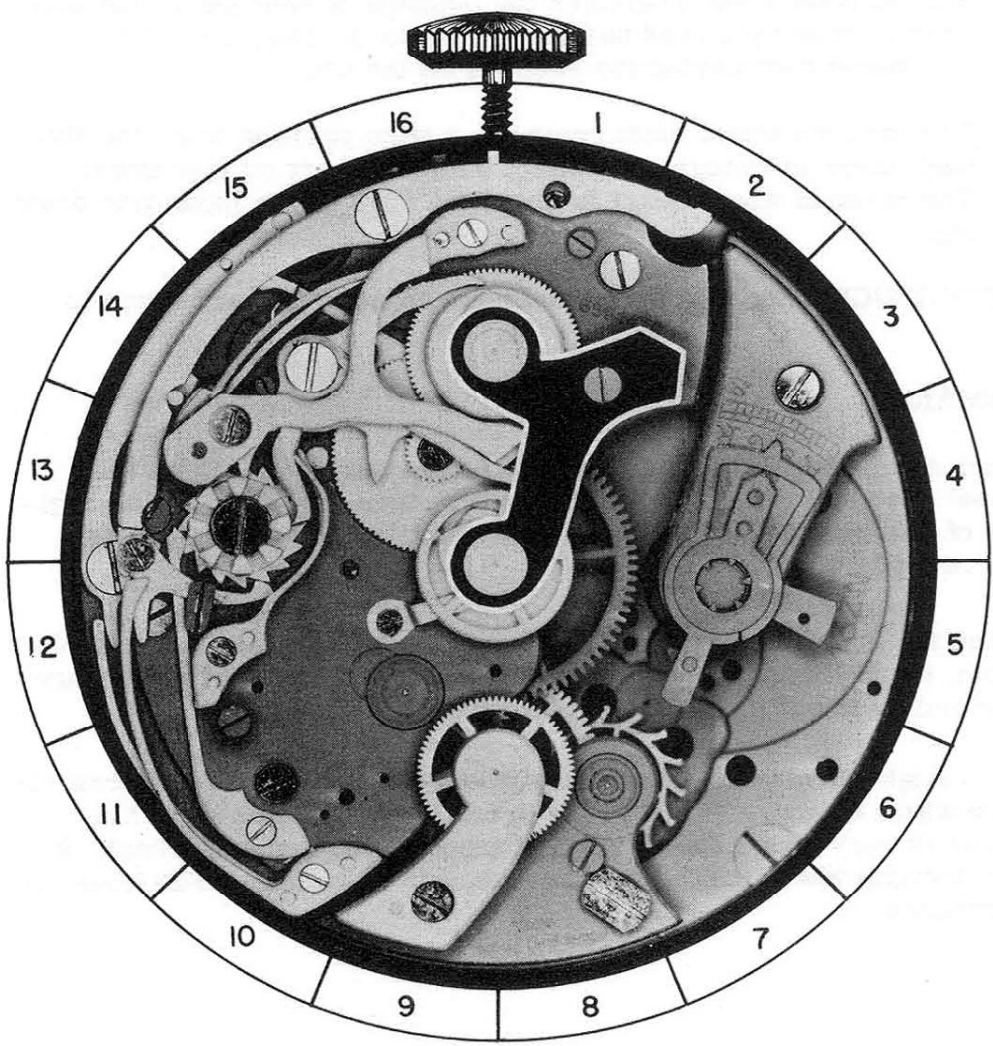

7-A

PART NO. 8

A. DISASSEMBLY PROCEDURE OF SECONDS WHEEL:

The seconds wheel is lifted out of place to remove it.

B. HAZARDS IN DISASSEMBLY OF SECONDS WHEEL:

Lift seconds wheel straight up when removing it. Any tilting of wheel may damage pivot on the seconds wheel.

C. ASSEMBLY PROCEDURE OF SECONDS WHEEL:

Place wheel in its proper position with the long pivot "A" down in hollow minute register wheel staff.

REFERENCE: Minute register wheel is Assembly 10.

D. FUNCTION OF SECONDS WHEEL:

The function of the seconds wheel is to do two things:

1. The seconds wheel registers the passage of seconds on the dial. This is done by a hand being attached to the long pivot "A" on this wheel registering the seconds on the dial.
2. The seconds wheel must return to a zero position when the flyback lever is brought in contact with the heart on this wheel. The seconds wheel heart is shown as "B" in the isometric drawing.

REFERENCE: Seconds wheel and hour register flyback lever is Assembly 11.

REMARKS:

When examining the seconds wheel, notice that the teeth on this wheel are very fine. These fine teeth reduce the error in the register of seconds at the instant the intermediary wheel engages with the seconds wheel.

When the intermediary wheel teeth engage with the seconds wheel teeth, more times than not, the intermediary wheel will not engage perfectly without the seconds wheel turning slightly.

This slight turning of the seconds wheel at the instant the intermediary wheel engages with it is the error I am speaking of. This error is very small due to the fine teeth on the seconds wheel. If the seconds wheel teeth were increased in size, this error would be increased.

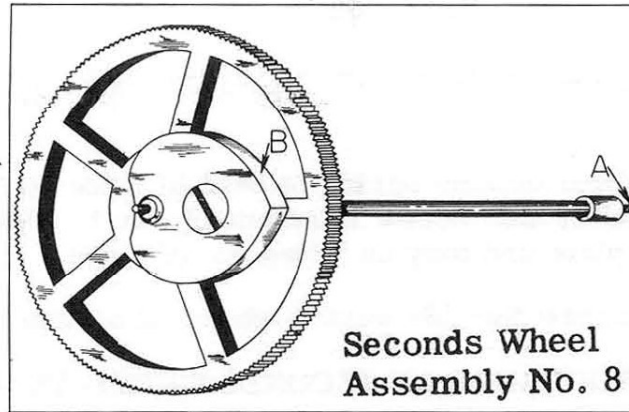

Seconds Wheel
Assembly No. 8

OILING

The top pivot on seconds wheel should be oiled after bridge for this part is replaced.

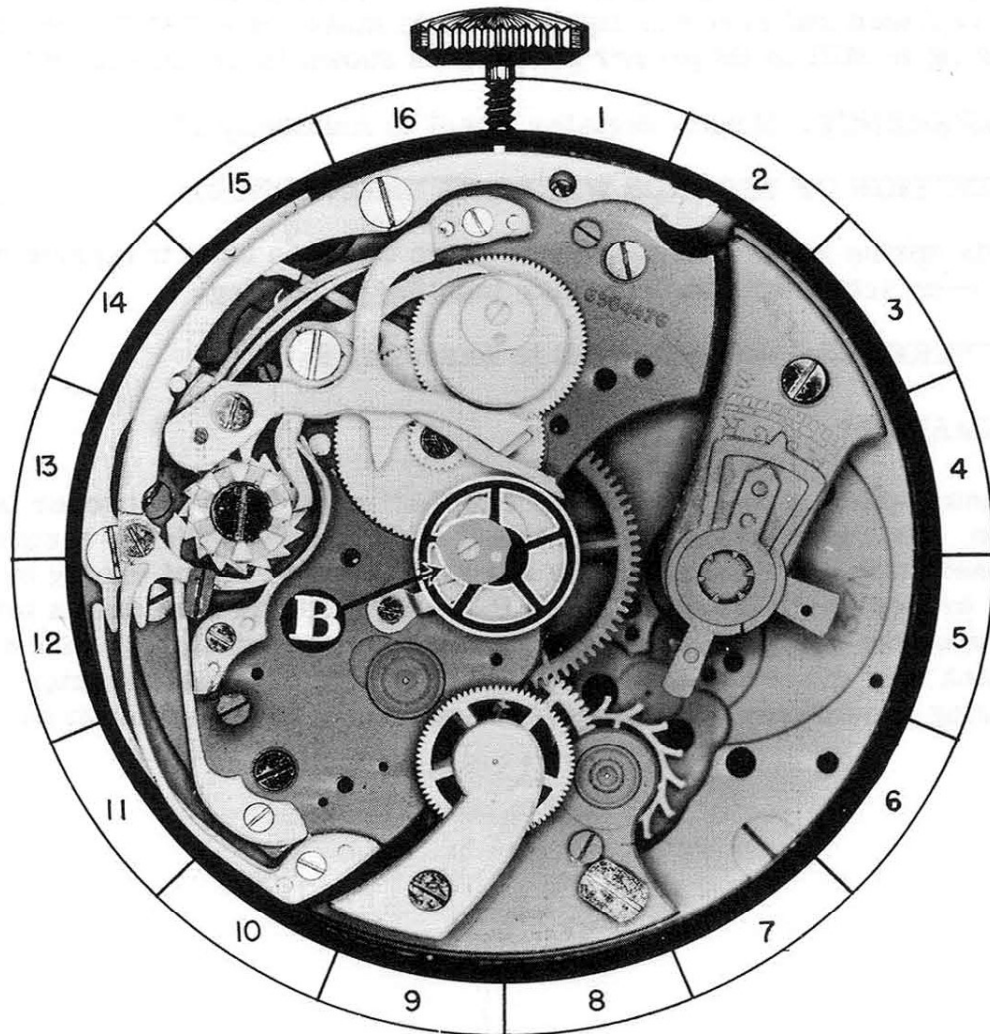

8-A

PART NO. 9

A. DISASSEMBLY PROCEDURE OF SECONDS WHEEL TENSION SPRING:

The seconds wheel tension spring is held in place by fillister head screw FS-2. After this screw is removed, the tension spring will be free on the plate and may be lifted out of place.

(The shape of screw for this part is shown at bottom of page.)

B. ASSEMBLY PROCEDURE OF SECONDS WHEEL TENSION SPRING:

Place the seconds wheel tension spring in its proper position with hole in spring over proper hole in plate. Replace fillister head screw FS-2, but before tightening screw, make sure that end "A" of spring is not over center hole in minute register wheel. End "A" of this spring should fit right along side the hole in the minute register wheel long staff. It should not fit over it. The proper position of this spring is shown in the photograph. After spring is replaced and screw is tight, check to make sure that the tension spring is still in its proper position as shown in the photograph.

REFERENCE: Minute register wheel is Assembly 10.

C. FUNCTION OF SECONDS WHEEL TENSION SPRING:

This spring holds a tension on seconds wheel to keep it turning with an even action with no irregular jumping or jerking.

REFERENCE: Seconds wheel is Assembly 8.

REMARKS:

When replacing this spring, the end "A" must be in its proper position. This is to prevent any contact of the spring with the seconds wheel staff. It is important to see that the end "A" of spring is in its proper position. If it is not, this end of spring may hold a tension on the seconds wheel staff causing excess friction on this wheel which may cause the watch to stop. The seconds wheel tension spring should only hold an upward tension on the seconds wheel.

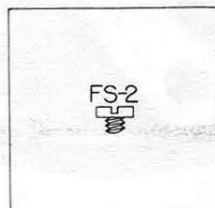

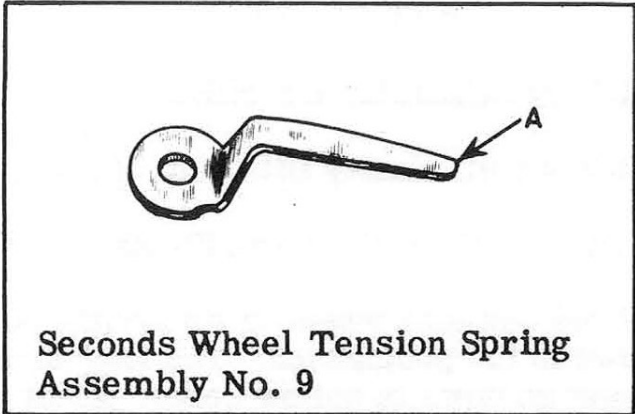

OILING

The seconds wheel tension spring should not be oiled.

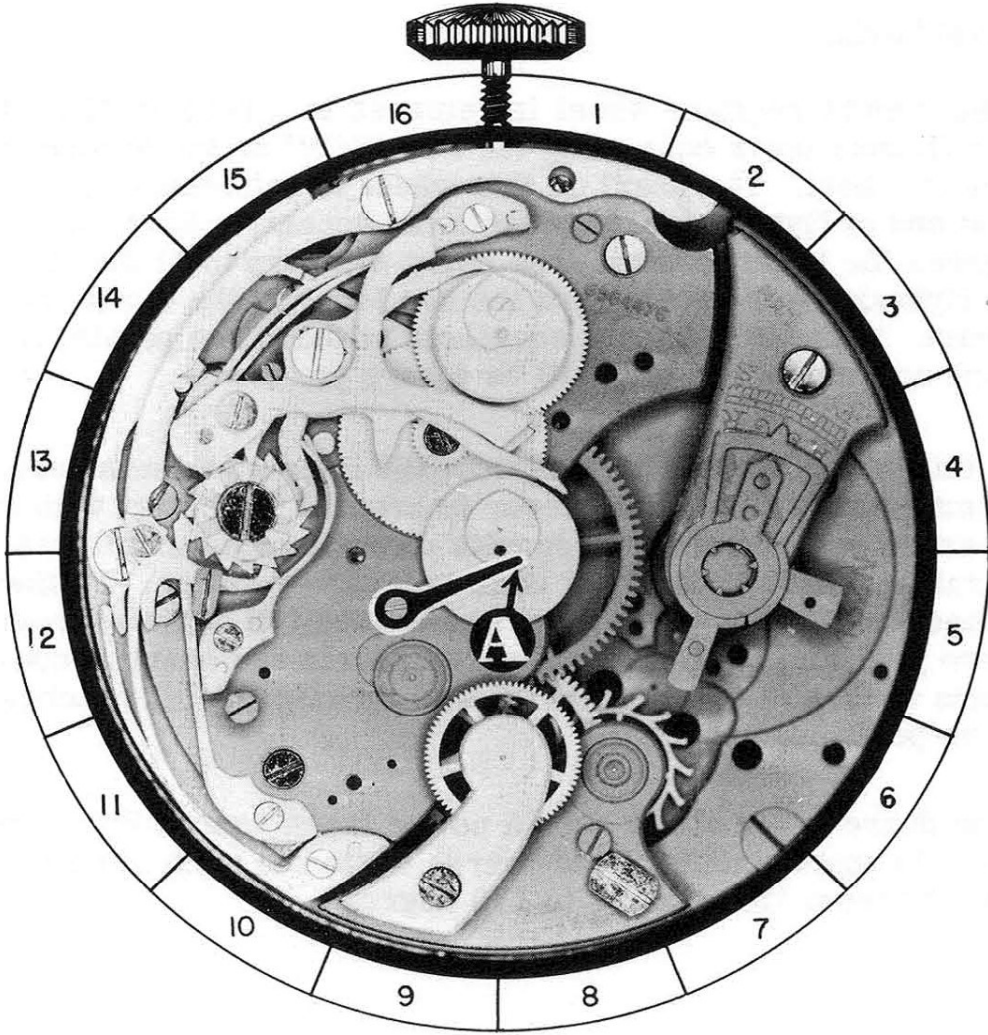

9-A

PART NO. 10

A. DISASSEMBLY PROCEDURE OF MINUTE REGISTER WHEEL:

To remove this wheel, simply lift it out of place.

B. ASSEMBLY PROCEDURE OF MINUTE REGISTER WHEEL:

Place the minute register wheel in its proper position in the watch as shown in the photograph. The long staff "A" on this wheel must go down in hollow center wheel pinion.

C. FUNCTION OF MINUTE REGISTER WHEEL:

The function of the minute register wheel is to record the minutes since the beginning of the registration of the chronograph sweep second hand. The heart "B" on minute register wheel is used to return the hand to zero.

REMARKS:

The minute register wheel is returned to a zero position by the flyback lever contacting the heart "B" on the minute register wheel. The heart on this wheel is set eccentric. The flat end of flyback lever contacts the eccentric heart and forces the heart to turn. The heart will turn until the flat end of flyback lever sets across the two lobes at the top of the heart. With the pressure equalized at these two points, it will turn no further and this will be a zero position.

If this wheel has turned less than 160 degrees from a zero position when the flyback lever is brought in contact with the heart, it will turn in the opposite direction to which it was turning to bring this wheel back to a zero position. On the other hand, if the wheel is turned passed 160 degrees from a zero position, the flyback lever will force the heart to continue to turn in the direction it was turning until it reaches a zero position.

The degree used above should not be taken as exactly correct, as it is approximate. This degree varies in most chronographs from 150 degrees to 170 degrees.

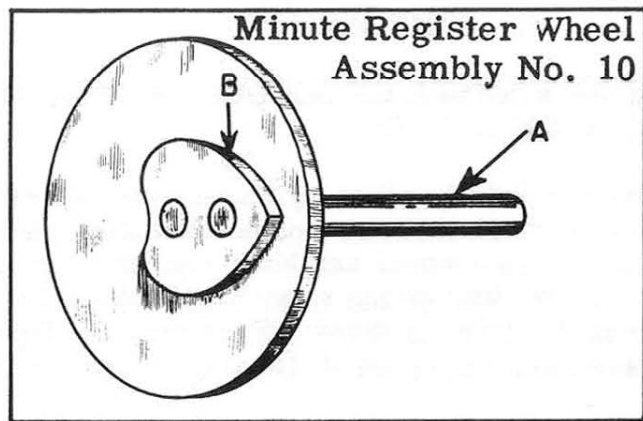

OILING

The minute register wheel should not be oiled.

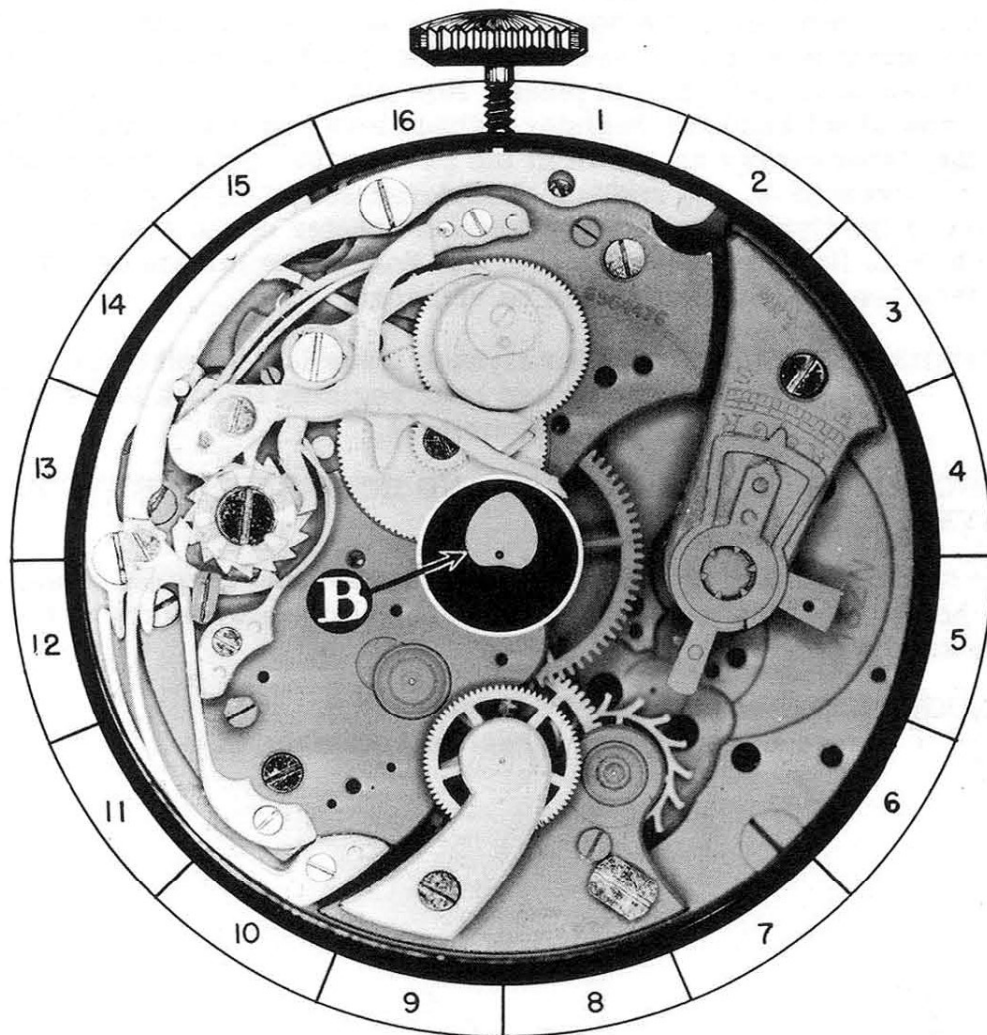

10-A

PART NO. 11

A. DISASSEMBLY PROCEDURE OF SECONDS WHEEL AND HOUR REGISTER FLYBACK LEVER:

The flyback lever is held in place by shouldered screw SS-3 and a post. To remove flyback lever, remove shouldered screw SS-3. Now grip end "A" of seconds wheel and hour register flyback lever spring and force end "A" of this spring away from the center of the watch, unhooking it from the flyback lever. Then grip the flyback lever with a pair of tweezers and lift up on it, freeing it from the post on the plate.

(The shape of screw for this part is shown at bottom of page.)

B. ASSEMBLY PROCEDURE OF SECONDS WHEEL AND HOUR REGISTER FLYBACK LEVER:

Place the seconds wheel and hour register flyback lever in its proper position as shown in the photograph. Hole "A" in flyback lever should be over the same post that the minute register flyback lever pivots on. Now force the seconds wheel and hour register flyback lever spring away from the center of the watch so that the flyback lever can be forced down in place. Now place the end "A" of the seconds wheel and hour register flyback lever spring on the lip "C" on the flyback lever as shown in the photograph. Now replace shouldered screw SS-3. To replace shouldered screw SS-3, you will have to move the flyback lever away from the center of the watch until the hole in flyback lever sets over the hole in the minute register flyback lever. Then screw can be replaced.

REFERENCE: Minute register flyback lever is Assembly 17.
Seconds wheel and hour register flyback lever spring is Assembly 12.

C. FUNCTION OF SECONDS WHEEL AND HOUR REGISTER FLYBACK LEVER:

The function of this flyback lever is to contact the seconds wheel and the hour register wheel hearts and to force these wheels to return to a zero position.

REFERENCE: Seconds wheel is Assembly 8.
Hour register wheel is Assembly 19.

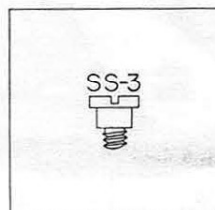

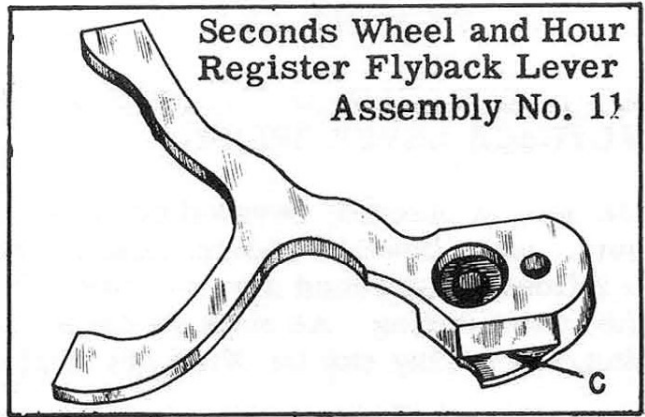

OILING
Slightly moisten the seconds wheel and hour register flyback lever with oil at these points:

1. Post on which the flyback lever pivots.
2. Point "C" that contacts flyback lever spring.

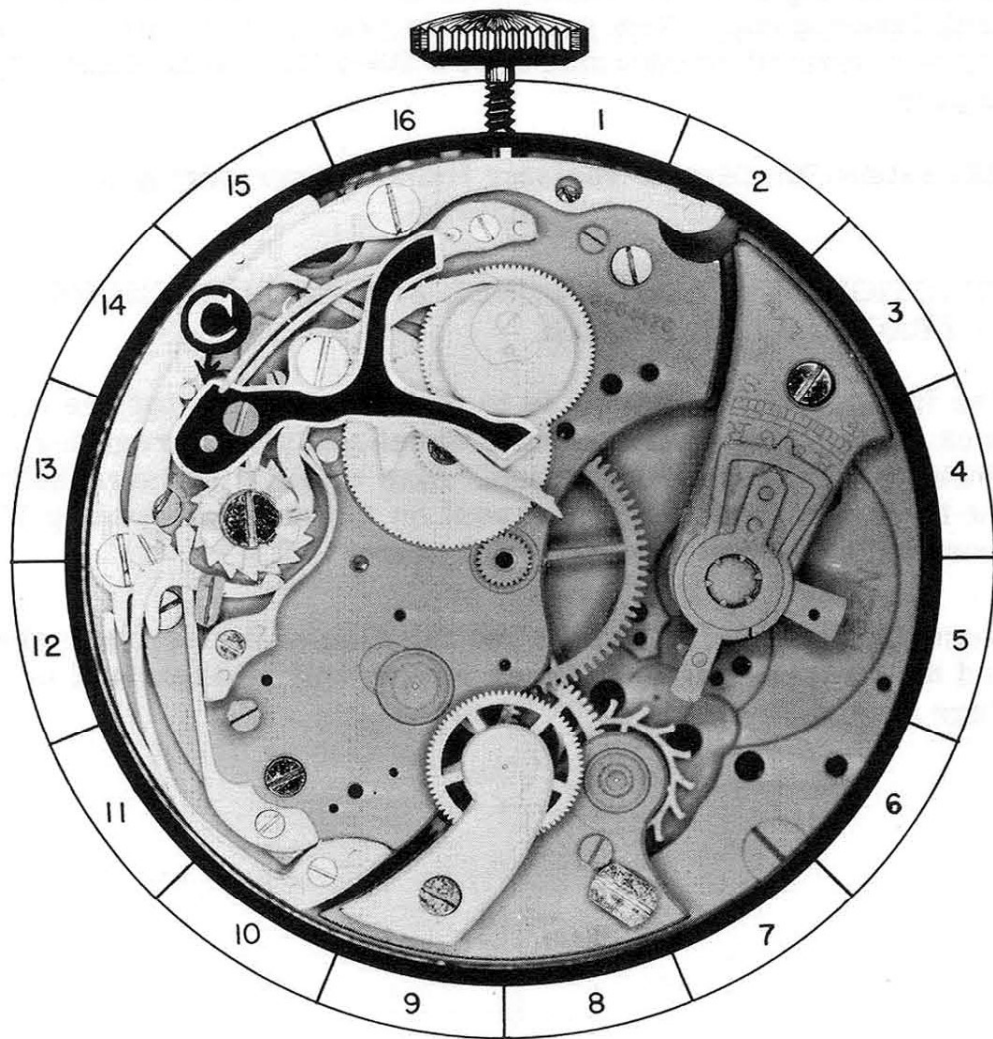

11-A

PART NO. 12

A. DISASSEMBLY PROCEDURE OF SECONDS WHEEL AND HOUR REGISTER FLYBACK LEVER SPRING:

This spring is held in place by beveled countersink screw BS-3 and steady pins. After beveled countersink screw BS-3 is removed, slide a finely-sharpened screw-driver between this spring and the lower spring. As soon as the spring is free from the steady pins, the spring can be lifted out of place.

(The shape of screw for this part is shown at bottom of page.)

B. ASSEMBLY PROCEDURE OF SECONDS WHEEL AND HOUR REGISTER FLYBACK LEVER SPRING:

Place the flyback lever spring in its proper position on the minute register flyback lever spring with the steady pin holes in this spring over the steady pins on the minute register flyback lever spring. Now press spring down to proper place and replace beveled countersink screw BS-3 that holds these springs in place.

REFERENCE: Minute register flyback lever spring is Assembly 16.

C. FUNCTION OF SECONDS WHEEL AND HOUR REGISTER FLYBACK LEVER SPRING:

The function of this spring is to make it possible for the flyback lever to bring the seconds wheel and minute register wheel to an exact zero position. Also this spring helps hold the flyback lever down on the post on the plate preventing it from riding up and coming out of place.

More detailed explanation on the function of the seconds wheel and hour register flyback lever spring will be explained on Page 32.

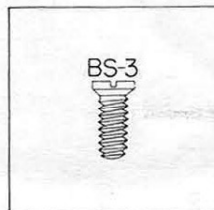

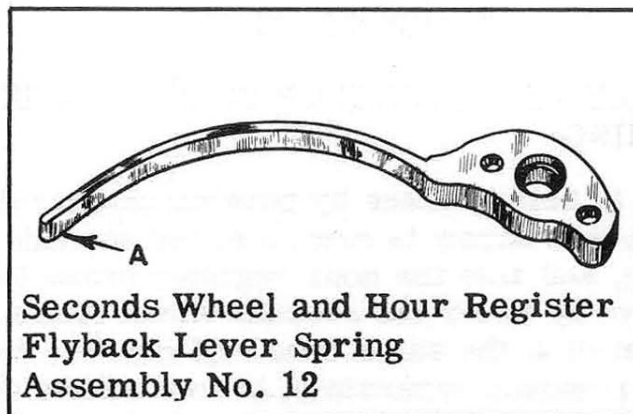

OILING

The seconds wheel and hour register flyback lever spring should not be oiled.

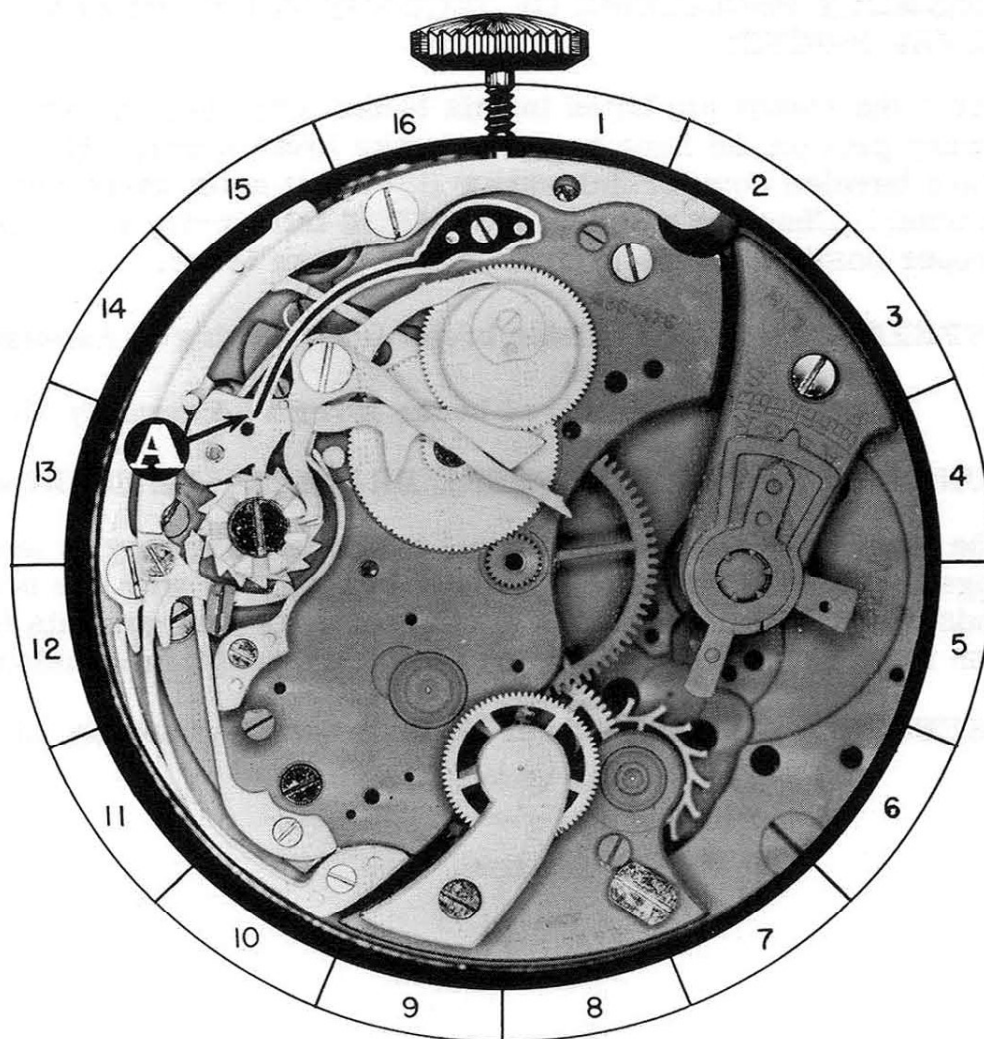

PART NO. 13

A. DISASSEMBLY PROCEDURE OF SECONDS WHEEL BRAKE LEVER SPRING:

This spring is held in place by beveled countersink screw BS-4. When this screw is removed, the seconds wheel brake lever spring, and also the hour register brake lever spring which is directly under the seconds wheel brake lever spring, can be removed at the same time. Of course, these parts can also be removed separately, but we advise that these parts be removed together. To remove these parts, slide a finely-sharpened screw-driver between the hour register brake lever spring and the plate loosening these two springs from the plate. After the steady pins are free in the holes in the plate, these springs can be lifted out of place.

(The shape of screw for this part is shown at bottom of page.)

B. ASSEMBLY PROCEDURE OF SECONDS WHEEL BRAKE LEVER SPRING:

Place the steady pin holes in this brake lever spring over the steady pins on the hour register brake lever spring. Now replace beveled countersink screw BS-4 that holds these springs in place. Check to see that end "A" of this spring is in its proper position on the seconds wheel brake lever.

REFERENCE: Hour register brake lever spring is Assembly 14.

Seconds wheel brake lever is Assembly 15.

C. FUNCTION OF SECONDS WHEEL BRAKE LEVER SPRING:

The function of the seconds wheel brake lever spring is to engage the end "B" of seconds wheel brake lever with the seconds wheel. Of course, this spring can only perform this function when permitted to do so by the chronograph mechanism.

REFERENCE: Seconds wheel brake lever is Assembly 15.

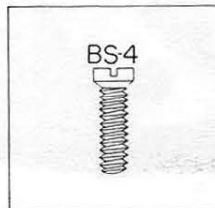

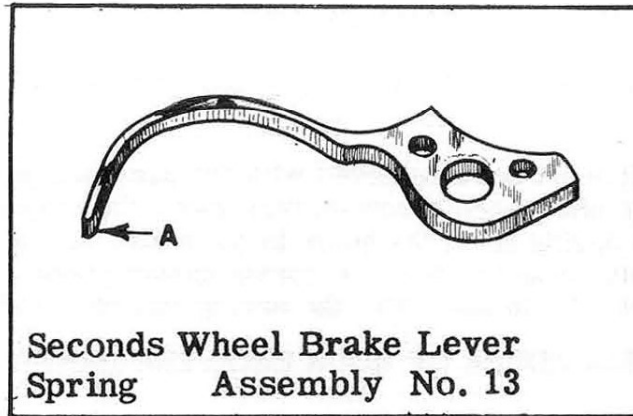

OILING

End "A" of seconds wheel brake lever spring should be slightly moistened with oil at point of contact with seconds wheel brake lever.

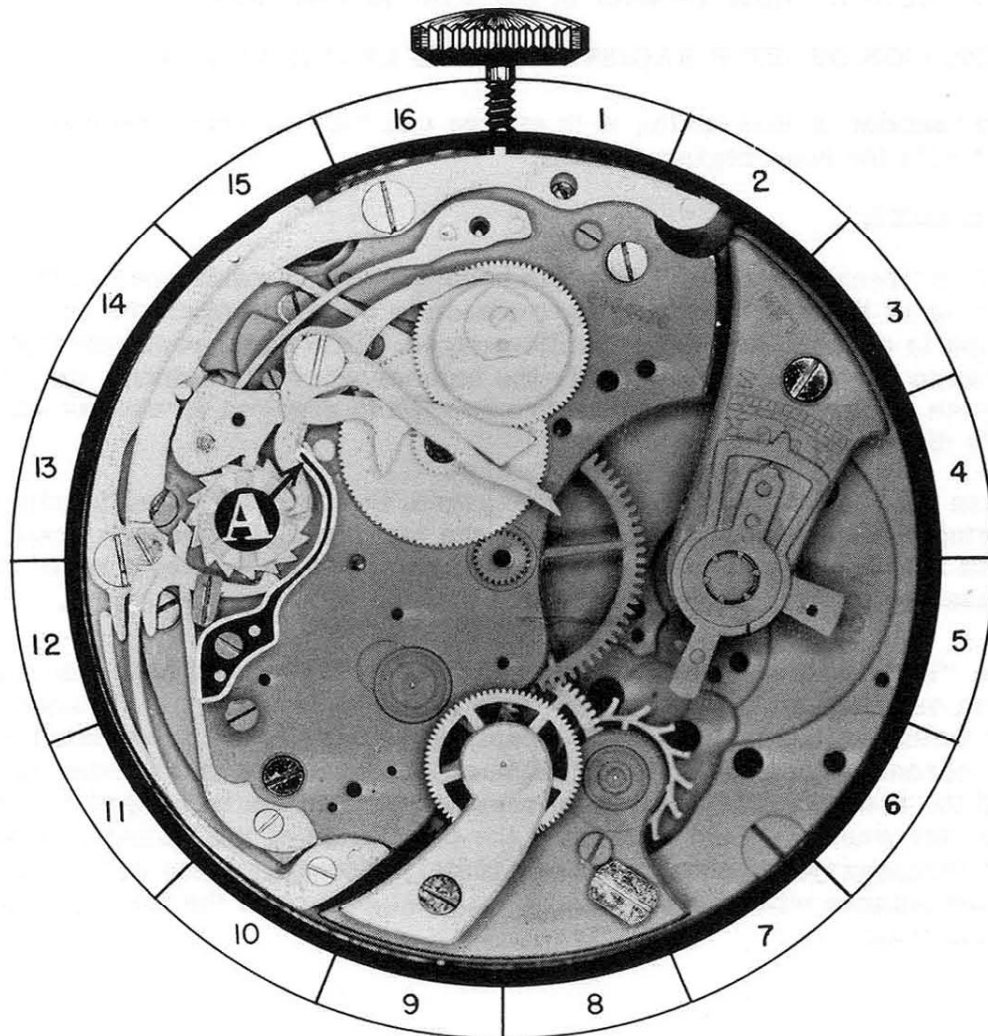

13-A

PART NO. 14

A. DISASSEMBLY PROCEDURE OF HOUR REGISTER BRAKE LEVER SPRING:

If this spring has not been removed with the previous part, remove it by sliding a finely-sharpened screw-driver under the spring loosening the steady pins on spring from the holes in the plate. At the same time, hold finger over spring so that the spring cannot shoot away. After steady pins are free in the plate, the spring can be lifted out of place.

B. ASSEMBLY PROCEDURE OF HOUR REGISTER BRAKE LEVER SPRING:

Place the hour register brake lever spring in its proper position on the plate, with the steady pins over the proper holes in the plate. Now press spring down to proper place. The end "A" of spring does not have to be in its proper position at this point. After the spring is pressed down to the proper place, grip end "A" of spring with a pair of tweezers and place end "A" of spring in contact with surface "C" on hour register brake lever.

REFERENCE: Hour register brake lever is Assembly 18.

C. FUNCTION OF HOUR REGISTER BRAKE LEVER SPRING:

The function of this spring is to engage end "A" of brake lever in contact with the hour register wheel.

REMARKS:

In this "center register" type of chronograph, the resistance to the turning of the watch train is approximately the same when the chronograph is engaged or when it is disengaged. This equal resistance offered to the watch train permits the balance wheel to maintain the same degree of oscillation when the chronograph is engaged as well as when it is disengaged.

When this type of chronograph is engaged, the seconds wheel tension spring holds a certain resistance to the turning of the seconds wheel. With the chronograph mechanism disengaged, there is also a resistance caused by the minute register wheel and the hour register wheel.

The "semi-instantaneous" type of chronograph does not have this uniform oscillation of the balance. This is due to the heavy resistance to the watch train when the chronograph is registering. The resistance of the chronograph wheels, the friction of the seconds wheel tension spring and the resistance of the minute register pawl to the turning of minute register wheel all tend to shorten the oscillation of the balance. When the chronograph mechanism is completely disengaged, the oscillation of the balance will increase due to less resistance to the turning of the watch train.

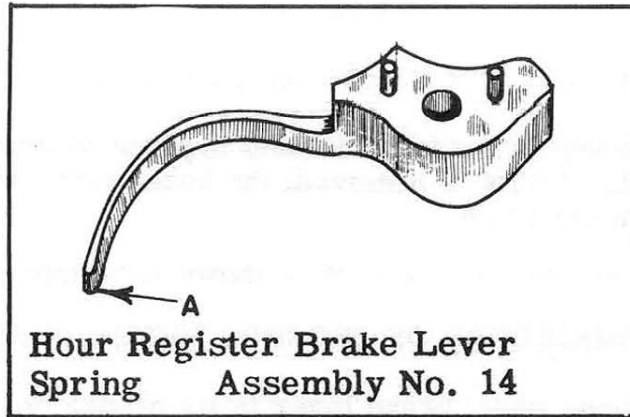

OILING

End "A" of hour register brake lever spring should be slightly moistened with oil at point of contact with hour register brake lever.

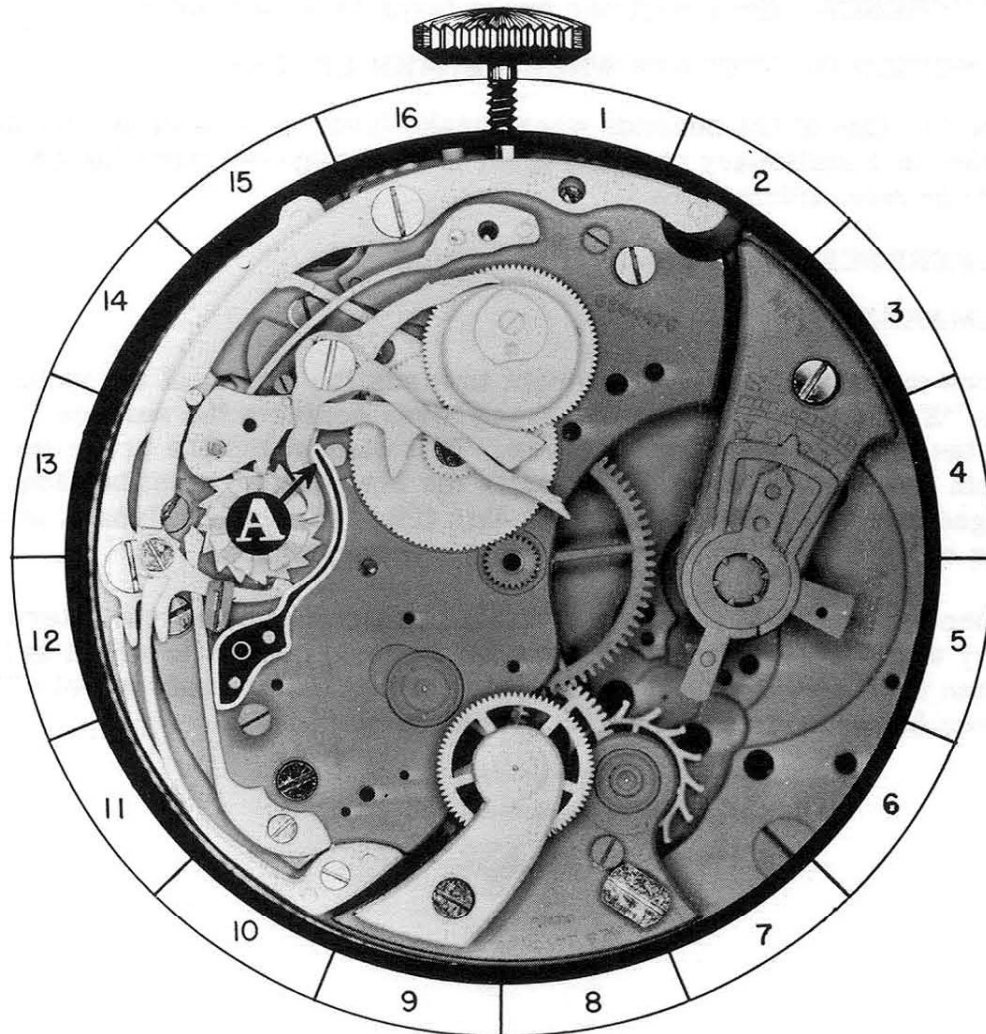

14-A

PART NO. 15

A. DISASSEMBLY PROCEDURE OF SECONDS WHEEL BRAKE LEVER:

The seconds wheel brake lever is held in place by shouldered screw SS-4. When this screw is removed, the brake lever will be free and can be lifted out of place.

(The shape of screw for this part is shown at bottom of page.)

B. ASSEMBLY PROCEDURE OF SECONDS WHEEL BRAKE LEVER:

Place the seconds wheel brake lever in its proper position on the hour register brake lever. The end "A" of brake lever must be in contact with the columns of the castle wheel. Now replace shouldered screw SS-4 that holds this part in place. After shouldered screw SS-4 is replaced, check to see that the seconds wheel brake lever and hour register brake lever pivots freely under head of this screw. This shouldered screw SS-4 holds the seconds wheel brake lever, also the hour register brake lever in place.

REFERENCE: Hour register brake lever is Assembly 18.

C. FUNCTION OF SECONDS WHEEL BRAKE LEVER:

The function of the seconds wheel brake lever is to hold the seconds wheel in a stationary position when it is disengaged from the chronograph mechanism.

REFERENCE: Seconds wheel is Assembly 8.

REMARKS:

When the flyback lever is brought towards the center of the watch, pin "E" on minute register flyback lever contacts the surface "D" on the seconds wheel brake lever. This disengages the brake lever from the seconds wheel. Naturally the brake lever must be disengaged from the seconds wheel at this time, so that the flyback lever can bring the seconds wheel back to a zero position.

When the castle wheel is turned to a position to permit the intermediary wheel to engage with the seconds wheel, the castle wheel at the same time disengages the brake lever from the seconds wheel. This frees the seconds wheel so that it can turn.

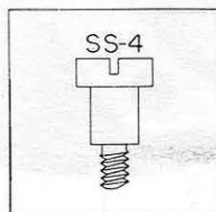

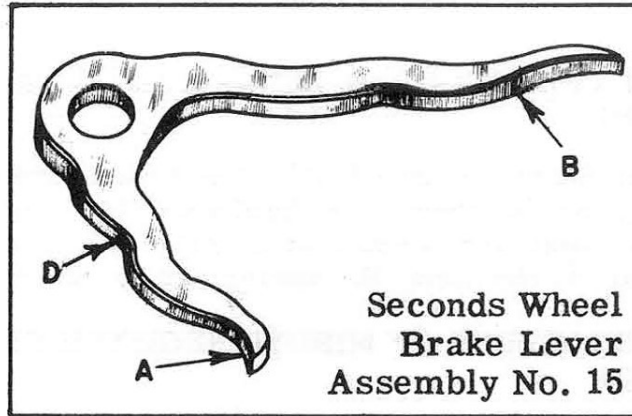

OILING

These points on seconds wheel brake lever should be slightly moistened with oil:

1. Shoulder of screw on which brake lever pivots.
2. Surface "D" that contacts pin "E" on minute register flyback lever.

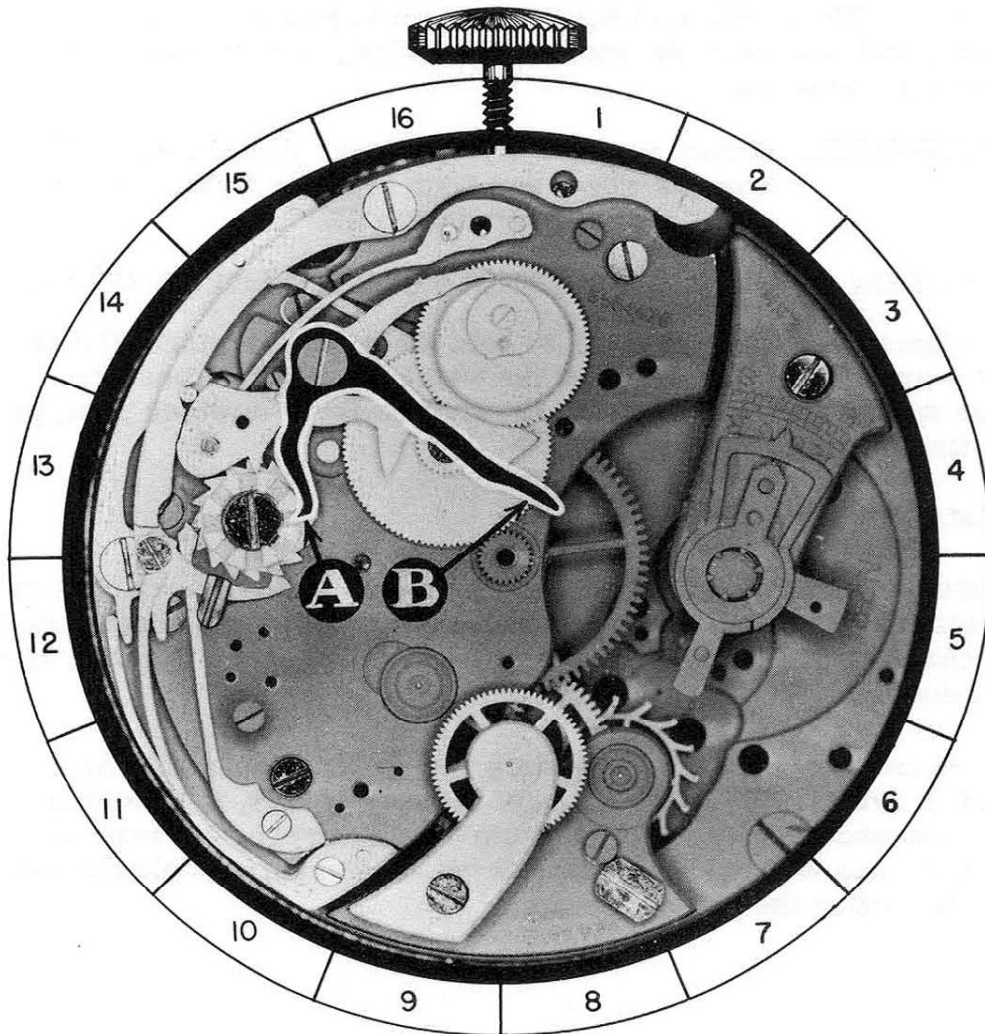

15-A

PART NO. 16

A. DISASSEMBLY PROCEDURE OF MINUTE REGISTER FLYBACK LEVER SPRING:

To remove this spring, slide a finely-sharpened screw-driver under the spring. At the same time, hold your finger on this spring, as it may shoot away and become lost. After the steady pins are free in the holes in the plate, the spring can be lifted out of place.

B. ASSEMBLY PROCEDURE OF MINUTE REGISTER FLYBACK LEVER SPRING:

Place flyback lever spring in its proper position with the end "A" of this spring on the inside of screw "C" on the minute register flyback lever. Now grip the two steady pins on the top of the flyback lever spring with a pair of tweezers and place steady pin "B" so that it will begin to enter its hole. Now with the tweezers holding the two upper steady pins, move the spring in such a manner as to force the steady pin "C" into its proper hole, at the same time pressing down on the spring. The spring will then snap in place. The screw that holds this part in place will not be replaced until the seconds wheel and hour register flyback lever spring is replaced.

REFERENCE: Minute register flyback lever is Assembly 17.
Seconds wheel and hour register flyback lever spring is Assembly 12.

C. FUNCTION OF MINUTE REGISTER FLYBACK LEVER SPRING:

The function of this spring is to hold the minute register flyback lever away from the center of the watch in a neutral position. This spring also helps to hold the flyback lever down on post, preventing it from riding up.

REMARKS:

A spring should just hold enough tension on a part to perform its function properly. Any excess tension on a part in a chronograph mechanism will cause the chronograph to be harder to work, also causing more wear, etc.

Of course, the amount of pressure the spring should hold on a part is determined at the factory; because of this, it is seldom that you should have to adjust a spring. However, you may have to make one of these springs, and the above remarks should aid you in setting the proper tension.

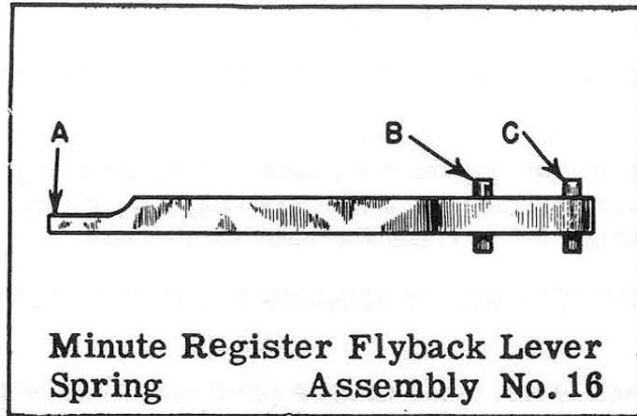

Minute Register Flyback Lever
Spring Assembly No. 16

OILING

End "A" of minute register flyback lever spring should be slightly moistened with oil at point of contact with screw "C" on minute register flyback lever.

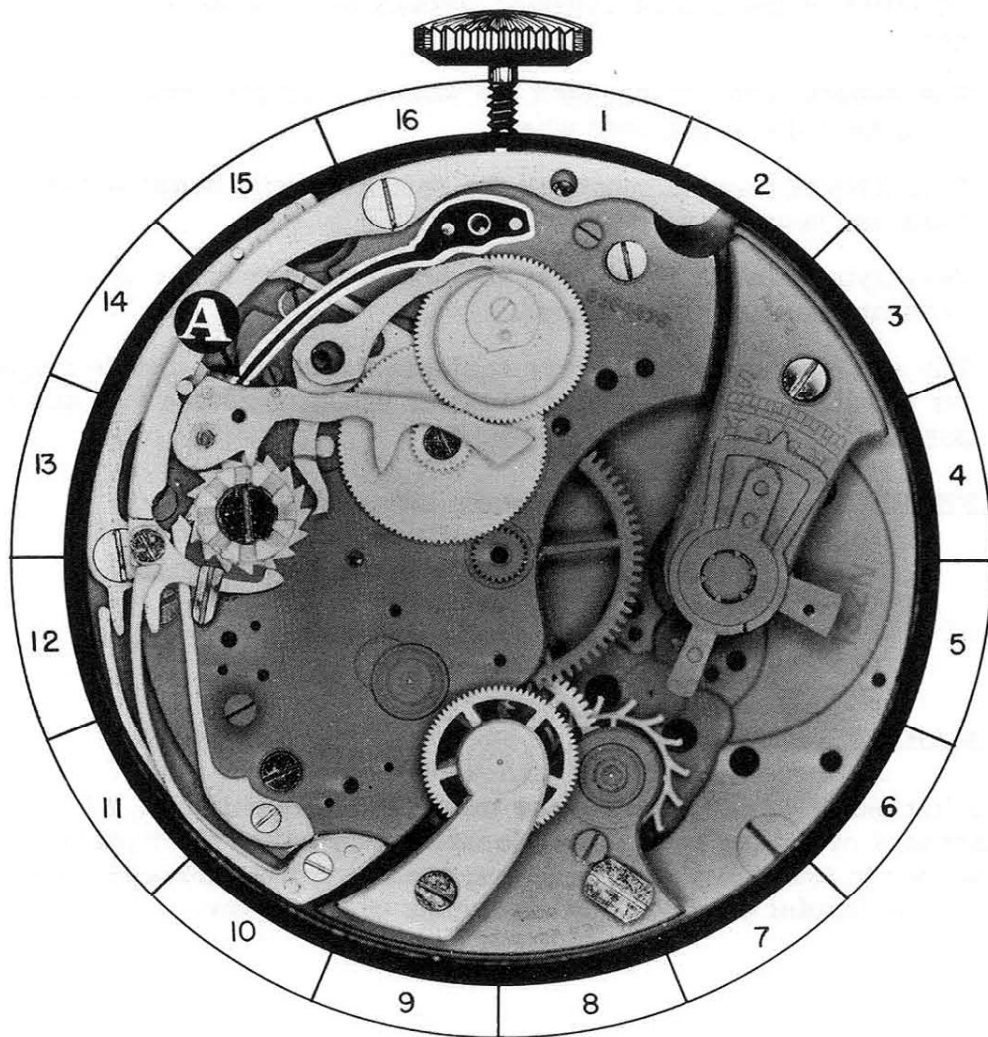

16-A

PART NO. 17

A. DISASSEMBLY PROCEDURE OF MINUTE REGISTER FLYBACK LEVER:

To remove the minute register flyback lever, simply grip flyback lever with a pair of tweezers and lift straight up on it. This will remove the flyback lever from the post on the plate.

B. ASSEMBLY PROCEDURE OF MINUTE REGISTER FLYBACK LEVER:

Place the flyback lever in its proper position on the plate with the hole in bushing of flyback lever over the post on the plate. At this point, make sure the castle wheel is at the proper position so that end "B" of flyback lever will fall in between two columns on the castle wheel. Now press the flyback lever down in proper place.

REFERENCE: Castle wheel is Assembly 27.

C. FUNCTION OF MINUTE REGISTER FLYBACK LEVER:

The function of the minute register flyback lever is to do four things:

1. The flyback lever disengages the minute register brake lever from the minute register wheel.
2. This flyback lever disengages the seconds wheel brake lever from the seconds wheel.
3. This flyback lever disengages the hour register brake lever from the hour register wheel.
4. The end "A" of flyback lever contacts the heart of minute register wheel forcing the minute register wheel to return to a zero position.

REFERENCE: Minute register brake lever is Assembly 6.
Minute register wheel is Assembly 10.
Seconds wheel brake lever is Assembly 15.
Seconds wheel is Assembly 8.
Hour register brake lever is Assembly 18.
Hour register wheel is Assembly 19.

REMARKS:

The flat end "A" of flyback lever must be highly polished, as any roughness or pits of rust at this location may cause the flyback lever not to function properly. When polishing this end of flyback lever, be careful not to change the shape of this lever.

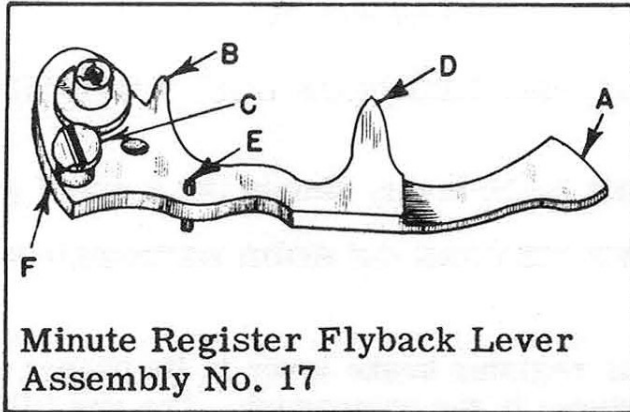

OILING

Slightly moisten minute register flyback lever with oil at these points:

1. The post on which flyback lever pivots.
2. The pin 'E' at point of contact with hour register brake lever and seconds wheel brake lever.
3. The surface 'F' that contacts post 'C' on push piece for setting back to zero.

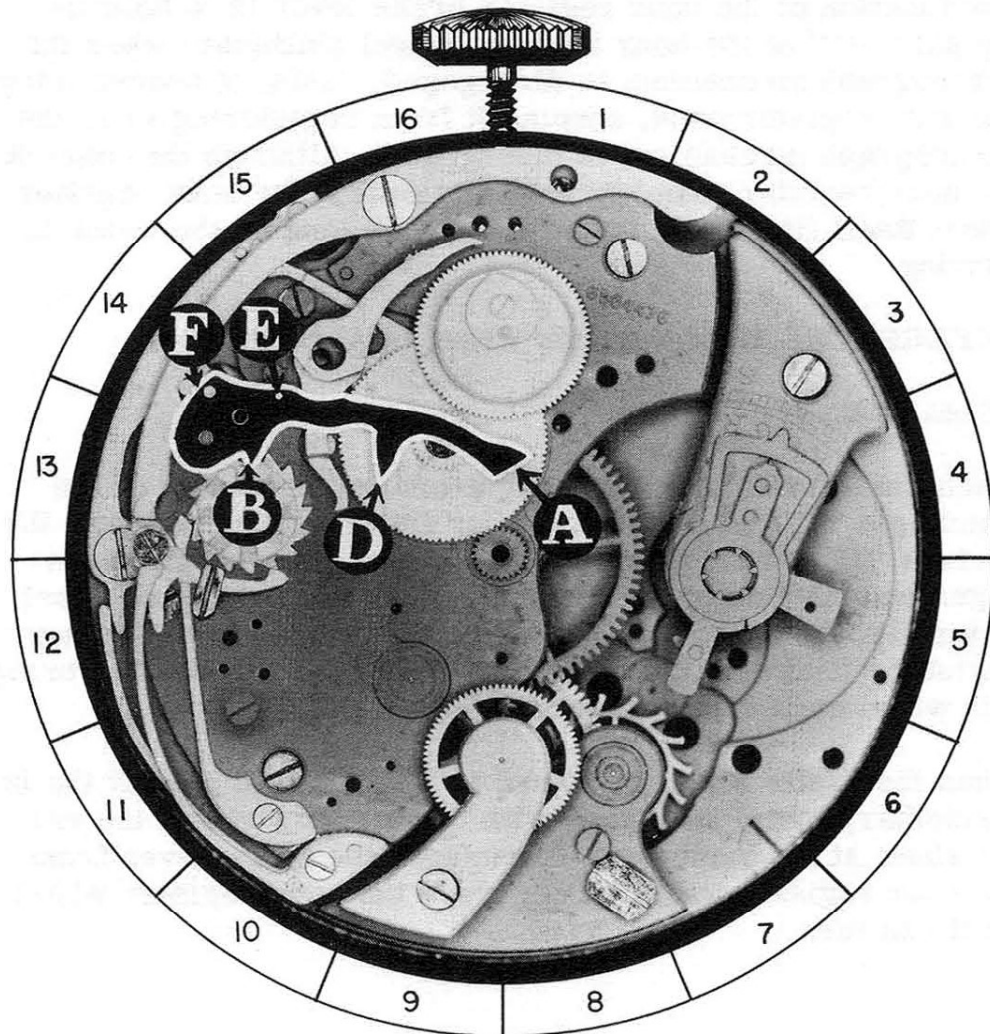

17-A

PART NO. 18

A. DISASSEMBLY PROCEDURE OF HOUR REGISTER BRAKE LEVER:

To remove this brake lever, simply lift it out of place.

B. ASSEMBLY PROCEDURE OF HOUR REGISTER BRAKE LEVER:

Place the hour register brake lever in its proper position on the plate as shown in the photograph. The end "B" of the brake lever should be in contact with the columns of the castle wheel.

REFERENCE: Castle wheel is Assembly 27.

C. FUNCTION OF HOUR REGISTER BRAKE LEVER:

The function of the hour register brake lever is to hold the top part "C" of the hour register wheel stationary when the chronograph mechanism is disengaged. This, of course, stops the hour register hand, keeping it from registering when the chronograph mechanism is disengaged. Although this part of the hour register wheel is held stationary, the hour register wheel itself (the teeth) keeps turning as long as the watch is running.

REFERENCE: Hour register wheel is Assembly 19.

REMARKS:

When the flyback lever is brought toward the center of the watch, pin "E" on minute register flyback lever contacts the surface "D" on the hour register brake lever. This disengages end "A" on brake lever from the hour register wheel. Naturally, the brake lever must be disengaged from the hour register wheel at this time so that the flyback lever can bring this wheel back to a zero position.

When the castle wheel is turned to a position to permit the intermediary wheel to engage with the seconds wheel, the castle wheel at the same time disengages the brake lever from the hour register wheel. This frees the hour register wheel so it can turn.

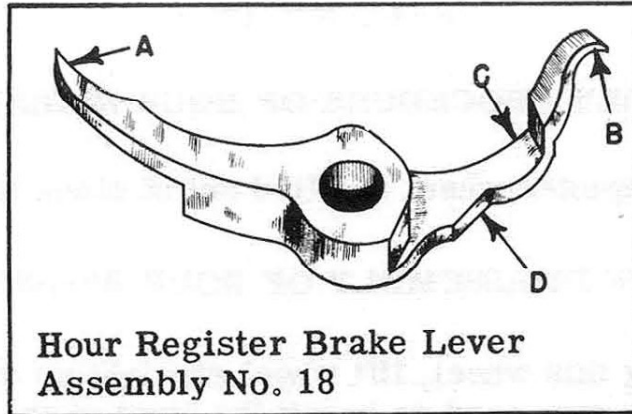

OILING

The shoulder of screw on which the hour register brake lever pivots should be slightly moistened with oil.

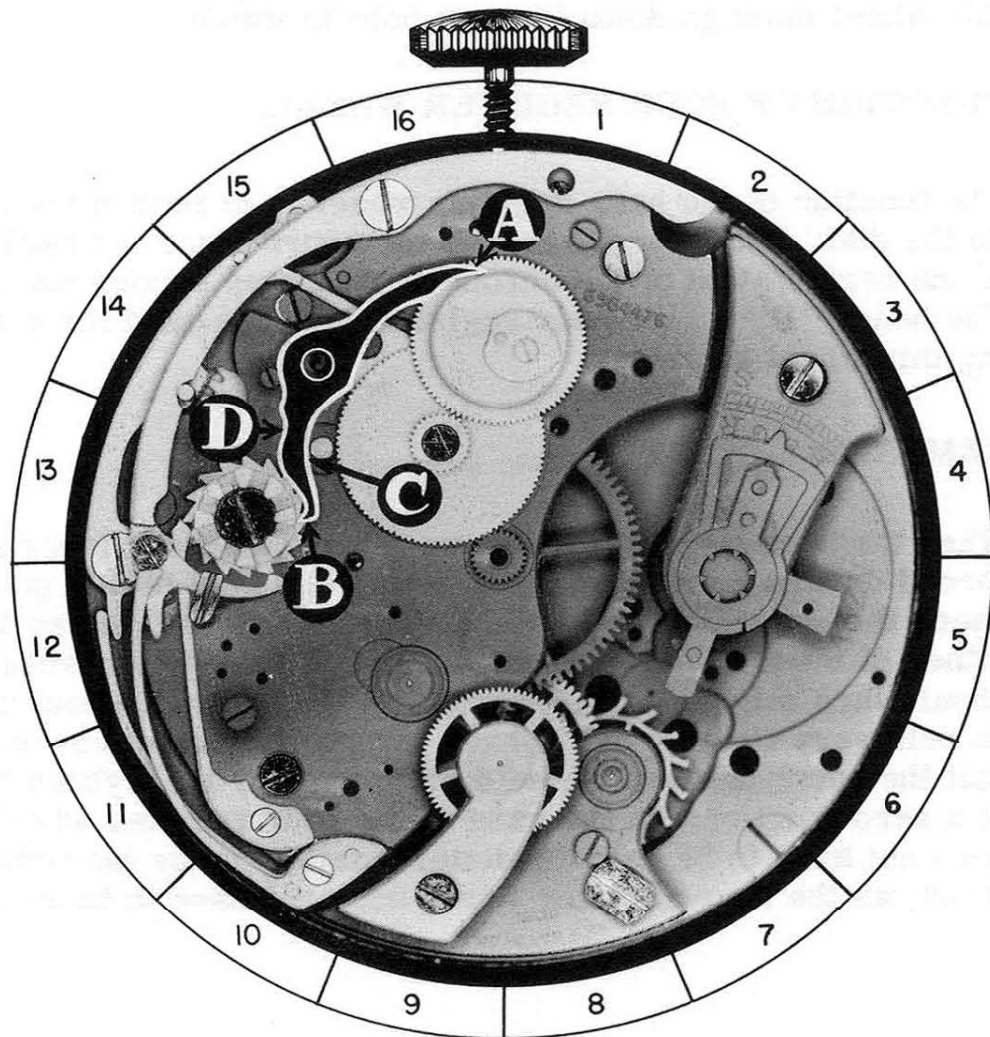

18-A

PART NO. 19

A. DISASSEMBLY PROCEDURE OF HOUR REGISTER WHEEL:

The hour register wheel is lifted out of place to remove it.

B. HAZARDS IN DISASSEMBLY OF HOUR REGISTER WHEEL:

In removing this wheel, lift wheel straight up out of watch, as any twisting may bend or break the pivot of the hour register wheel.

C. ASSEMBLY PROCEDURE OF HOUR REGISTER WHEEL:

Place the hour register wheel in its proper position in the watch as shown in the photograph. The long pivot "A" on this wheel must go down in pivot hole in watch.

D. FUNCTION OF HOUR REGISTER WHEEL:

The function of the hour register wheel is to record the hours on the dial. This wheel records the hours since the beginning of the registration of the chronograph sweep second hand. The heart "B" on the hour register wheel is used for returning this wheel to zero.

REMARKS:

When the seconds wheel and hour register flyback lever is forced toward the center of the watch and held in this position, check the seconds wheel and hour register wheel to see if either of these wheels will turn. The hour register wheel should turn slightly at this point, but the seconds wheel should be held very tight by the flyback lever. It is most essential that the seconds wheel be held stationary by the flyback lever at a zero position. In the case of the hour register wheel, it does not have to be held absolutely stationary by the flyback lever, as the hour register wheel does not have to be so exact

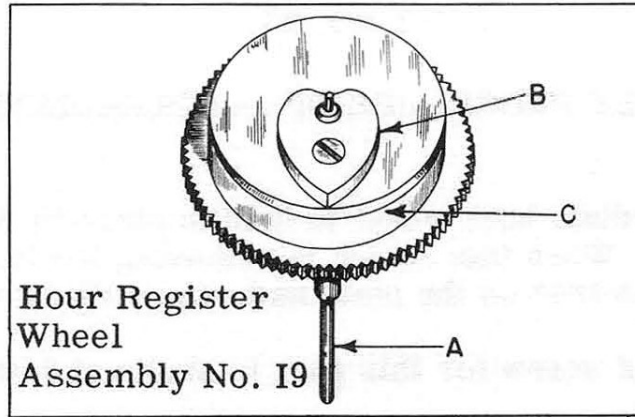

OILING

The bottom pivot on hour register wheel should be oiled before placing this wheel in watch. The top pivot should be oiled after bridge for this wheel is replaced.

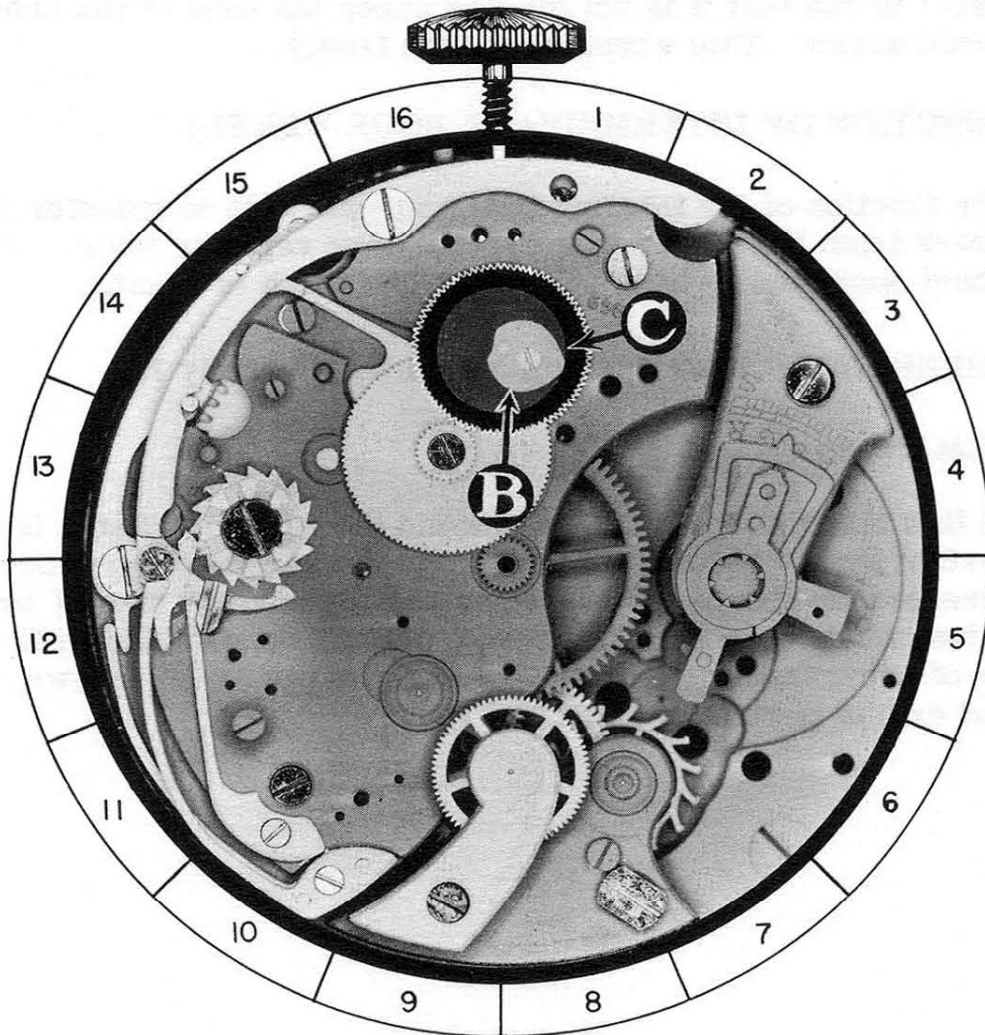

19-A

PART NO. 20

A. DISASSEMBLY PROCEDURE OF INTERMEDIATE HOUR WHEEL:

The intermediate hour wheel is held in place by shouldered screw SS-5. When this screw is removed, the intermediate hour wheel is free on the plate and can be lifted out of place.

(The shape of screw for this part is shown at bottom of page.)

B. ASSEMBLY PROCEDURE OF INTERMEDIATE HOUR WHEEL:

Place the intermediate hour wheel in its proper position on the plate as shown in the photograph. Now replace shouldered screw SS-5 that holds the intermediate hour wheel in place. After the screw is replaced, check the intermediate hour wheel to see that it is not binding under the head of the shouldered screw. This wheel must turn freely.

C. FUNCTION OF INTERMEDIATE HOUR WHEEL:

The function of the intermediate hour wheel is to transfer the power from the center wheel to the hour register wheel. This wheel continues to turn as long as the watch is running.

REFERENCE: Hour register wheel is Assembly 19.

REMARKS:

At this place, I would like to remind the repairer that it is important that in removing these parts the screw-driver and tweezers be sharpened correctly and the correct size of screw-driver blade used for each screw slot. This will eliminate a lot of unnecessary breakage, marring of plates or screws, and loss of parts.

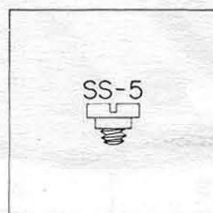

Intermediate Hour Wheel

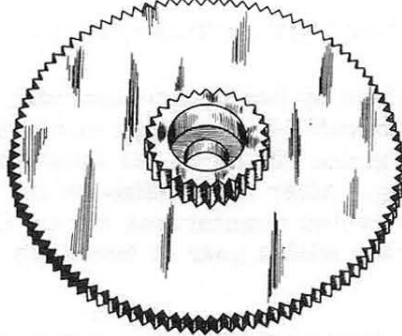

Assembly No. 20

OILING

The shoulder of screw on which the intermediate hour wheel pivots should be slightly moistened with oil.

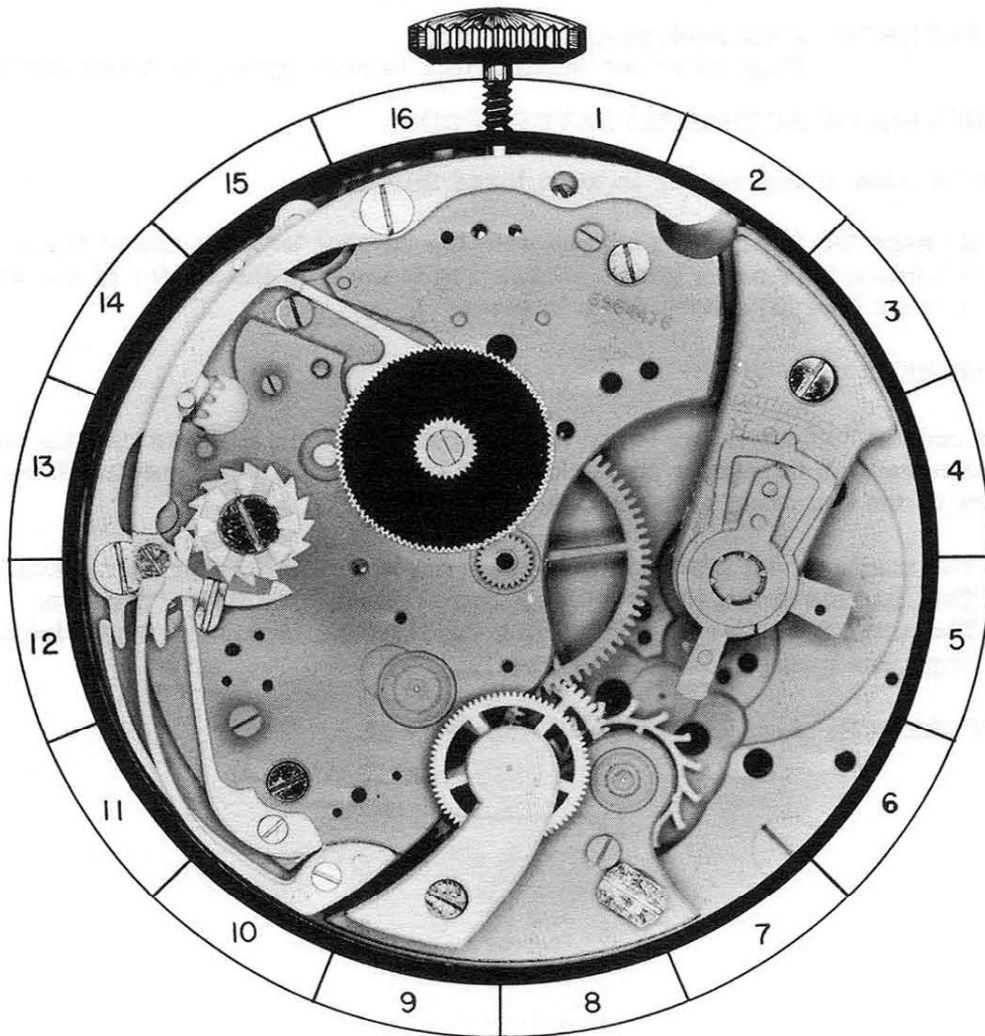

20-A

PART NO. 21

A. DISASSEMBLY PROCEDURE OF ACTUATING LEVER SPRING:

This spring is held in place by beveled countersink screw BS-5 and steady pins. Before removing beveled countersink screw BS-5, grip end "A" of the actuating lever spring and lift up on the actuating lever spring releasing the tension on this spring. After the tension on the actuating lever spring has been released, the beveled countersink screw BS-5 may now be removed. Grip the base of the spring with a pair of tweezers and lift spring out of place.

(The shape of screw for this part is shown at bottom of page.)

B. ASSEMBLY PROCEDURE OF ACTUATING LEVER SPRING:

Place the holes in the actuating lever spring over the steady pins on the push piece for setting back to zero spring. At this point, the end "A" of spring does not have to be in place. Now replace beveled countersink screw BS-5. But before tightening this screw, grip end "A" of this spring with a pair of tweezers and force end "A" of spring away from the center of the watch hooking this end on the joint hook in its proper position as shown in the photograph. Now tighten beveled countersink screw BS-5.

REFERENCE: Joint hook is Assembly 23.

Push piece for setting back to zero spring is Assembly 22.

C. FUNCTION OF ACTUATING LEVER SPRING:

The function of this spring is to do three things:

1. It keeps the joint hook engaged with the ratchet teeth on castle wheel.
2. It holds a tension on joint hook forcing it towards the center of the watch.
3. It helps hold joint hook down in place.

REMARKS:

The end "B" of actuating lever is sometimes hard to depress causing the chronograph to be harder to work by the operator. A combination of one or more of the following reasons can cause this:

1. The castle wheel pawl holding too strong a tension on the castle wheel.
This is considered the most important reason for this occurrence.
2. The actuating lever spring holding too strong a tension on actuating lever.
3. Improper oiling of the castle wheel.

REFERENCE: Actuating lever is Assembly 24.

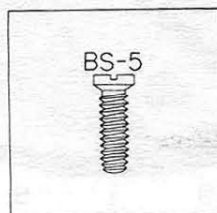

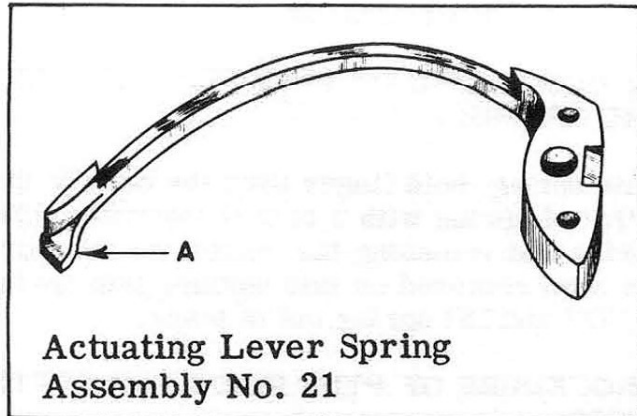

OILING

End "A" of actuating lever spring should be slightly moistened with oil at point of contact with joint hook.

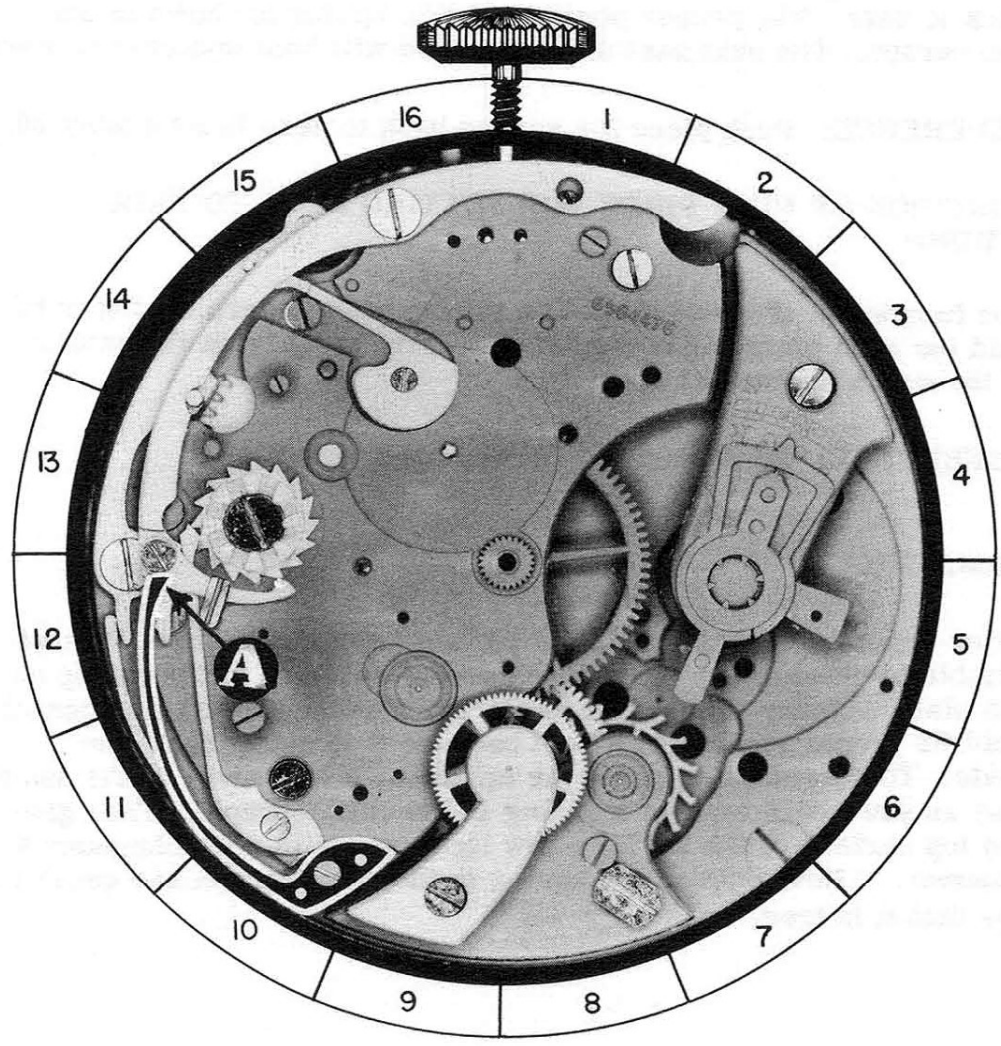

PART NO. 22

A. DISASSEMBLY PROCEDURE OF PUSH PIECE FOR SETTING BACK TO ZERO SPRING:

In removing this spring, hold finger over the base of the spring and grip end "A" of spring with a pair of tweezers, lifting up on end "A" of spring and releasing the tension on this spring. After the tension has been removed on this spring, grip spring by steady pins "B" and "C" and lift spring out of place.

B. ASSEMBLY PROCEDURE OF PUSH PIECE FOR SETTING BACK TO ZERO SPRING:

Place the steady pins on the spring in proper holes in the plate. The end "A" of spring at this point does not have to be in its proper position. After the steady pins are in the proper holes, hold finger over the base of the spring so that the steady pins cannot come out of the holes. Then grip end "A" of spring with a pair of tweezers and force end "A" of spring away from the center of the watch hooking it on the outside surface of push piece for setting back to zero. The proper position of this spring is shown in the photograph. The next part to be replaced will hold this part in place.

REFERENCE: Push piece for setting back to zero is Assembly 25.

C. FUNCTION OF PUSH PIECE FOR SETTING BACK TO ZERO SPRING:

The function of the push piece for setting back to zero spring is to hold the push piece for setting back to zero away from the center of the watch in a negative position.

REFERENCE: Push piece for setting back to zero is Assembly 25.

REMARKS:

After replacing the spring in the chronograph mechanism, it is advisable to check these springs to see that they are not scraping on the plate. Many times after replacing a spring, the spring cannot hold its proper tension on a part because it is scraping on the plate. To correct this, place the spring on a lead anvil in the same way as you would replace a spring in the chronograph. Then give the top surface of the spring a few light taps with a watchmaker's hammer. Now replace the spring in the chronograph and check to see that it is free.

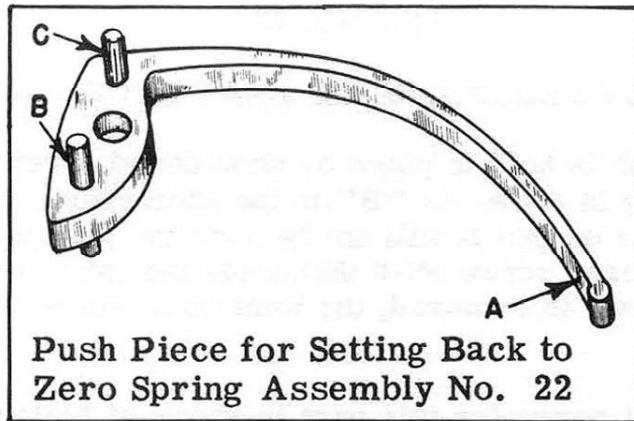

Push Piece for Setting Back to Zero Spring Assembly No. 22

OILING

End "A" of push piece for setting back to zero spring should be slightly moistened with oil at point of contact with push piece for setting back to zero.

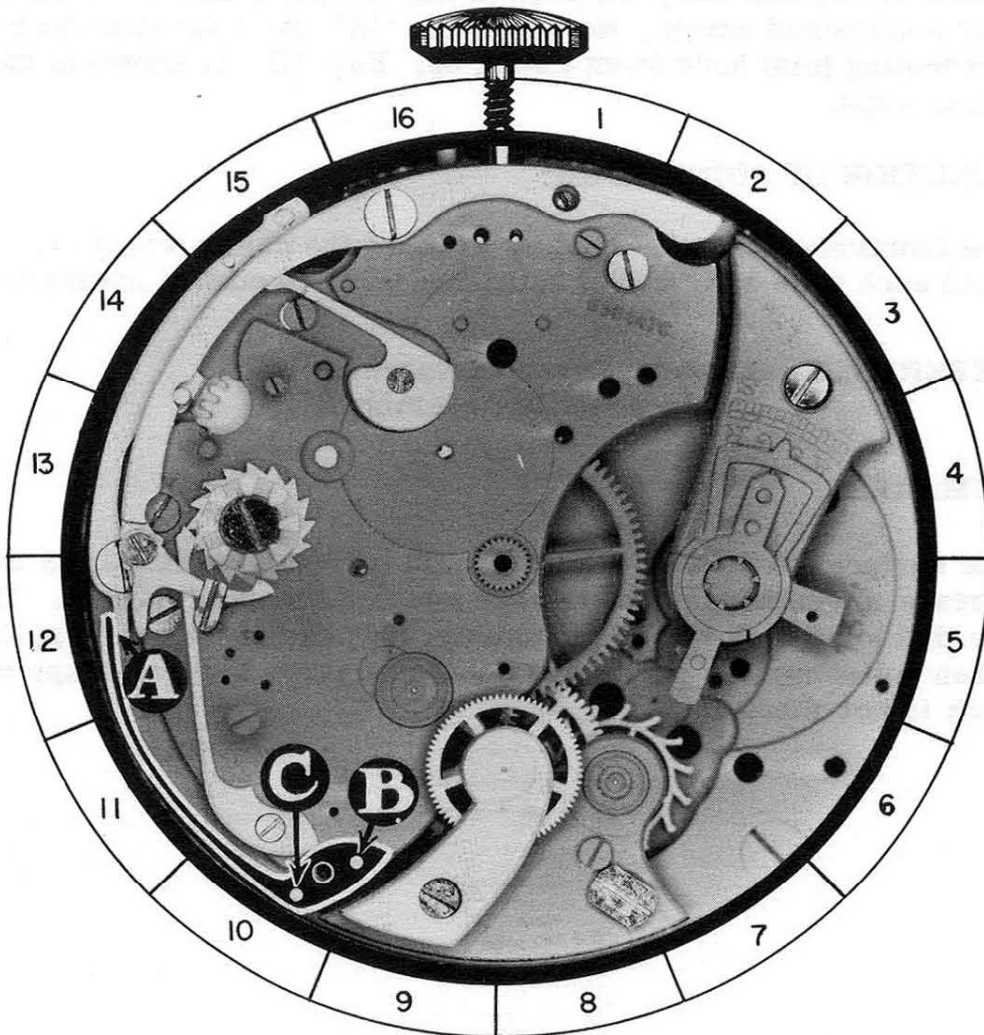

22-A

PART NO. 23

A. DISASSEMBLY PROCEDURE OF JOINT HOOK:

The joint hook is held in place by shouldered screw SS-6 and a key. The key is shown as "B" in the photograph. Now turn the key clockwise so that it will not be over the joint hook. Then remove shouldered screw SS-6 that holds the joint hook in place. After the screw is removed, the joint hook can be lifted out of place.

(The shape of screw for this part is shown at bottom of page.)

B. ASSEMBLY PROCEDURE OF JOINT HOOK:

Make sure the key "B" is in position so that the joint hook can be placed in the watch. The end "A" of the joint hook should be in contact with the ratchet teeth on the castle wheel. Now replace shouldered screw SS-6. After shouldered screw SS-6 is replaced, check to see that the joint hook is not binding under the head of this shouldered screw. Now turn key "B" over the joint hook, preventing joint hook from riding up. Key "B" is shown in the photograph.

C. FUNCTION OF JOINT HOOK:

The function of the joint hook is to move the castle wheel one tooth each time end "B" of actuating lever is pushed manually.

REFERENCE: Actuating lever is Assembly 24.
Castle wheel is Assembly 27.

REMARKS:

The surface "A" on joint hook should be highly polished, as this surface slides across the ratchet teeth on the castle wheel. Thus, for this joint hook to work smoothly, this surface must be polished. When polishing this part, care should be taken that the shape of hook is not changed.

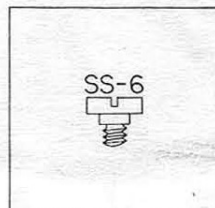

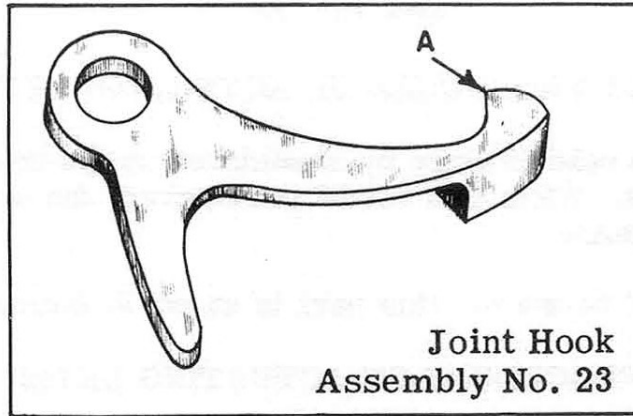

OILING

The shoulder of screw on which the joint hook pivots should be slightly moistened with oil.

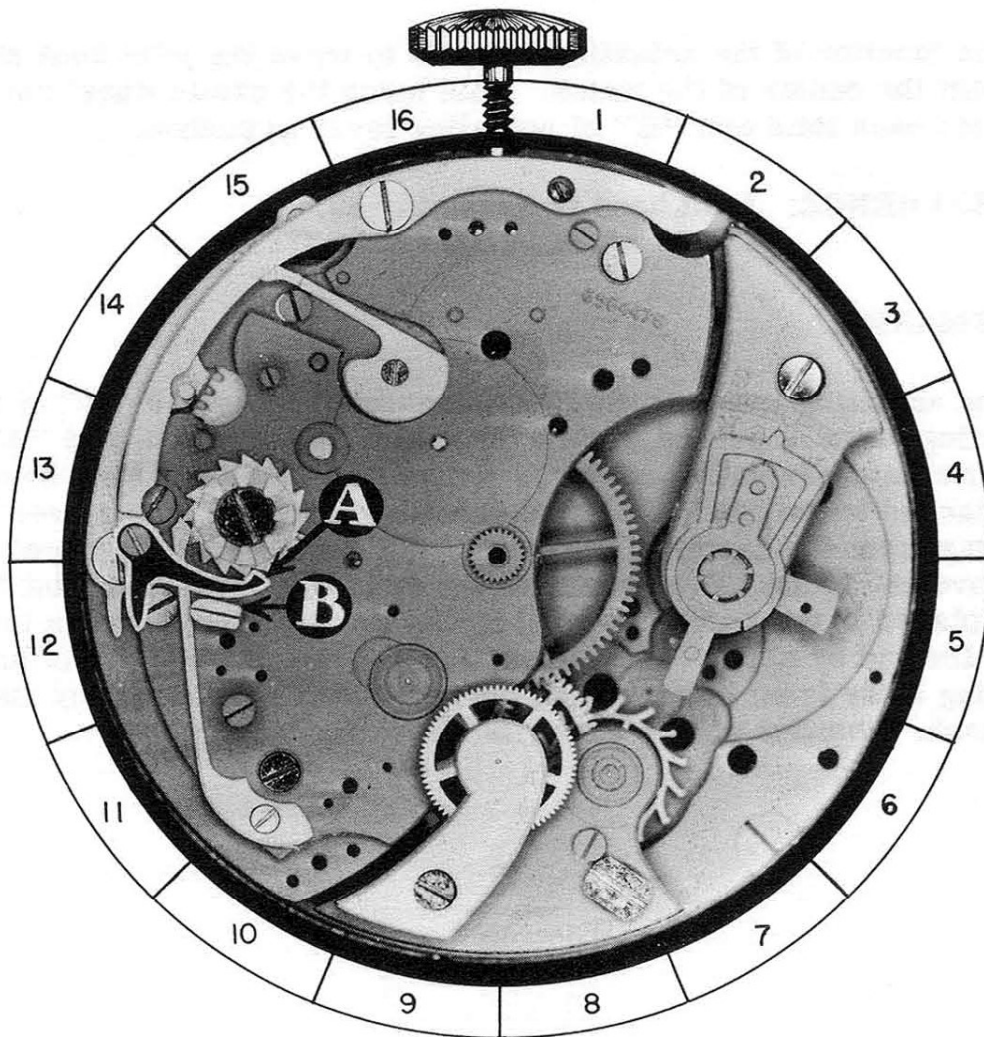

23-A

PART NO. 24

A. DISASSEMBLY PROCEDURE OF ACTUATING LEVER:

This lever is held in place by shouldered screw SS-7 and pivots on this screw. When this screw is removed, the lever may be lifted out of place.

(The shape of screw for this part is shown at bottom of page.)

B. ASSEMBLY PROCEDURE OF ACTUATING LEVER:

Place the actuating lever in its proper position on the plate as shown in the photograph. When the actuating lever is in its proper position, replace shouldered screw SS-7 that holds this lever in place. After the screw is replaced, actuating lever should be checked to see that it pivots freely under the head of this screw.

C. FUNCTION OF ACTUATING LEVER:

The function of the actuating lever is to move the joint hook away from the center of the watch. This turns the castle wheel one tooth each time end "B" of actuating lever is pushed.

REFERENCE: Joint hook is Assembly 23.
Castle wheel is Assembly 27.

REMARKS:

The actuating lever works like a see-saw. When end "B" of actuating lever is pushed toward the center of the watch, end "A" moves away from the center of the watch. The joint hook being attached to the end "A" of the actuating lever, is also moved away from the center of the watch. This causes castle wheel to move one tooth. When you have the actuating lever and joint hook replaced in the watch, you will notice the movement of this lever is limited by screw "C". This screw prevents end "B" of actuating lever from being forced too far towards the center of the watch. Position of this screw is shown in photograph.

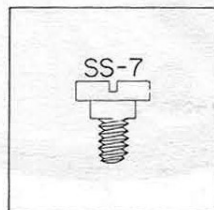

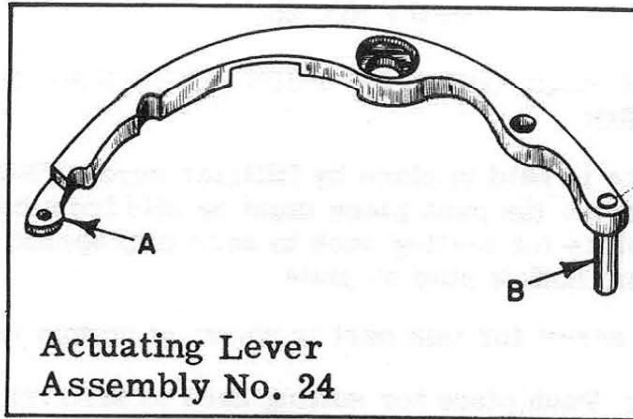

OILING

The shoulder of screw on which the actuating lever pivots should be slightly moistened with oil.

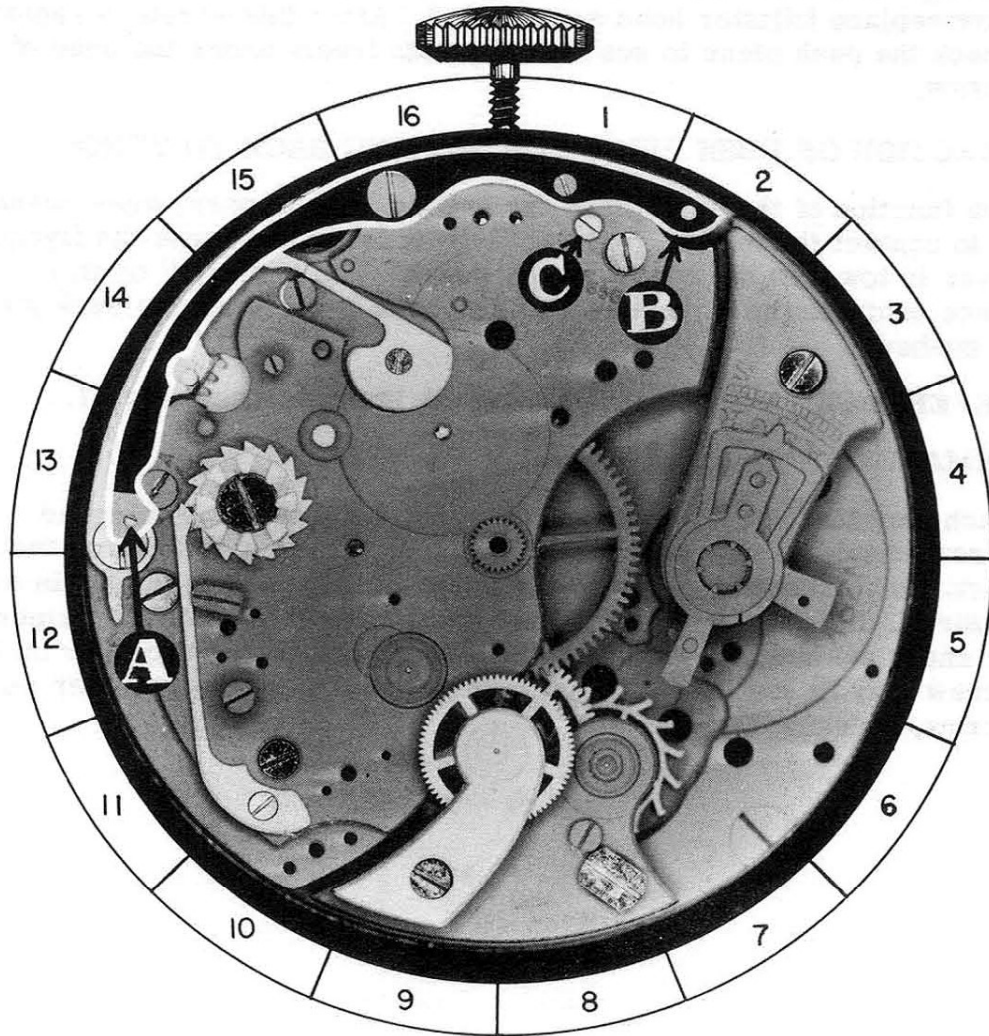

24-A

PART NO. 25

A. DISASSEMBLY PROCEDURE OF PUSH PIECE FOR SETTING BACK TO ZERO:

This push piece is held in place by fillister screw FS-3. When this screw is removed, the push piece must be slid from beneath the end "A" of push piece for setting back to zero trip spring. Now lift push piece from hollow stud on plate.

(The shape of screw for this part is shown at bottom of page.)

REFERENCE: Push piece for setting back to zero trip spring is Assembly 28.

B. ASSEMBLY PROCEDURE OF PUSH PIECE FOR SETTING BACK TO ZERO:

Place push piece for setting back to zero in its proper position on the plate as shown in the photograph. The pin "A" on the push piece must contact end "A" of the push piece for setting back to zero trip spring. The hole in push piece fits over the hollow stud in the plate. Now replace fillister head screw FS-3. After this screw is replaced, check the push piece to see that it pivots freely under the head of screw.

C. FUNCTION OF PUSH PIECE FOR SETTING BACK TO ZERO:

The function of the push piece for setting back to zero, when pushed, is to contact the minute register flyback lever and force the flyback lever in towards the center of the watch. The post "C" on this push piece contacts the minute register flyback lever when the push piece is pushed.

REFERENCE: Minute register flyback lever is Assembly 17.

REMARKS:

Each part that should move freely under head of the shouldered screw should be checked for the required freedom desired on that part. Any excess freedom to the point that the part is sloppy is not desired. In the case where a part has too much vertical movement or endshake under head of the shouldered screw, the shoulder on the screw may be too long. To correct this, cut back the shoulder on the screw, reducing the length of it.

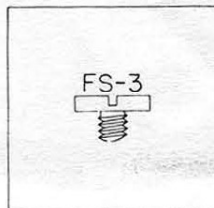

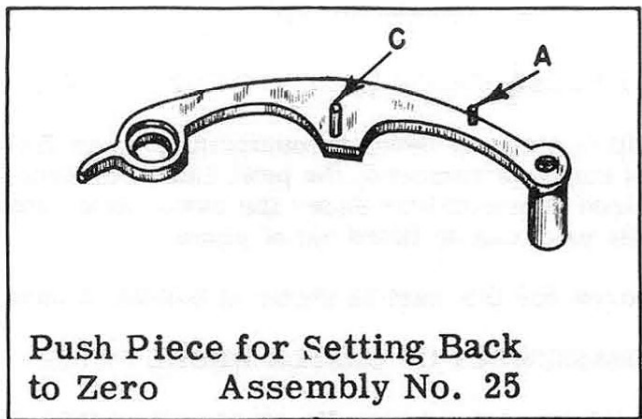

OILING

Slightly moisten push piece for setting back to zero with oil at these points:

1. The stud on plate on which the push piece pivots.
2. Pin "A" at point of contact with push piece for setting back to zero trip spring.

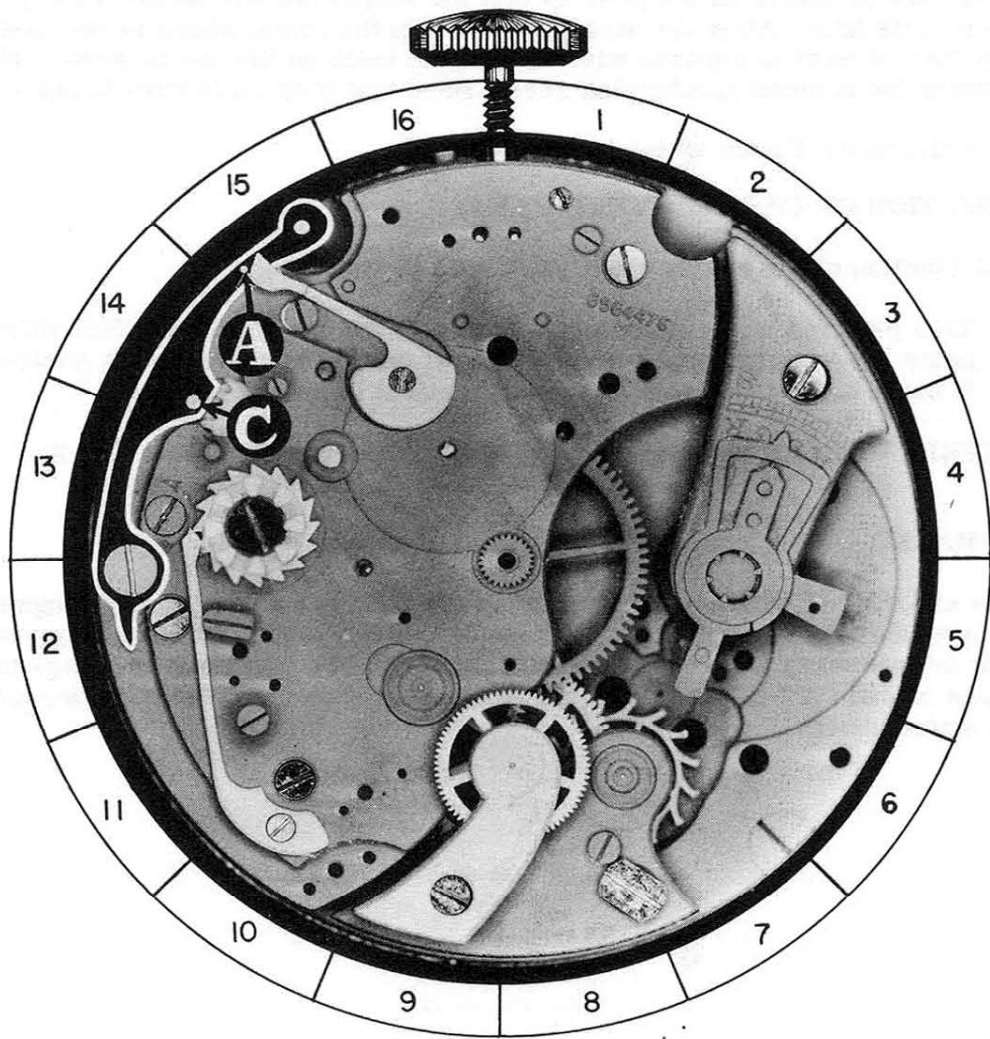

25-A

PART NO. 26

A. DISASSEMBLY PROCEDURE OF CASTLE WHEEL PAWL:

This pawl is held in place by beveled countersink screw BS-6 and steady pins. When this screw is removed, the pawl can be loosened from plate by sliding a thin-blade screw-driver under the pawl. After steady pins are free in plate, this pawl can be lifted out of place.

(The shape of screw for this part is shown at bottom of page.)

B. HAZARDS IN DISASSEMBLY OF CASTLE WHEEL PAWL:

When removing this pawl, hold your finger over it as this pawl can easily shoot away or become lost.

C. ASSEMBLY PROCEDURE OF CASTLE WHEEL PAWL:

Place pawl in its proper position on the plate with the steady pin "B" entering proper hole. You will have to apply a slight bit of pressure to the surface "D" on the pawl to force the steady pin "C" on pawl over its proper hole. When forcing surface "D" on pawl towards center of watch, hold a downward pressure on the pawl so that the steady pin will automatically drop in its hole. After the steady pins are in the holes, check to see that end "A" of pawl is engaged with the ratchet teeth on the castle wheel. Now replace the beveled countersink screw BS-6 that holds this pawl in place.

REFERENCE: Castle wheel is Assembly 27.

D. FUNCTION OF CASTLE WHEEL PAWL:

The function of the castle wheel pawl is to do two things:

1. This pawl correctly spaces the turning of the castle wheel. This eliminates the possibility of the castle wheel setting at an incorrect position.
2. It holds the castle wheel in position until it is moved manually.

REFERENCE: Ratchet teeth on the castle wheel are shown as "B" in isometric drawing No. 27.

REMARKS:

The end "A" of castle wheel pawl should be highly polished. Any roughness or pits of rust at this location may cause the pawl not to function properly. If it is necessary to polish this end, care should be taken not to change the shape of end "A" of pawl. It must be of correct shape to function properly as stated above.

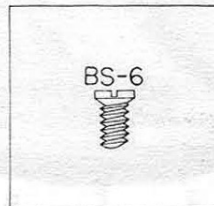

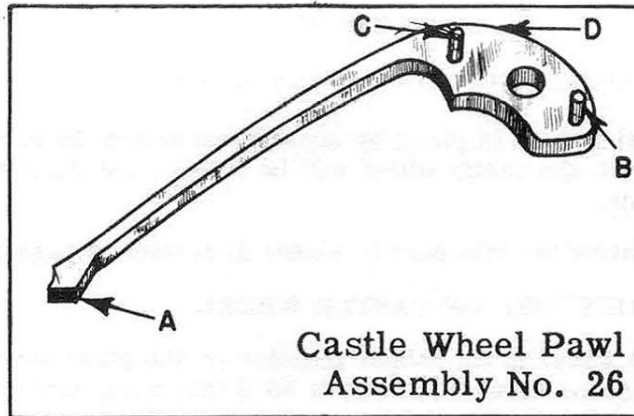

Castle Wheel Pawl
Assembly No. 26

OILING

The castle wheel pawl should not be oiled.

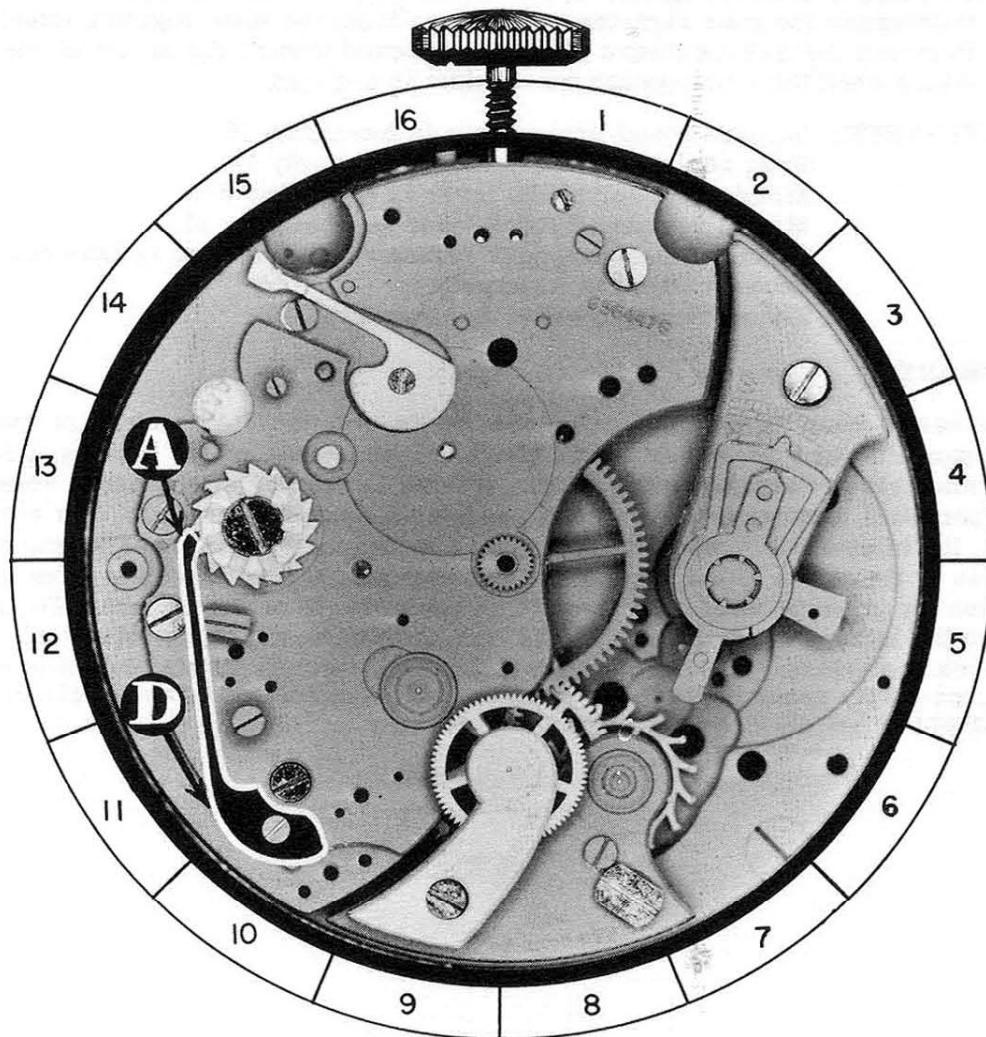

26-A

PART NO. 27

A. DISASSEMBLY PROCEDURE OF CASTLE WHEEL:

The castle wheel is held in place by shouldered screw SS-8. After this screw is removed, the castle wheel will be free on the plate and can be lifted out of place.

(The shape of screw for this part is shown at bottom of page.)

B. ASSEMBLY PROCEDURE OF CASTLE WHEEL:

Place the castle wheel in its proper position on the plate as shown in the photograph. Replace shouldered screw SS-8 that holds this wheel in place. Check to see that the castle wheel turns freely under head of this screw; also check to see that this wheel does not have excess freedom to the point that it is fitted sloppy.

C. FUNCTION OF CASTLE WHEEL:

The function of the castle wheel is to do five things:

1. Disengages the intermediary wheel from the seconds wheel.
2. Disengages the seconds wheel brake lever from the seconds wheel.
3. Disengages minute register brake lever from the minute register wheel.
4. Disengages the hour register brake lever from the hour register wheel.
5. Prevents the flyback levers from being moved toward the center of the watch when the chronograph mechanism is engaged.

REFERENCE: Seconds wheel brake lever is Assembly 15.
Hour register brake lever is Assembly 18.
Minute register brake lever is Assembly 6.
Minute register flyback lever is Assembly 17.
Seconds wheel and hour register flyback lever is Assembly 11.
Seconds wheel is Assembly 8.
Minute register wheel is Assembly 10.

REMARKS:

The castle wheel performs its function by the columns "A" which are evenly spaced around the center of the wheel. As the castle wheel is turned, the columns either force a part to move out from the center of the castle wheel or permit it to move into the empty spaces between two columns. For example, the intermediary wheel is disengaged from the seconds wheel by the columns of the castle wheel forcing end of chronograph pivoted detent from between the columns until the point of this detent rests on the column. To engage the intermediary wheel with the seconds wheel, the castle wheel is moved one space. This permits the end of chronograph pivoted detent to enter the empty space between the columns which permits the two wheels to be engaged by the chronograph pivoted detent.

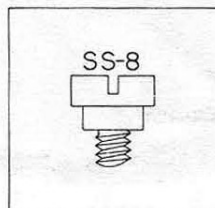

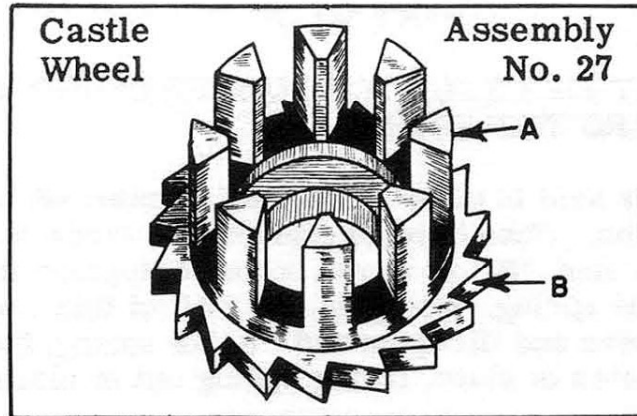

OILING

Slightly moisten the castle wheel with oil at these points:

1. Shoulder of screw on which the castle wheel pivots.
2. Columns "A" that contact parts of chronograph mechanism.
3. Ratchet teeth "B" on castle wheel.

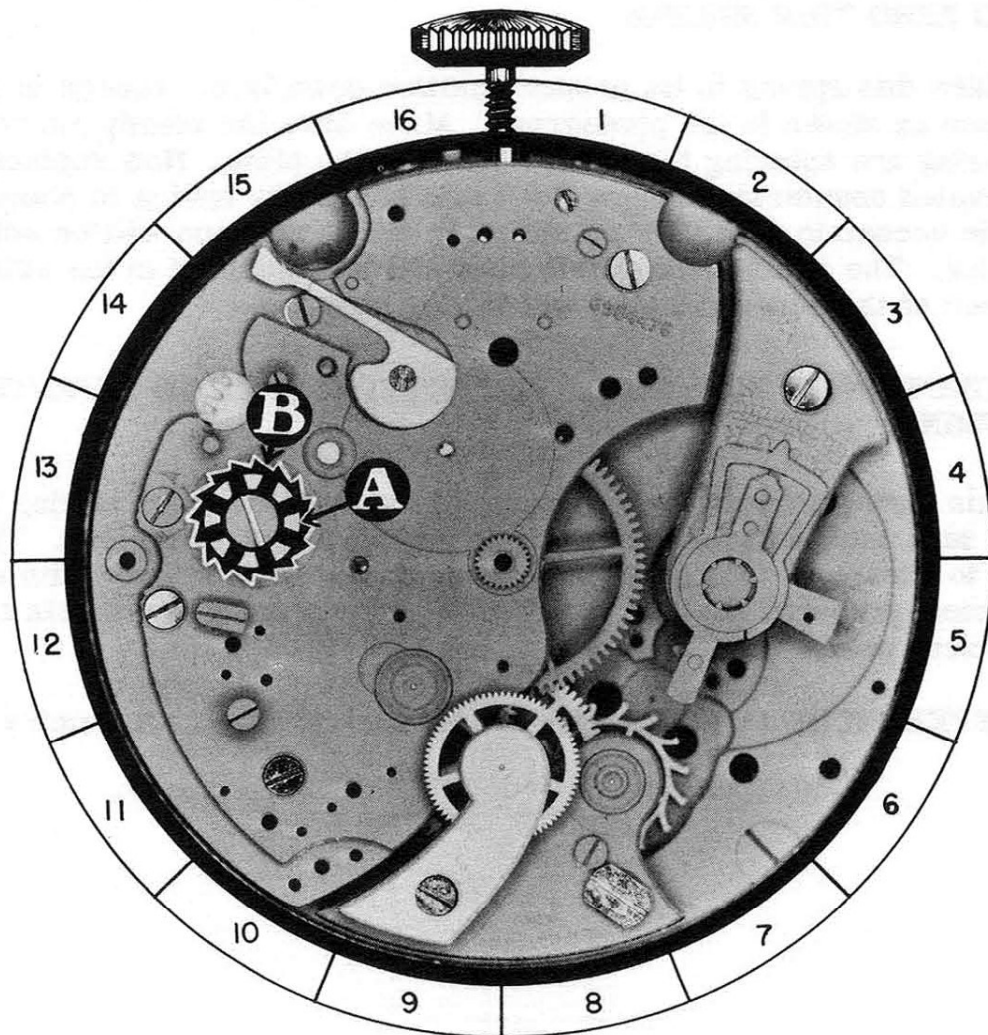

27-A

PART NO. 28

A. DISASSEMBLY PROCEDURE OF PUSH PIECE FOR SETTING BACK TO ZERO TRIP SPRING:

This spring is held in place by beveled countersink screw BS-7 and two steady pins. When beveled countersink screw is removed, turn the eccentric stud "B" as shown in the photograph to release the tension on this spring. Now grip end "A" of this spring with a pair of tweezers and lift up on end "A" of spring, freeing the steady pins in the holes of plate, lifting spring out of place.

When lifting up on end "A" of spring, the spring must be held level, as any tilting of the spring will cause the steady pins to bind in the holes, preventing the spring from coming out of place.

(The shape of screw for this part is shown at bottom of page.)

B. ASSEMBLY PROCEDURE OF PUSH PIECE FOR SETTING BACK TO ZERO TRIP SPRING:

Place this spring in its proper position down in the recess in the plate as shown in the photograph. Make sure the steady pins on the spring are entering the proper holes in the plate. Now replace beveled countersink screw BS-7 that holds this spring in place. The eccentric stud "B" as shown in the photograph will be adjusted later. The adjustment of this stud will be explained in the adjustment of the eccentric stud text in this book.

C. FUNCTION OF PUSH PIECE FOR SETTING BACK TO ZERO TRIP SPRING:

This spring retards the movement of the push piece for setting back to zero until sufficient pressure is applied to the push piece. This is to assure that the push piece contacts the flyback lever with sufficient pressure to force the flyback lever to bring the wheels back to zero position.

REFERENCE: Push piece for setting back to zero is Assembly 25.

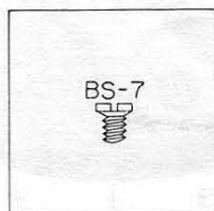

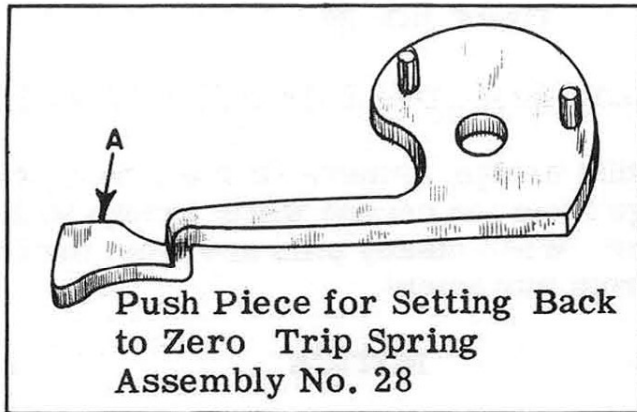

OILING

The push piece for setting back to zero trip spring should not be oiled.

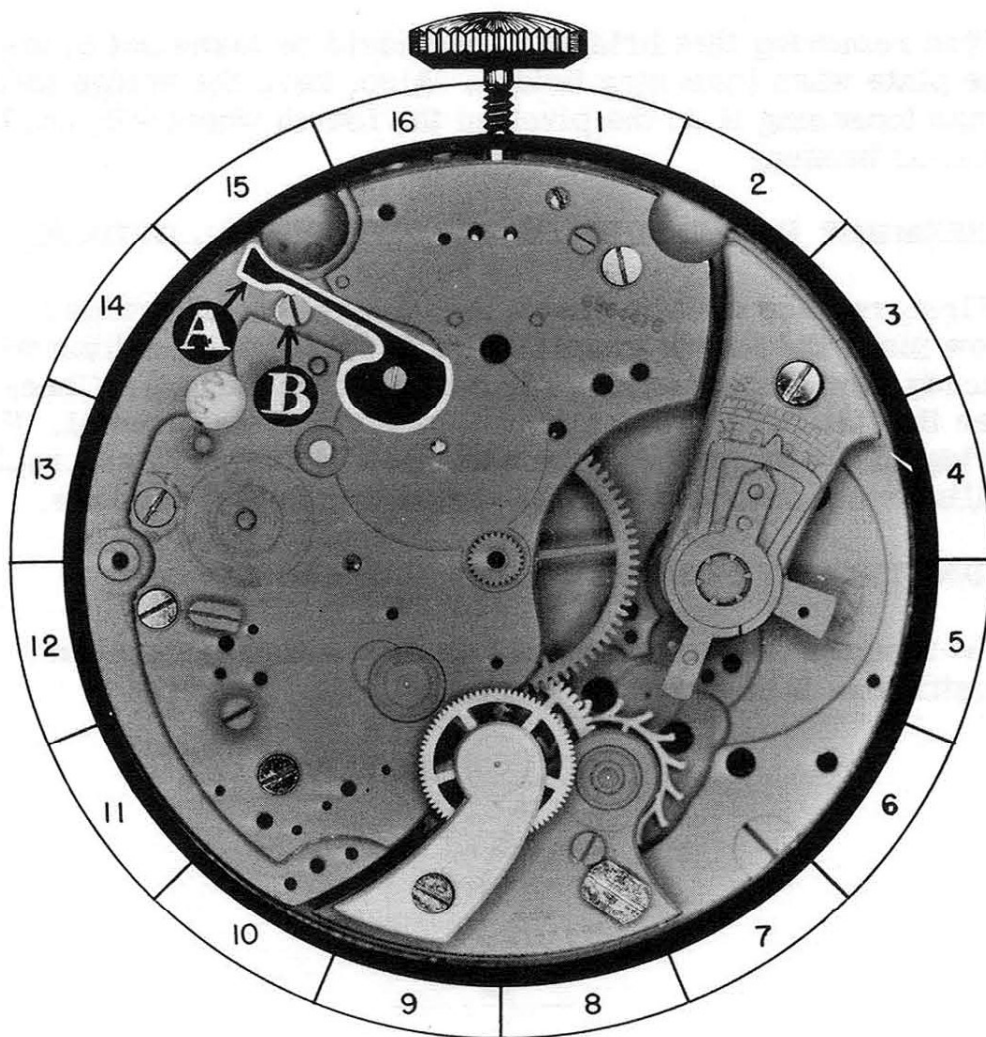

28-A

PART NO. 29

A. DISASSEMBLY PROCEDURE OF FOURTH WHEEL BRIDGE:

To remove this bridge, remove fillister head screw FS-4 and loosen bridge from the escape wheel bridge with a thin-blade screw-driver. When steady pins are free, the bridge can be lifted free from movement.

NOTICE

NOTICE

NOTICE

After the fourth wheel bridge is removed, remove the escape wheel bridge and the escape wheel.

(The shape of screw for this part is shown at bottom of page.)

B. HAZARDS IN DISASSEMBLY PROCEDURE OF FOURTH WHEEL BRIDGE:

When removing this bridge, care should be taken not to mar the plate when loosening bridge. Also, keep the bridge level when loosening it so the pivot on the fourth wheel will not be bent or broken.

C. ASSEMBLY PROCEDURE OF FOURTH WHEEL BRIDGE:

(First, replace escape wheel, then escape wheel bridge.)
Now place the fourth wheel bridge in its proper position with steady pins in proper holes in escape wheel bridge. Check to see that the fourth wheel pivot is entering hole in jewel. Press bridge down to proper place with back of tweezers and replace fillister head screw FS-4 that holds this bridge in place.

D. FUNCTION OF FOURTH WHEEL BRIDGE:

The function of this bridge is to hold the fourth wheel in position so it can function properly.

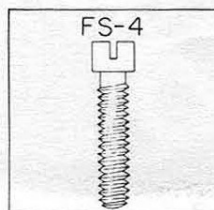

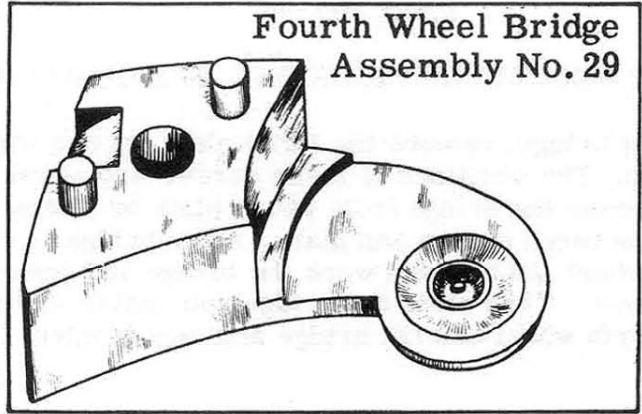

OILING

The pivot in the jewel in this bridge should be oiled as you usually oil a train pivot in a watch.

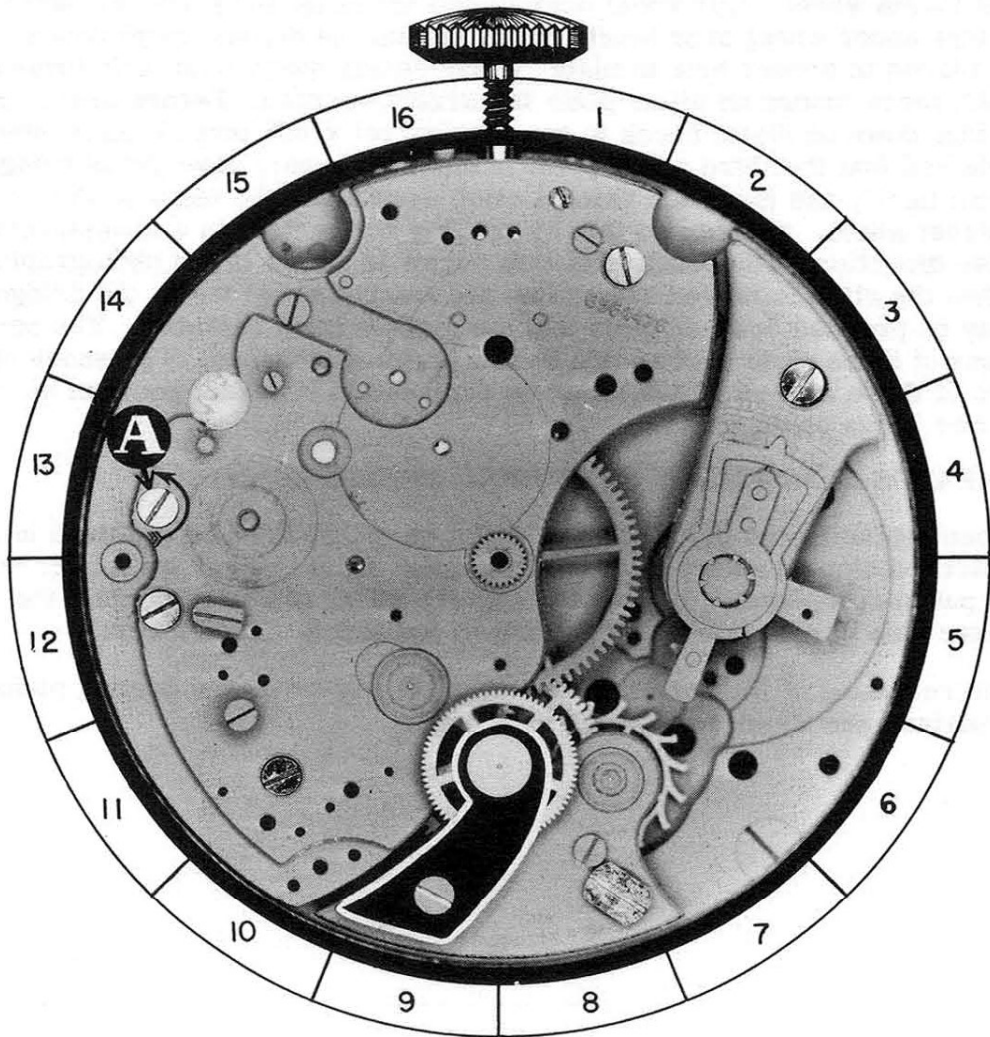

29-A

PART NO. 30

A. DISASSEMBLY PROCEDURE OF BARREL BRIDGE ASSEMBLY:

To remove this bridge, remove the three plate screws which hold this bridge in place. The positions of these screws are shown in the photograph. Now loosen the bridge from pillar plate by sliding a thin-blade screw-driver between bridge and plate. After bridge is free from plate, lift up fourth wheel slightly and work the bridge and center wheel post out of center hole. Then slide the bridge and center wheel from under wheel over fourth wheel and lift bridge and center wheel free from pillar plate.

(The shape of screws for this part are shown at bottom of page.)

B. HAZARDS IN DISASSEMBLY OF BARREL BRIDGE ASSEMBLY:

When removing this bridge, care must be taken not to damage the wheel over fourth wheel or fourth wheel.

C. ASSEMBLY PROCEDURE OF BARREL BRIDGE ASSEMBLY:

To replace the barrel bridge assembly, replace the barrel third wheel and fourth wheel. Lift wheel over fourth wheel up and work the barrel bridge under wheel over fourth wheel so that the center wheel post can be placed in proper hole in plate. After center wheel post is in proper hole, place bridge on pillar plate in correct position. Before pressing bridge down on plate, check to see that barrel arbor pivot is in proper hole and that the third wheel pivot is entering jewel. Now press bridge down lightly and move the ratchet click away from the teeth on the ratchet wheel. You can do this by turning screw "A" in a counter-clockwise direction. The position of this screw is shown in the photograph. When the click is moved away from the ratchet wheel teeth, the bridge may be pressed down on plate and the plate screws replaced. The positions of these plate screws are shown in the photograph. The shortest one of these screws, FS-5, must be replaced in its exact position as shown in the photograph.

D. HAZARDS IN ASSEMBLY OF BARREL BRIDGE ASSEMBLY:

When replacing the plate screws, make sure that FS-5 is replaced in its exact location as shown in the photograph. Should one of the longer screws be put in this place, it will go through the pillar plate and contact the under side of clutch lever, resulting in damage to clutch lever.

The removing of the center wheel from the intermediary driving pinion is explained and illustrated on the next page.

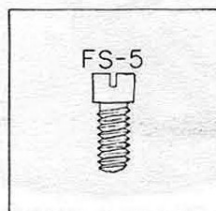

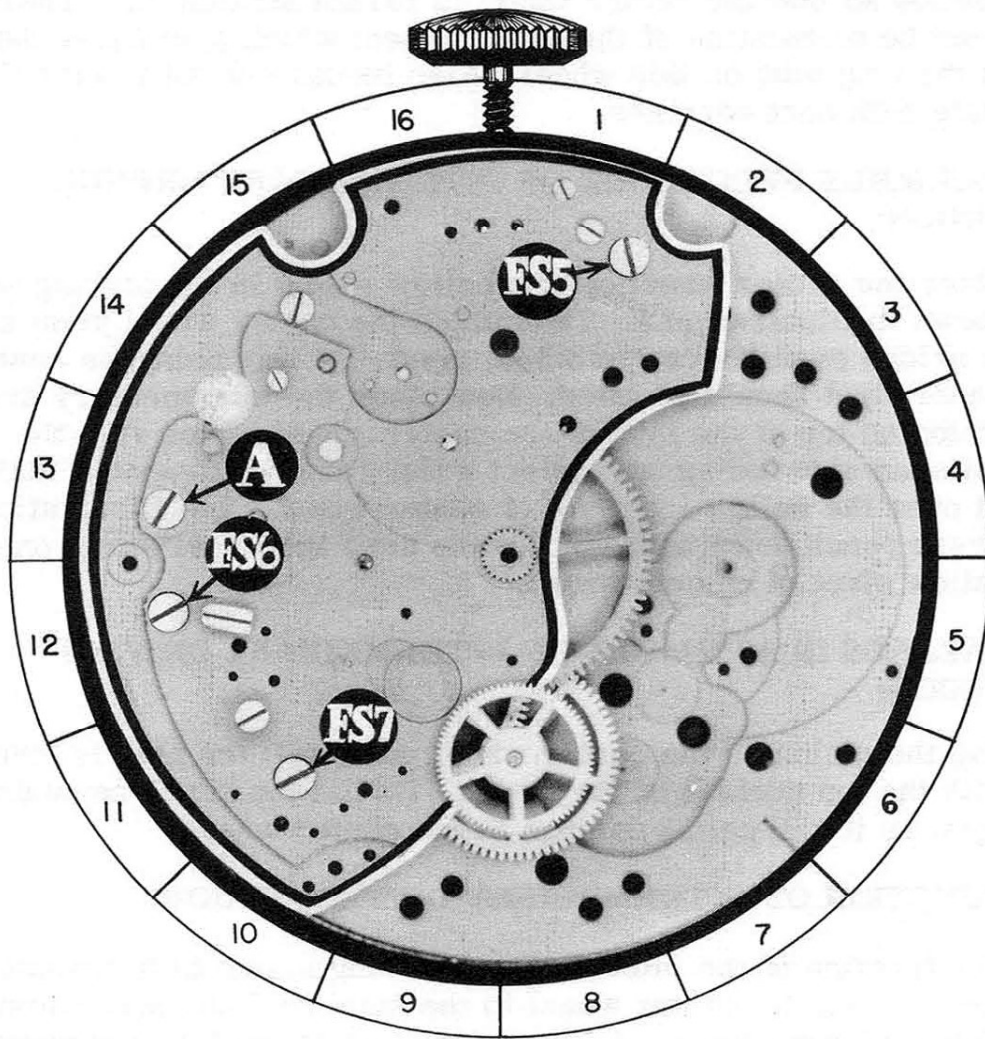
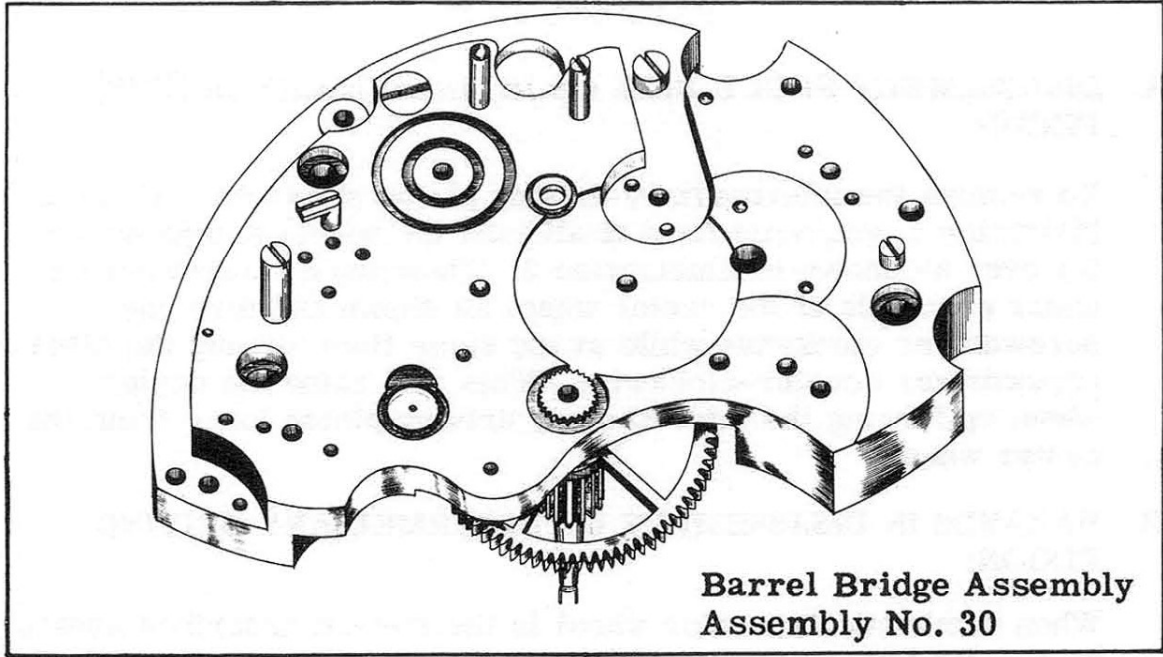

PART NO. 30-B

A. DISASSEMBLY PROCEDURE OF INTERMEDIARY DRIVING PINION:

To remove the intermediary driving pinion shown as "A" in Illustration 1, you must first of all turn the barrel bridge assembly over as shown in Illustration 2. Then place a screwdriver under each side of the center wheel as shown and turn one screwdriver clockwise while at the same time turning the other screwdriver counter-clockwise. This will raise the center wheel up forcing the intermediary driving pinion loose from the center wheel.

B. HAZARDS IN DISASSEMBLY OF INTERMEDIARY DRIVING PINION:

When removing the center wheel in the method described above, be careful to turn the screwdrivers the same amount in each direction so that the center wheel is raised straight up. There must be no twisting of the center wheel which may cause damage to the long tube on this wheel. Also be careful not to mar the plate with screwdrivers.

C. ASSEMBLY PROCEDURE OF INTERMEDIARY DRIVING PINION:

Place the center wheel over a hollow stump in the staking set as shown in Illustration 3. Then place the center wheel pivot hole in bridge over the center wheel pivot. At this point the center wheel pivot should be oiled. Now place the intermediary driving pinion on top of the tube of the center wheel pinion with the polished side facing up. Select a flat-face hollow punch that will fit over the hollow top pivot of center wheel. See Illustration 3. Press punch down with the fingers until the wheel snaps onto the hollow pivot of center wheel..

D. HAZARDS IN ASSEMBLY OF INTERMEDIARY DRIVING PINION:

Tap the pinion on the center wheel post until the post is level with the top surface of the pinion. Do not tap punch beyond this point as it will cause damage to the center wheel.

E. FUNCTION OF INTERMEDIARY DRIVING PINION:

The function of the intermediary driving pinion is to transfer the power from the center wheel to the hour register mechanism. This pinion continues to turn as long as the watch is running.

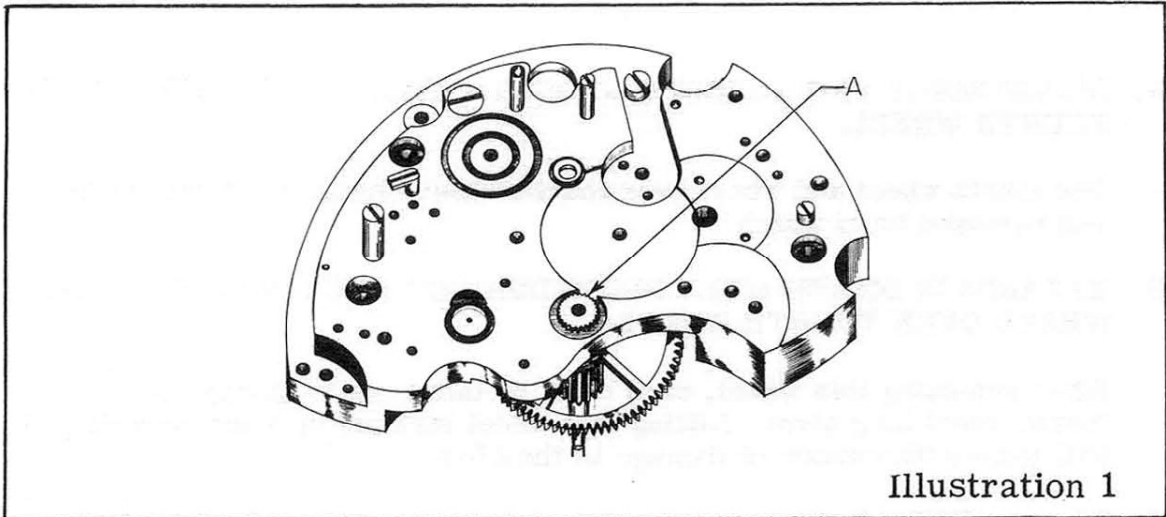

Illustration 1

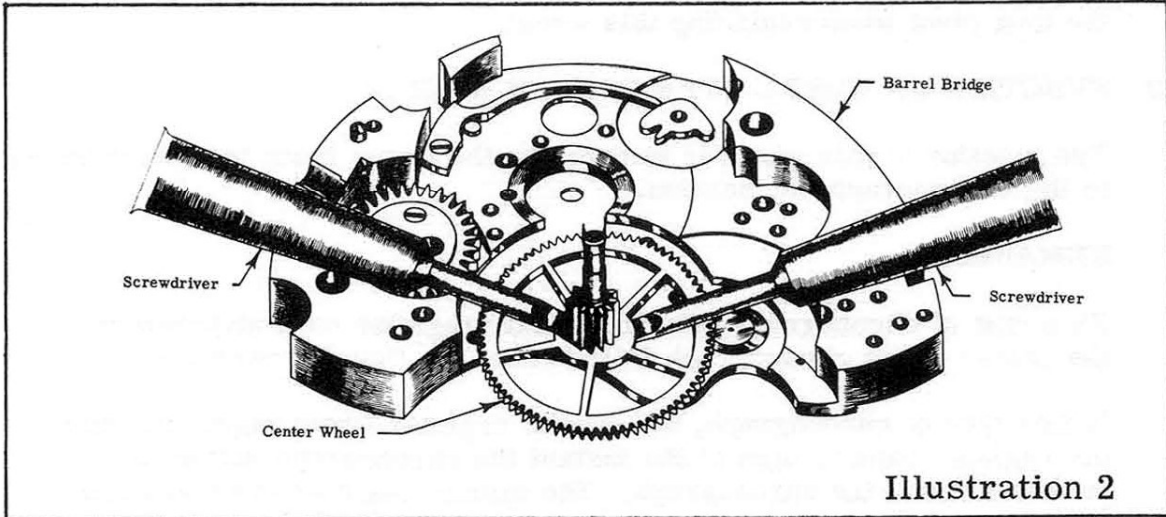

Illustration 2

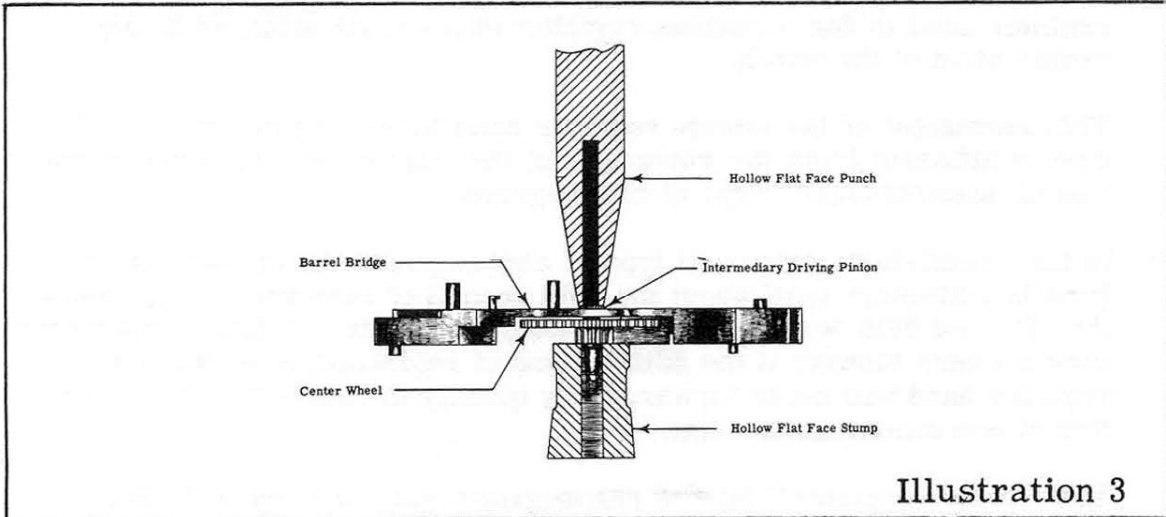

Illustration 3

Intermediary Driving Pinion

PART NO. 31

A. DISASSEMBLY PROCEDURE OF FOURTH WHEEL AND WHEEL OVER FOURTH WHEEL:

The fourth wheel and wheel over fourth wheel can be lifted out of place and removed from watch.

B. HAZARDS IN DISASSEMBLY PROCEDURE OF FOURTH WHEEL AND WHEEL OVER FOURTH WHEEL:

When removing this wheel, care must be taken not to damage the fourth wheel long pivot. Lifting this wheel straight up when removing it will lessen the chance of damage to the pivot.

C. When replacing fourth wheel and wheel over fourth wheel, place the long pivot "A" down in hole in jewel. Care must be taken not to bend the long pivot when replacing this wheel.

D. FUNCTION OF WHEEL OVER FOURTH WHEEL:

The function of this wheel is to transfer the power from the fourth wheel to the chronograph mechanism.

REMARKS:

This type of chronograph with the minute register hand attached to the center of the chronograph is known as the "center register".

In this type of chronograph, the minute register wheel starts the minute register hand to turn at the instant the chronograph button is pushed to start the chronograph. The minute register hand will continue to advance in a steady, even manner as long as the chronograph mechanism is in operation. This steady, even progress of the minute register hand is due to minute register wheel being attached to the center pivot of the watch.

This movement of the minute register hand in the "center register" type is different from the movement of the minute register hand in the "semi-instantaneous" type of chronograph.

In the "semi-instantaneous" type of chronograph, the minute register hand is stationary until about the 58th second of registration. Between the 58th and 60th second of registration, the minute register hand moves forward very slowly; at the 60th second of registration the minute register hand will move forward very quickly to complete the registration of one minute on the dial.

The "center register" type of chronograph was patented in 1889 and was more widely used 40 or 50 years ago than it is today. The semi-instantaneous type is by far the most popular type of chronograph in use today.

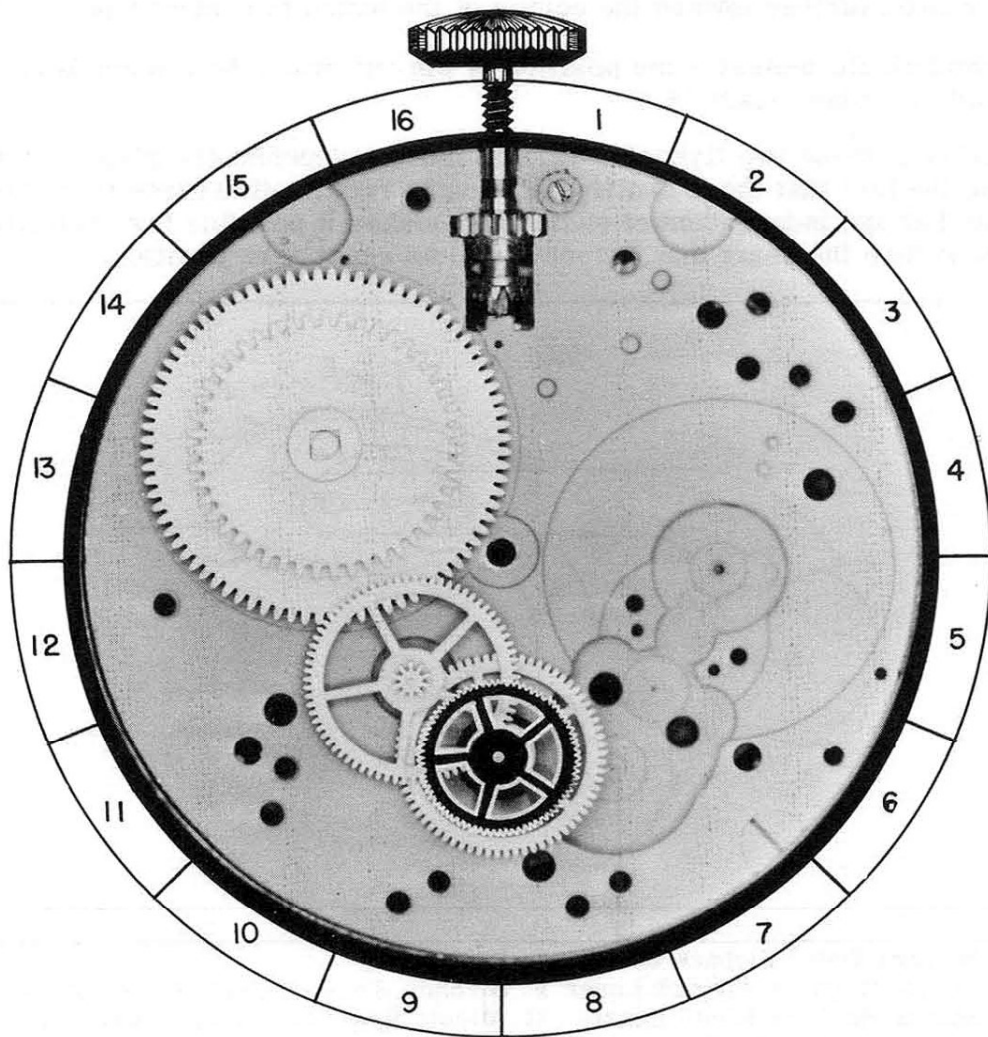
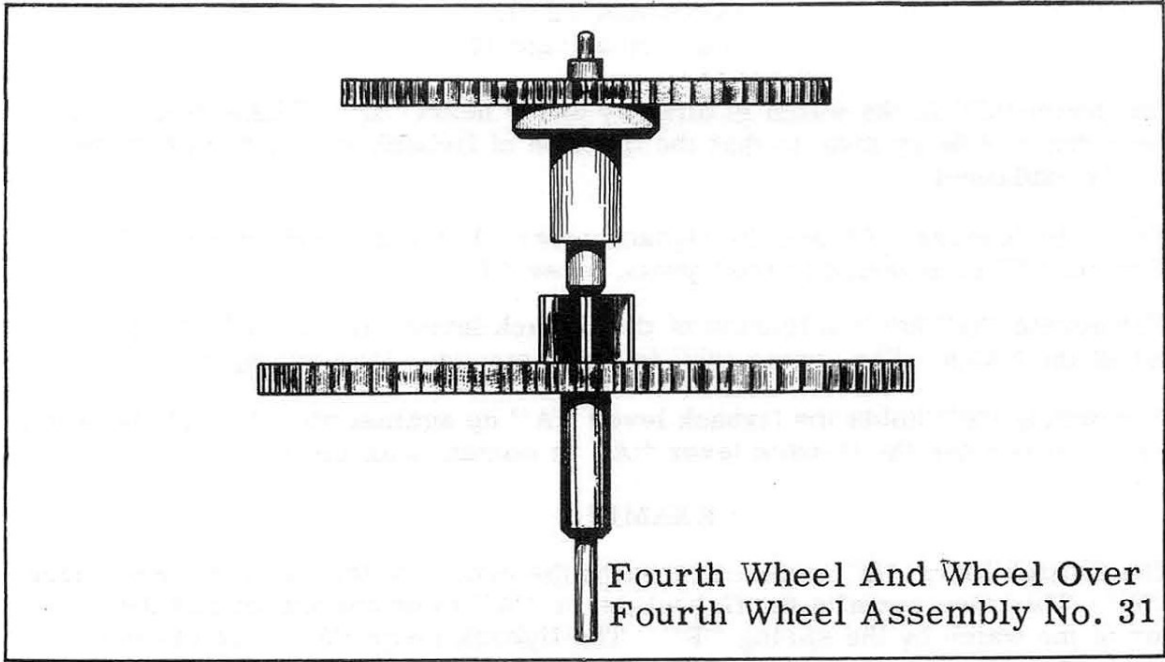

31-A

FLYBACK LEVER (Cont. from Page 12)

The heart "C" in the watch is directly under heart "D". These hearts have been drawn side by side so that the function of flyback levers can be more easily explained.

The flyback lever "A" and the flyback lever "B" both pivot on post "J". The pin "I" is attached to the flyback lever "B".

The spring "G" holds a tension of the flyback lever "B" away from the center of the watch. The spring "G" is much stronger than spring "F".

The spring "F" holds the flyback lever "A" up against pin "I". (At position "H" you can see the flyback lever "A" in contact with pin "I")

EXAMPLE

The flyback lever "B" is forced toward the center of the watch by push piece "E". This also permits the flyback lever "A" to be forced toward the center of the watch by the spring "F". The flyback lever "A" contacts the heart "D" first as shown in the illustration; the flyback lever "B" can be forced a little further toward the center of the watch to contact heart "C".

The dotted circle indicates the position of pin "I" when the flyback lever "B" is forced to contact heart "C".

The ability of these two flyback levers to move independently of each other and also the fact that these two flyback levers receive this force from two sources that are independent of each other makes it possible for each flyback lever to return the heart that it contacts to an exact zero position.

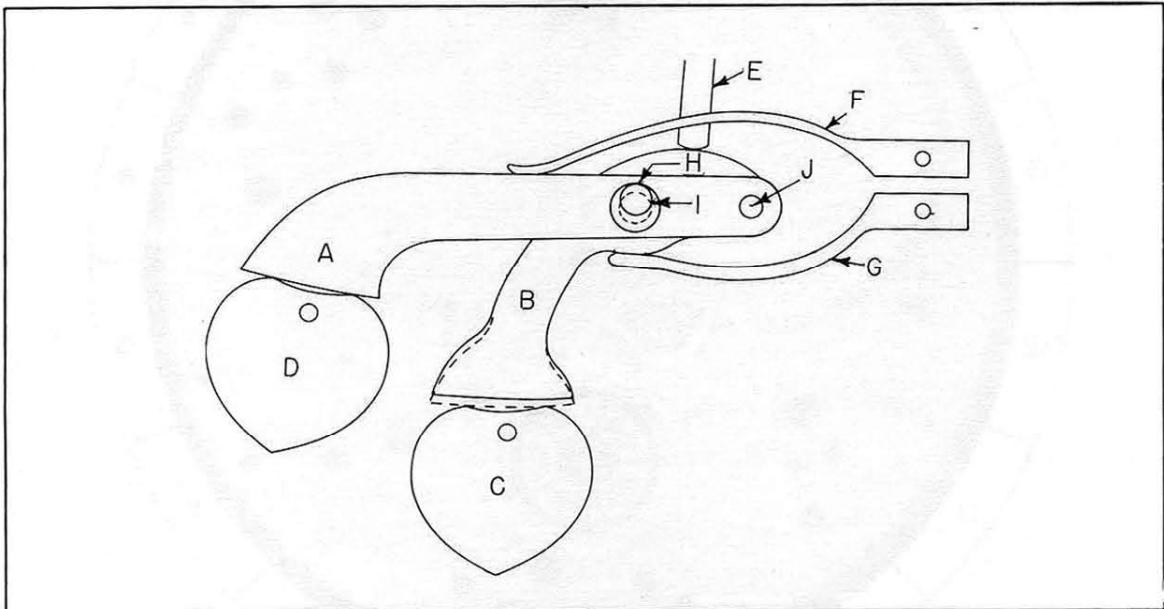

- | | |
|----------------------------------|---|
| A. Seconds Wheel Flyback Lever | E. Push Piece |
| B. Minute Register Flyback Lever | F. Seconds Wheel Flyback Lever Spring |
| C. Minute Register Wheel Heart | G. Minute Register Flyback Lever Spring |
| D. Seconds Wheel Heart | |

FUNCTIONAL RESULTS

After completely assembling the chronograph with the exception of back of case, place chronograph in front of you pendant up, movement side facing you.

1. Push button at left of pendant, hold in this position and check the following: (Make sure the castle wheel is in position so button can be pushed.)

- A. Check to see that seconds wheel and hour register wheel return the hands attached to these wheels to a zero position.

CORRECTION: The following errors could prevent these hands from returning to a zero position:

1. Loose hands or hands not set correctly.
2. Seconds wheel or hour register wheel binding and not pivoting freely.
3. The branches "A" and "B" of flyback lever not being of correct length to return one of these wheels to zero.

- B. Check to see that minute register wheel returns the hand attached to this wheel to zero.

CORRECTION: The following errors could prevent the minute register hand from returning to zero:

1. Minute register wheel binding and not pivoting freely.
2. Loose hand or hand not set correctly.
3. Flyback lever binding and not pivoting freely.

2. Release button and check the following:

- A. Check to see that flyback levers return to a neutral position.

CORRECTION: The following errors could prevent the flyback lever from returning to a neutral position:

1. Flyback levers binding and not pivoting freely on post.
2. Minute register flyback lever spring not holding enough tension on minute register flyback lever.

(Continued on next page)

FUNCTIONAL RESULTS
(Continued)

- B.** Check to see that hour register brake lever is in contact with hour register wheel.

CORRECTION: The following errors could prevent the hour register brake lever from contacting the hour register wheel:

1. Hour register brake lever not pivoting freely under shouldered screw.
2. Hour register brake lever spring not holding enough tension on hour register brake lever.

- C.** Check to see that seconds wheel brake lever is in contact with the seconds wheel.

CORRECTION: The following errors could prevent seconds wheel brake lever from contacting seconds wheel:

1. Seconds wheel brake lever not pivoting freely under head of shouldered screw.
2. Seconds wheel brake lever spring not holding enough tension on seconds wheel brake lever.

- D.** Check to see that minute register brake lever is in contact with minute register wheel.

CORRECTION: The following errors could prevent the minute register brake lever contacting minute register wheel:

1. Minute register brake lever binding and not pivoting freely under head of shouldered screw.
2. Minute register brake lever spring not holding enough tension on minute register brake lever.

- 3.** Push button at right of pendant, release it, and check the following:

- A.** Check depth of intermediary wheel teeth with seconds wheel teeth.

(Continued on next page)

FUNCTIONAL RESULTS
(Continued)

CORRECTION: The following errors could prevent proper depth-
of these wheels:

1. Chronograph pivoted detent binding and not pivoting freely.
2. Chronograph pivoted detent spring not holding enough tension on chronograph pivoted detent.
3. Improper adjustment of eccentric studs. (See adjustment of eccentric studs.)

B. Check on minute register wheel to see that it is turning:

CORRECTION: The following errors could prevent minute register wheel from turning:

1. Minute register wheel binding.
2. Center wheel hollow post fingers not holding enough tension on minute register wheel post.

C. Check to see that the seconds hand moves forward in a steady manner with no irregular jumping or jerking.

CORRECTION: The irregular movement of the second hand is usually caused by the seconds wheel tension spring not holding the proper tension on seconds wheel.

4. Push button at right of pendant a second time, release it, and check the following:

A. Check to see that the seconds wheel, minute register wheel, and hour register wheel brake levers are engaged with their respective wheels.

CORRECTION: The following errors could prevent these levers from engaging with their respective wheels:

1. Brake levers binding and not pivoting freely.
2. Brake lever springs not holding enough tension on brake levers.

B. Check to see that intermediary wheel is disengaged from seconds wheel.

CORRECTION: The following error could prevent intermediary wheel from disengaging with seconds wheel.

1. Improper adjustment of eccentric studs. (See adjustment of eccentric studs.)

DIRECTIONS FOR READING A CHRONOGRAPH DIAL

SECOND HAND

- A. The second hand indicates the passing of seconds and should move one space each second. One complete revolution of hand denotes passage of one minute. This hand is independent of chronograph mechanism and continues to register the seconds as long as watch is running.

SPLIT SECOND SCALE

- B. This scale is divided into 300 divisions, each indicating $\frac{1}{5}$ of a second. Every fifth division is marked with extra long lines denoting one second.

The main purpose of this scale is to measure a fraction of a second accurately.

MINUTE REGISTER

- C. The minute register hand indicates on the dial the number of minutes that have elapsed since the beginning of the registration of the sweep second hand. One complete revolution of the minute register hand indicates the passage of 30 minutes; two revolutions, one hour.

HOURLY REGISTER

- D. The hour register hand indicates on the dial the number of hours that have elapsed since the beginning of the registration of the sweep second hand. Each division on scale denotes $\frac{1}{2}$ hour. Each number on scale denotes one hour. One complete revolution of hour register hand indicates 12 hours have elapsed. This hand will register the hours as long as the chronograph mechanism is in operation.

THE CHRONOGRAPH DIAL

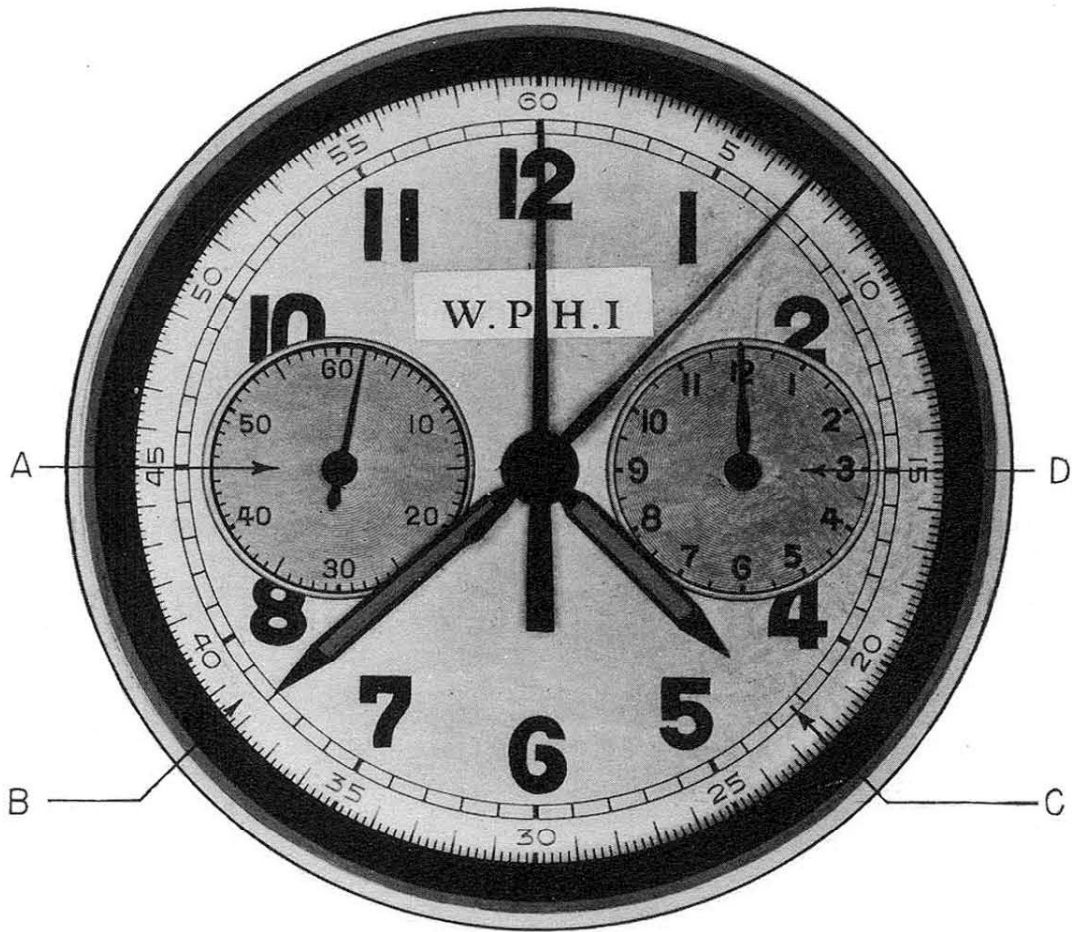

SETTING THE HANDS CORRECTLY ON A CHRONOGRAPH

After the chronograph is completely assembled and in working condition, replace the hour hand, minute hand, and second hand as you would on a regular watch. At this point, do not replace the minute register hand or the sweep second hand. Now push the button and bring the flyback lever in toward the center of the watch. While holding the flyback lever in toward the center of the watch, place the minute register hand at 60 on the minute register scale "C". Place the sweep second hand at 60 on the split second scale "B", and the hour register hand at 12 on the hour register scale "D". After these hands are replaced, start the chronograph mechanism with the sweep second hand turning and let chronograph mechanism run for at least one half hour. Now push the button to bring the flyback lever in toward the center of the watch, and check to see that the minute register and sweep second and the hour register hands all return to their original position.