

WORLD'S ONLY  
FULLY ILLUSTRATED  
**CHRONOGRAPH WATCH COURSE**  
VOLUME 23

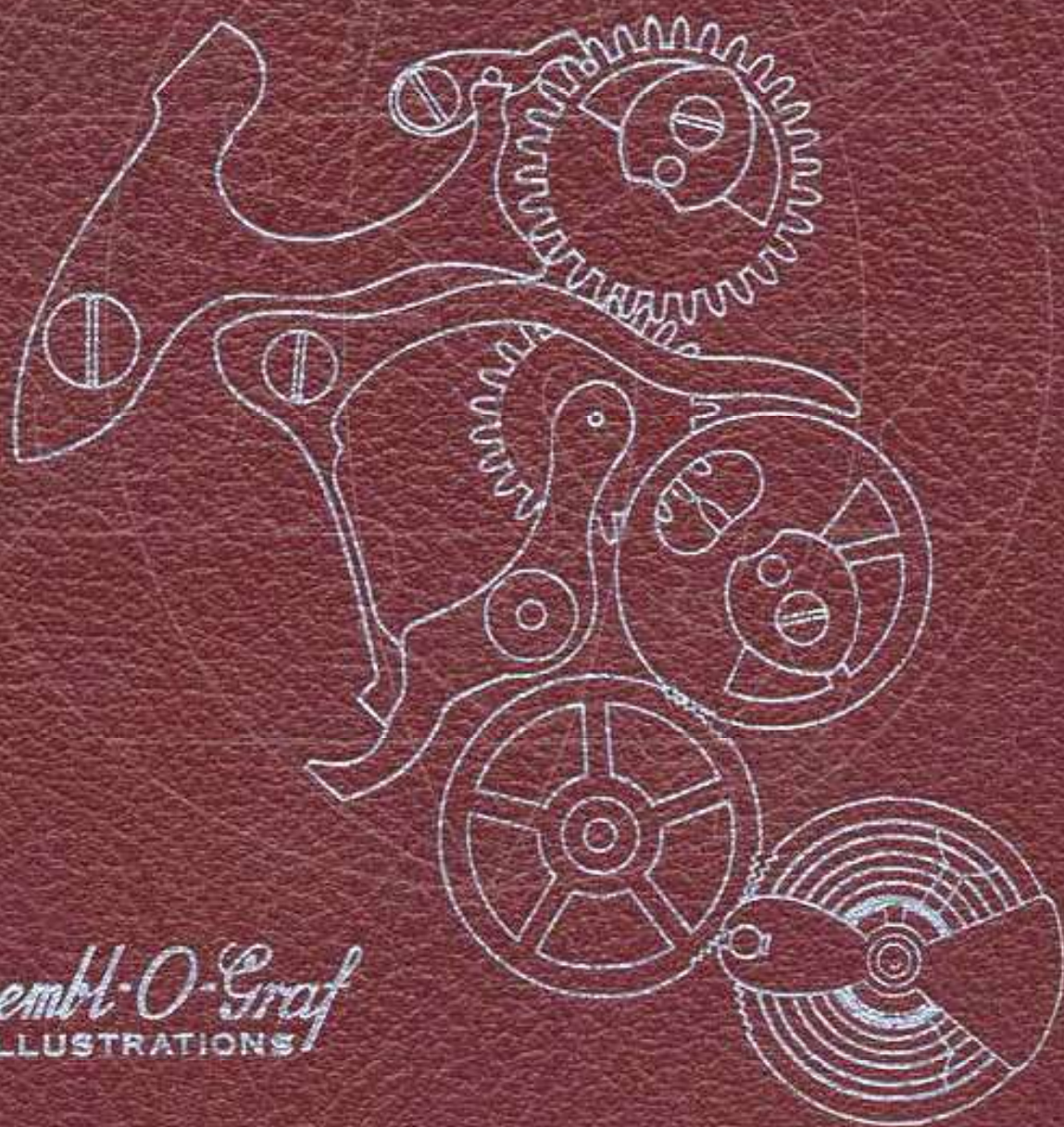

*Essemb-O-Graf*  
ILLUSTRATIONS

# IDENTIFICATION OF CHRONOGRAPH



14L



VENUS  
CAL. 179  
CAL. 185



# ESEMBL-O-GRAF

THE WORLD'S FIRST FULLY  
ILLUSTRATED TEXT BOOK  
ON  
CHRONOGRAPH REPAIRING  
AND ADJUSTING



BY

**William O. Smith, Sr.**

PRESIDENT AND TECHNICAL DIRECTOR

AND

**William O. Smith, Jr.**

CHIEF ENGINEER, RESEARCH LABORATORIES

WESTERN PENNSYLVANIA HOROLOGICAL INSTITUTE, INC.  
PITTSBURGH, PENNSYLVANIA

## INSTRUCTIONS

For use of book

### DISASSEMBLY OF THE CHRONOGRAPH MECHANISM:

1. Study the isometric drawing at top of page 1-A. The isometric drawing was made for the following purposes:

- A. It helps to identify the part to be removed.
- B. This drawing aids in pointing out certain locations on the part that are mentioned in the oiling procedure.
- C. The text refers to certain points on the part. These points are shown in the isometric drawing. This should aid you in finding the exact location on the part that is described in the text.
- D. It helps you to determine the shape of the part in case a new part has to be made.
- E. When disassembling the chronograph, each part should be carefully examined as it is removed from the movement. Each part should be checked against the isometric drawings to see that the part is the correct shape and is not broken. Each part should also be checked for any pits of rust, roughness, or burrs and for worn parts which may cause the part not to work properly.

2. At the bottom of the page 1-A is a photograph of a chronograph. In this photograph is the same part painted in black. The part is in the exact location that this part occupies in the watch. Find this location in the watch.

3. Read the disassembly procedure and the hazards in disassembly on page 1 in this book.

4. Remove this part in the same procedure as described in the text.

5. A very important item in disassembling a chronograph is keeping the screws in order, much time will be lost in putting the chronograph together if screws are mixed up. This means you have to hunt for each screw, sometimes trying three or four screws before finding the correct one. It cannot be stressed too strongly that care should be taken so that screws are not mixed up. The system that we advise for beginners, is to replace each individual screw after each part is removed. This naturally eliminates the hazard of mixing up the screws and will save you much time in the end. Do this at least until you become so thoroughly familiar with the chronograph that you no longer feel it is necessary.

6. Continue to follow this procedure throughout the book, and disassemble each part until the last part of the chronograph is removed.

### ASSEMBLY OF THE CHRONOGRAPH MECHANISM:

7. When you are ready to assemble the chronograph mechanism, study the isometric drawing on the last part in this book. This drawing should aid you in identifying the part to be assembled and detecting possible defects on the part.

8. At the bottom of this page is a photograph of a chronograph. In this photograph is the same part painted in black. The part is shown in the exact location it occupies in the watch. (Continued on next page)

## INSTRUCTIONS (Continued)

9. After you find the correct location for this part in the watch, read the oiling procedure for this part. The oiling procedure for this part is located underneath the isometric drawing. It is best to read the oiling procedure before you put each part in place, as there are certain parts that must be oiled immediately, as it may prove difficult to oil them later.

10. Read the assembly procedure and the hazards in assembling for the last part in this book.

11. Replace the part in its exact location, as shown in photograph, using the procedure as described in the text.

12. Replace the screw that holds this part in place. Of course, the screws should be kept in order as we advised above, but if the screws are not in order or the watch was received with screws mixed up, you will find a screw drawn for each part that requires a screw, at the bottom of the text page.

13. After replacing this part, replace the next part, etc., until the last part is replaced, which will be part No. 1. For replacing each part, use the procedure as described in the text.

(Note: the assembly of the chronograph is exactly the reverse of the disassembly.)

14. After the chronograph mechanism is assembled, read the functions of the different parts in the mechanism. This should help you to understand more fully the purpose of each part and how it works in conjunction with the other parts. It is to your advantage also to read the function before assembling each part, as many mistakes can be prevented when the assembling is done with an understanding of the function.

15. Now put movement in its case, and replace dial and hands. If the movement is put in the case from the back side, the dial and the hands must be replaced first. (For information on setting the hands correctly on a chronograph, refer to page 55.)

16. Read the text on adjustment of eccentric studs. This text should be read with reference to the eccentric stud picture. Now adjust each eccentric stud, one at a time, in the watch, as described in the text. Use the picture to find the position of these studs.







17. Study the text on functional results in this book, and check the chronograph mechanism as described in this text.

### NOMENCLATURE OF PARTS FOR CHRONOGRAPH MECHANISM

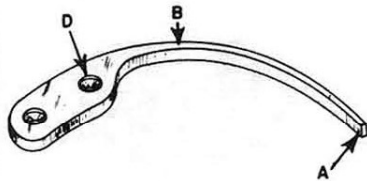
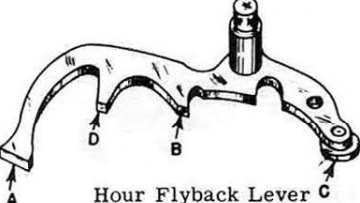
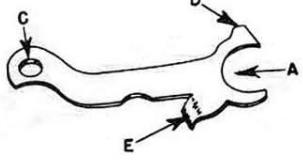
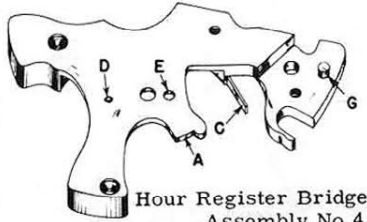
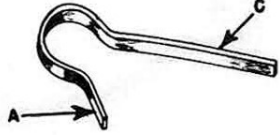
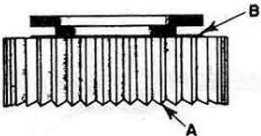
18. After you have become thoroughly familiar with the chronograph mechanism you can disassemble and assemble the chronograph by using the nomenclature of parts as a guide. This makes it possible for you to use a procedure without going through each page in the book.

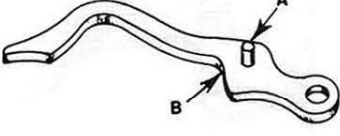

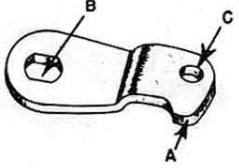
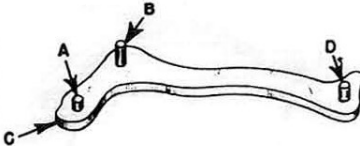
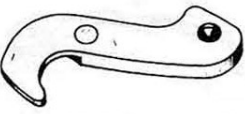
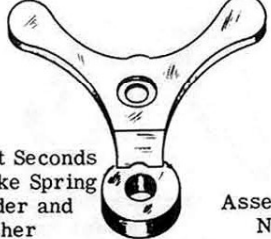
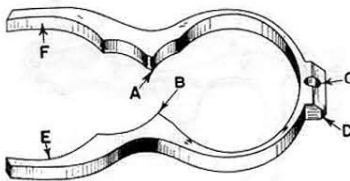
19. On each page in this book, the part number and the page number are the same. This makes it convenient for the reader and eliminates any confusion.

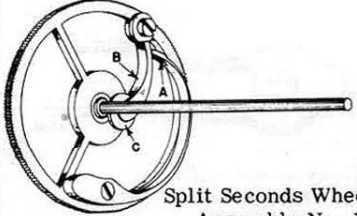
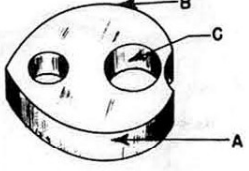
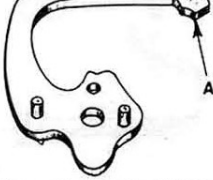
# NOMENCLATURE OF PARTS FOR CHRONOGRAPH MECHANISM

 <p>Hour Flyback Lever Spring Assembly No. 1</p>	 <p>Hour Flyback Lever Assembly No. 2</p>	 <p>Hour Clutch Spring Assembly No. 3</p>
 <p>Hour Register Bridge Assembly No. 4</p>	 <p>Hour Brake Lever Spring Assembly No. 4-B</p>	 <p>Hour Clutch Assembly No. 5</p>
 <p>Assembly No. 6 Hour Register Wheel</p>	 <p>Hour Brake Lever Assembly No. 7</p>	 <p>Hour Driving Lever Spring Assembly No. 8</p>
 <p>Hour Detent Lever Assembly No. 9</p>	 <p>Hour Driving Lever Assembly No. 10</p>	 <p>Hour Hook Bridge Assembly No. 11</p>
 <p>Split Seconds Brake Spring Holder and Washer Assembly No. 12</p>	 <p>Split Seconds Brake Spring Assembly No. 13</p>	 <p>Split Seconds Wheel Bridge Assembly No. 14</p>
 <p>Split Seconds Wheel Assembly No. 15</p>	 <p>Split Seconds Heart Assembly No. 16</p>	 <p>Split Seconds Castle Wheel Pawl Assembly No. 17</p>

Continued on next page

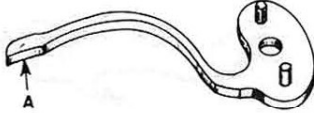
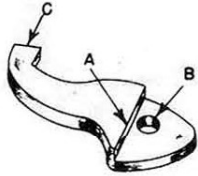
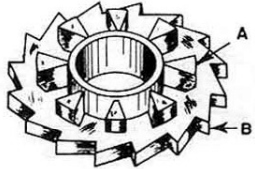

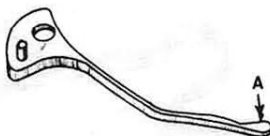
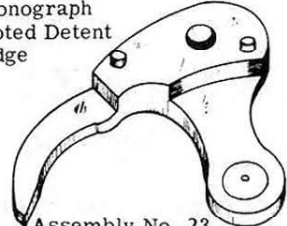
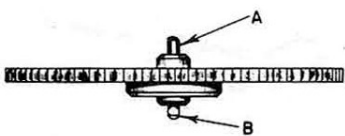
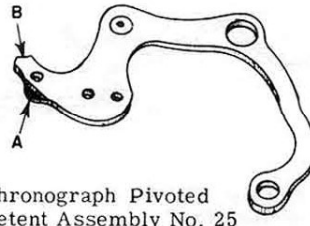
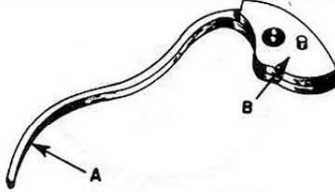
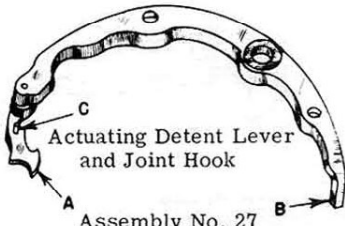
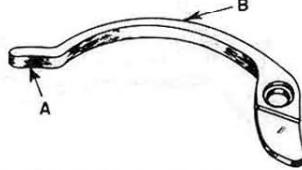
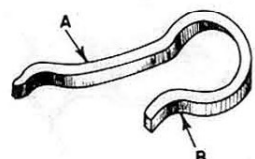
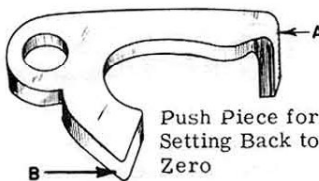
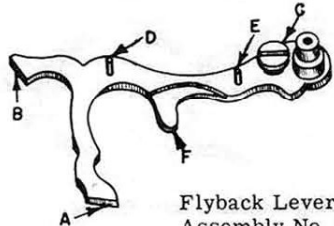
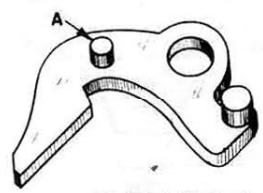
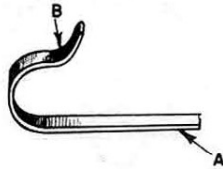
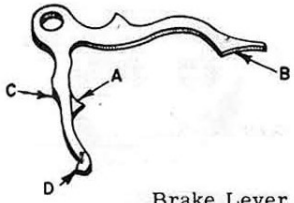
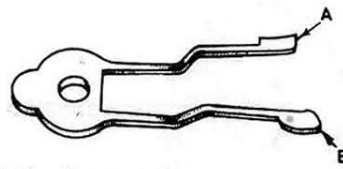
# NOMENCLATURE OF PARTS FOR CHRONOGRAPH MECHANISM

 <p>Split Seconds Joint Hook Spring Assembly No. 18</p>	 <p>Split Seconds Joint Hook Assembly No. 19</p>	 <p>Split Seconds Castle Wheel Assembly No. 20</p>
 <p>Wheel Over Fourth Wheel Assembly No. 21</p>	 <p>Chronograph Pivoted Detent Spring Assembly No. 22</p>	 <p>Chronograph Pivoted Detent Bridge Assembly No. 23</p>
 <p>Intermediary Wheel Assembly No. 24</p>	 <p>Chronograph Pivoted Detent Assembly No. 25</p>	 <p>Actuating Detent Lever Spring Assembly No. 26</p>
 <p>Actuating Detent Lever and Joint Hook Assembly No. 27</p>	 <p>Flyback Lever Spring Assembly No. 28</p>	 <p>Push Piece for Setting Back to Zero Spring Assembly No. 29</p>
 <p>Push Piece for Setting Back to Zero Assembly No. 30</p>	 <p>Flyback Lever Assembly No. 31</p>	 <p>Flyback Trip Lever Assembly No. 32</p>
 <p>Flyback Trip Lever Spring Assembly No. 33</p>	 <p>Brake Lever Assembly No. 34</p>	 <p>Brake Lever and Intermittent Lever Spring Assembly No. 35</p>

Continued on next page

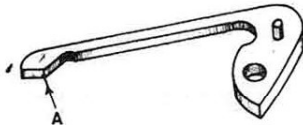
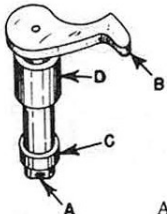
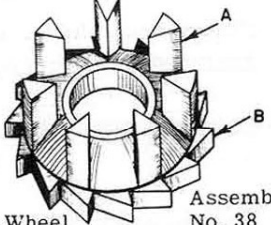
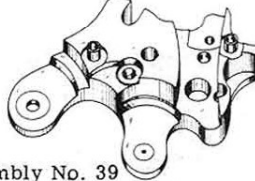
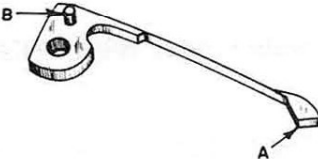
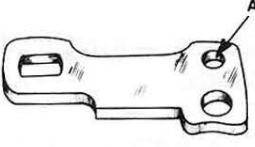
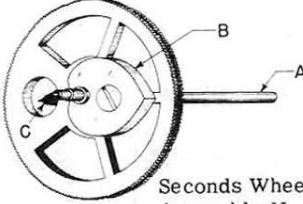
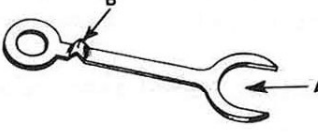
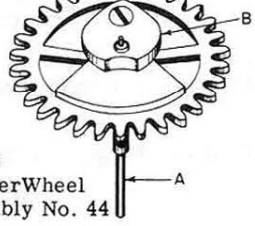
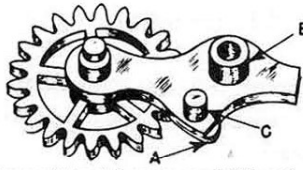
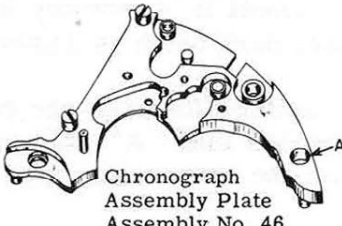
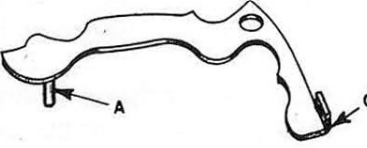
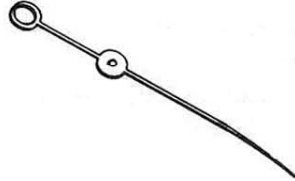
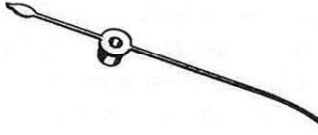

# NOMENCLATURE OF PARTS FOR CHRONOGRAPH MECHANISM

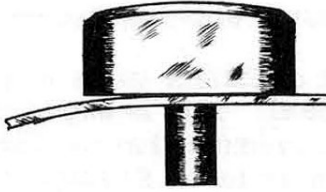
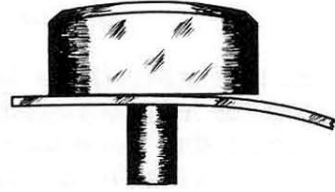
 <p style="text-align: center;">Castle Wheel Pawl Assembly No. 36</p>	 <p style="text-align: center;">Hour Register Switch Lever Assembly No. 37</p>	 <p style="text-align: center;">Castle Wheel Assembly No. 38</p>
 <p style="text-align: center;">Assembly No. 39 Seconds Wheel and Minute Register Wheel Bridge</p>	 <p style="text-align: center;">Minute Register Pawl Assembly No. 40</p>	 <p style="text-align: center;">Minute Register Pawl Adjustment Plate Assembly No. 41</p>
 <p style="text-align: center;">Seconds Wheel Assembly No. 42</p>	 <p style="text-align: center;">Seconds Wheel Tension Spring Assembly No. 43</p>	 <p style="text-align: center;">Minute Register Wheel Assembly No. 44</p>
 <p style="text-align: center;">Intermittent Lever and Wheel Assembly Assembly No. 45</p>	 <p style="text-align: center;">Chronograph Assembly Plate Assembly No. 46</p>	 <p style="text-align: center;">Split Seconds Actuating Detent Lever Assembly No. 47</p>
 <p style="text-align: center;">Split Second Hand</p>	 <p style="text-align: center;">Sweep Second Hand</p>	 <p style="text-align: center;">Minute Register Hand</p>
 <p style="text-align: center;">Hour Register Hand</p>	 <p style="text-align: center;">Chronograph Button</p>	 <p style="text-align: center;">Chronograph Button</p>

## ADJUSTING ECCENTRIC STUDS - THINGS TO CHECK

Listed below are a number of depthings and adjustments controlled by the eccentric studs:

1. Check the depthing of the wheel over fourth wheel teeth with the intermediary wheel teeth.

Correction: If this depthing is incorrect, it can be corrected by adjusting eccentric stud ES-1.

Reference: Wheel over fourth wheel is Assembly 21.  
Intermediary wheel is Assembly 24.

2. Check depthing of the seconds wheel teeth with the intermediary wheel teeth.

Correction: If this depthing is incorrect, it can be corrected by adjusting eccentric stud ES-2.

Reference: Seconds wheel is Assembly 42.  
Intermediary wheel is Assembly 24.

3. Check depthing of intermittent wheel teeth with seconds wheel dart tooth.

Correction: If this depthing is incorrect, it can be corrected by adjusting eccentric stud ES-3.

Reference: Intermittent wheel is Assembly 45.  
Seconds wheel dart tooth is Assembly 42, location "C".

4. When the flyback lever is forced towards the center of watch and held in this position, check to see that end "A" of minute register pawl is centered between two teeth on the minute register wheel.

Correction: If the minute register pawl is not centered between two teeth on the minute register wheel, this can be corrected by loosening shouldered screw SS-11 on Page 41, and adjusting the pawl until end "A" of pawl is centered between two teeth on this wheel. After pawl is adjusted, tighten shouldered screw SS-11 that holds this part in correct position.

Reference: Flyback lever is Assembly 31.  
Minute register pawl is Assembly 40.  
Minute register wheel is Assembly 44.

At this place, there is not sufficient space to go into the details in adjusting the minute register pawl. This is one of the most important adjustments that must be made in order that the chronograph functions properly. It is advisable that you refer to the Esembl-O-Graf Function Book for more detailed information with complete illustrations.

# ADJUSTING ECCENTRIC STUDS

DO NOT REMOVE THESE STUDS

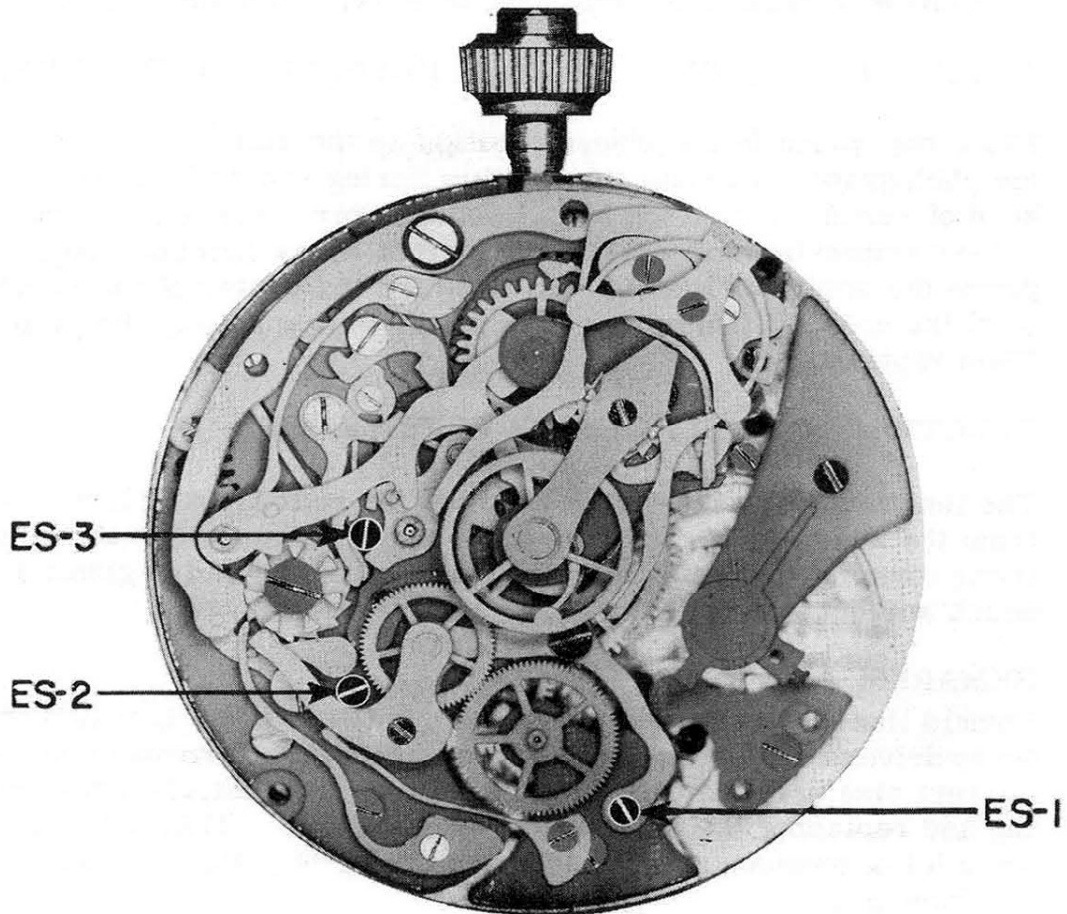

## CAUTION

In disassembling or assembling a chronograph, it is a good policy not to turn eccentric studs. These eccentric studs are used to adjust one part to another, and naturally, in turning these studs, you will lose the desired adjustment of the chronograph mechanism, which will cause the chronograph to function incorrectly. Another reason for not turning these studs unless it is necessary, is that they soon become loose, and will not hold the desired adjustment.

**A. DISASSEMBLY PROCEDURE OF HOUR FLYBACK LEVER SPRING:**

The hour flyback lever spring is held in place by two identical, beveled countersink screws, BS-1 and BS-2. First, remove screw BS-1; this will release the tension on the spring; now remove screw BS-2 and then lift the spring out of place. The positions of these screws are shown on the photograph.

(The shape of screws for this part is shown at bottom of page).

**B. ASSEMBLY PROCEDURE OF HOUR FLYBACK LEVER SPRING:**

Place the spring in its proper position on the plate, as shown on the photograph. The end "A" of this spring should fit under the head of screw "C" on the hour flyback lever. Now replace beveled countersink screw BS-2. After this screw has been replaced, press the spring at location "B" toward the center of the watch until the hole "D" in spring is over the screw hole in the plate. Then replace screw BS-1.

**C. FUNCTION OF HOUR FLYBACK LEVER SPRING:**

The function of this spring is to force the hour flyback lever away from the heart on the hour register wheel. Thus, when the registration begins, the hour register wheel can turn and register the hours without interference of the hour flyback lever.

**REMARKS:**

I would like to remind the repairman, that it is important that the screwdrivers and tweezers should be properly sharpened and the correct size screw driver blade used for each slot, when removing and replacing the parts in the chronograph. This will eliminate a lot of unnecessary breakage, marring of plates, or screws and loss of parts.

**REFERENCE:** Hour flyback lever is Assembly 2.  
Hour register wheel is Assembly 6.

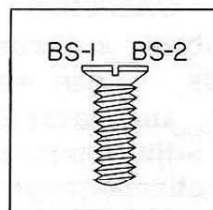

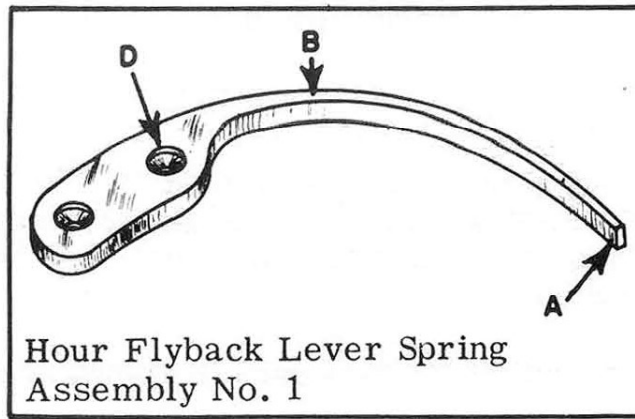

Hour Flyback Lever Spring  
Assembly No. 1

### OILING

End "A" of hour flyback lever spring should be slightly moistened with oil at point of contact with hour flyback lever.

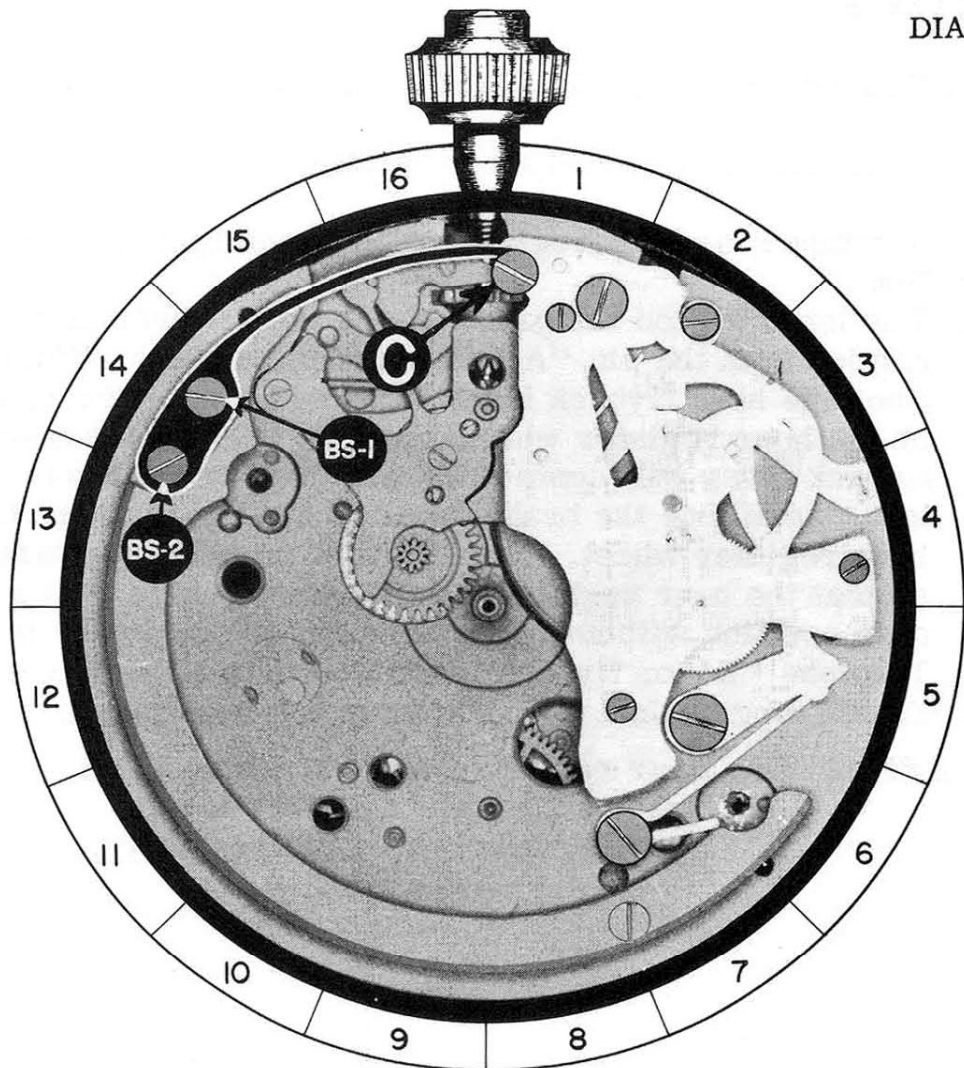

DIAL SIDE

1-A

**A. DISASSEMBLY PROCEDURE OF HOUR FLYBACK LEVER:**

The hour flyback lever pivots on post "G" of hour register bridge, and is held in place by shouldered screw SS-1. After this screw has been removed, the lever may be lifted from post "G" and out of place.

(The shape of screw for this part is shown at bottom of page).

**B. ASSEMBLY PROCEDURE OF HOUR FLYBACK LEVER:**

Place the hour flyback lever in its proper position, as shown on the photograph, with the hole in lever over the post "G" on hour register bridge. Now replace shouldered screw SS-1. Check to see that lever can move freely under head of screw SS-1.

**C. FUNCTION OF HOUR FLYBACK LEVER:**

The functions of this lever are as follows:

1. It returns the hour register wheel back to a zero position.
2. The lobe "B" on the hour flyback lever works in connection with the pin "A" on hour brake lever. Thus, when the hour flyback lever is forced toward the heart on the hour register wheel, the lobe "B" on the hour flyback lever will contact the pin "A" on the brake lever, and force the brake lever to disengage from the hour register wheel. This function must be performed so that the hour register wheel can be returned to a zero position without interference from the brake lever.
3. The lobe "D" on flyback lever prevents flyback lever from being pushed when chronograph is engaged.

REFERENCE: Hour register bridge is Assembly 4.  
Hour brake lever is Assembly 7.  
Hour register wheel is Assembly 6.

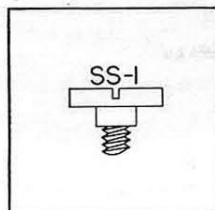

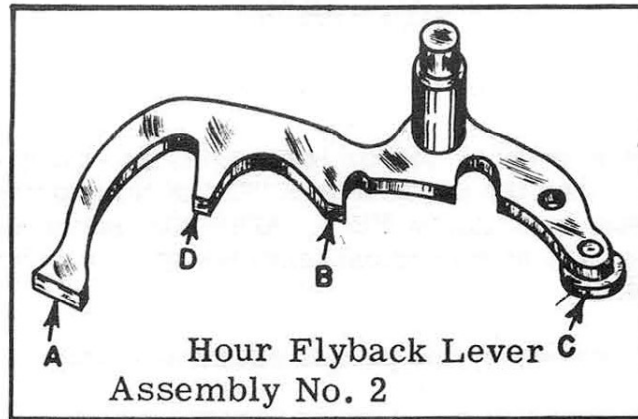

### OILING

The hour flyback lever should be slightly moistened with oil at these points:

1. Post "G" on hour register bridge on which flyback lever pivots.
2. Surface of flyback lever that moves under head of screw SS-1.

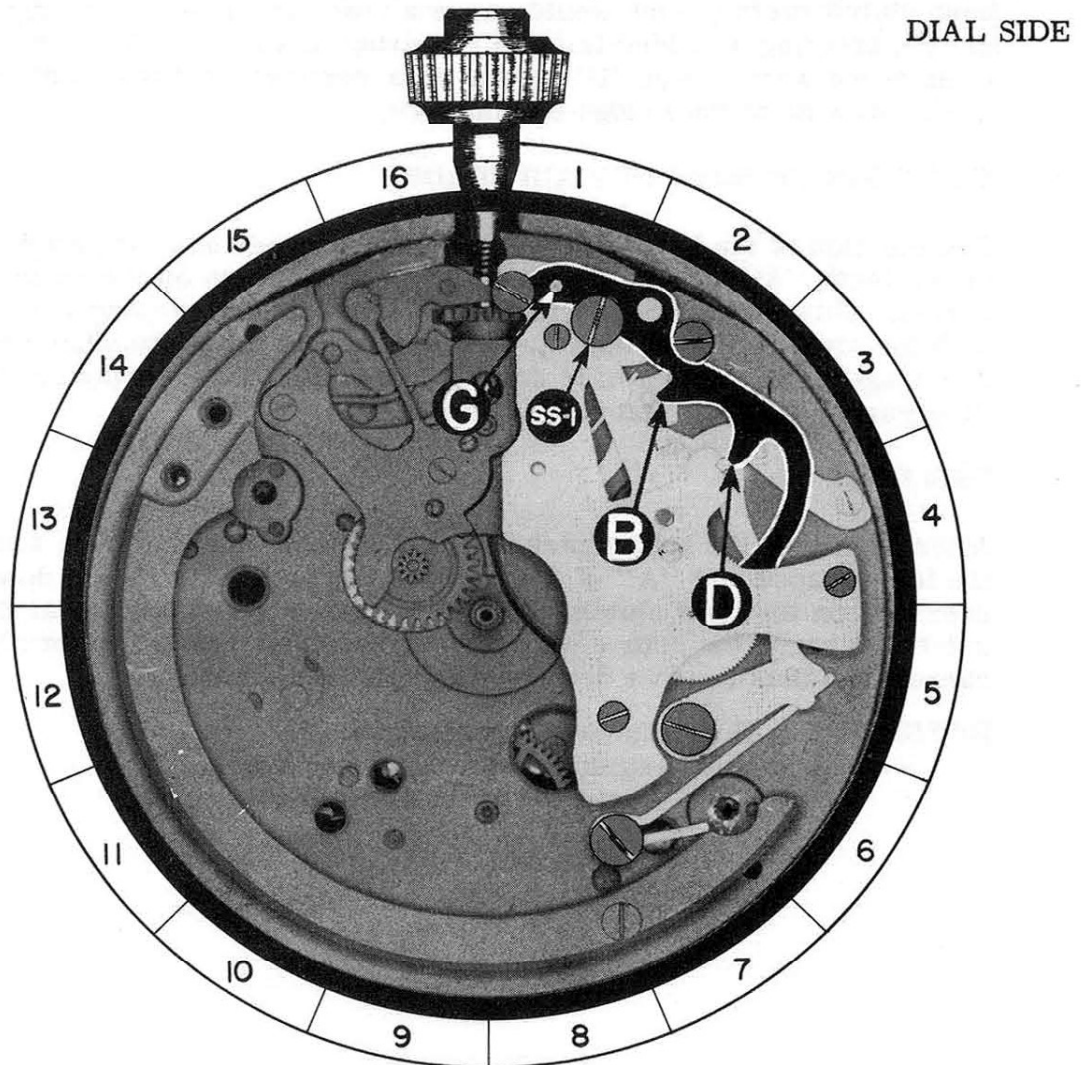

2-A

**A. DISASSEMBLY PROCEDURE OF HOUR CLUTCH SPRING:**

The fork-shaped end "A" of this spring fits into the groove "B" on the hour clutch, and the opposite end "C" of this spring is held in place by fillister head screw FS-1. After this screw has been removed, the spring may be moved out from the groove in hour clutch and lifted out of place.

(The shape of screw for this part is shown at bottom of page.)

**B. ASSEMBLY PROCEDURE OF HOUR CLUTCH SPRING:**

Slide the fork-shaped end "A" of this spring into the groove "B" on the hour clutch, and place the hole in end "C" of spring over screw hole in hour register bridge. Now, replace fillister head screw FS-1 that holds this part in place. The surface "D" on the hour clutch spring will contact the pin "B" on the hour register bridge when tightening fillister head screw FS-1. This prevents any shifting of the hour clutch spring, which would cause a sideward pressure on the hour clutch, creating an added friction resulting in a loss of power in the train of the watch. Pin "B" on the hour register bridge is indicated in the drawing of the bridge on Page 4-C.

**C. FUNCTION OF HOUR CLUTCH SPRING:**

The function of the hour clutch spring is to engage and disengage the crown teeth "A" of hour clutch with the crown teeth on the main spring barrel. This spring holds a tension on hour clutch, keeping it in mesh with the crown teeth on barrel. When the chronograph mechanism is disengaged, pin "A" on hour driving lever forces the spring up, thus disengaging the hour clutch from the barrel.

**REMARKS:**

After replacing the hour clutch spring it should be checked to see that the fork-shaped end "A" of spring does not hold too strong a downward pressure on the hour clutch. Too strong a downward tension at this point will cause the hour clutch to be unnecessarily hard to turn by the barrel, and thus cause a drag on the train of the watch.

**REFERENCE:** Hour clutch is Assembly 5.  
Hour register bridge is Assembly 4.  
Hour driving lever is Assembly 10.

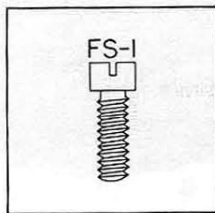



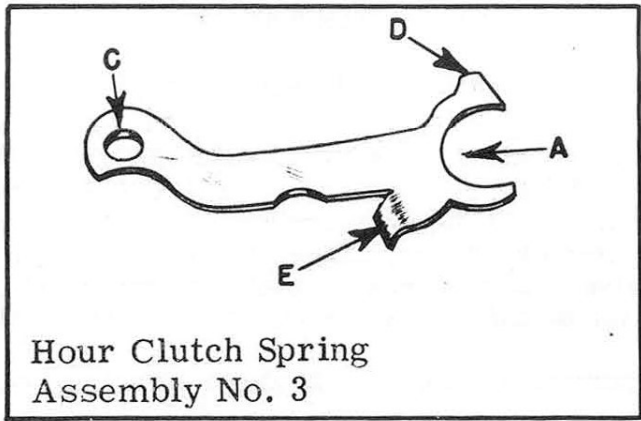

Hour Clutch Spring  
Assembly No. 3

OILING

The inclined surface "E" of hour clutch spring should be slightly moistened with oil at point of contact with pin "A" of hour driving lever.

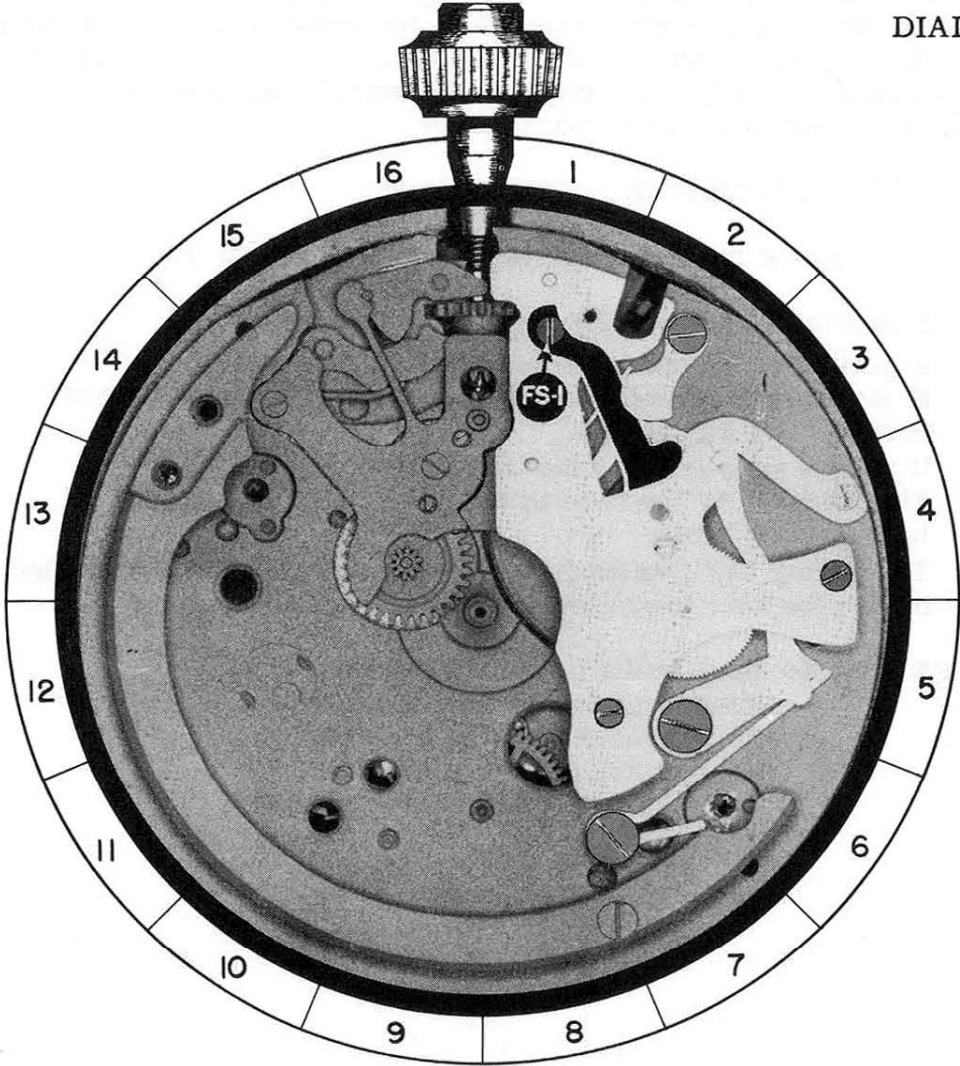

DIAL SIDE

3-A

**A. DISASSEMBLY PROCEDURE OF HOUR REGISTER BRIDGE:**

The hour register bridge is held in place by two identical fillister head screws FS-2 and FS-3 and steady pins. Fillister head screw FS-1, which was removed with the previous part also helps to hold this bridge down on plate. Remove the two screws FS-2 and FS-3, and slide a thin blade screw driver under bridge to loosen it from plate. When the steady pins are free, the bridge may be lifted out of place and free of movement.

(The shape of screws for this part is shown at bottom of page).

**B. ASSEMBLY PROCEDURE OF HOUR REGISTER BRIDGE:**

Before replacing the hour register bridge, observe on the photograph the proper position of the hour brake lever spring "C"; after this observation has been made, place the hour register bridge in its proper position. Make sure that the brake lever spring "C" is on the correct side of pin (A) on the brake lever, also make sure that the hour register wheel pivot and the barrel arbor pivot are entering the proper holes in the bridge. Now, as the bridge is pressed down to its proper place, move the spring "C" to its proper position on the outside surface of the brake lever, as shown on the photograph. Replace the two fillister head screws FS-2 and FS-3, that hold this bridge in place.

**C. FUNCTION OF HOUR REGISTER BRIDGE:**

The functions of the hour register bridge are as follows:

1. It provides a bearing for the barrel arbor.
2. It provides a bearing for the hour register wheel.
3. It serves as a base for the hour flyback lever, which pivots on post "G" on this bridge.
4. It serves as a base for the hour clutch spring.
5. The surface "A" serves as a guide and a stop for pin "B" of hour driving lever.
6. The spring "C", which is mounted on the underside of bridge, forces the hour brake lever towards the hour register wheel.

**REFERENCE:** Hour brake lever is Assembly 7.  
Hour register wheel is Assembly 6.  
Hour flyback lever is Assembly 2.  
Hour clutch spring is Assembly 3.  
Hour driving lever is Assembly 10.

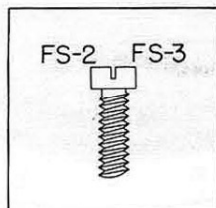

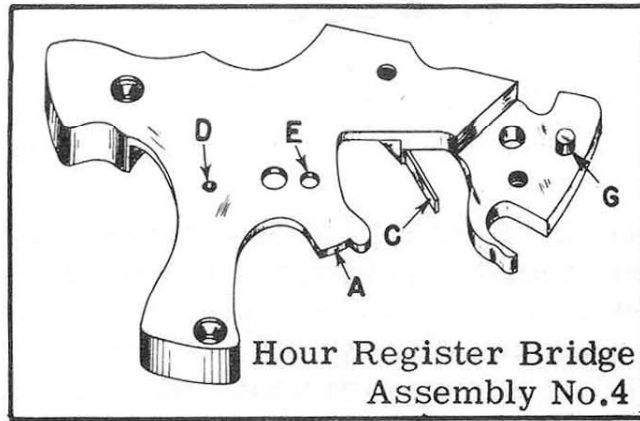

### OILING

Moisten hour register bridge slightly with oil at these points:  
 1. Surface "A" that contacts pin "B" on hour driving lever.  
 2. Spring "C" at point of contact with hour brake lever.  
 Oil barrel arbor and hour register wheel pivots as you would  
 the train pivots.

DIAL SIDE

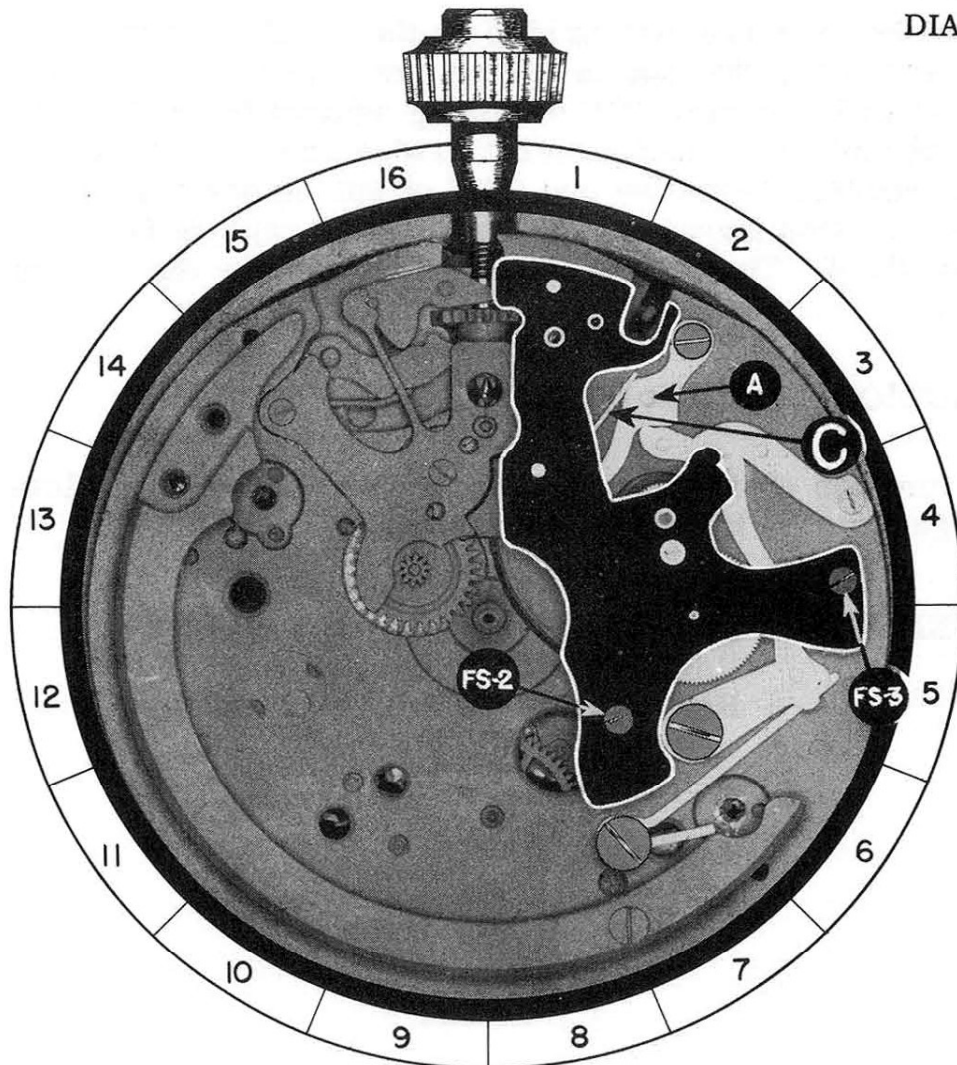

4-A

**A. DISASSEMBLY PROCEDURE OF HOUR BRAKE LEVER SPRING:**

The hour brake lever spring fits in a recess in the underside of the hour register bridge, and is held in place by fillister head screw FS-4. To remove the spring, place the hour register bridge on bench with the pin "B" up. Remove screw, and lift the end "A" of spring with a pair of tweezers. When end "A" of spring is above the recess, the spring will be free on the bridge and may be lifted out of place.

(The shape of screw for this part is shown at bottom of page.)

**B. ASSEMBLY PROCEDURE OF HOUR BRAKE LEVER SPRING:**

Place the hour register bridge on the bench with the pin "B" up. Now place the loop in spring over the hollow post in the recess with the part "C" of spring against the wall of recess, and the end "A" resting on the bridge above the recess. Now, with tweezers, force the end "A" of spring down in the recess to the position shown on the drawing, and replace fillister head screw FS-4. The spring should be free under the head of the screw.

**C. FUNCTION OF HOUR BRAKE LEVER SPRING:**

The function of this spring is to force the hour brake lever to engage with the hour register wheel.

**REFERENCE:** Hour brake lever is Assembly 7.  
Hour register bridge is Assembly 4.  
Hour register wheel is Assembly 6.

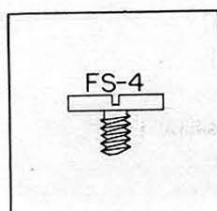

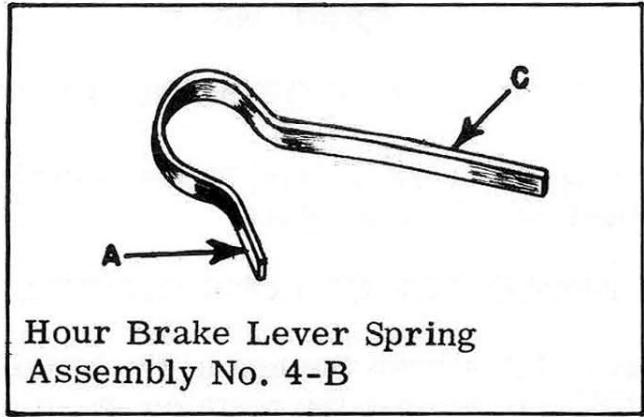

### OILING

The hour brake lever spring will be oiled later.

DIAL SIDE

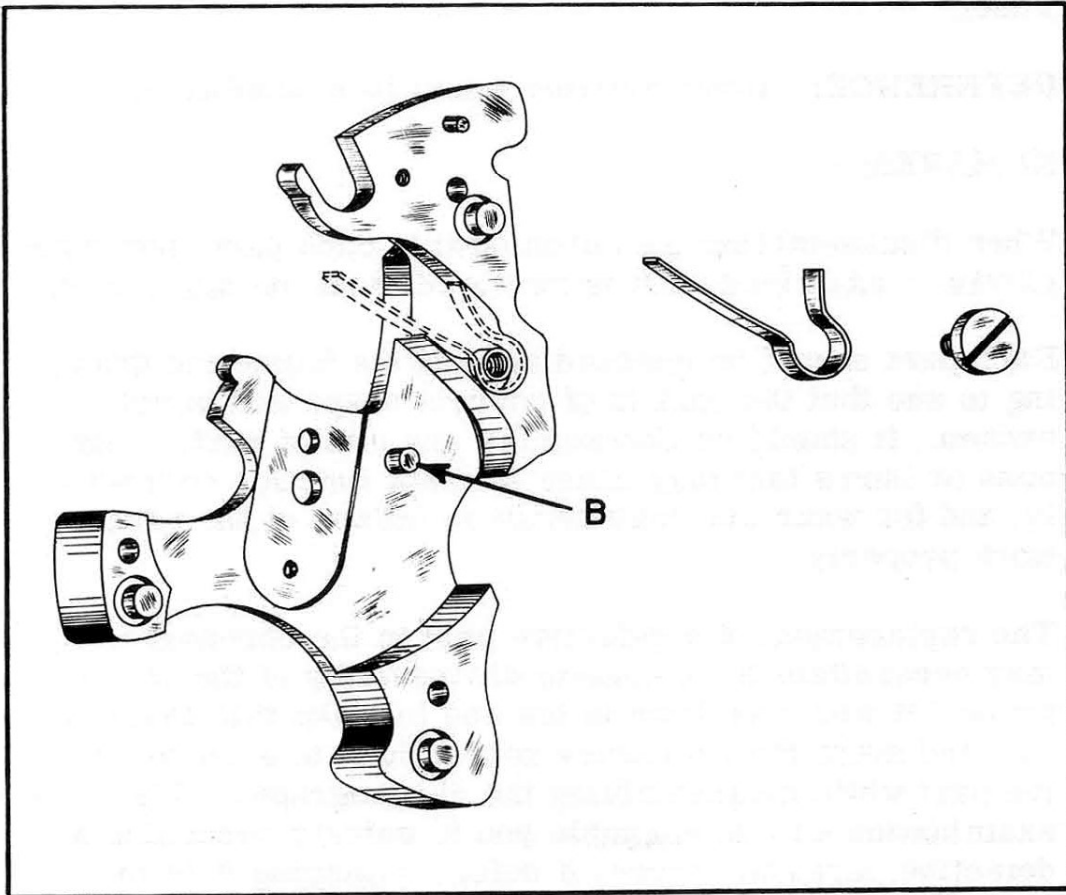

4-C

**A. DISASSEMBLY PROCEDURE OF HOUR CLUTCH:**

The hour clutch pivots on the end of the barrel arbor. To remove it, simply lift it out of place.

**B. ASSEMBLY PROCEDURE OF HOUR CLUTCH:**

Place the hour clutch over the end of the barrel arbor, with the groove "B" up, so that the teeth on the clutch are meshing with the teeth on the hour register wheel. Now, press the clutch down, so the crown teeth on the lower side of clutch mesh with the crown teeth on barrel. Check to see that the clutch is free on barrel arbor.

**C. FUNCTION OF HOUR CLUTCH:**

The function of the hour clutch, when engaged, is to transmit the power from the main spring barrel to the hour register wheel.

**REFERENCE:** Hour register wheel is Assembly 6.

**REMARKS:**

When disassembling the chronograph, each part should be carefully examined as it is removed from the movement.

Each part should be checked against the isometric drawing to see that the part is of correct shape and is not broken. It should be checked for any pits of rust, roughness or burrs that may cause it to not function correctly, and for wear that may result in failure of the part to work properly.

The replacement of a defective part in the chronograph may necessitate the complete disassembly of the chronograph. It will save time in the end to make this examination, and make the necessary corrections to each defective part while disassembling the chronograph. This close examination will soon enable you to quickly recognize a defective part, and correct it before replacing it in the chronograph.

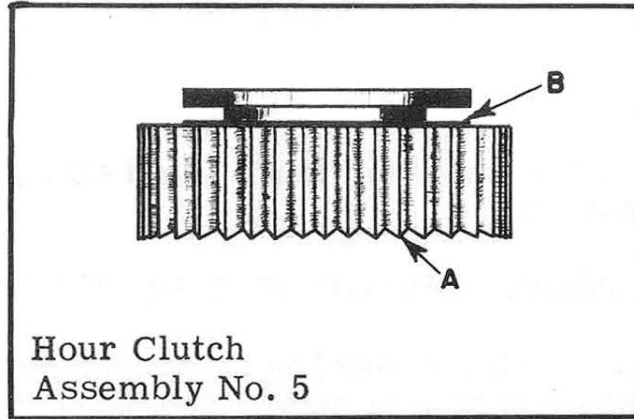

### OILING

The part of the barrel arbor that the hour clutch pivots on, should be slightly moistened with oil.

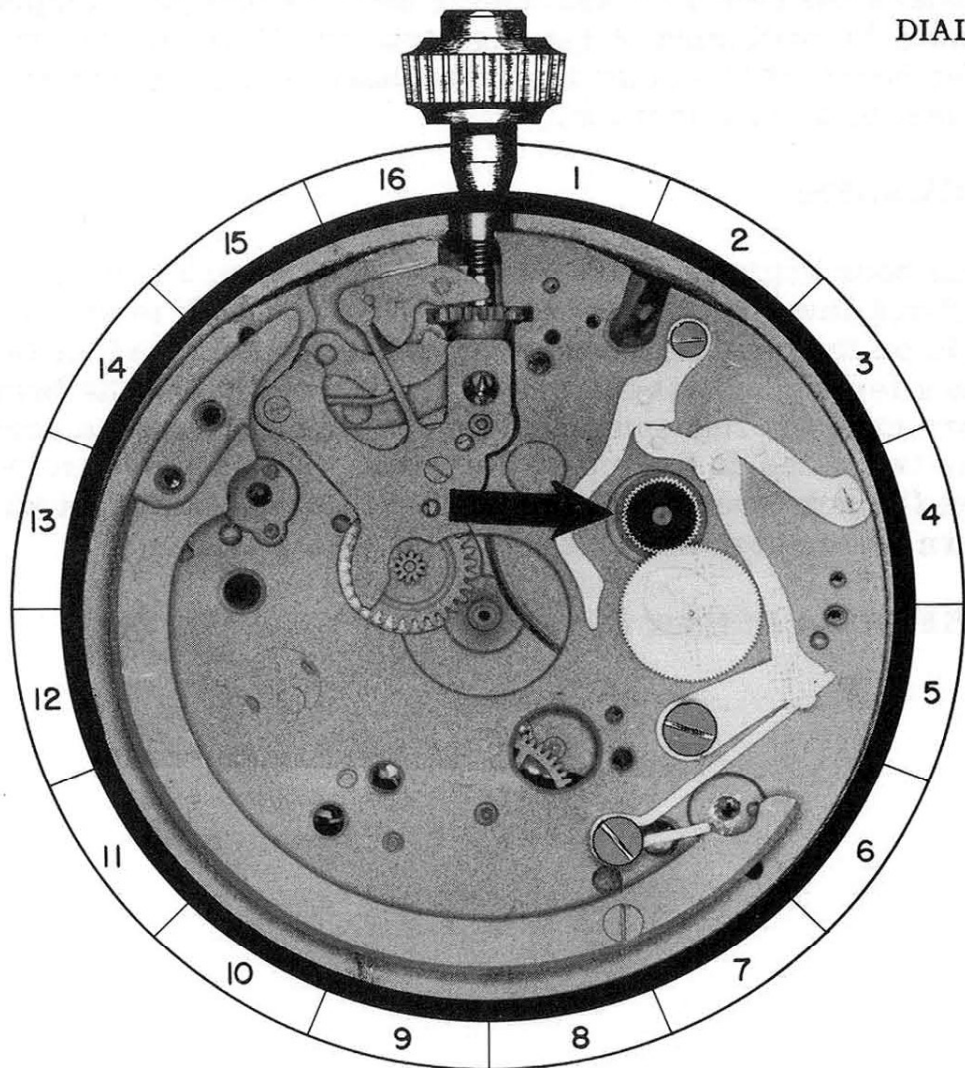

DIAL SIDE

5-A

**A. DISASSEMBLY PROCEDURE OF HOUR REGISTER WHEEL:**

The hour register wheel is simply lifted straight up out of place, to remove it.

**B. ASSEMBLY PROCEDURE OF HOUR REGISTER WHEEL:**

Place the hour register wheel in its proper position with the pivot entering pivot hole in plate. The heart "A" on this wheel must face up.

**C. FUNCTION OF HOUR REGISTER WHEEL:**

The function of the hour register wheel, by means of a hand attached to the long pivot "B" of the hour register wheel, registers the half hour and hourly periods that have elapsed, since the beginning of the registration of the chronograph. The heart "A" attached to this wheel is used to return the wheel to a zero position.

**REMARKS:**

The hour register wheel is returned to a zero position by the flyback lever contacting the heart "A", which is set eccentric on the hour register wheel. The flat end "A" of the flyback lever contacts the eccentric heart, forcing the heart to turn until the flat end of the hour flyback lever sets across the two lobes at the top of the heart. With the pressure of the flyback lever equalized at these points, the heart will turn no further, and this will be a zero position.

**REFERENCE:** Hour flyback lever is Assembly 2.



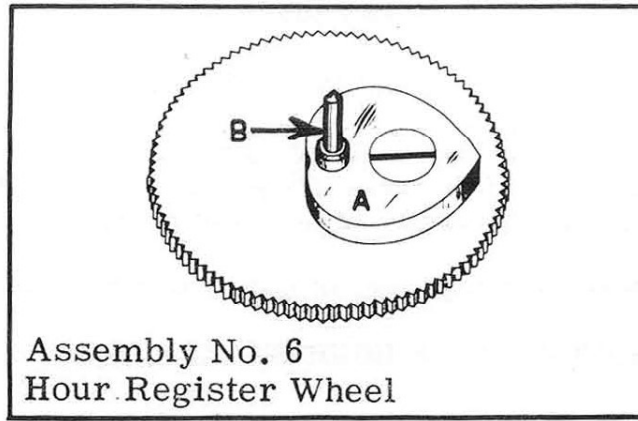

Assembly No. 6  
Hour Register Wheel

### OILING

The bottom pivot of hour register wheel should be oiled before placing it in pivot hole; the top pivot is oiled after bridge for this wheel is replaced.

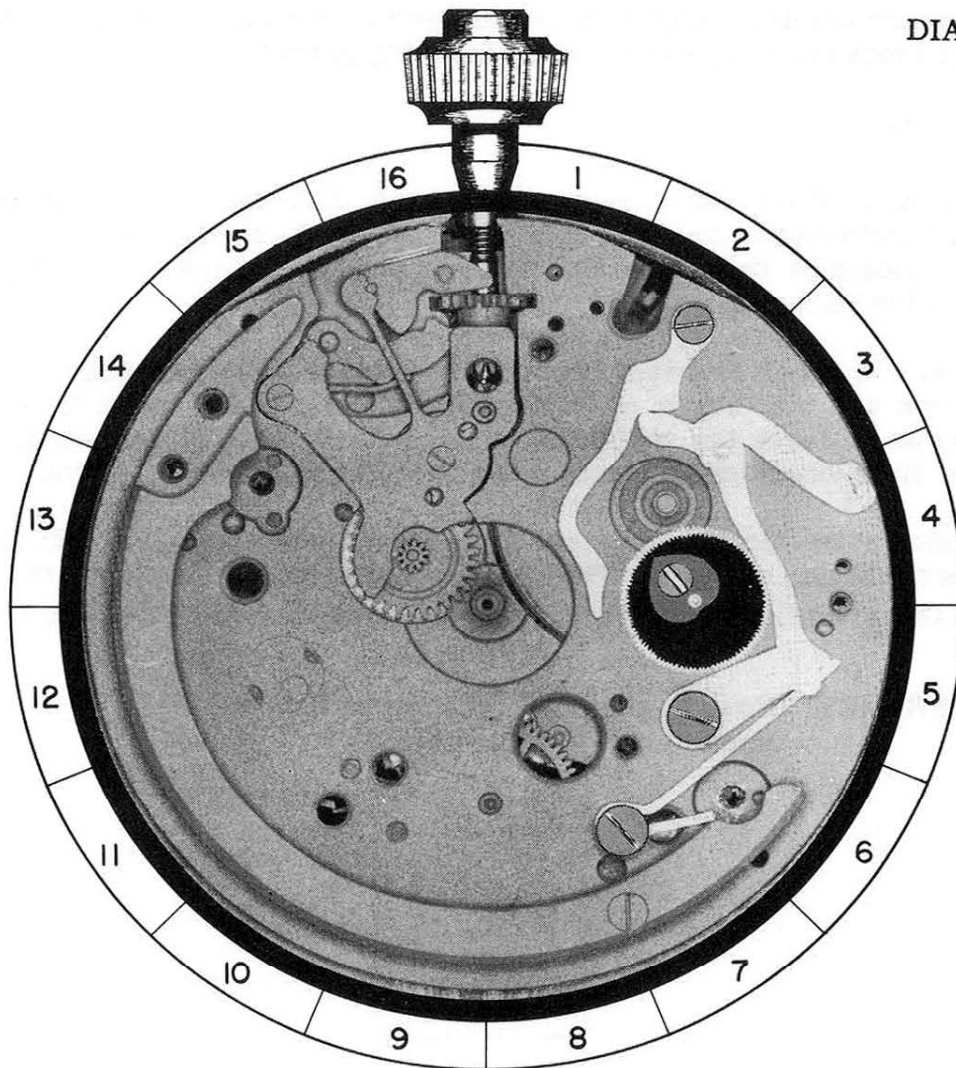

DIAL SIDE

6-A

**A. DISASSEMBLY PROCEDURE OF HOUR BRAKE LEVER:**

The hour brake lever is held in place by shouldered screw SS-2, and pivots on this screw. After screw SS-2 has been removed, the lever will be free on plate and can be lifted out of place.

(The shape of screw for this part is shown at bottom of page.)

**B. ASSEMBLY PROCEDURE OF HOUR BRAKE LEVER:**

Place the hour brake lever in its proper position on the plate, as shown on the photograph, with the hole in lever over screw hole in plate. Now replace shouldered screw SS-2, and check to see that lever pivots freely under the head of this screw.

**C. FUNCTION OF HOUR BRAKE LEVER:**

The function of hour brake lever is to hold the hour register wheel in a stationary position, when the crown teeth on the hour clutch are disengaged from the crown teeth on mainspring barrel.

**REMARKS:**

Many parts of the chronograph mechanism, that pivot or turn to perform their functions, are held in place by shouldered screws. Each of these parts should be checked to see that the shoulder of the screw properly fits the parts.

The way to check this is by replacing the part in the chronograph mechanism and with a pair of tweezers, grip the part and move it in such a way as to check the sideshake and endshake; also, of course, at the same time checking to see that the part is free and not binding.

Any excessive sideshake or endshake can, many times, prevent the proper function of a part. This makes it absolutely necessary that each part that works under the head of a shouldered screw be carefully checked.

**REFERENCE:** Hour register wheel is Assembly 6.  
Hour clutch is Assembly 5.

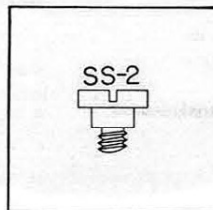

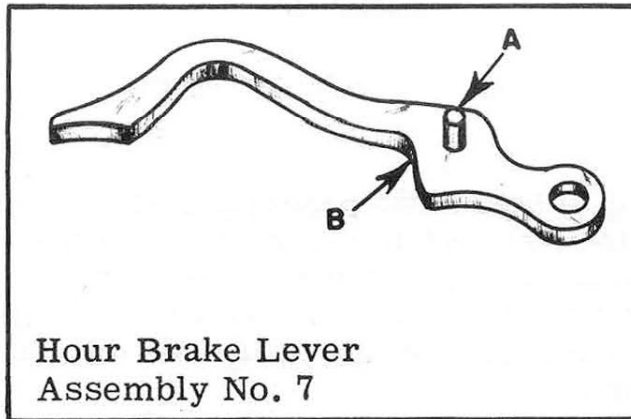

### OILING

The hour brake lever should be slightly moistened with oil at these points;

1. Shoulder of screw on which lever pivots.
2. Point "B" which contacts the hour driving lever.

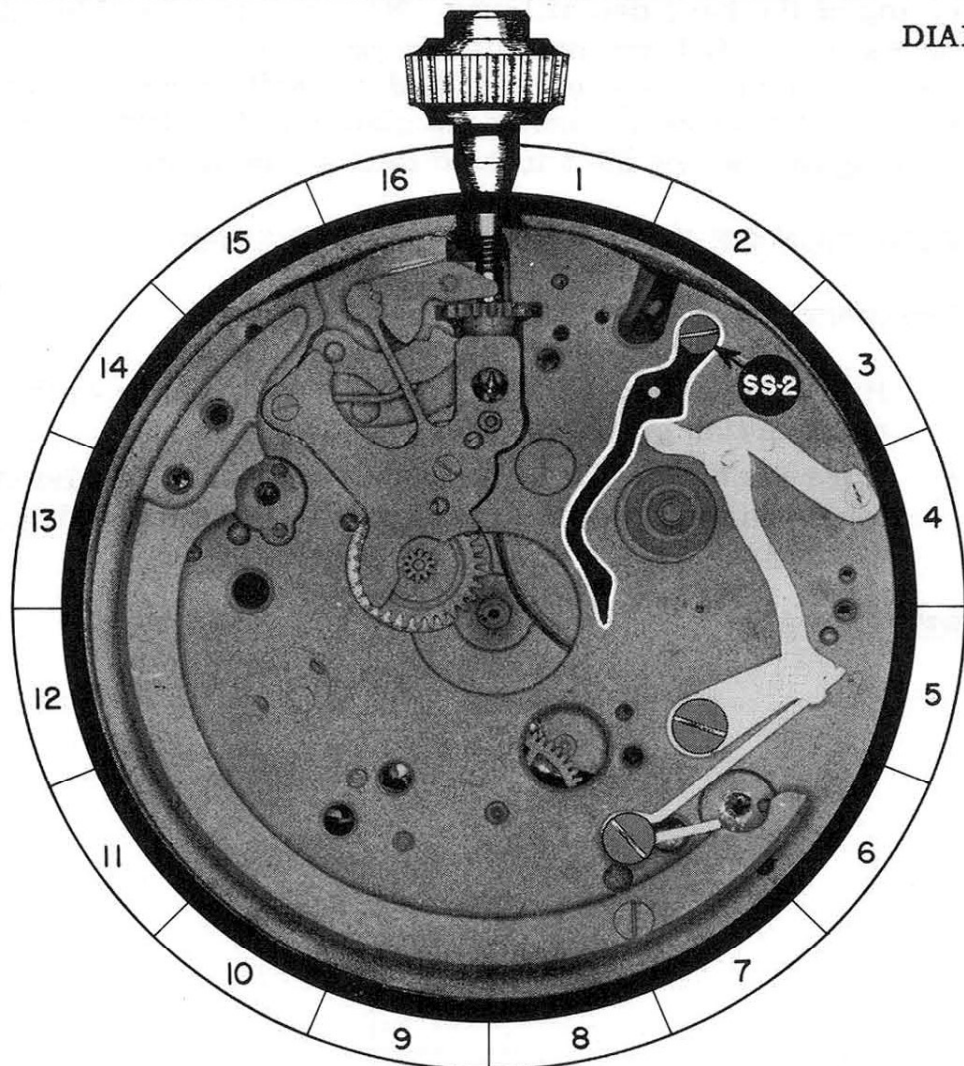

DIAL SIDE

7-A

**A. DISASSEMBLY PROCEDURE OF HOUR DRIVING LEVER SPRING:**

This spring is held in its proper position by shouldered screw SS-3, and the hour detent lever. Release the tension of the spring by loosening the screw SS-3 one turn, and lifting end "A" of spring over the end of hour detent lever. Now, remove screw SS-3, and the spring will be free on plate and may be lifted out of place.

(The shape of screw for this part is shown at bottom of page).

**B. ASSEMBLY PROCEDURE OF HOUR DRIVING LEVER SPRING:**

Place this spring in position with the loop in spring over the proper screw hole in plate; the end "A" of spring should be on top of the hour detent lever. Now replace shouldered screw SS-3. But, before this screw is tightened, grip end "A" of spring with tweezers, and place it in position under the end of hour detent lever, as shown on the photograph. Now tighten screw SS-3 to hold this spring in place.

**C. FUNCTION OF HOUR DRIVING LEVER SPRING:**

The functions of this spring are as follows:

1. It provides the hour driving lever with power so that it can function properly.
2. It forces the beak "B" of hour register switch lever (on train side of watch) towards the castle wheel, so that these parts can function properly.

**REFERENCE:** Hour driving lever is Assembly 10.  
Hour detent lever is Assembly 9.  
Hour register switch lever is Assembly 37.  
Castle wheel is Assembly 38.

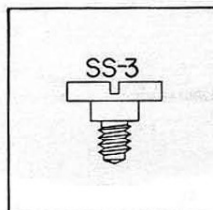

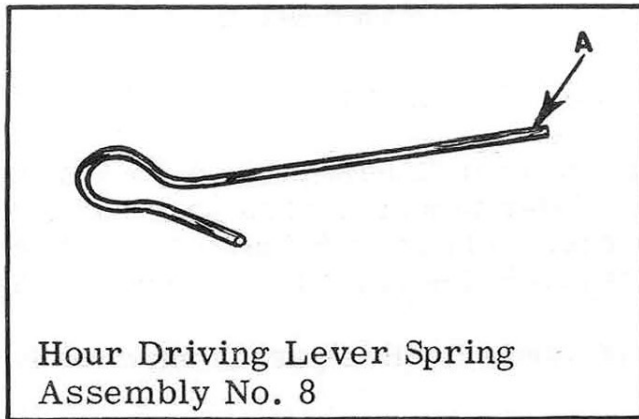

### OILING

End "A" of hour driving lever spring should be slightly moistened with oil at point of contact with hour driving lever.

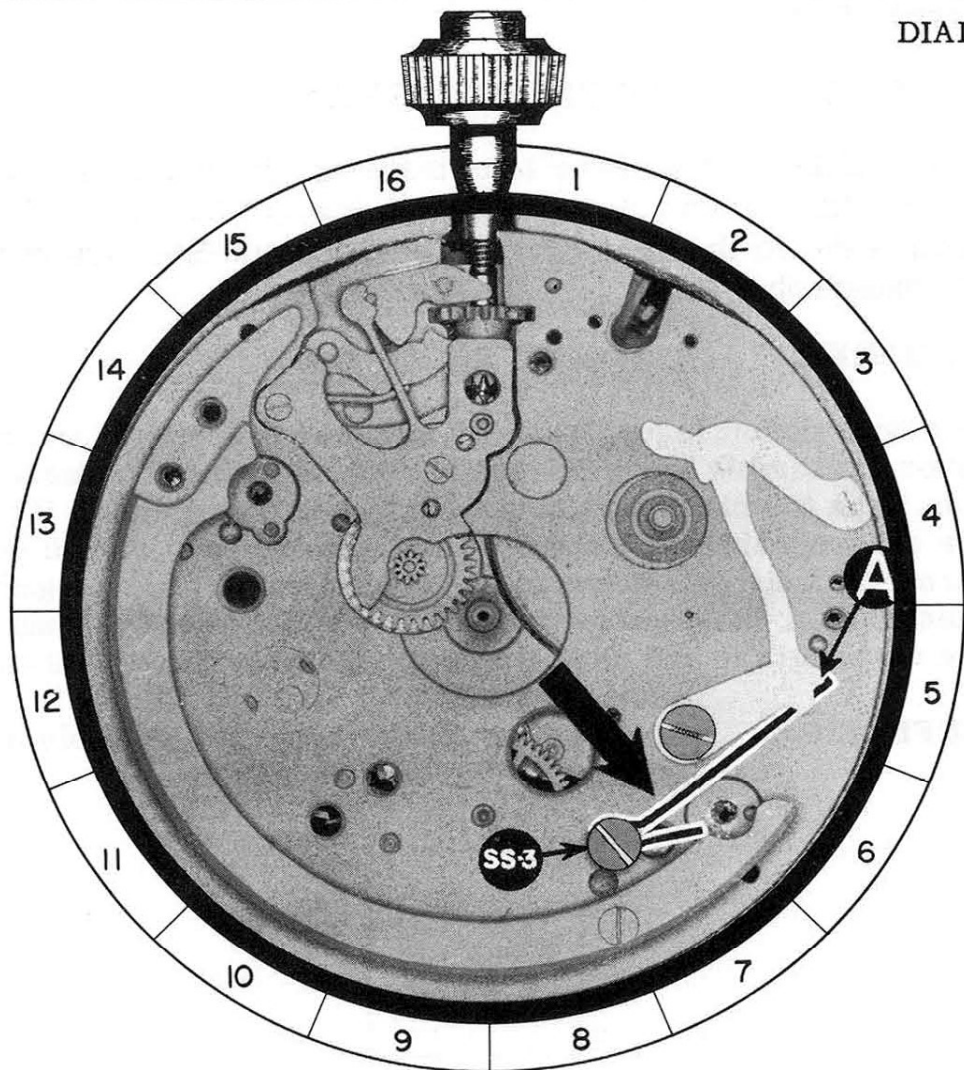

8-A

**A. DISASSEMBLY PROCEDURE OF HOUR DETENT LEVER:**

The hour detent lever is held in place by a fillister head screw FS-5. After this screw has been removed, the lever may be loosened from end "A" of post (on Assembly No. 37), and then lifted from the pin "D" on hour driving lever.

(The shape of screw for this part is shown at bottom of page).

**B. ASSEMBLY PROCEDURE OF HOUR DETENT LEVER:**

Before replacing this part, check to see that the beak "B" of hour register switch lever is meshing between two columns on the castle wheel, then place detent lever with hole "B" in lever over the end "A" of post on hour switch lever, and hole "C" over pin "D" on driving lever. Now replace screw FS-5.

**C. FUNCTION OF HOUR DETENT LEVER:**

The function of this lever is to transmit the power or movement from the hour register switch lever, which is on the train side, to the hour driving lever on the dial side of the chronograph.

**REMARKS:**

The hour detent lever, which is attached to the hour switch lever (Assembly #37), disengages the hour register mechanism when the chronograph mechanism is disengaged. When the chronograph mechanism is engaged, the hour switch lever turns the hour detent lever, which engages the hour register mechanism. This makes it possible to engage and disengage the chronograph and hour register mechanism simultaneously.

**REFERENCE:** Hour register switch lever is Assembly 37.  
Hour driving lever is Assembly 10.

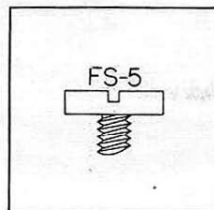

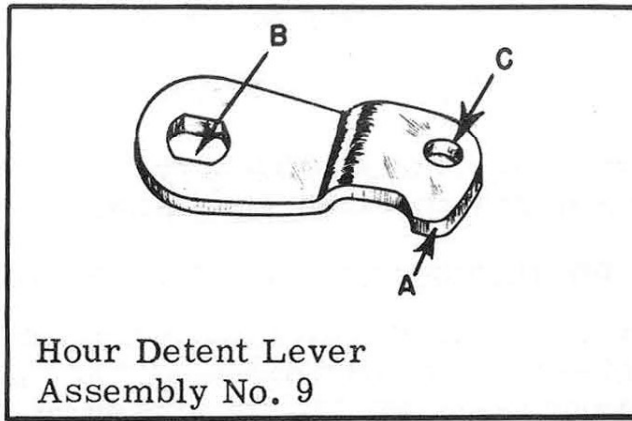

Hour Detent Lever  
Assembly No. 9

### OILING

The pin "D" on the hour driving lever where it fits through the hole "C" on hour detent lever, should be slightly moistened with oil.

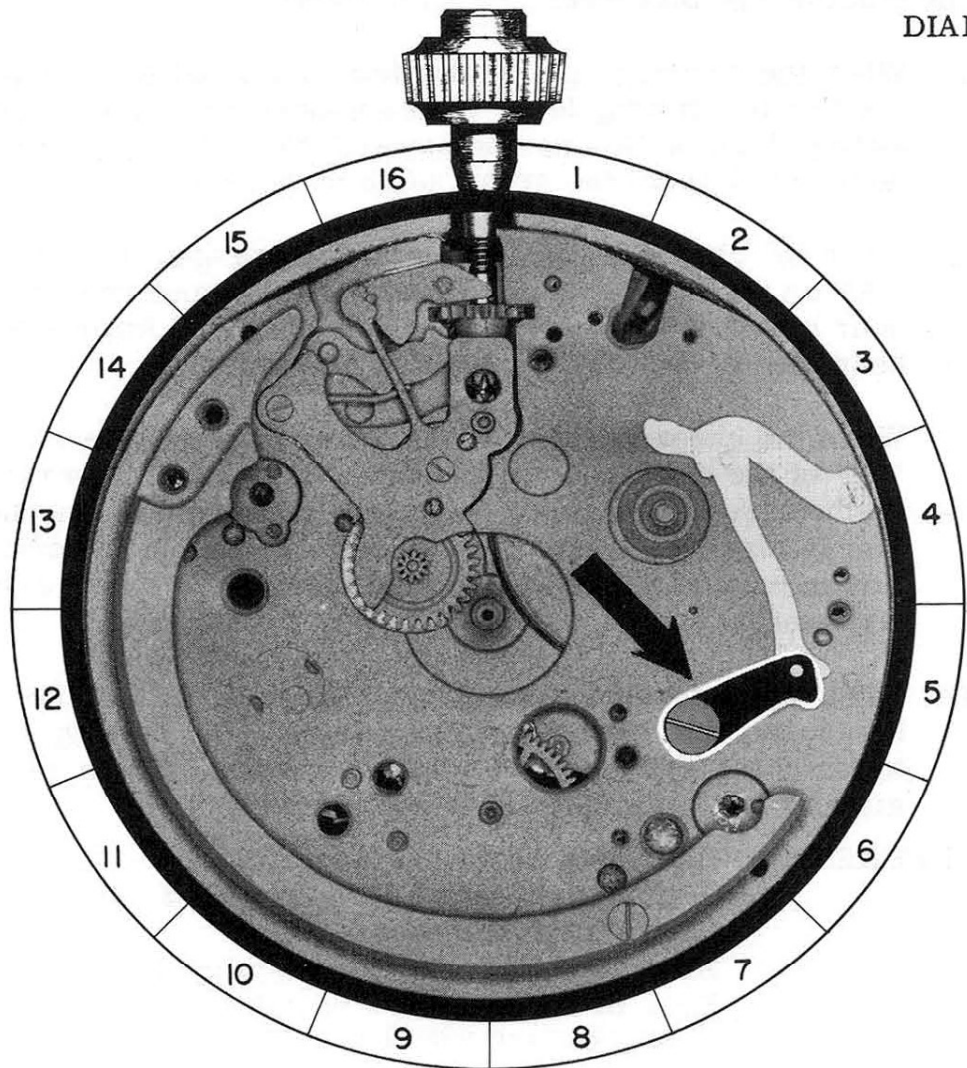

DIAL SIDE

9-A

**A. DISASSEMBLY PROCEDURE OF HOUR DRIVING LEVER:**

To remove this lever, simply slide it out from under hour hook bridge and lift it free from movement.

**B. ASSEMBLY PROCEDURE OF HOUR DRIVING LEVER:**

Before replacing this part, check to see that the beak "B" on the hour register switch lever, Assembly No. 37, on the train side of the watch is between two columns on the castle wheel. To replace the hour driving lever, slide this lever under hook bridge to position, as shown on photograph. The following part to be assembled fits over the pin "D" and holds the driving lever in place.

**C. FUNCTION OF HOUR DRIVING LEVER:**

The functions of this lever are as follows:

1. When the chronograph mechanism is disengaged, the pin "A" on the driving lever slides underneath the hour clutch spring, forcing this spring upward, thus disengaging the hour clutch from the crown teeth on barrel.
2. When the chronograph mechanism is engaged, the pin "A" on the driving lever slides out from underneath the hour clutch spring, permitting this spring to engage the hour clutch with the crown teeth on barrel.
3. When the chronograph mechanism is engaged, the end "C" of the driving lever disengages the brake lever from the hour register wheel. When the chronograph mechanism is disengaged, the driving lever moves in the direction to permit the brake lever to contact the hour register wheel.
4. When the chronograph is engaged, the pin "B" on the lever prevents the hour flyback lever from moving towards the center of the watch to return the hour register wheel to a zero position.

REFERENCE: Hour hook bridge is Assembly 11.  
Hour clutch spring is Assembly 3.  
Hour clutch is Assembly 5.  
Hour flyback lever is Assembly 2.  
Hour brake lever is Assembly 7.  
Hour register wheel is Assembly 6.



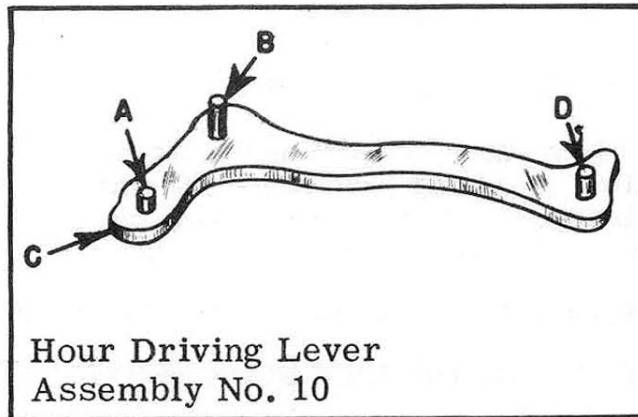

**OILING**

All the locations on the hour driving lever that should be oiled, will be oiled later.

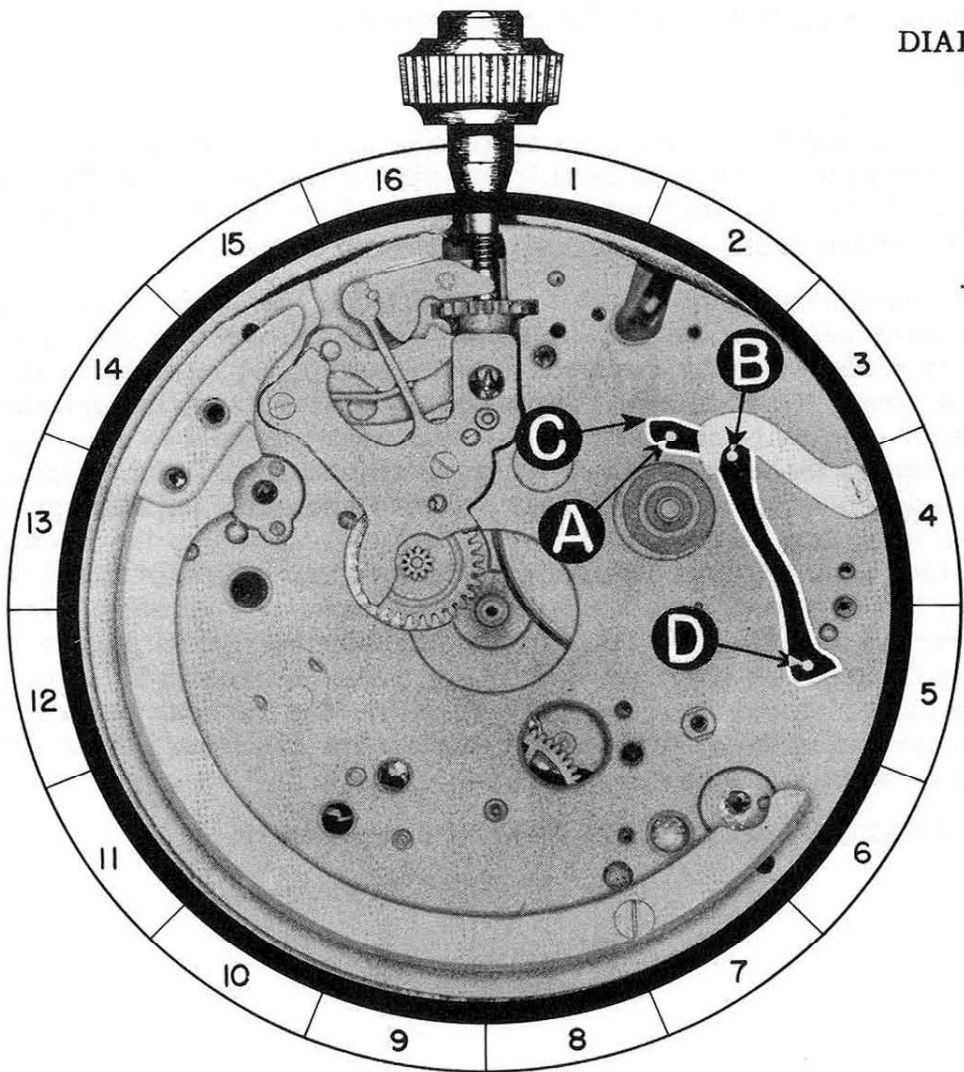

10-A

**A. DISASSEMBLY PROCEDURE OF HOUR HOOK BRIDGE:**

This bridge is held in place by a beveled countersink screw BS-3, and a steady pin. After screw has been removed, slide a thin blade screwdriver between bridge and plate. When steady pin is free in hole in plate, the bridge may be lifted free of movement.

(The shape of screw for this part is shown at bottom of page.)

**B. ASSEMBLY PROCEDURE OF HOUR HOOK BRIDGE:**

Place this bridge in position on plate, with the steady pin in the proper hole and the hole in bridge over the proper screw hole in the plate, as shown on the photograph. Now replace beveled countersink screw BS-3 to hold this part in place.

**C. FUNCTION OF HOUR HOOK BRIDGE:**

The function of the hour hook bridge is to hold the hour driving lever down on the plate, so it can function properly.

**REMARKS:**

The simultaneous setting back to zero of the chronograph hands and the hour register hand is greatly simplified in this type of chronograph. This is due to the fact that the two flyback levers perform their function from two independent sources of power.

When the chronograph button is pushed to set the hands to zero, the trip lever releases the flyback lever, which is forced in towards the center of the watch by the flyback lever spring, which returns the chronograph hands to zero. While this is taking place, the manual pressure on the button returns the hour register hand to a zero position. Due to these two flyback levers performing their functions from two independent sources of power, there is no close adjustment to make to be sure that the two flyback levers will return the wheels to an exact zero position. In many other chronographs this is not the case. In the type of chronograph illustrated in the Esembl-O-Graf Library, Vols. #13, #17, #18, #20 and #21, the two flyback levers receive their power from one source. In these chronographs there is a very close adjustment to be made in order that the hour register flyback lever and the chronograph flyback lever can return their respective wheels to an exact zero position.

REFERENCE: Hour driving lever is Assembly 10.

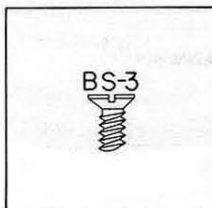

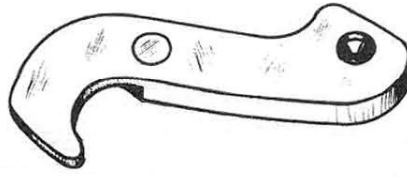

Hour Hook Bridge  
Assembly No. 11

### OILING

The hour hook bridge should not be oiled.

DIAL SIDE

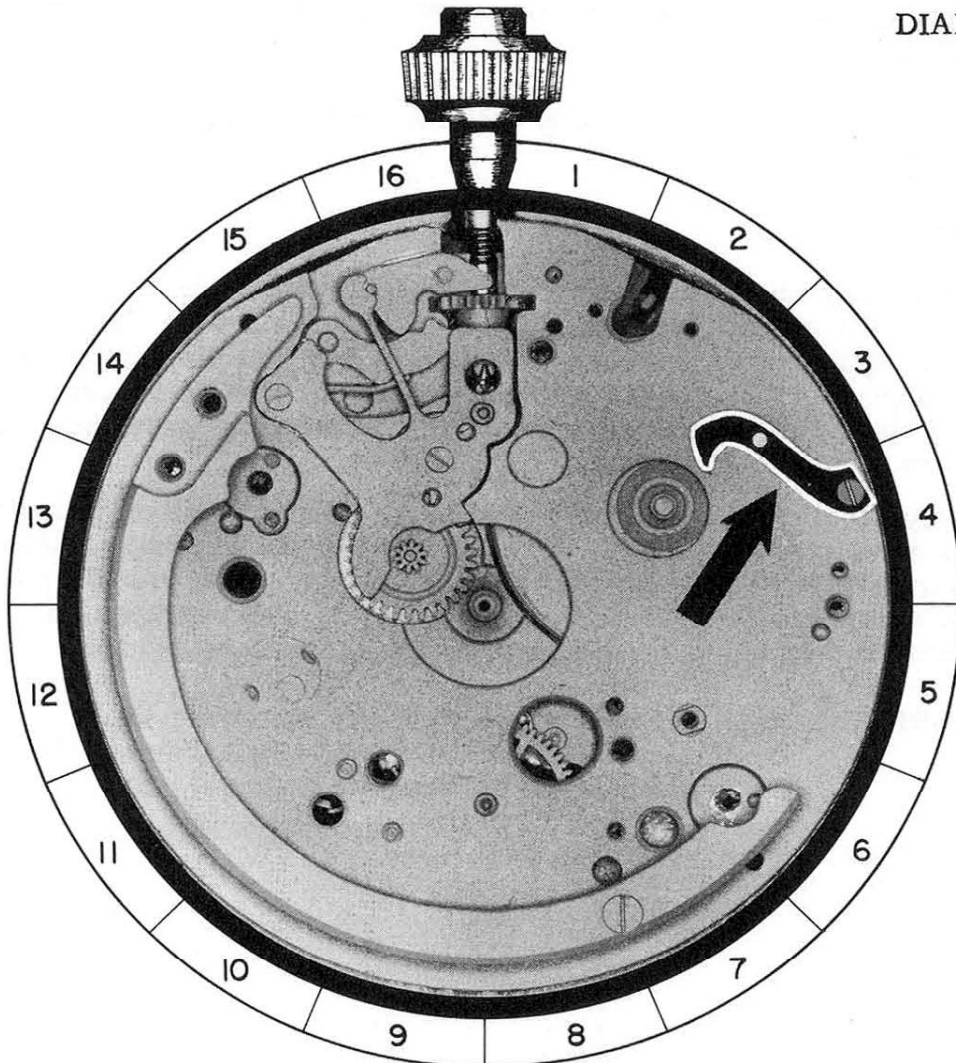

11-A

**A DISASSEMBLY PROCEDURE OF SPLIT SECONDS BRAKE SPRING HOLDER AND WASHER:**

The brake spring holder is held in place by beveled countersink screw BS-4, and is supported by a brass washer. When screw BS-4 has been removed, the holder and washer will be free, and can be lifted out of place.

(The shape of screw for this part is shown at the bottom of page.)

**B ASSEMBLY PROCEDURE OF SPLIT SECONDS BRAKE SPRING HOLDER AND WASHER:**

First place the supporting brass washer over proper screw hole in split seconds castle wheel pawl, then place the brake spring holder in position, as shown on photograph. Replace beveled countersink screw BS-4. The brake spring should move freely under this holder.

**C FUNCTION OF SPLIT SECONDS BRAKE SPRING HOLDER AND WASHER:**

The function of this holder is to hold the brake spring down in proper position.

**REMARKS:**

When disassembling the chronograph, each part should be carefully examined as it is removed from the movement. Each part should be checked against the isometric drawings to see that the part is the correct shape and is not broken. Each part should also be checked for any pits of rust, roughness, or burrs and for worn parts, which may cause the part not to work properly.

The replacement of a defective part in the chronograph may necessitate a complete disassembly of the chronograph. Through a close examination of each part you will soon become familiar with the parts of the chronograph. This will enable you to quickly recognize a defective part and repair it before replacing it in the chronograph.

**REFERENCE:** Split seconds brake spring is Assembly 13.  
Split seconds castle wheel pawl is Assembly 17.  
Split seconds castle wheel is Assembly 20.

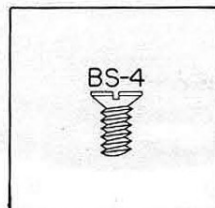

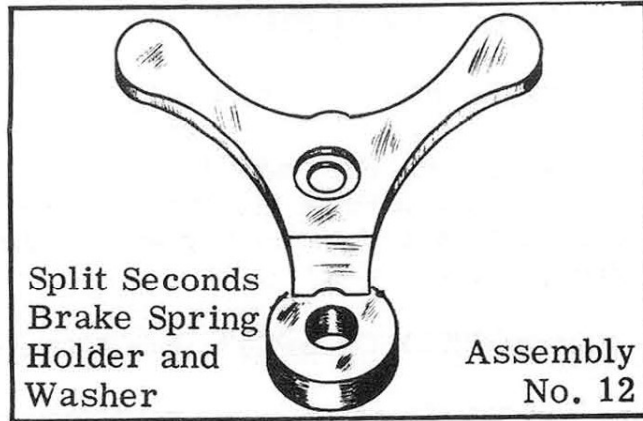

### OILING

The split seconds brake spring holder should not be oiled.



12-A

**A. DISASSEMBLY PROCEDURE OF SPLIT SECONDS BRAKE SPRING:**

Place the point of your tweezers under the corner "D" of the spring and lift up. This will raise the base of the spring from the stud. Now grip the base of the spring with a pair of tweezers and slide the spring out of place.

**B. HAZARDS IN DISASSEMBLY OF SPLIT SECONDS BRAKE SPRING:**

When raising up on base of spring, place your finger over the points "A" and "B", so the spring cannot snap out of place and become lost. Also care should be taken when sliding the spring out of place, that the split seconds wheel is not damaged.

**C. ASSEMBLY PROCEDURE OF SPLIT SECONDS BRAKE SPRING:**

Before replacing the split seconds brake spring, move the split seconds castle wheel to the position shown on the photograph. It is an advantage to have the split seconds castle wheel in this position, so when replacing the brake spring, the arms "E" and "F" will be spread sufficiently by the columns of the castle wheel, to clear the teeth of the split seconds wheel. This prevents any damage to the split seconds wheel while this spring is being replaced. To replace this spring, place the hole "C" in the base of spring over the steady pin on the split seconds castle wheel pawl. Spread the two arms of the brake spring until the points "A" and "B" clear the columns of the castle wheel and push spring down to the proper place.

**D. FUNCTION OF SPLIT SECONDS BRAKE SPRING:**

The function of the brake spring is to stop the split seconds wheel when the two ends exercise an equal pressure on the two opposite sides of the circumference of the wheel. The two points "A" and "B" of brake spring work in conjunction with the columns of the split seconds castle wheel. When the points "A" and "B" are in the space between the columns of the castle wheel, the arms "E" and "F" will be in contact with the split seconds wheel, keeping it from turning. When the castle wheel is turned one ratchet tooth, the columns will spread the points "A" and "B", causing the arms "E" and "F" to release the split seconds wheel, so it can turn.

**REMARKS:**

The fact that the brake spring can pivot freely on the steady pin "G", insures the equal pressure of the arms "E" and "F" on the split seconds wheel. This to some extent, prevents a sideward pressure on the seconds wheel which would cause the split seconds staff to be forced to one side, creating an added friction in the hollow post of the seconds wheel.

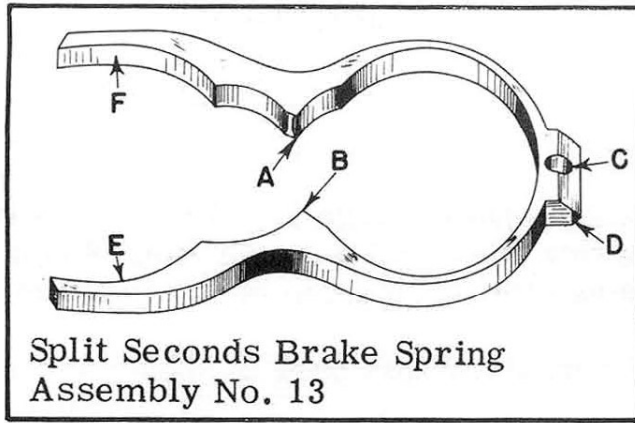

### OILING

The split seconds brake spring should not be oiled. The points "A" and "B" will receive the oil from the columns of the split seconds castle wheel.

TRAIN SIDE



13-A

**A. DISASSEMBLY PROCEDURE OF SPLIT SECONDS WHEEL BRIDGE:**

The split seconds wheel bridge is held in place by beveled countersink screw BS-5 and a steady pin. When screw BS-5 has been removed, the bridge can be lifted out of place.

(The shape of screw for this part is shown at bottom of page.)

**B. ASSEMBLY PROCEDURE OF SPLIT SECONDS WHEEL BRIDGE:**

Place the bridge in its proper position with the steady pin on bridge, entering the proper hole and the cap jewel over the center of split seconds wheel. Replace beveled countersink screw BS-5 to hold this part in place.

**C. FUNCTION OF SPLIT SECONDS WHEEL BRIDGE:**

The functions of this bridge are:

1. It controls the endshake of the split seconds wheel.
2. It prevents the split seconds castle wheel from riding up on the hollow stud on which it pivots.

**REMARKS:**

It cannot be too strongly emphasized that the split seconds wheel must be completely free to function properly. Just for this reason alone is why the split seconds wheel is not pivoted in a jewel hole on the top, but merely replaced with a cap jewel to control the upward movement of the split seconds wheel.

**REFERENCE:** Split seconds wheel is Assembly 15.  
Split seconds castle wheel is Assembly 20.

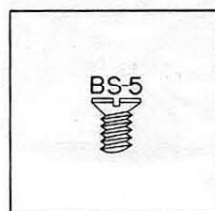



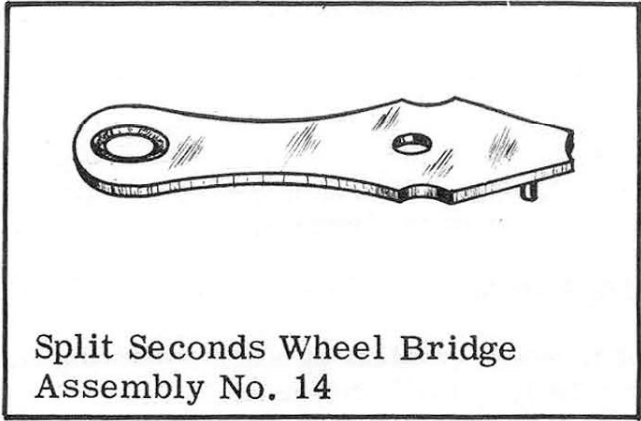

Split Seconds Wheel Bridge  
Assembly No. 14

OILING

The center of cap jewel in split seconds wheel bridge should be slightly moistened with oil.



TRAIN SIDE

14-A

**A. DISASSEMBLY PROCEDURE OF SPLIT SECONDS WHEEL:**

The long staff on the split seconds wheel fits down in the hollow seconds wheel staff. To remove the split seconds wheel, grip one of the spokes of the wheel with a pair of tweezers and lift straight up.

**B. HAZARDS IN DISASSEMBLY OF SPLIT SECONDS WHEEL:**

Lift split seconds wheel straight up when removing it, as any tilting of wheel may bend the long staff on wheel.

**C. ASSEMBLY PROCEDURE OF SPLIT SECONDS WHEEL:**

Place the long staff on this wheel down in the hollow seconds wheel post. Move lever "B" with jewel "C" away from the surface of heart. This will permit split seconds wheel to be pushed down to its proper place. The jewel "C" should rest against the outside surface of the split seconds heart.

**D. HAZARDS IN ASSEMBLY OF SPLIT SECONDS WHEEL:**

Do not move the lever "B" with jewel "C" on the split seconds wheel out any further than is necessary to clear the split seconds heart when replacing this wheel.

**E. FUNCTION OF SPLIT SECONDS WHEEL:**

The function of the split seconds wheel is to make it possible for the operator to make registrations with the split seconds hand and, at the same time, not interfere with a longer registration, which is being registered by the sweep seconds hand.

**F. HOW THE SPLIT SECONDS WHEEL PERFORMS ITS FUNCTION:**

The small spring "A" holds a slight pressure on lever "B" which keeps the jewel "C" in contact with the circumference of split seconds heart. When the split seconds heart is turning and the split seconds wheel is stopped, the split seconds heart will force the jewel "C" out from between the lobes on this heart. When the split seconds brake spring is disengaged from the split seconds wheel, permitting the split seconds wheel to turn, the pressure of jewel "C" on the split seconds heart will cause the split seconds wheel to rotate until the jewel "C" centers itself between the two lobes on the split seconds heart. This means that the split seconds wheel will always return to the same position in relation to the seconds wheel.

REFERENCE: Seconds wheel is Assembly 42.  
Split seconds heart is Assembly 16.  
Split seconds brake spring is Assembly 13.

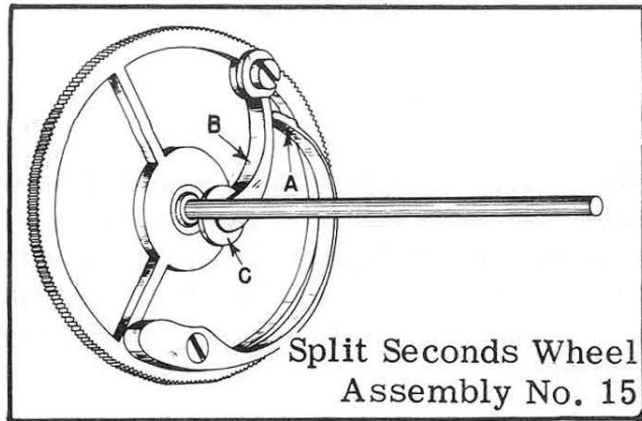

### OILING

The lever "B" of split seconds wheel should be slightly moistened with oil at point of contact with spring "A".



15-A

**A. DISASSEMBLY PROCEDURE OF SPLIT SECONDS HEART:**

To remove the split seconds heart, use two small screwdrivers. Place one screwdriver under the heart at location "A", and the other one under the heart at location "B". Turn one screwdriver clockwise and the other screwdriver counter-clockwise. This will remove the heart from the post of the seconds wheel.

**B. ASSEMBLY PROCEDURE OF SPLIT SECONDS HEART:**

Place the heart in position with the hole "C" over the end of hollow seconds wheel post. Stake the heart down with a hollow flat faced punch until the bottom of heart rests on the shoulder on seconds wheel post. There is no special position for the heart in relation to the seconds wheel.

**C. FUNCTION OF SPLIT SECONDS HEART:**

The function of the split seconds heart is to enable the split seconds wheel either to follow the rotation of the seconds wheel, or after being stopped, to turn back to a definite position in relation to the seconds wheel.

**REMARKS:**

The split seconds heart must be highly polished as when this heart is forcing the lever arm "B" on the split seconds wheel out, any added friction will cause that much more drag on the train of the watch.

Also when the split seconds brake spring releases the split seconds wheel, the lever arm "B" on this wheel may not have the force, due to the added friction, to return the split seconds wheel to its original position, in relation to the seconds wheel.

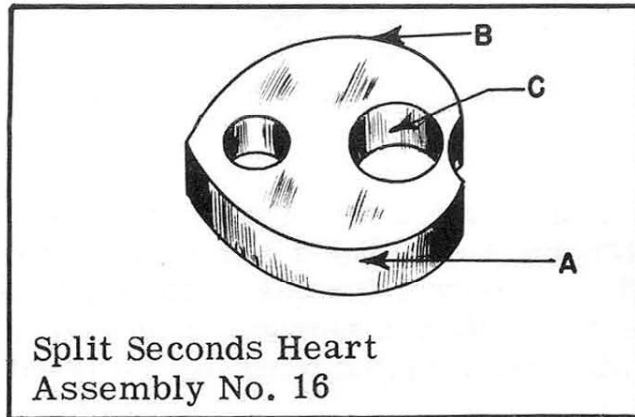

**OILING**

The split seconds heart should not be oiled.



16-A

**A. DISASSEMBLY PROCEDURE OF SPLIT SECONDS CASTLE WHEEL PAWL:**

The split seconds castle wheel pawl is held in place by beveled countersink screw BS-6 and steady pins. After the screw BS-6 is removed, the pawl can be loosened by sliding a thin blade screw driver between pawl and bridge. When the steady pins are free, the pawl can be lifted out of place.

(The shape of screw for this part is shown at bottom of page).

**B. ASSEMBLY PROCEDURE OF SPLIT SECONDS CASTLE WHEEL PAWL:**

Place the pawl in position on bridge with steady pins in proper holes and end "A" of pawl meshing with the ratchet teeth "B" on split seconds castle wheel. When the pawl is in position, as shown on photograph, replace beveled countersink screw BS-6 to hold this part in place.

**C. FUNCTION OF SPLIT SECONDS CASTLE WHEEL PAWL:**

The functions of this pawl are:

1. It holds the split seconds castle wheel in position until it is moved manually.
2. It correctly spaces the turning of the split seconds castle wheel.

**REFERENCE:** Split Seconds Castle Wheel Is Assembly 20.

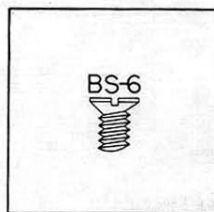

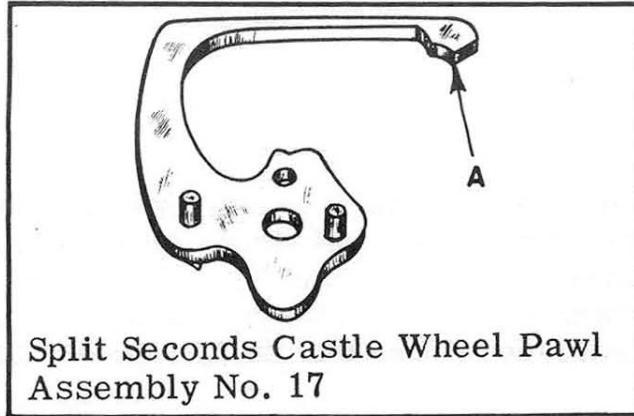

### OILING

The split seconds castle wheel pawl should not be oiled. It will receive its oil from the ratchet teeth on the castle wheel.

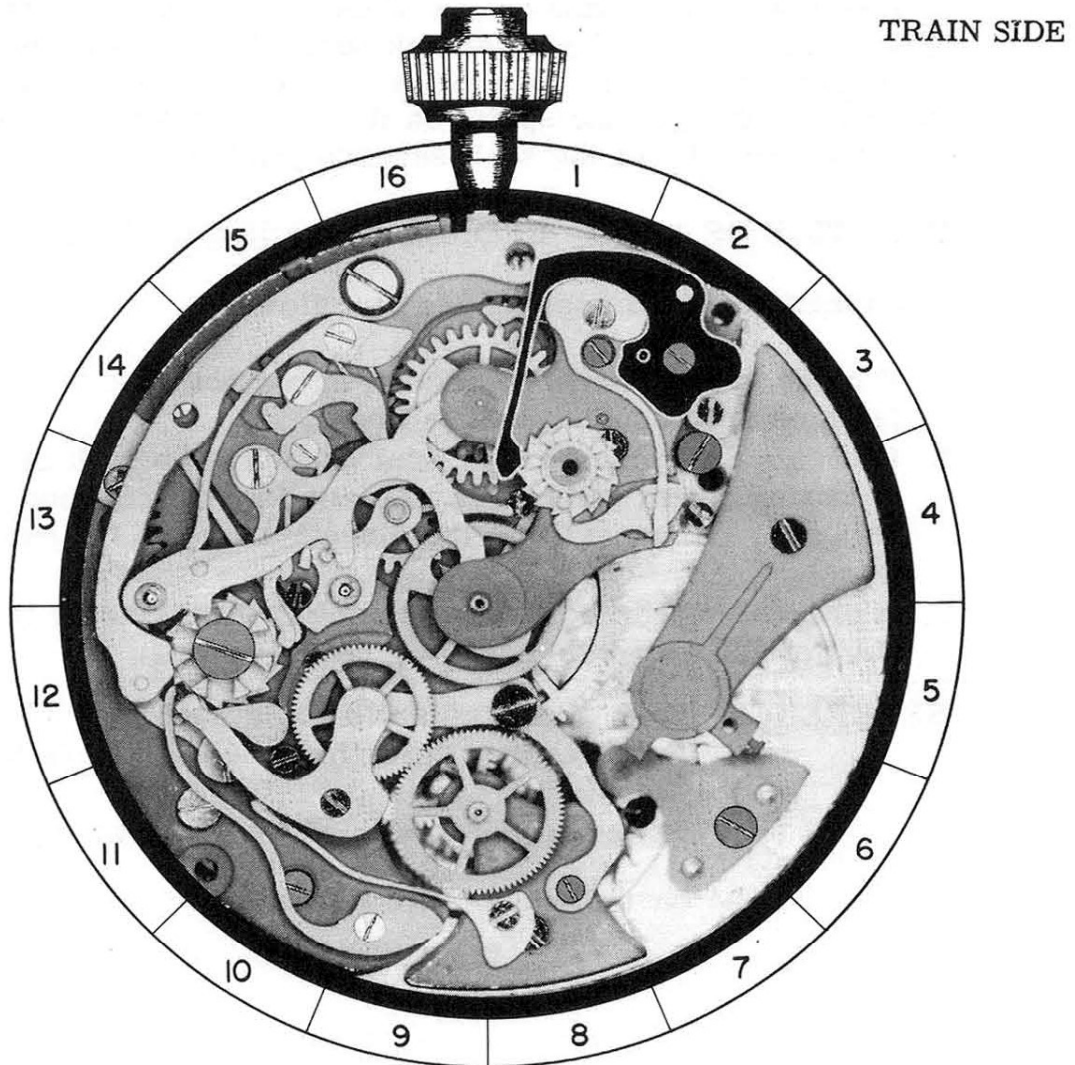

17-A

**A. DISASSEMBLY PROCEDURE OF SPLIT SECONDS JOINT HOOK SPRING:**

The split seconds joint hook spring is held in place by beveled countersink screw BS-7, and steady pins. After screw has been removed, the spring may be loosened by sliding a thin blade screwdriver between the spring and bridge. When steady pins are free, the spring may be lifted out of place.

(The shape of screw for this part is shown at bottom of page.)

**B. ASSEMBLY PROCEDURE OF SPLIT SECONDS JOINT HOOK SPRING:**

Place the split seconds spring in position with the steady pins on spring entering the proper holes in bridge. The end "A" of spring will be resting on top of the split seconds joint hook. Now, replace beveled countersink screw BS-7. But, before tightening screw, grip the end "A" of spring with a pair of tweezers and place the spring in its proper position against the shoulder "A" of the split seconds joint hook.

**C. FUNCTION OF SPLIT SECONDS JOINT HOOK SPRING:**

The functions of this spring are as follows:

1. It holds split seconds joint hook in contact with ratchet teeth on split seconds castle wheel.
2. It brings the split seconds joint hook and the split seconds actuating detent lever back to their original position after being moved manually in the direction to turn the castle wheel.
3. It prevents split seconds joint hook from riding up on pin "A" of split seconds actuating detent lever.

**REFERENCE:** Split seconds joint hook is Assembly 19.  
Split seconds actuating detent lever is Assembly 47.  
Split seconds castle wheel is Assembly 20.

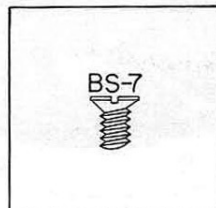



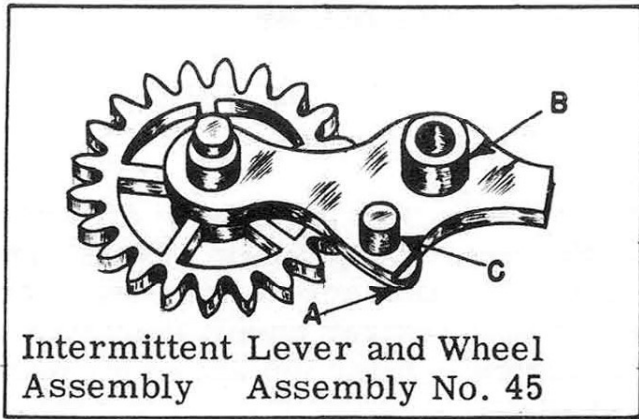

Intermittent Lever and Wheel  
Assembly Assembly No. 45

### OILING

The post that intermittent lever and wheel assembly pivots on should be slightly moistened with oil.

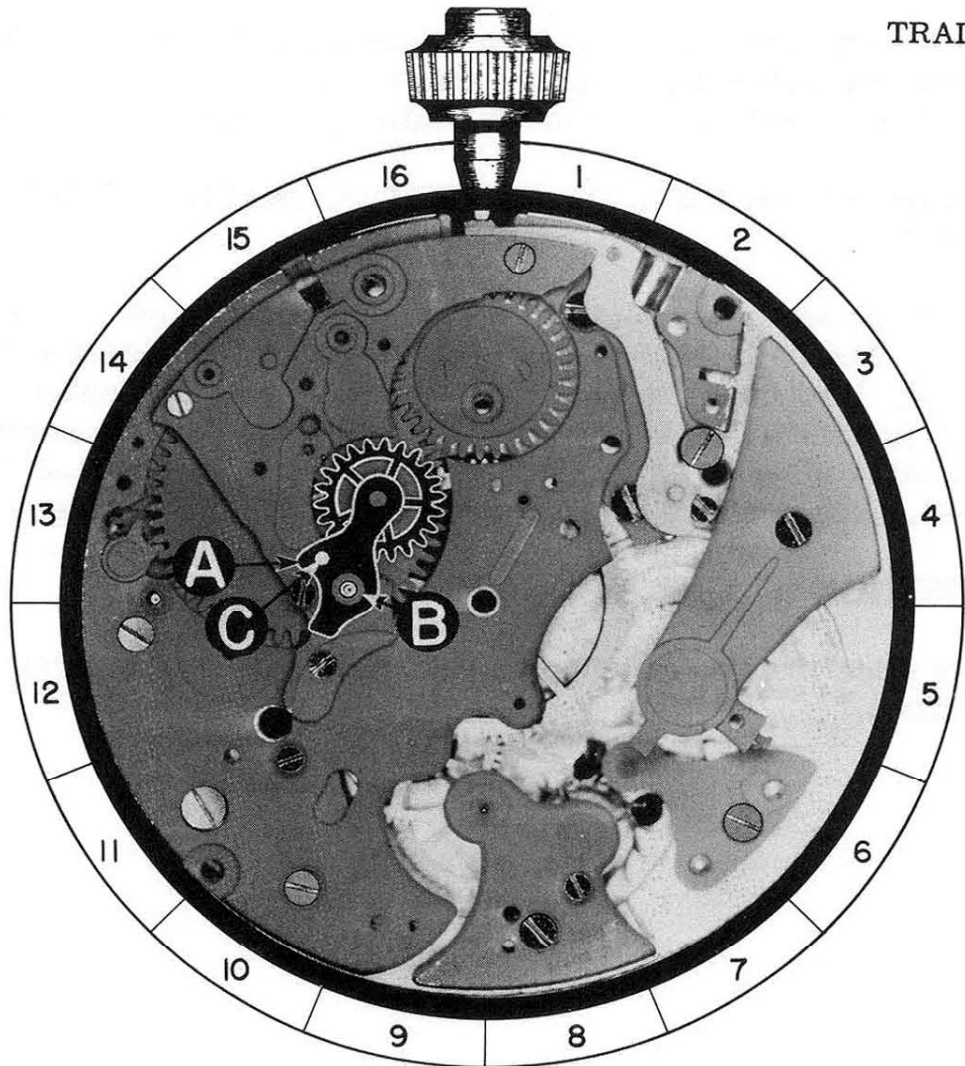

TRAIN SIDE

45-A

**A. DISASSEMBLY PROCEDURE OF SPLIT SECONDS JOINT HOOK:**

The split seconds joint hook pivots on pin "A" of split seconds actuating detent lever (Assembly No. 47), and is held in place by the split seconds joint hook spring, which has been removed. To remove joint hook, simply lift it straight up from pin "A" on split seconds actuating detent lever.

**B. ASSEMBLY PROCEDURE OF SPLIT SECONDS JOINT HOOK:**

Place the split seconds joint hook in position with hole "B" in joint hook over pin "A" of split seconds actuating detent lever. End "C" should contact ratchet teeth on split seconds castle wheel, as shown on photograph. The next part to be assembled will hold the split seconds joint hook in place.

**C. FUNCTION OF SPLIT SECONDS JOINT HOOK:**

The function of the split seconds joint hook is to move the split seconds castle wheel one tooth, each time the split seconds actuating detent lever is moved manually.

**D. REMARKS:**

The screw "D", shown on the photograph, controls the distance the joint hook can be moved in the direction to turn the castle wheel.

**REFERENCE:** Split seconds actuating detent lever is Assembly 47.

Split seconds castle wheel is Assembly 20.

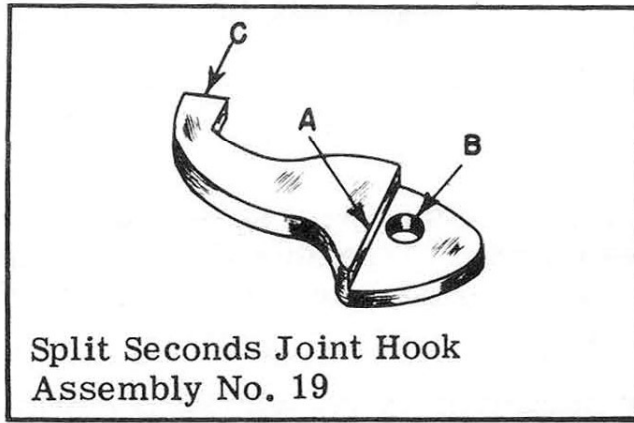

### OILING

Before replacing split seconds joint hook, pin "A" on split seconds actuating detent lever should be slightly moistened with oil.



19-A

**A. DISASSEMBLY PROCEDURE OF SPLIT SECONDS CASTLE WHEEL:**

The split seconds castle wheel is held in place by the split seconds wheel bridge (Assembly 14). To remove the split seconds castle wheel, simply lift it from the hollow stud on which it pivots.

**B. ASSEMBLY PROCEDURE OF SPLIT SECONDS CASTLE WHEEL:**

Place the split seconds castle wheel over the hollow stud, as shown on the photograph. The part which holds the split seconds castle wheel down in place, will be assembled later.

**NOTE: - - IMPORTANT**

Before assembling the split seconds mechanism, the minute register pawl (Assembly #40) should be adjusted as explained in the text on the adjustment of eccentric studs in front of book.

**C. FUNCTION OF SPLIT SECONDS CASTLE WHEEL:**

The split seconds castle wheel performs two functions:

1. It disengages the two ends of the split seconds brake spring from the split seconds wheel.
2. It permits the two ends of the split seconds brake spring to engage with the split seconds wheel.

**REMARKS:**

Either of the above two functions of the split seconds castle wheel should not take place until the point of the ratchet tooth on the castle wheel has moved over the point on the split seconds castle wheel pawl. This eliminates the possibility of either of the two functions of the split seconds castle wheel taking place if the split seconds button was only pressed slightly.

**REFERENCE:** Split seconds wheel bridge is Assembly 14.  
Split seconds brake spring is Assembly 13.  
Split seconds wheel is Assembly 15.

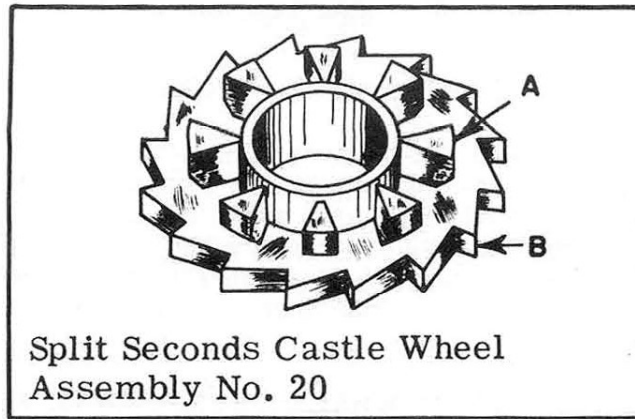

Split Seconds Castle Wheel  
Assembly No. 20

### OILING

The split seconds castle wheel should be slightly moistened with oil at these points;

1. The bearing surface of hollow stud on which the castle wheel pivots.
2. The columns "A" that contact split seconds brake spring.
3. The ratchet teeth "B"



TRAIN SIDE

20-A

**A. DISASSEMBLY PROCEDURE OF WHEEL OVER FOURTH WHEEL:**

The wheel over fourth wheel fits friction tight on long pivot of the fourth wheel pinion. This wheel should be removed with a sweep wheel remover, but can be removed with two small, thin-edged screwdrivers. The screwdrivers are placed opposite each other under hub "A" of wheel. One screwdriver is turned clockwise while the other screwdriver is turned counter-clockwise. This will loosen the wheel from the pivot, permitting it to be lifted out of place.

**B. HAZARDS IN DISASSEMBLY OF WHEEL OVER FOURTH WHEEL:**

The wheel over fourth wheel fits over the very thin, long pivot of fourth wheel pinion. This pivot, as you know, is very delicate and easily bent or broken. The main reason why we selected this part to be one of the first parts to be removed from the chronograph mechanism was to lessen the hazards of bending the long pivot on the fourth wheel pinion when removing the other parts of the chronograph mechanism. If the sweep wheel remover is held perfectly upright in removing wheel, hazard of bending fourth wheel pivot will be eliminated.

**C. ASSEMBLY PROCEDURE OF WHEEL OVER FOURTH WHEEL:**

This wheel fits over the long pivot of the fourth wheel and should be placed on the pivot with hub "A" of wheel down. The wheel over fourth wheel should be staked down until it is level with the intermediary wheel. A hollow flat-faced punch should be used to stake the wheel down.

**D. HAZARDS IN ASSEMBLY OF WHEEL OVER FOURTH WHEEL:**

Use care in staking down this wheel so that you do not bend or break the fourth wheel pivot. If movement is held level, the hazards in replacing this wheel will be eliminated.

**E. FUNCTION OF WHEEL OVER FOURTH WHEEL:**

The function of this wheel is to transmit the power from the train of the watch to the chronograph mechanism. This wheel continues to turn as long as the watch is running.

**REMARKS: - - IMPORTANT**

At this place the seconds wheel tension spring, Assembly No. 43, should be adjusted to hold its proper tension on the seconds wheel. This spring is controlled by adjustment screw AS-2, as shown on the photograph. When adjustment screw AS-2 is loosened, the seconds wheel tension spring will increase its tension on the seconds wheel. When the adjustment screw AS-2 is screwed down, the seconds wheel tension spring will lighten its tension on the seconds wheel. The seconds wheel tension spring should hold as light a tension on the seconds wheel as possible and still eliminate any jerky or irregular turning of the seconds wheel when the chronograph is engaged.

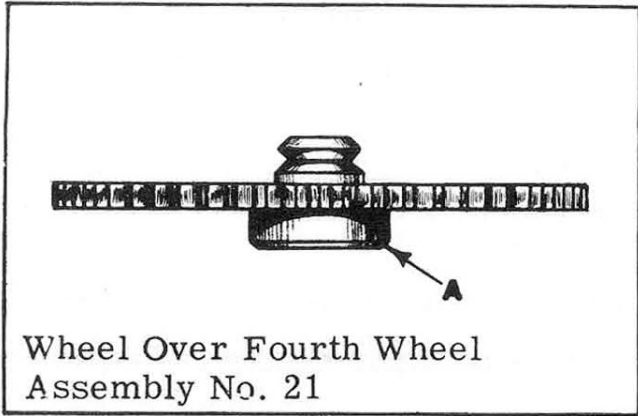

OILING

The wheel over fourth wheel should not be oiled.



21-A

**A. DISASSEMBLY PROCEDURE OF CHRONOGRAPH PIVOTED DETENT SPRING:**

This spring is held in place by beveled countersink screw BS-8, and a steady pin. Remove screw, and steady pin will be free in plate, and the detent spring may be lifted from the movement.

(The shape of screw for this part is shown at the bottom of the page.)

**B. ASSEMBLY PROCEDURE OF CHRONOGRAPH PIVOTED DETENT SPRING:**

Place the spring in position on the plate, with steady pin in proper hole. End "A" of spring should be on lip "A" of the chronograph pivoted detent. Re-place beveled countersink screw BS-8 that holds this spring in place.

**C. FUNCTION OF CHRONOGRAPH PIVOTED DETENT SPRING:**

The functions of this spring are:

1. It holds a tension on the chronograph pivoted detent, forcing it in the direction to engage the intermediary wheel with the seconds wheel.
2. It helps to hold the chronograph pivoted detent down in position on the plate, preventing it from riding up.

**REMARKS:**

The tension of the chronograph pivoted detent spring on the chronograph pivoted detent must be strong enough to engage the intermediary wheel with the seconds wheel. Any excess tension makes it unnecessarily hard for the castle wheel to disengage the intermediary wheel from the seconds wheel.

At this point, the intermediary wheel should be checked to see that it will not rise enough to be out of mesh with seconds wheel.

The endshake of the intermediary wheel, plus the vertical movement or endshake of chronograph pivoted detent under the screw-head that holds it in place, should not be enough to permit the intermediary wheel to rise enough to be out of mesh with the seconds wheel.

**REFERENCE:** Chronograph pivoted detent is Assembly 25.  
Seconds wheel is Assembly 42.  
Intermediary wheel is Assembly 24.

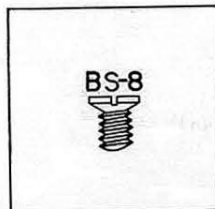



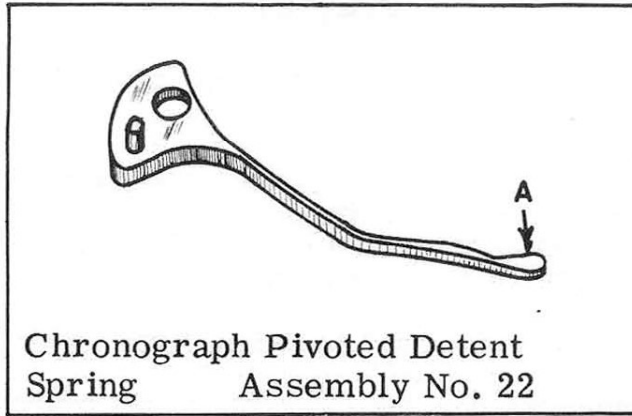

Chronograph Pivoted Detent  
Spring      Assembly No. 22

#### OILING

End "A" on chronograph pivoted detent spring should be slightly moistened with oil at point of contact with chronograph pivoted detent.



TRAIN SIDE

22-A

**A. DISASSEMBLY PROCEDURE OF CHRONOGRAPH PIVOTED DETENT BRIDGE:**

This bridge is held in place by fillister head screw FS-6 and steady pins. Remove screw and loosen bridge from chronograph pivoted detent, by sliding a thin blade screwdriver under bridge. When steady pins are free in detent, bridge may be lifted out of place.

(The shape of screw for this part is shown at the bottom of page.)

**B. HAZARDS IN DISASSEMBLY OF CHRONOGRAPH PIVOTED DETENT BRIDGE:**

When using a screwdriver to loosen bridge from detent, care should be taken to keep bridge level, as any twisting may damage pivot on intermediary wheel or burr the bushing in bridge or pivoted detent. The screwdriver should be carefully used to prevent marring of bridge or detent.

**C. ASSEMBLY PROCEDURE OF CHRONOGRAPH PIVOTED DETENT BRIDGE:**

Place bridge on chronograph pivoted detent with steady pins over proper holes in detent. Place intermediary wheel so that pivot on this wheel will enter bushing in bridge. Bridge may now be pressed down to proper place with back of tweezers, and fillister head screw FS-6 replaced in bridge.

**D. HAZARDS IN ASSEMBLY OF CHRONOGRAPH PIVOTED DETENT BRIDGE:**

Keep bridge level when pressing down to proper place, as any twisting may burr the bushing in the bridge or damage the pivot on intermediary wheel. The bridge and detent, where these two parts come together, should be checked to see that there are no burrs which would prevent the bridge from setting properly on chronograph pivoted detent. At this point it is advisable to check the intermediary wheel to see that it has proper endshake. Also, check to see that it spins freely.

**E. FUNCTION OF CHRONOGRAPH PIVOTED DETENT BRIDGE:**

The function of this bridge is to provide a bearing surface for the top pivot of the intermediary wheel; also, it connects the chronograph pivoted detent to the castle wheel.

**REFERENCE:** Chronograph pivoted detent is Assembly 25.  
Intermediary wheel is Assembly 24.

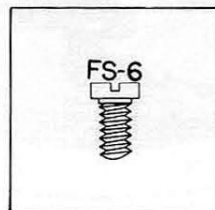

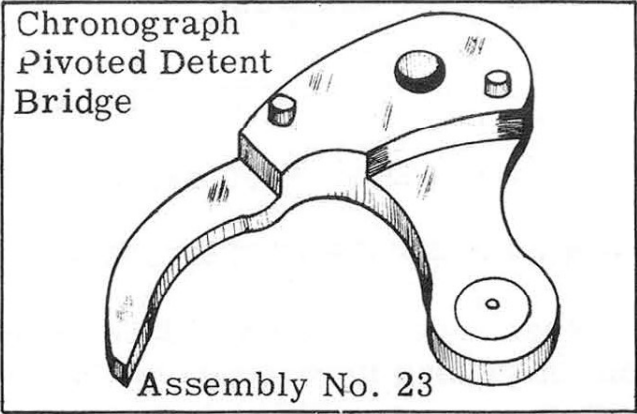

### OILING

The pivot in bushing hole in this bridge should be oiled as you usually oil a train pivot in a watch.



23-A

**A. DISASSEMBLY PROCEDURE OF INTERMEDIARY WHEEL:**

To remove the intermediary wheel, simply lift it out of place.

**B. ASSEMBLY PROCEDURE OF INTERMEDIARY WHEEL:**

The end "A" of staff should be up. Place the bottom pivot "B" of staff in hole in bushing in chronograph pivoted detent.

**C. HAZARDS IN ASSEMBLY OF INTERMEDIARY WHEEL:**

Pivot hole in bushing in chronograph pivoted detent should be carefully examined before replacing intermediary wheel. Any imperfection here will affect the timekeeping of the watch, and hinder the proper operation of the chronograph.

**D. FUNCTION OF INTERMEDIARY WHEEL:**

The function of the intermediary wheel is to transfer the power from the wheel over fourth wheel to the seconds wheel, when these wheels are engaged. The intermediary wheel continues to turn as long as the watch is running.

**REMARKS:**

A careful and detailed examination should be made of all wheels before replacing in the chronograph. Each wheel should be examined for burred pivots, bent or burred teeth, dirt or small pieces of grit wedged between the teeth.

When the VEE shaped teeth of one wheel mesh into the VEE shaped teeth of another wheel, there is very little clearance between the teeth. Because of this, even the smallest piece of grit or dirt wedged into one of these teeth, may stop the chronograph. The intermediary wheel has VEE shaped teeth.

**REFERENCE:** Chronograph pivoted detent is Assembly 25.  
Seconds wheel is Assembly 42.  
Wheel over fourth wheel is Assembly 21.

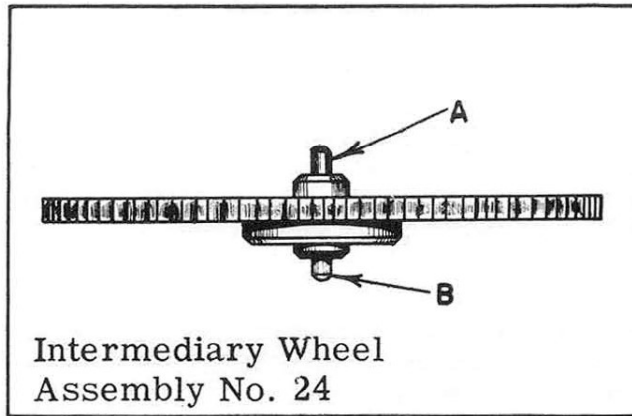

### OILING

The bottom pivot on intermediary wheel should be oiled before placing this wheel in chronograph pivoted detent. The top pivot is oiled after bridge for this wheel is replaced.



TRAIN SIDE

24-A

**A. DISASSEMBLY PROCEDURE OF CHRONOGRAPH PIVOTED DETENT:**

This detent is held in place by shouldered screws SS-4 and SS-5, and pivots on an eccentric stud. After these screws are removed, the detent may be lifted from eccentric stud and free of movement. The position of shouldered screws SS-4 and SS-5, is shown on the photograph.

**REMARKS:**

The shouldered screw SS-4 at this time does not necessarily have to be removed unless it actually holds the chronograph pivoted detent down preventing the detent from being removed.

It can be seen on the photograph that the particular type chronograph pivoted detent shown, does not extend under the shouldered screw SS-4, thus making it unnecessary to remove this screw at this time.

Many times, however, there is another type of chronograph pivoted detent used in this model chronograph with the end "B" of the detent extending under the shouldered screw SS-4, thus making it necessary to remove this screw at this time.

(The shape of screws for this part is shown at the bottom of page.)

**B. ASSEMBLY PROCEDURE OF CHRONOGRAPH PIVOTED DETENT:**

Place the detent on the plate, with hole in end of detent over eccentric stud, as detent pivots on this stud. When detent is in place, shouldered screws SS-4 and SS-5 should be replaced. Detent must move freely under the head of these screws. The position of these screws is shown on the photograph.

After replacing detent, check to see that it has enough freedom to move freely under the heads of shouldered screws, and yet does not have excess freedom.

**C. FUNCTION OF CHRONOGRAPH PIVOTED DETENT:**

1. The chronograph pivoted detent provides a bearing surface for the lower pivot of the intermediary wheel.
2. The chronograph pivoted detent with the chronograph pivoted detent bridge (chronograph pivoted detent bridge will be assembled later), controls the engaging and disengaging of the intermediary wheel with the seconds wheel.

**REFERENCE:** Intermediary wheel is Assembly 24.  
Seconds wheel is Assembly 42.  
Chronograph pivoted detent bridge is Assembly 23.

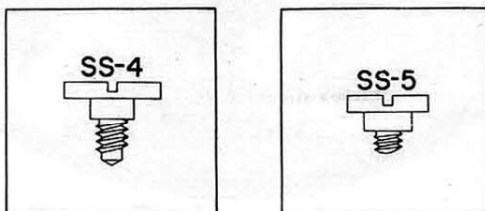

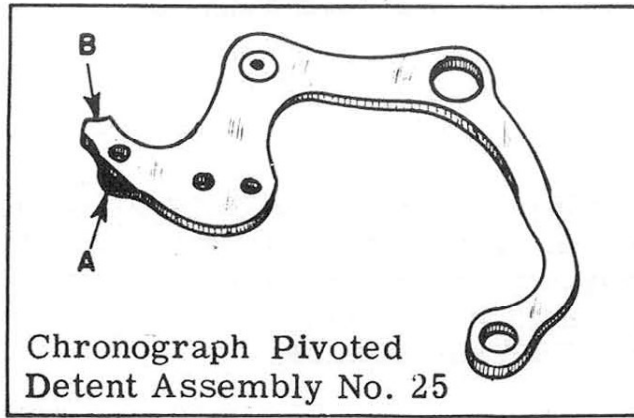

### OILING

The eccentric stud, that the chronograph pivoted detent pivots on, should be slightly moistened with oil.



25-A

**A. DISASSEMBLY PROCEDURE OF ACTUATING DETENT LEVER SPRING:**

This spring is held in place by beveled countersink screw BS-9 and a steady pin. After screw has been removed, the spring may be loosened from plate by sliding a thin blade screwdriver between plate and spring. When steady pin is free in plate, this spring can be lifted out of place.

**NOTE:**

You will notice this spring sets on top of a small plate, shown as "B" in the isometric drawing. This small plate holds the spring above the level of the movement plate.

(The shape of screw for this part is shown at bottom of page.)

**B. ASSEMBLY PROCEDURE OF ACTUATING DETENT LEVER SPRING:**

Place this spring in its proper position on the movement, as shown on the photograph. The steady pin on spring must pass through the plate "B" into the proper hole in the movement. Now press this spring down to proper place. Before replacing screw, make sure the end "A" is in contact with the pin "C" on joint hook, as shown on the photograph. Beveled countersink screw BS-9 can now be replaced.

**C. FUNCTION OF ACTUATING DETENT LEVER SPRING:**

The functions of this spring are:

1. It holds the joint hook in towards the center of the watch.
2. It holds a tension on joint hook holding it engaged with the ratchet teeth on the castle wheel.
3. It helps hold joint hook down flush on plate.

**REFERENCE:** Actuating Detent Lever and Joint Hook is Assembly 27.

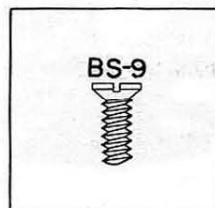



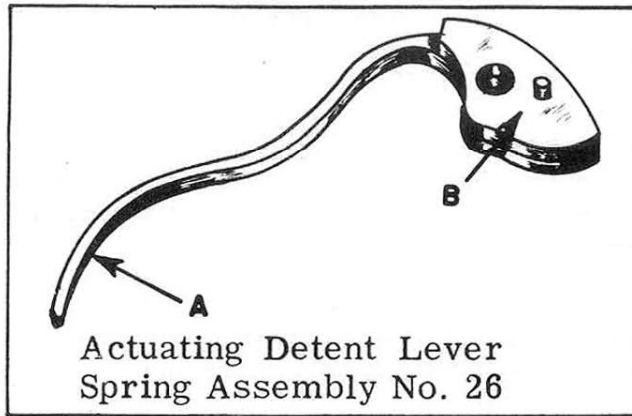

Actuating Detent Lever  
Spring Assembly No. 26

### OILING

End "A" on actuating detent lever spring should be slightly moistened with oil at point of contact with pin "C" on joint hook.



TRAIN SIDE

26-A

A. DISASSEMBLY PROCEDURE OF ACTUATING DETENT LEVER AND JOINT HOOK:

The actuating detent lever is held in place by shouldered screw SS-6, and pivots on this screw. When screw has been removed, detent lever may be lifted from movement.

If the shouldered screw SS-4, as shown on the photograph, has not been removed with the chronograph pivoted detent, it should be removed now, as this screw helps hold the joint hook down in place.

NOTE: The joint hook is held to the actuating detent lever by shouldered screw SS-7. To remove the joint hook from the actuating detent lever, remove shouldered screw SS-7. This will free the joint hook from the actuating detent lever.

(The shape of screws for this part is shown at the bottom of page.)

B. ASSEMBLY PROCEDURE OF ACTUATING DETENT LEVER AND JOINT HOOK:

Place the joint hook on the actuating detent lever and replace shouldered screw SS-7 that holds the joint hook to the actuating detent lever. Check joint hook to see that it pivots freely under head of screw. Now replace the actuating detent lever and joint hook in proper position on plate, as shown on the photograph. Before replacing screw, be sure that joint hook is not on top of the ratchet teeth on the castle wheel. The joint hook should mesh into the ratchet teeth on this wheel. When actuating detent lever and joint hook are in proper position, replace shouldered screw SS-6. The actuating detent should be checked to see that it pivots freely under the head of this screw.

C. FUNCTION OF ACTUATING DETENT LEVER AND JOINT HOOK:

The function of the actuating detent lever and joint hook is to turn the castle wheel one tooth each time the end "B" of actuating detent is pushed.

REMARKS:

The joint hook should be carefully examined for any burrs or roughness that may cause it not to function properly. The end "A" of joint hook should be highly polished, as any burrs or roughness may cause the joint hook not to engage properly with the ratchet teeth. When polishing this part, care should be taken that shape of hook is not changed.

REFERENCE: Chronograph pivoted detent is Assembly 25.  
Castle wheel is Assembly 38.

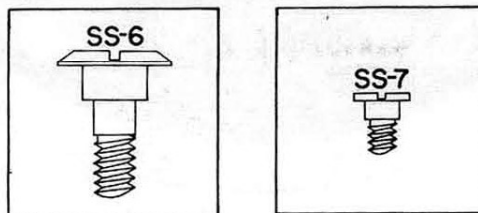

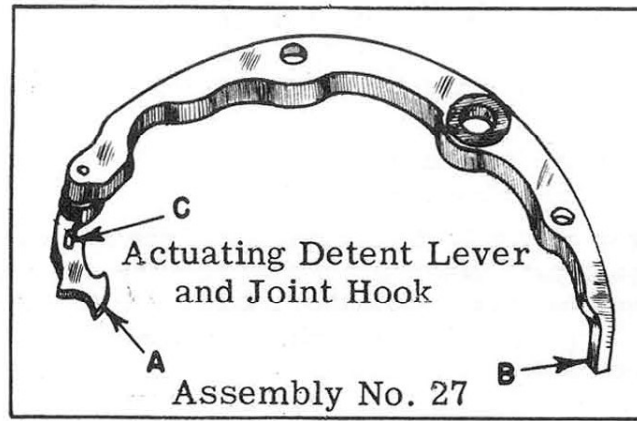

### OILING

These two points on actuating detent lever and joint hook should be slightly moistened with oil:

1. Shoulder of screw that actuating detent pivots on.
2. Shoulder of screw that joint hook pivots on.



27-A

**A. DISASSEMBLY PROCEDURE OF FLYBACK LEVER SPRING:**

(Before removing this spring, make sure the flyback lever is in the position as shown on the photograph.)

The flyback lever spring is held in place by beveled countersink screw BS-10 and a steady pin. When this screw is removed, this spring can be loosened from the plate by sliding a thin blade screwdriver between the spring and the plate. After steady pin is free in hole in plate, this spring can be lifted out of place.

(The shape of screw for this part is shown at the bottom of page.)

**B. ASSEMBLY PROCEDURE OF FLYBACK LEVER SPRING:**

Before replacing this spring, make sure that the flyback lever is in the position shown on the photograph. When this is done, place this spring in its proper position on the plate, with the steady pin in its proper hole. The end "A" of spring should be hooked between the screwhead "C" and the flyback lever. Now, with a piece of pegwood, force the spring at location "B" in the direction toward the center of the watch, so that the hole in the spring is directly over the screw hole in the plate. While holding the spring in this position, replace beveled countersink screw BS-10

**C. FUNCTION OF FLYBACK LEVER SPRING:**

The functions of this spring are:

1. It holds a tension on the flyback lever, forcing it toward the center of the watch.
2. It holds the flyback lever down in place, preventing it from riding up on post and coming out of place.

**REMARKS:**

When the flyback lever is released, the flyback lever spring must hold enough tension on flyback lever to force it toward the center of the watch, with enough pressure to return the seconds wheel and minute register wheel to a zero position.

**REFERENCE:** Flyback lever is Assembly 31.

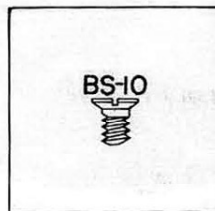

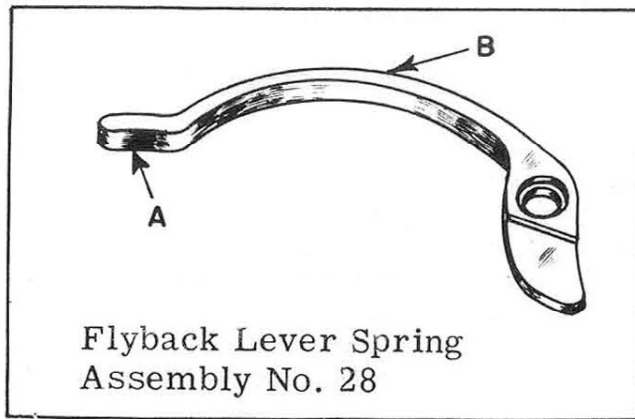

### OILING

End "A" on flyback lever spring should be slightly moistened with oil, at point of contact with flyback lever.



28-A

**A. DISASSEMBLY PROCEDURE OF PUSH PIECE FOR SETTING BACK TO ZERO SPRING:**

Grip end "A" of spring with a pair of stiff tweezers. Lift up, freeing it from the push piece for setting back to zero. After tension has been removed, it can be lifted from the hollow stud on the plate. When removing this spring, hold your finger over it to eliminate the hazard of it shooting away and becoming lost.

**B. ASSEMBLY PROCEDURE OF PUSH PIECE FOR SETTING BACK TO ZERO SPRING:**

Place end "B" of spring in its proper position on the plate, as shown on the photograph. Now grip end "A" of spring with a pair of stiff tweezers and force end "A" of spring in toward the center of the watch, hooking it on the inside of the push piece for setting back to zero. Hold finger over the end "B" of spring when forcing end "A" of spring towards the center of the watch, to eliminate the hazard of the spring shooting away and becoming lost.

**C. HAZARDS IN ASSEMBLY OF PUSH PIECE FOR SETTING BACK TO ZERO SPRING:**

To help eliminate the hazard of this spring shooting away, use a sturdy pair of tweezers when replacing this spring.

**D. FUNCTION OF PUSH PIECE FOR SETTING BACK TO ZERO SPRING:**

The function of this spring is to hold a tension on the push piece for setting back to zero, holding end "A" of push piece away from the center of watch.

**REMARKS:**

When adjusting springs for proper tension, it is good to follow this policy as a general rule.

1. A spring should just hold enough tension on a part to perform its function properly.
2. Any excess tension on a part in a chronograph mechanism will cause the chronograph to be harder to work, also causing more wear, etc.

Of course, the amount of pressure the spring should hold on a part is determined in the factory; because of this it is seldom that you should have to adjust a spring. However, you may have to make one of these springs, and the above rules should aid you in setting the proper tension.

**REFERENCE:** Push piece for setting back to zero is Assembly 30.

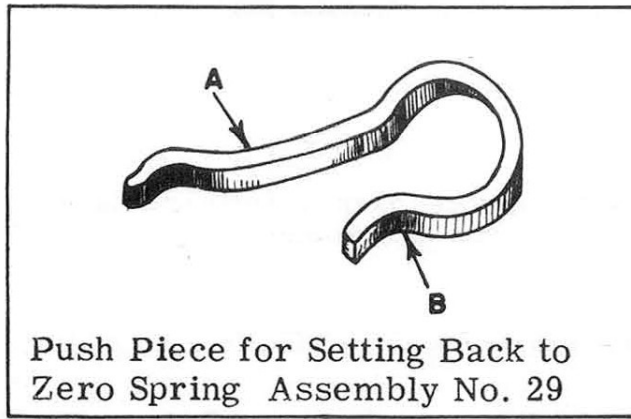

Push Piece for Setting Back to Zero Spring Assembly No. 29

### OILING

End "A" of push piece for setting back to zero spring should be slightly moistened with oil at point of contact with push piece for setting back to zero.



TRAIN SIDE

29-A

A. DISASSEMBLY PROCEDURE OF PUSH PIECE FOR SETTING BACK TO ZERO:

The push piece for setting back to zero pivots on a hollow stud in the plate. To remove push piece, simply lift it from the hollow stud.

B. ASSEMBLY PROCEDURE OF PUSH PIECE FOR SETTING BACK TO ZERO:

Place the push piece on the plate in the position shown on the photograph, with the hole in push piece over hollow stud in plate. The push piece should turn freely on the hollow stud.

C. FUNCTION OF PUSH PIECE FOR SETTING BACK TO ZERO:

The function of the push piece for setting back to zero is to unhook the flyback trip lever from the flyback lever, thus permitting the flyback lever to be forced towards the center of the watch.

REMARKS:

When the push piece for setting back to zero is pressed, this push piece contacts the flyback trip lever, forcing it to turn slightly. This unhooks the flyback trip lever from the pin on flyback lever.

NOTICE: If the head of a shouldered screw tightens down on a part, preventing it from functioning properly, the shoulder of the screw is shorter than the thickness of the lever. To correct this, the head of the shouldered screw must be cut back to lengthen the shoulder on the screw.

I do not want to give the impression that lengthening the shoulder on shouldered screw will always free a part under it; many times, it is the diameter of the shoulder that is causing the lever to be tight. Naturally, to correct this, the diameter of the shoulder must be cut down slightly for freedom.

REFERENCE: Flyback trip lever is Assembly 32.  
Flyback lever is Assembly 31.



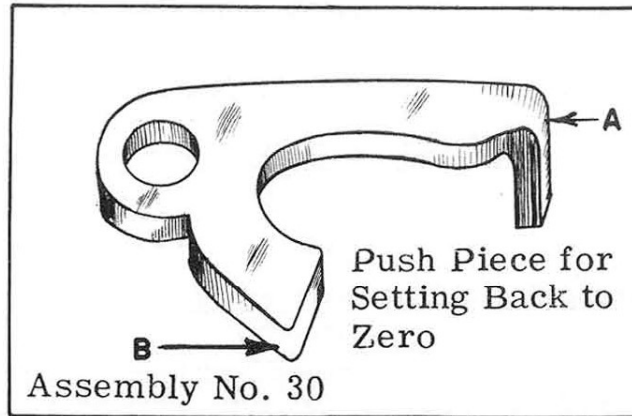

### OILING

These points on push piece for setting back to zero should be slightly moistened with oil:

1. The post that push piece pivots on.
2. Point "B" on push piece that contacts flyback trip lever.



30-A

**A. DISASSEMBLY PROCEDURE OF FLYBACK LEVER:**

To remove the flyback lever, move it to the position shown on the photograph. Then lift straight up on the lever, freeing it from the post on the plate.

**B. ASSEMBLY PROCEDURE OF FLYBACK LEVER:**

The flyback lever should be replaced with the screwhead "C" down. Now place the flyback lever in the position shown on the photograph, with the hole in bushing over post on plate. Now press the flyback lever down and make sure that the pin "D" on flyback lever is not on top of the flyback trip lever. If this pin sets on top of the flyback trip lever, move the flyback trip lever away from this pin, permitting the flyback lever to be pressed down further into place.

**C. FUNCTION OF FLYBACK LEVER:**

The functions of the flyback lever are:

1. The surface "F" of the flyback lever contacts the pin "C" on the intermittent lever and wheel assembly, forcing this assembly to disengage the intermittent wheel from the dart tooth.
2. The ends "A" and "B" of flyback lever contact the heart on the seconds wheel and minute register wheel, forcing these wheels to return to a zero position.
3. The pin "E" on flyback lever contacts the surface "C" on brake lever, disengaging the brake lever from seconds wheel.

**REMARKS:**

The flat ends "A" and "B" of flyback lever must be highly polished as any roughness or pits of rust at this location may cause the flyback lever not to function properly. When polishing these ends, care should be taken not to shorten one end more than the other or they will not function correctly, as described above.

**REFERENCE:** Flyback trip lever is Assembly 32.  
Seconds wheel is Assembly 42.  
Minute register wheel is Assembly 44.  
Brake lever is Assembly 34.  
Intermittent lever and wheel assembly is Assembly 45.

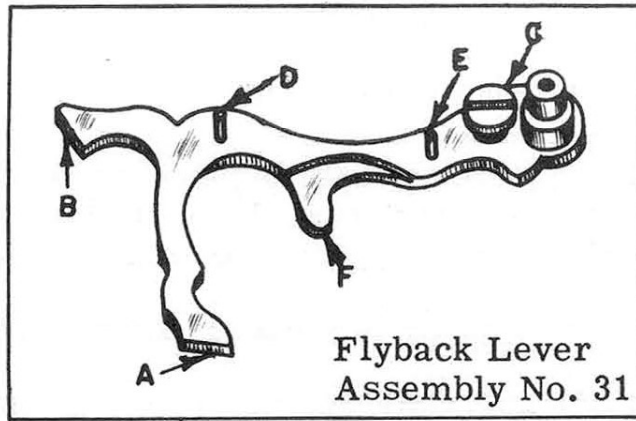

#### OILING

These points on flyback lever should be slightly moistened with oil:

1. Post on which flyback lever pivots.
2. Pin "D" at point of contact with flyback trip lever.
3. Pin "E" at point of contact with point "C" on brake lever.
4. Point "F" at point of contact with pin "C" on intermittent lever.

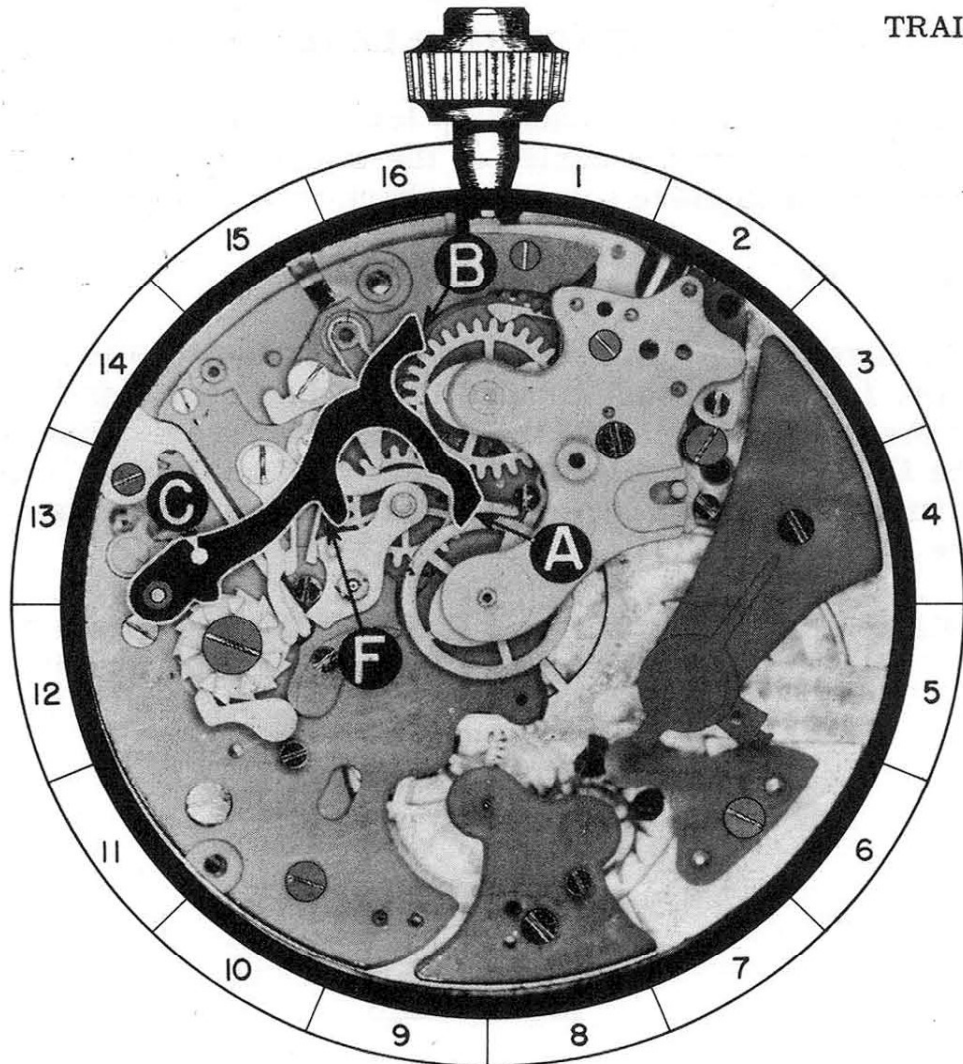

31-A

**A. DISASSEMBLY PROCEDURE OF FLYBACK TRIP LEVER:**

The flyback trip lever is held in place by shouldered screw SS-8 and pivots on this screw. When screw is removed, this trip lever will be free on plate, and may be lifted out of place.

(The shape of screw for this part is shown at bottom of page.)

**B. ASSEMBLY PROCEDURE OF FLYBACK TRIP LEVER:**

Place this lever on the plate, in the position shown on the photograph, with the pin "A" on the trip lever, on the outside surface "A" of the flyback trip lever spring. Now replace shouldered screw SS-8 to hold this part in place. The trip lever should pivot freely under the head of this screw.

**C. FUNCTION OF FLYBACK TRIP LEVER:**

The function of the flyback trip lever is to hold the flyback lever away from the center of the watch and then release it, when the push piece for setting back to zero is pushed.

**REMARKS:**

The flyback trip lever is controlled manually. When the push piece for setting back to zero is pushed in towards the center of the watch, it contacts the flyback trip lever. This unlocks the flyback trip lever from the pin "D" on flyback lever, permitting the flyback lever to be forced towards the center of the watch.

**REFERENCE:** Flyback trip lever spring is Assembly 33.  
Push piece for setting back to zero is Assembly 30.

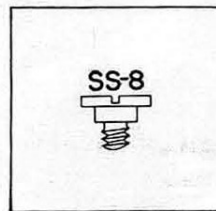

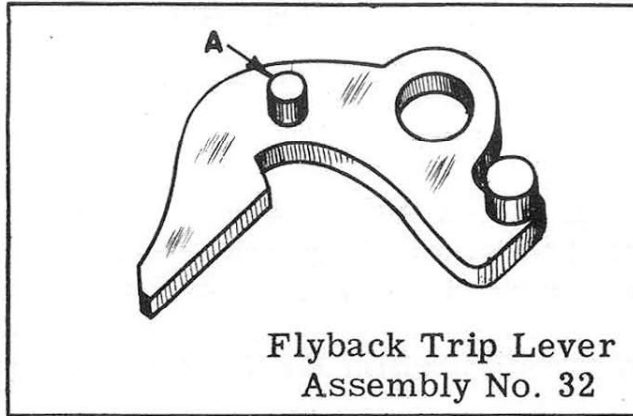

#### OILING

The flyback trip lever should be slightly moistened with oil at these points:

1. Shoulder of screw that flyback trip lever pivots on.
2. Pin "A" that contacts flyback trip lever spring.

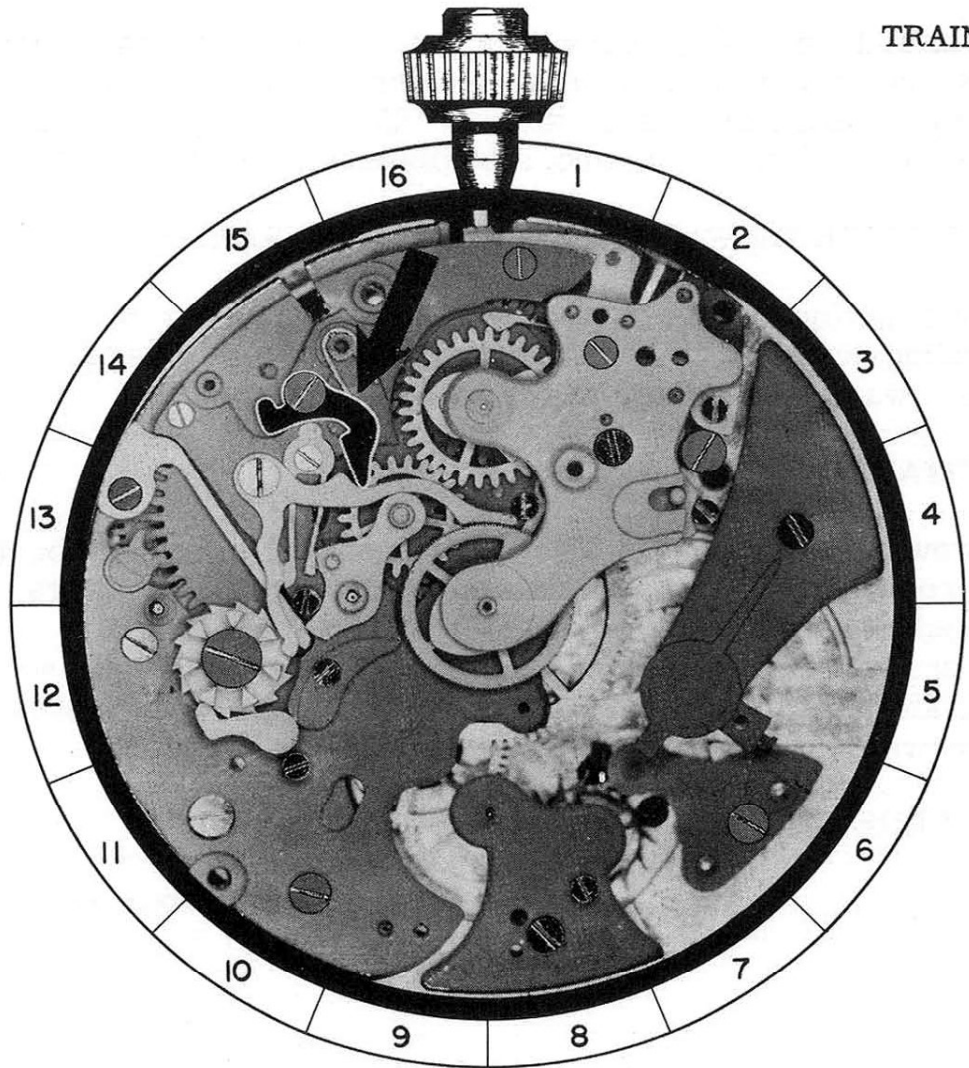

32-A

**A. DISASSEMBLY PROCEDURE OF FLYBACK TRIP LEVER SPRING:**

Grip end "A" of spring with a pair of tweezers, and lift up on spring. In doing this, hold finger over spring, to eliminate the hazard of the spring shooting away and becoming lost.

**B. HAZARDS IN DISASSEMBLY OF FLYBACK TRIP LEVER SPRING:**

This spring is very delicate, and care should be taken not to bend this spring in any way.

**C. ASSEMBLY PROCEDURE OF FLYBACK TRIP LEVER SPRING:**

Grip end "A" of spring with a pair of tweezers and place end "B" of spring in its proper position, as shown on the photograph. Hold finger over the end "B" of the spring, and force the end "A" down in recess in plate with tweezers.

**D. FUNCTION OF FLYBACK TRIP LEVER SPRING:**

The function of this spring is to hold the flyback trip lever in a locking position, that will prevent the flyback lever from moving towards the center of the watch.

**REMARKS:**

I would like to remind the repairer that it is important, that in removing these parts, the screwdriver and tweezers should be sharpened correctly and the correct size of screwdriver blade used for each screw slot. This will eliminate a lot of unnecessary breakage, marring of plates or screws, and loss of parts.

**REFERENCE:** Flyback trip lever is Assembly 32.  
Flyback lever is Assembly 31.  
Push piece for setting back to zero is Assembly 30.

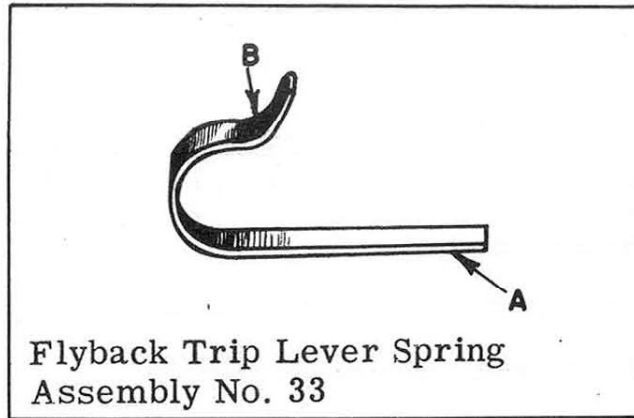

### OILING

The flyback trip lever spring should not be oiled until the next part is assembled.

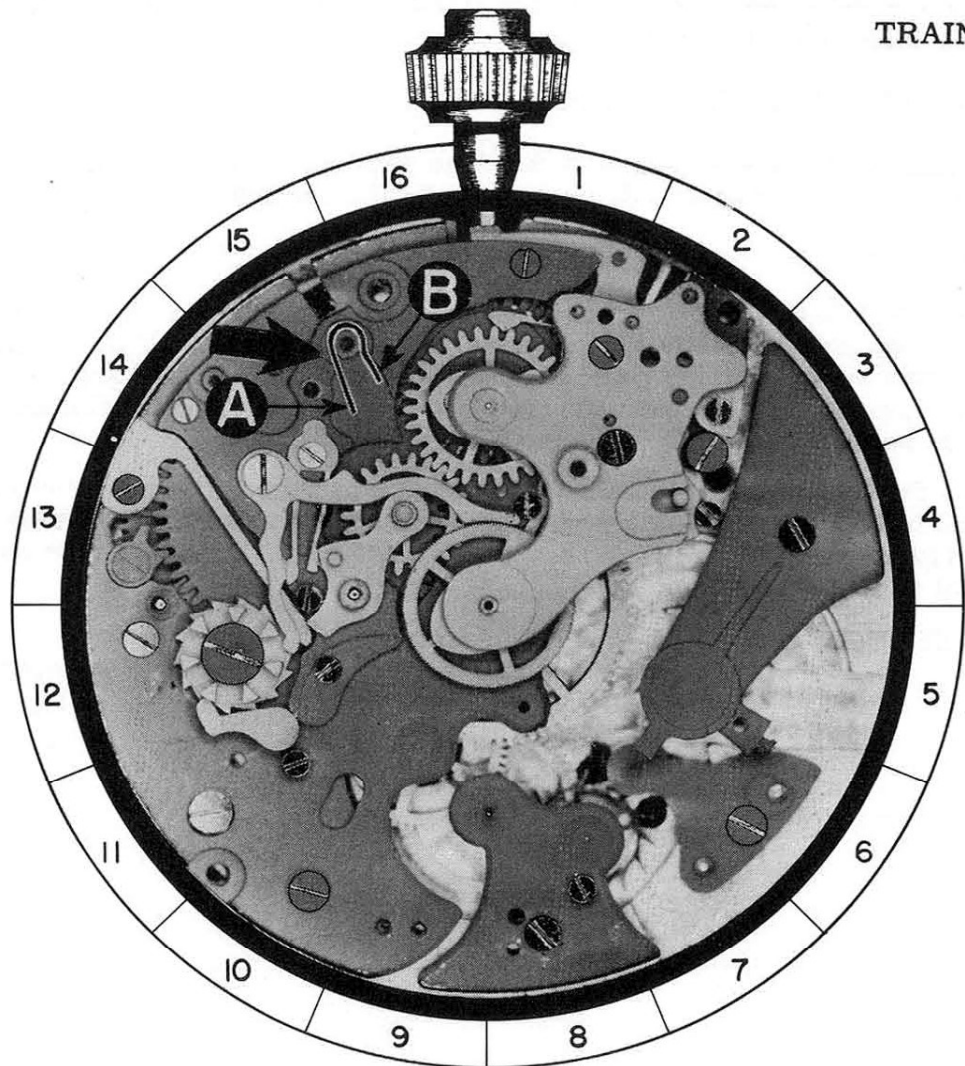

33-A

**A. DISASSEMBLY PROCEDURE OF BRAKE LEVER:**

This brake lever is held in place by shouldered screw SS-9, and pivots on this screw. After this screw has been removed, do not lift straight up on brake lever, but slide the lip "A" on it from under the brake lever and intermittent lever spring.

(The shape of screw for this part is shown at the bottom of page.)

**B. HAZARDS IN DISASSEMBLY OF BRAKE LEVER:**

Hold finger over lever when removing screw, so that screw does not shoot away and become lost.

**C. ASSEMBLY PROCEDURE OF BRAKE LEVER:**

Place the brake lever on the plate in its proper position. The lip "A" on the brake lever should fit under end "B" of brake lever and intermittent lever spring. Now place hole in brake lever over proper hole in plate, and replace shouldered screw SS-9. Check the brake lever to see that it pivots freely under the head of this screw.

**D. FUNCTION OF BRAKE LEVER:**

Function of the brake lever is to hold the seconds wheel stationary, when the intermediary wheel is disengaged from the seconds wheel.

**REMARKS:**

When the flyback lever is brought towards the center of the watch, pin "E" on flyback lever contacts the surface "C" on brake lever. This disengages the brake lever from the seconds wheel. Naturally, the brake lever must be disengaged from the seconds wheel at this time, so that the flyback lever can bring the seconds wheel back to zero position.

When the castle wheel is turned to a position to permit the intermediary wheel to engage with the seconds wheel, the castle wheel, at the same time, disengages the brake lever from the seconds wheel. This frees the seconds wheel so that it can turn.

**REFERENCE:** Seconds wheel is Assembly 42.  
Brake lever and intermittent lever spring is Assembly 35.  
Intermediary wheel is Assembly 24.  
Flyback lever is Assembly 31.

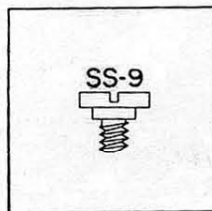



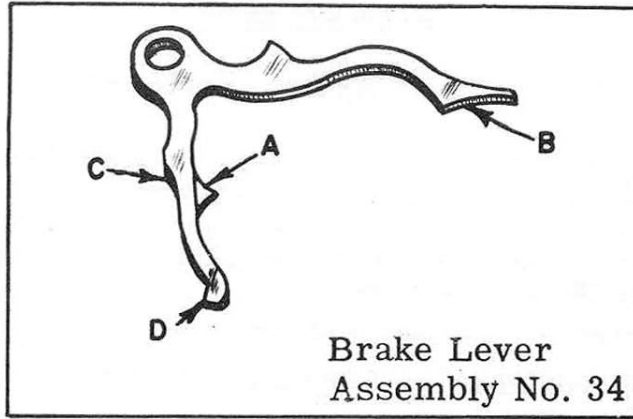

#### OILING

The brake lever should be slightly moistened with oil at these points:

1. The shoulder of screw on which brake lever pivots.
2. Point "A" that contacts end "B" on brake lever spring.

TRAIN SIDE



34-A

**A. DISASSEMBLY PROCEDURE OF BRAKE LEVER AND INTERMITTENT LEVER SPRING:**

This spring is held in place by fillister head screw FS-7 and a recess in the plate. To remove this spring, remove fillister screw FS-7, and slide a finely sharpened screwdriver under the base of the spring, loosening it from the recess in the plate. After the spring is free on the plate, the spring can be lifted out of place.

(The shape of screw for this part is shown at bottom of page.)

**C. HAZARDS IN DISASSEMBLY OF BRAKE LEVER AND INTERMITTENT LEVER SPRING:**

This spring is very delicate and can be very easily damaged. If the shape of this spring is changed in any way, this spring may not function properly.

**C. ASSEMBLY PROCEDURE OF BRAKE LEVER AND INTERMITTENT LEVER SPRING:**

Place the brake lever and intermittent lever spring in its proper position on plate, as shown on the photograph. This spring fits down in the recess in the plate. Place the end "A" of this spring on the lip "A" of the intermittent lever and wheel assembly. Now replace fillister head screw FS-7, that holds this spring in place.

**D. HAZARDS IN ASSEMBLY OF BRAKE LEVER AND INTERMITTENT LEVER SPRING:**

When replacing this spring, care should be taken not to bend this spring in any manner, as this may cause the spring not to function properly.

**E. FUNCTION OF BRAKE LEVER AND INTERMITTENT LEVER SPRING:**

The functions of this spring are as follows:

1. This spring holds a tension on intermittent lever and wheel assembly to engage the intermittent wheel with the seconds wheel dart tooth. Also, it holds the intermittent lever down on post, preventing it from riding up and coming out of place.
2. It holds end "D" of brake lever in contact with the castle wheel.
3. It holds a tension on the brake lever, forcing end "B" to contact the seconds wheel when the brake lever is not disengaged by the castle wheel.

(At this point the brake lever has not been assembled.)

REFERENCE: Brake lever is Assembly 34.

Castle Wheel is Assembly 38.

Intermittent lever and wheel assembly is Assembly 45.

Seconds wheel is Assembly 42.

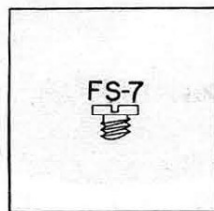

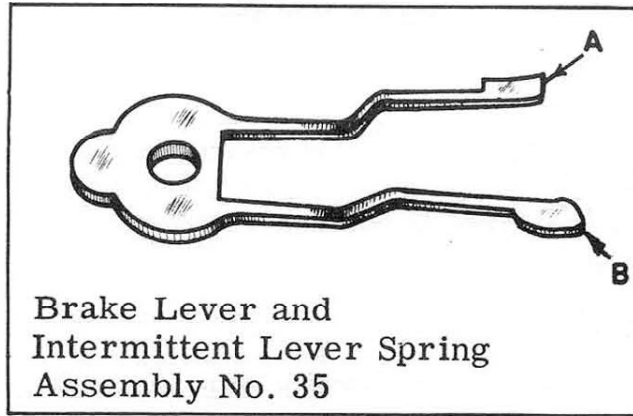

**OILING**  
End "A" on brake lever and intermittent lever spring should be slightly moistened with oil at point of contact with intermittent lever.

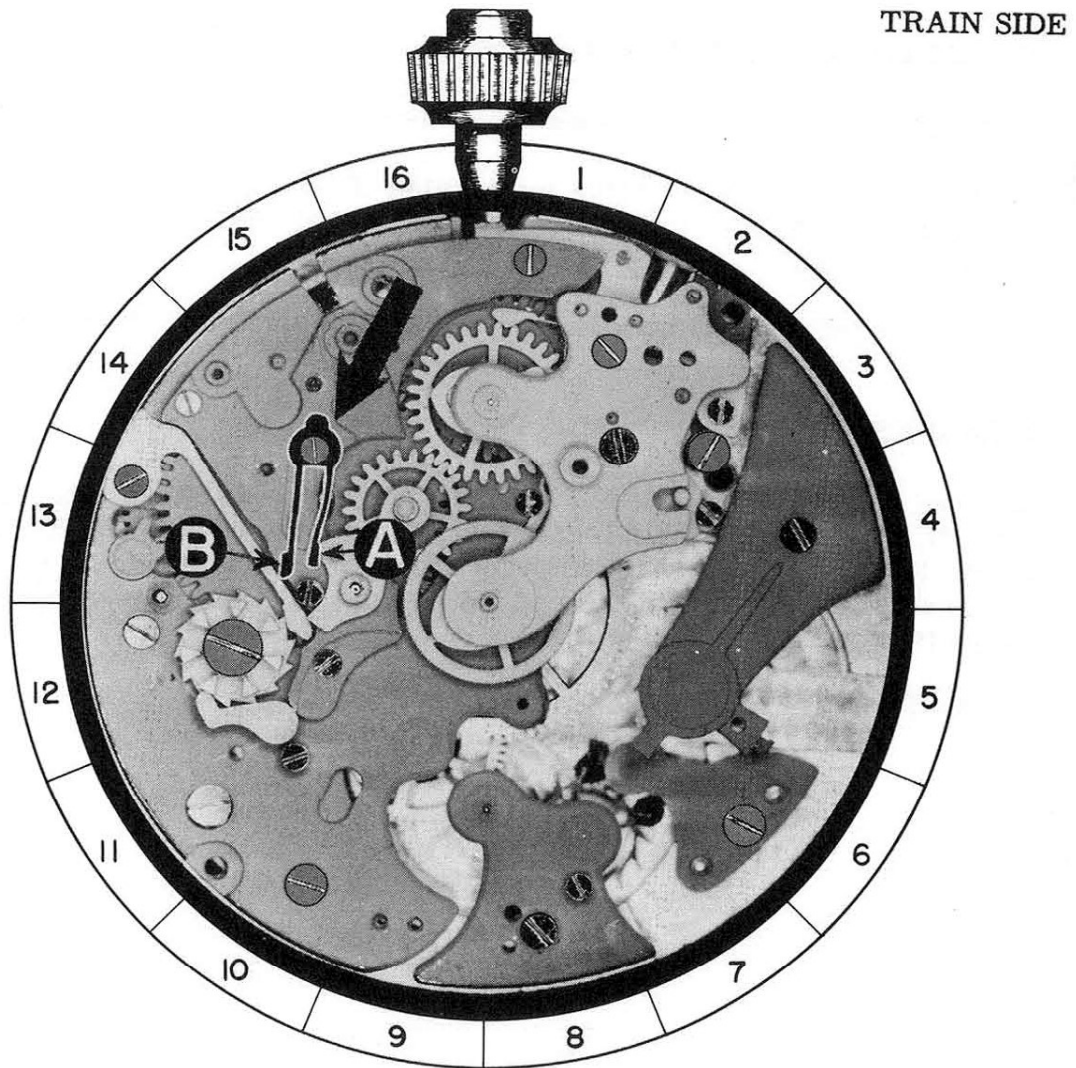

**A. DISASSEMBLY PROCEDURE OF CASTLE WHEEL PAWL:**

This pawl is held in place by beveled countersink screw BS-11 and a steady pin. When this screw is removed, pawl can be loosened from plate by sliding a thin blade screwdriver between pawl and plate. After steady pin is free in plate, pawl can be lifted out of place.

(The shape of screw for this part is shown at bottom of page.)

**B. ASSEMBLY PROCEDURE OF CASTLE WHEEL PAWL:**

Place pawl in its proper position on plate, with steady pin in proper hole in plate. Now press pawl down flush on plate. Make sure that end "A" of pawl is not on top of the ratchet teeth on the castle wheel but meshing in between two of the teeth on this wheel. To function properly, the end "A" of pawl must be engaged with the ratchet teeth on castle wheel. Now, replace beveled countersink screw BS-11 that holds this pawl in place.

**C. FUNCTION OF CASTLE WHEEL PAWL:**

The functions of the castle wheel pawl are as follows:

1. This pawl correctly spaces the turning of the castle wheel. This eliminates the possibility of the castle wheel setting at an incorrect position.
2. It holds the castle wheel in correct position until it is moved manually.

**REMARKS:**

The end "A" of castle wheel pawl must be highly polished. Any roughness or pits of rust at this location may cause the pawl not to function properly. If it is necessary to polish this part, care should be taken not to change the shape of the end "A" of pawl. It must be of correct shape to properly space the turning of the castle wheel.

**REFERENCE:** Castle wheel is Assembly 38.

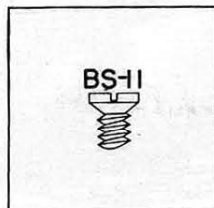

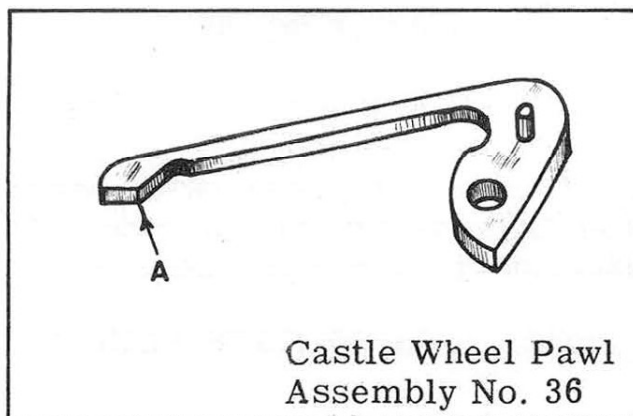

OILING

The castle wheel pawl should not be oiled.



36-A

**A. DISASSEMBLY OF HOUR REGISTER SWITCH LEVER:**

The long post of the hour register switch lever fits through movement from train side to the dial side. To remove this part, lift it straight up out of hole and free from movement.

**B. ASSEMBLY PROCEDURE OF HOUR REGISTER SWITCH LEVER:**

Place the long post of hour register switch lever down in the proper hole in bridge and plate. When the long post is entirely down, the rectangular end "A" will raise slightly above the surface of the pillar plate on the dial side. End "B" should contact columns "A" on castle wheel.

**C. FUNCTION OF HOUR REGISTER SWITCH LEVER:**

The function of the hour register switch lever is to engage and disengage the hour register mechanism. This lever is controlled by the castle wheel.

**REMARKS:**

The long post on the hour register switch lever will be held in the plate temporarily by the joint hook which will be replaced later in the assembly of this train side. When the parts on the dial side are assembled, the hour driving lever Assembly No. 10, will be held to the long post on switch lever by a screw. This will hold the hour switch lever in position, so it will function properly.

**REFERENCE:** Castle wheel is Assembly 38.  
Joint hook is Assembly 27.

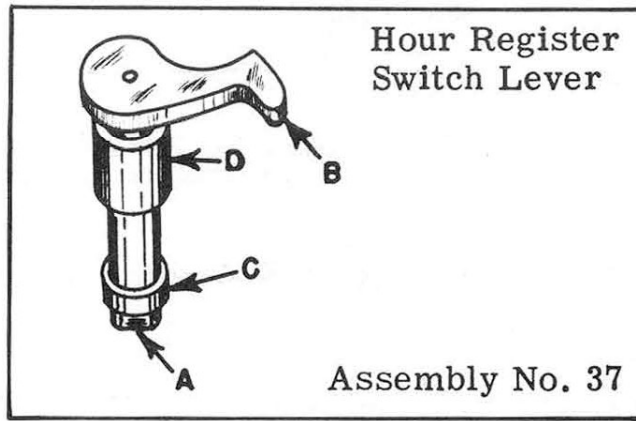

**OILING**

The post of hour register switch lever should be slightly moistened with oil on surfaces "C" and "D" that are in contact with bearing surfaces of bridge and plate.

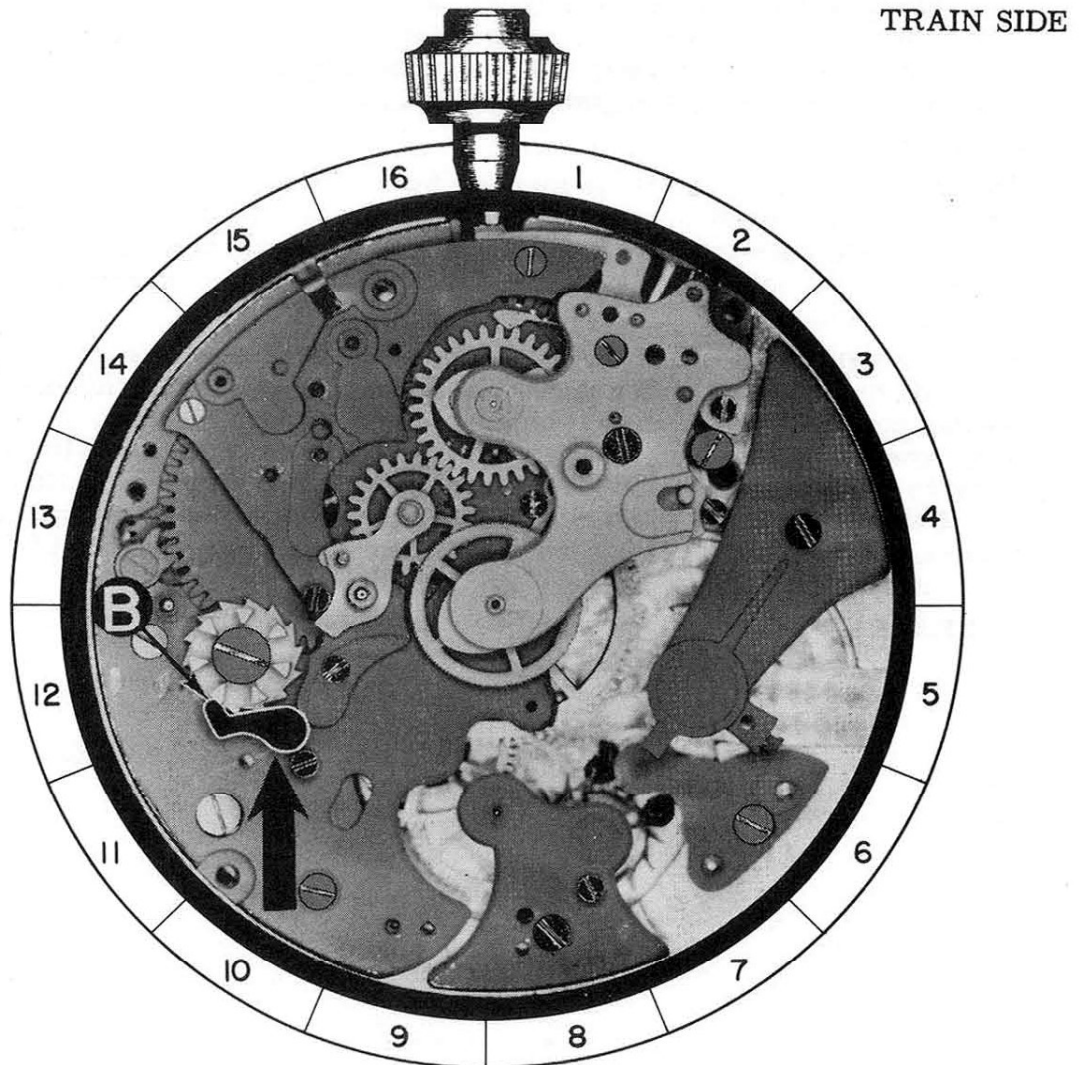

37-A

**A. DISASSEMBLY PROCEDURE OF CASTLE WHEEL:**

The castle wheel is held in place by shouldered screw SS-10. After this screw is removed, the castle wheel will be free on the plate and can be lifted out of place.

(The shape of screw for this part is shown at bottom of page.)

**B. ASSEMBLY PROCEDURE OF CASTLE WHEEL:**

Place the castle wheel in its proper position on plate, as shown on the photograph. Replace shouldered screw SS-10, that holds this wheel in place. Check to see that the wheel turns freely under the head of this screw. Of course, this wheel should not have excessive freedom.

**C. FUNCTION OF CASTLE WHEEL:**

The functions of the castle wheel are:

1. It disengages the intermediary wheel from the seconds wheel.
2. It disengages the brake lever from the seconds wheel.
3. It prevents the flyback lever from being moved towards the center of watch, when the chronograph mechanism is engaged.
4. It disengages the hour register mechanism.

**REMARKS:**

The castle wheel performs its function by the "columns" "A" which are evenly spaced around the center of the wheel. As the castle wheel is turned, the column either forces a part to move out from the center of the castle wheel, or permits it to move into the empty space between the two columns.

For example: the intermediary wheel is disengaged from the seconds wheel by the columns of the castle wheel, forcing the end of chronograph pivoted detent bridge from between the columns, until the point of this lever rests on the column. To engage the intermediary wheel with the seconds wheel, the castle wheel is turned one space. This permits the end of the chronograph pivoted detent bridge to enter the empty space between the columns, which permits the two wheels to be engaged by the chronograph pivoted detent.

**REFERENCE:** Intermediary wheel is Assembly 24.

Seconds wheel is Assembly 42.

Flyback lever is Assembly 31.

Brake lever is Assembly 34.

Chronograph pivoted detent bridge is Assembly 23.

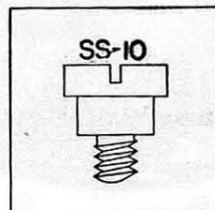



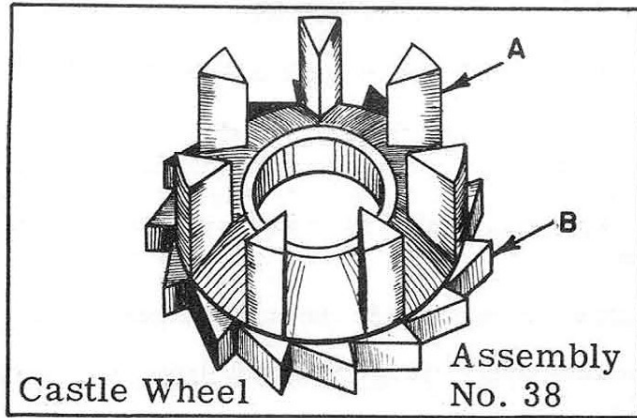

**OILING**

These points on castle wheel should be slightly moistened with oil:

1. The shoulder of screw that castle wheel pivots on.
2. The columns "A" that contact the parts of this mechanism.
3. The ratchet teeth "B".

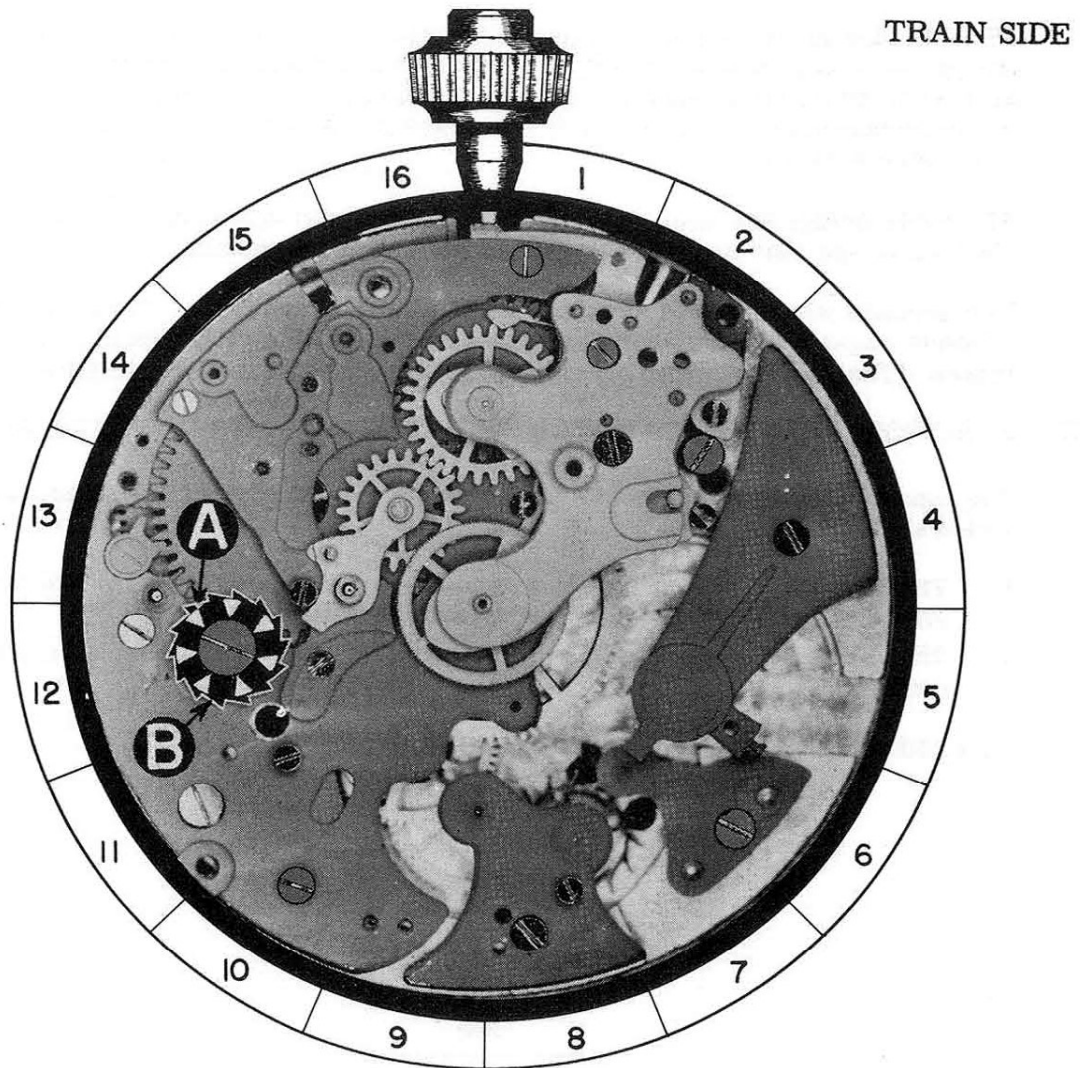

38-A

**A. DISASSEMBLY PROCEDURE OF SECONDS WHEEL AND MINUTE REGISTER WHEEL BRIDGE:**

This bridge is held in place by fillister head screw FS-8 and steady pins. Remove screw, and slide a thin blade screwdriver under bridge to loosen it from the plate. When steady pins are free in the plate, the bridge can be lifted out of place.

(The shape of screw for this part is shown at bottom of page.)

**B. HAZARDS IN DISASSEMBLY OF SECONDS WHEEL AND MINUTE REGISTER WHEEL BRIDGE:**

When loosening bridge from plate, be sure to keep bridge level. Any twisting of bridge may burr pivots on seconds wheel or minute register wheel or may chip the jewels in bridge. Also be careful not to mar the plate or bridge with screwdriver when loosening bridge from plate.

**C. ASSEMBLY PROCEDURE OF SECONDS WHEEL AND MINUTE REGISTER WHEEL BRIDGE:**

Place bridge in its proper position on the plate, with the steady pins over the proper holes. Now place the seconds wheel and minute register wheel, so the pivots on these wheels enter the jewel holes in the bridge. Now, press bridge down to proper place with back of tweezers and replace fillister head screw FS-8.

After this bridge has been replaced, the minute register wheel should be checked to see that it pivots freely and has proper endshake.

The seconds wheel should also be checked for freedom, etc. Of course, the seconds wheel will not spin freely unless the tension on this wheel is released. (The seconds wheel tension spring holds the tension on this wheel.)

**D. FUNCTION OF SECONDS WHEEL AND MINUTE REGISTER WHEEL BRIDGE:**

The functions of the seconds wheel and minute register wheel bridge are as follows:

1. The function of this bridge is to provide a bearing surface for the top pivots of the seconds wheel and minute register wheel.
2. This bridge serves as a base for the various parts of the split seconds mechanism.

**REFERENCE:** Seconds wheel is Assembly 42.  
Minute register wheel is Assembly 44.

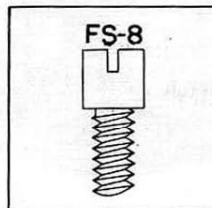

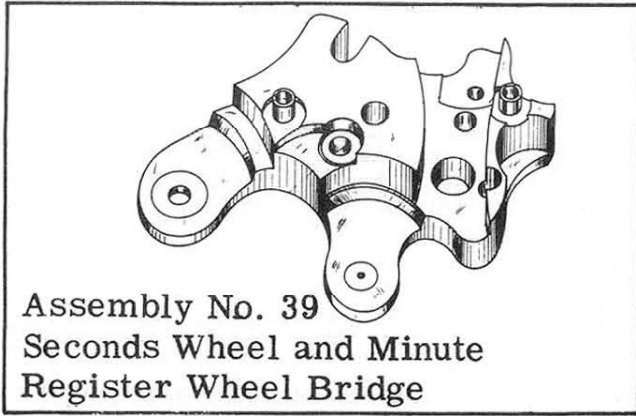

Assembly No. 39  
Seconds Wheel and Minute  
Register Wheel Bridge

**OILING**

The pivots in the jewels in seconds wheel and minute register wheel bridge should be oiled as you usually oil the train pivots in a watch.



TRAIN SIDE

39-A

**A. DISASSEMBLY PROCEDURE OF MINUTE REGISTER PAWL:**

This pawl is held in place by a fillister head screw FS-9 and a steady pin. Remove this screw and loosen pawl by sliding a thin blade screwdriver under pawl. When steady pin is free, pawl may be lifted out of place.

(The shape of screw for this part is shown at the bottom of page.)

**B. HAZARDS IN DISASSEMBLY OF MINUTE REGISTER PAWL:**

The blade on this pawl is extremely delicate and can be easily damaged by a slight slip of the screwdriver. Care must be taken in removing this pawl, so as not to harm it in any way.

**C. ASSEMBLY PROCEDURE OF MINUTE REGISTER PAWL:**

Place the pawl on the minute register pawl adjustment plate with steady pin on pawl in proper hole. Now replace fillister head screw FS-9 that holds this pawl in place. The pin "B" on the minute register pawl passing through the minute register pawl plate and into the slot in the barrel bridge serves as a guide to keep the adjustment plate from being shifted out of position.

Caution: The amount of tension that end "A" of pawl holds on minute register wheel should be very light, yet strong enough to keep the minute register wheel stationary until the wheel is turned by the chronograph mechanism. Too strong a tension on minute register wheel may cause the watch to stop. The end "A" of pawl must be highly polished and free from pits of rust. Any roughness at this location will cause the pawl not to function properly.

**D. HAZARDS IN ASSEMBLY OF MINUTE REGISTER PAWL:**

Be careful in replacing this pawl, as the blade on the pawl is very delicate and is easily damaged by a slip of the screwdriver, etc.

**E. FUNCTION OF MINUTE REGISTER PAWL:**

The minute register pawl serves two purposes:

1. This pawl correctly spaces the turning of the minute register wheel. This eliminates the possibility of the minute register wheel setting at an incorrect position.
2. It holds a tension on minute register wheel so that a bump or jar cannot alter the position of this wheel.

**REFERENCE:** Minute register wheel is Assembly 44.  
Minute register pawl adjustment plate is Assembly 41.

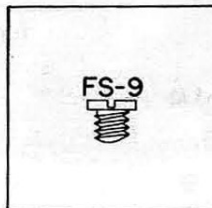

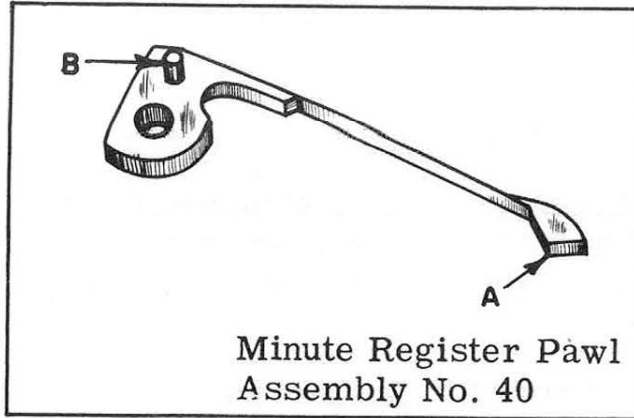

Minute Register Pawl  
Assembly No. 40

### OILING

The minute register pawl should not be oiled.



TRAIN SIDE

40-A

**A. DISASSEMBLY PROCEDURE OF MINUTE REGISTER PAWL ADJUSTMENT PLATE:**

To remove this plate, remove shouldered screw SS-11 that holds this plate in place. After screw has been removed, the adjustment plate will be free on the movement and can be lifted out of place.

(The shape of screw for this part is shown at bottom of page.)

**B. ASSEMBLY PROCEDURE OF MINUTE REGISTER PAWL ADJUSTMENT PLATE:**

Place the minute register pawl adjustment plate in its proper position on the movement, as shown on the photograph. Now replace shouldered screw SS-11 that holds this plate to the movement. The hole "A" in adjustment plate should fit directly over slot in plate.

**C. FUNCTION OF MINUTE REGISTER PAWL ADJUSTMENT PLATE:**

The function of this plate is to hold the minute register pawl above the level of the movement, and to make it possible to adjust the minute register pawl.

**REMARKS:**

This type of chronograph is called the semi-instantaneous type of chronograph. The minute register hand is stationary until the 58th second of registration. Between the 58th and 60th second of registration, the minute register hand moves forward very slowly. At the 60th second of registration, the minute register hand will move forward very quickly to complete the registration of one minute on the dial.

**REFERENCE:** Minute register pawl is Assembly 40.  
Minute register wheel is Assembly 44.

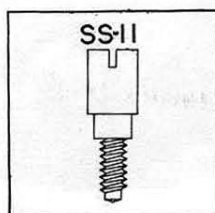

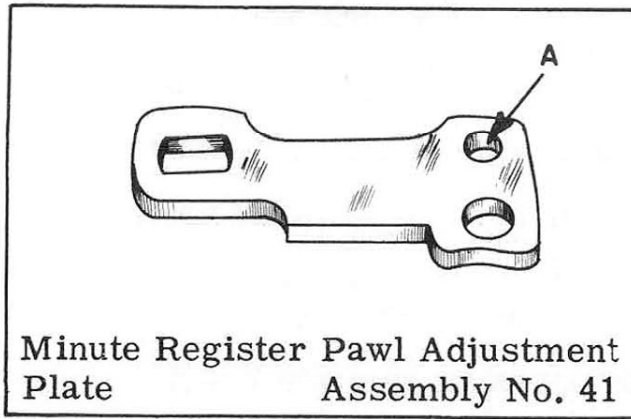

Minute Register Pawl Adjustment  
Plate Assembly No. 41

### OILING

The minute register pawl adjustment plate should not be oiled.



TRAIN SIDE

41-A

**A. DISASSEMBLY PROCEDURE OF SECONDS WHEEL:**

The seconds wheel is lifted out of place to remove it.

**B. HAZARDS IN DISASSEMBLY OF SECONDS WHEEL:**

Lift seconds wheel straight up when removing it. Any tilting of wheel may bend the pivot on the seconds wheel.

**C. ASSEMBLY PROCEDURE OF SECONDS WHEEL:**

Place wheel in its proper position with the long pivot "A" down in hollow center wheel pinion.

**D. FUNCTION OF SECONDS WHEEL:**

The functions of the seconds wheel are as follows:

1. The seconds wheel registers passage of seconds on the dial. This is done by a hand being attached to the long pivot "A" on seconds wheel.
2. The seconds wheel must move the minute register wheel forward one tooth, each time the seconds wheel makes one revolution. This is done by a dart tooth "C" attached to the seconds wheel. This dart tooth meshes with the teeth on intermittent wheel which, in turn, moves the minute register wheel one tooth.
3. The seconds wheel must return to a zero position when the flyback lever is brought in contact with heart on this wheel. Seconds wheel heart is shown as "B" on isometric drawing.
4. As the seconds wheel turns, it carries the split seconds heart which is attached firmly at the top of the seconds wheel hollow post.

**REMARKS:**

When the flyback lever is forced towards the center of the watch, and held at this position, check the seconds wheel and minute register wheel to see if either of these wheels will turn. The minute register wheel should turn slightly at this point, but the seconds wheel should be held very tight by the flyback lever. It is most essential for the seconds wheel to be held stationary by the flyback lever at a zero position. In the case of the minute register wheel, it does not have to be held absolutely stationary by the flyback lever, as the minute register pawl will serve this purpose. The only thing that the minute register wheel should be checked for is to see that the minute register wheel will not turn far enough to one side or to the other to let the minute register pawl drop into another tooth. This will assure that the minute register wheel will always be brought back to a zero position.

The advantage of having the minute register wheel turn slightly when the flyback lever is brought into the center of the watch is that if there is any wear in these parts, the seconds wheel and minute register wheel will still return to a zero position.

**REFERENCE:** Flyback lever is Assembly 31.

Intermittent wheel is shown on Page 45.

Split second heart is Assembly 16.



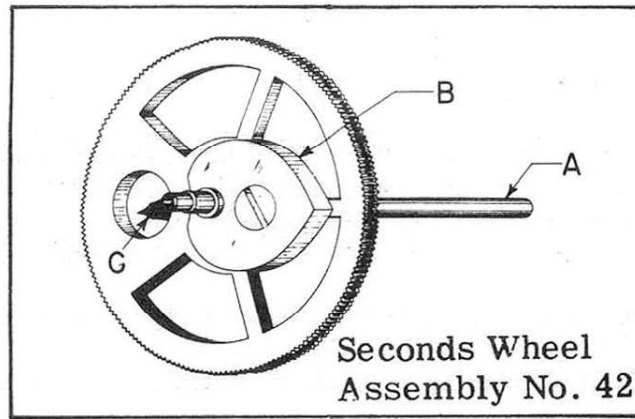

Seconds Wheel  
Assembly No. 42

### OILING

The top pivot on seconds wheel should be oiled after bridge for this wheel is placed in watch. The bottom pivot should not be oiled.

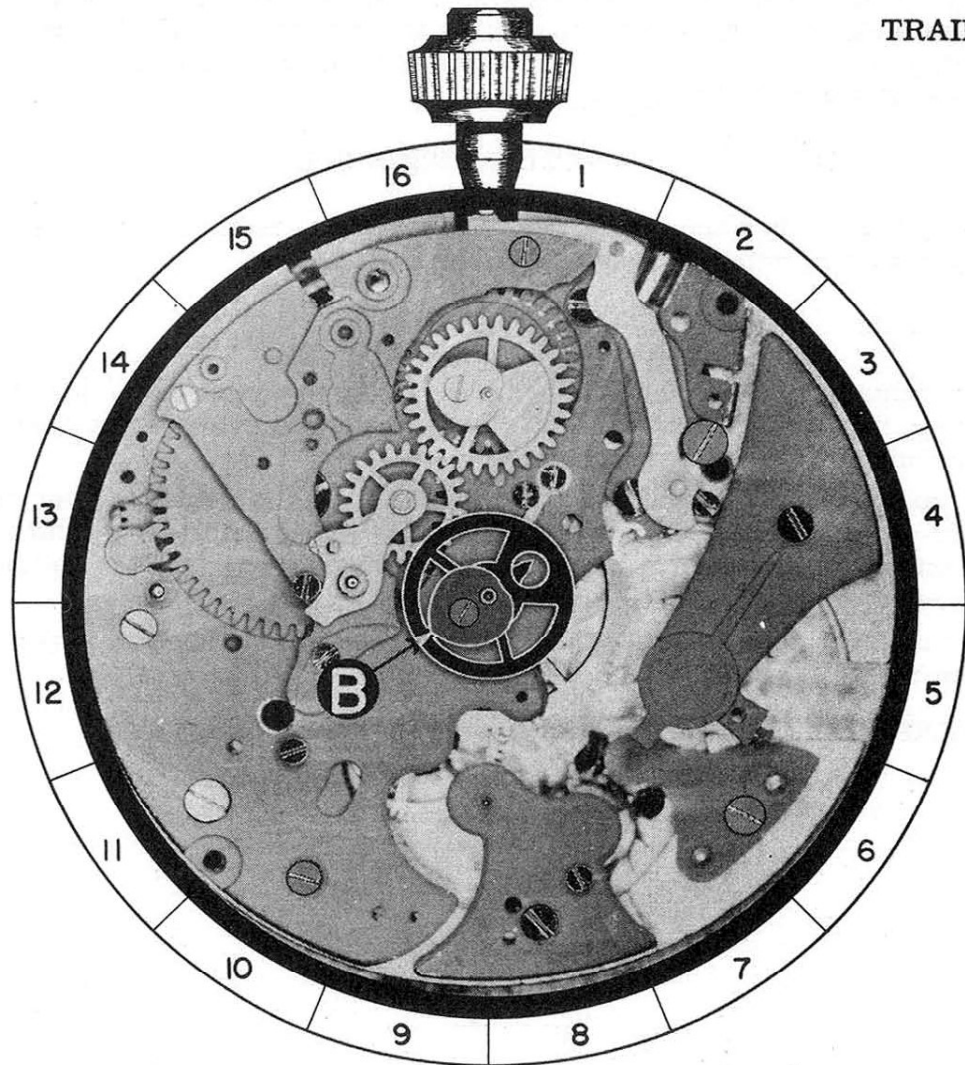

TRAIN SIDE

42-A

**A. DISASSEMBLY PROCEDURE OF SECONDS WHEEL TENSION SPRING:**

The seconds wheel tension spring is held in place by fillister head screw FS-10. After this screw has been removed, slide the seconds wheel tension spring from underneath the adjustment screw AS-2 to remove it. The position of this screw is shown on the photograph.

(The shape of screw for this part is shown at bottom of page.)

**B. ASSEMBLY PROCEDURE OF SECONDS WHEEL TENSION SPRING:**

Place the seconds wheel tension spring in its proper position on the plate. The raised part "B" on the spring should be slid under the head of adjustment screw AS-2. Now replace fillister head screw FS-10, but before tightening screw, center end "A" of spring over bushing for center wheel pivot. Screw may now be tightened to hold spring in proper position. After spring has been replaced and screw is tight, check end "A" of spring again and make sure it is still centered over bushing hole for center wheel. This spring should also be checked to make sure that it is right side up. The way to determine the side that should be up is to see that end "A" of spring is above the level of the plate and the polished side of spring is facing up.

**C. FUNCTION OF SECONDS WHEEL TENSION SPRING:**

This spring holds a tension on the seconds wheel so that it turns with an even action, with no irregular jumping or jerking.

**REMARKS:**

When replacing the spring, the end "A" of spring must be centered over the bushing for center wheel pivot. This is to prevent any contact of the spring with seconds wheel staff.

It is important to see that end "A" of this spring is centered over the center wheel pivot, for if it is not, the end "A" of spring will hold a tension on the side of second wheel staff, causing excess friction on this part, which may cause the watch to stop.

The seconds wheel tension spring should only hold an upward tension on the seconds wheel.

**REFERENCE:** Seconds wheel is Assembly 42.

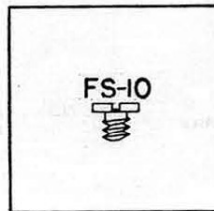

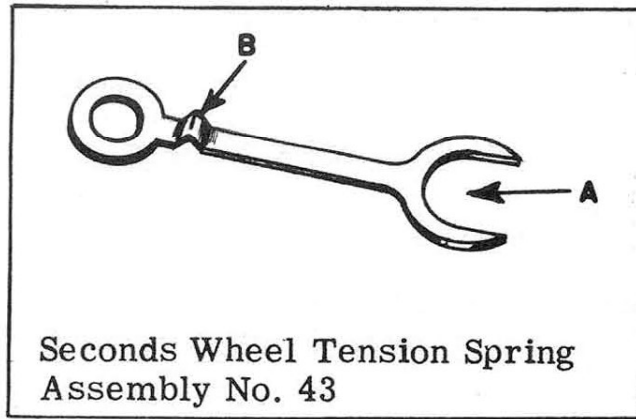

Seconds Wheel Tension Spring  
Assembly No. 43

### OILING

The seconds wheel tension spring should not be oiled.

TRAIN SIDE



43-A

**A. DISASSEMBLY PROCEDURE OF MINUTE REGISTER WHEEL:**

To remove this wheel, simply lift it out of place.

**B. HAZARDS IN DISASSEMBLY OF MINUTE REGISTER WHEEL:**

When removing this wheel, lift wheel straight up out of watch, as any twisting may bend or break the pivot on the minute register wheel.

**C. ASSEMBLY PROCEDURE OF MINUTE REGISTER WHEEL:**

Place the minute register wheel in its proper position in the watch, as shown on the photograph, with the long post "A" of this wheel down in pivot hole in plate.

**D. FUNCTION OF MINUTE REGISTER WHEEL:**

The function of the minute register wheel is to record the minutes that have elapsed since the beginning of the registration of the chronograph sweep second hand. The heart "B" of minute register wheel is used in returning this wheel to a zero position.

**REMARKS:**

The minute register wheel is returned to a zero position by the flyback lever contacting the heart on minute register wheel. The heart on this wheel is set eccentric. When the flat end of flyback lever contacts the eccentric heart, it forces the heart to turn. The heart will turn until the flat end of flyback lever sets across the two lobes at top of heart. With the pressure equalized at these two points, it will turn no further and this would be a zero position.

If this wheel has turned less than 160 degrees from a zero position when the flyback lever is brought in contact with the heart, it will turn in the opposite direction to which it was turning to bring this wheel back to a zero position. On the other hand, if the wheel is turned past 160 degrees from a zero position, the flyback lever will force the heart to continue to turn in the direction it was turning, until it reaches a zero position.

The degree used above is approximate, as this degree varies in most chronographs from 150 to 170 degrees.

**REFERENCE:** Flyback lever is Assembly 31.

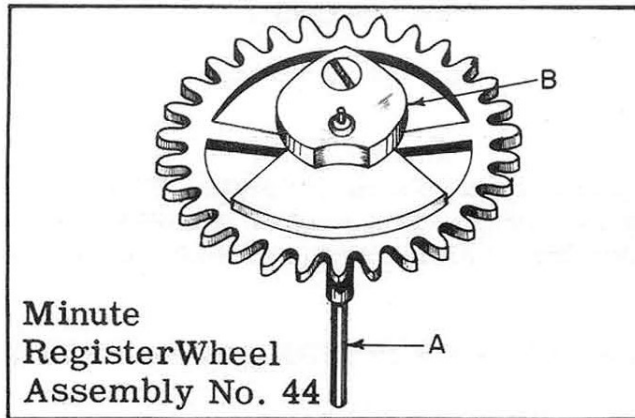

### OILING

The top and bottom pivots on minute register wheel should be oiled after bridge for this wheel is placed in watch. Oil these pivots as you usually oil the train pivots in a watch.

TRAIN SIDE



44-A

**A. DISASSEMBLY PROCEDURE OF INTERMITTENT LEVER AND WHEEL ASSEMBLY:**

This assembly pivots on a post in the plate. To remove it, grip bushing "B" on this assembly with a pair of tweezers and lift straight up. This will free the intermittent lever and wheel assembly from the post on plate.

**B. ASSEMBLY PROCEDURE OF INTERMITTENT LEVER AND WHEEL ASSEMBLY:**

Place hole in bushing in intermittent lever over proper post on plate, as shown in photograph. Now press assembly down on post to its proper place. Check this assembly to see that it pivots freely on this post.

**C. FUNCTION OF INTERMITTENT LEVER AND WHEEL ASSEMBLY:**

The function of intermittent lever is to engage and disengage the intermittent wheel with the seconds wheel dart tooth.

**REMARKS:**

When the flyback lever returns the wheels to a zero position, it forces the intermittent lever to move intermittent wheel away from center of watch, making it impossible for dart tooth to touch the intermittent wheel at this time.

The intermittent wheel should be carefully checked to see that it has proper endshake and spins freely in the intermittent lever. This wheel must, of necessity, spin freely, as any excess friction on the intermittent wheel may cause the following errors:

1. The intermittent wheel teeth meshing with the minute register wheel teeth, which are stationary, cause the intermittent wheel to pivot and turn on its axis, as it moves to engage with the dart tooth. When engaging with the dart tooth, if the intermittent wheel is binding, it turns the minute register wheel instead of turning on its axis, and may result in an error in the register of minutes.
2. The intermittent wheel binding may cause the minute register pawl to be unable to correctly space the turning of the minute register wheel, which may result in minute register hand setting at an incorrect position.
3. The intermittent wheel binding may cause the watch to stop, as the dart tooth on seconds wheel may not be able to turn this wheel.

**REFERENCE:** Seconds wheel dart tooth is Assembly 42-C.

Minute register wheel is Assembly 44.

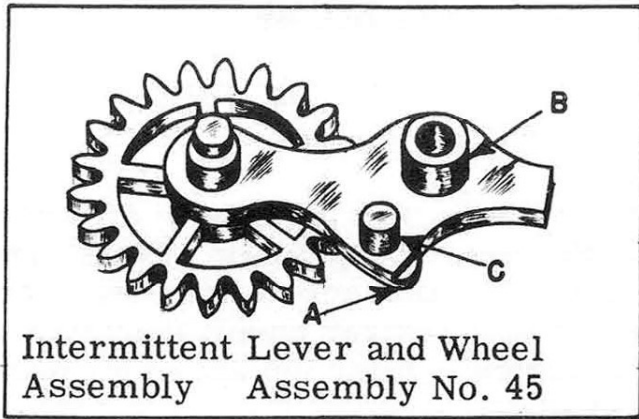

### OILING

The post that intermittent lever and wheel assembly pivots on should be slightly moistened with oil.



45-A

**A. DISASSEMBLY PROCEDURE OF CHRONOGRAPH ASSEMBLY PLATE:**

This assembly plate is held in place by fillister head screw FS-11 and steady pins. The position of this screw is shown on the photograph. After this screw has been removed, slide a finely sharpened screwdriver under assembly plate to loosen it from the movement. After the assembly plate is free, it can be lifted out of plate.

( The shape of screw for this part is shown at the bottom of page.)

**B. HAZARDS IN DISASSEMBLY OF CHRONOGRAPH ASSEMBLY PLATE:**

When loosening this plate from movement by sliding a finely sharpened screwdriver under this plate, care should be taken so as not to mar the assembly plate or the movement plate.

**C. ASSEMBLY PROCEDURE OF CHRONOGRAPH ASSEMBLY PLATE:**

Place the assembly plate in its proper position on the movement. The hole "A" in this plate fits over the detent setting screw. Now check to see that the steady pins are entering their proper holes in movement; then press the chronograph assembly plate down in place and replace fillister head screw FS-11. The position of this screw is shown on the photograph.

**D. FUNCTION OF CHRONOGRAPH ASSEMBLY PLATE:**

This plate provides a support for part of the chronograph mechanism.

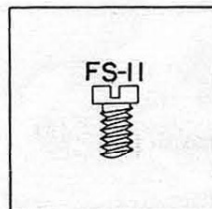



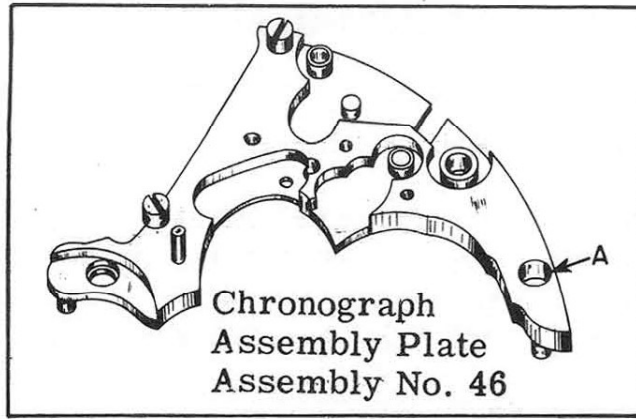

### OILING

The chronograph assembly plate should not be oiled.



46-A

A. DISASSEMBLY PROCEDURE OF SPLIT SECONDS ACTUATING DETENT LEVER:

The split seconds actuating detent lever pivots on post "B" in the plate and is held down in place by the next part to be assembled. To remove this detent lever, simply lift it straight up from post "B" and out of place.

B. ASSEMBLY PROCEDURE OF SPLIT SECONDS ACTUATING DETENT LEVER:

Place the split seconds actuating detent lever in position with hole in lever over post "B" on plate, as shown on photograph. The next part to be assembled holds this detent lever in place.

C. FUNCTION OF SPLIT SECONDS ACTUATING DETENT LEVER:

The function of split seconds actuating detent is to move the split seconds joint hook, which, in turn, moves the split seconds castle wheel one tooth, each time the lever is pushed.

D. REMARKS:

The distance the actuating detent lever can move when the end "C" of detent lever is pressed, is controlled by screw "D", as shown on the photograph.

REFERENCE: Split seconds joint hook is Assembly 19.  
Split seconds castle wheel is Assembly 20.

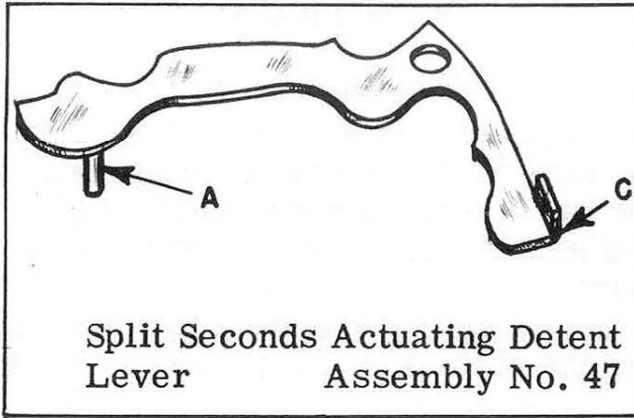

### OILING

The pin in plate on which the split seconds actuating detent lever pivots should be slightly moistened with oil.

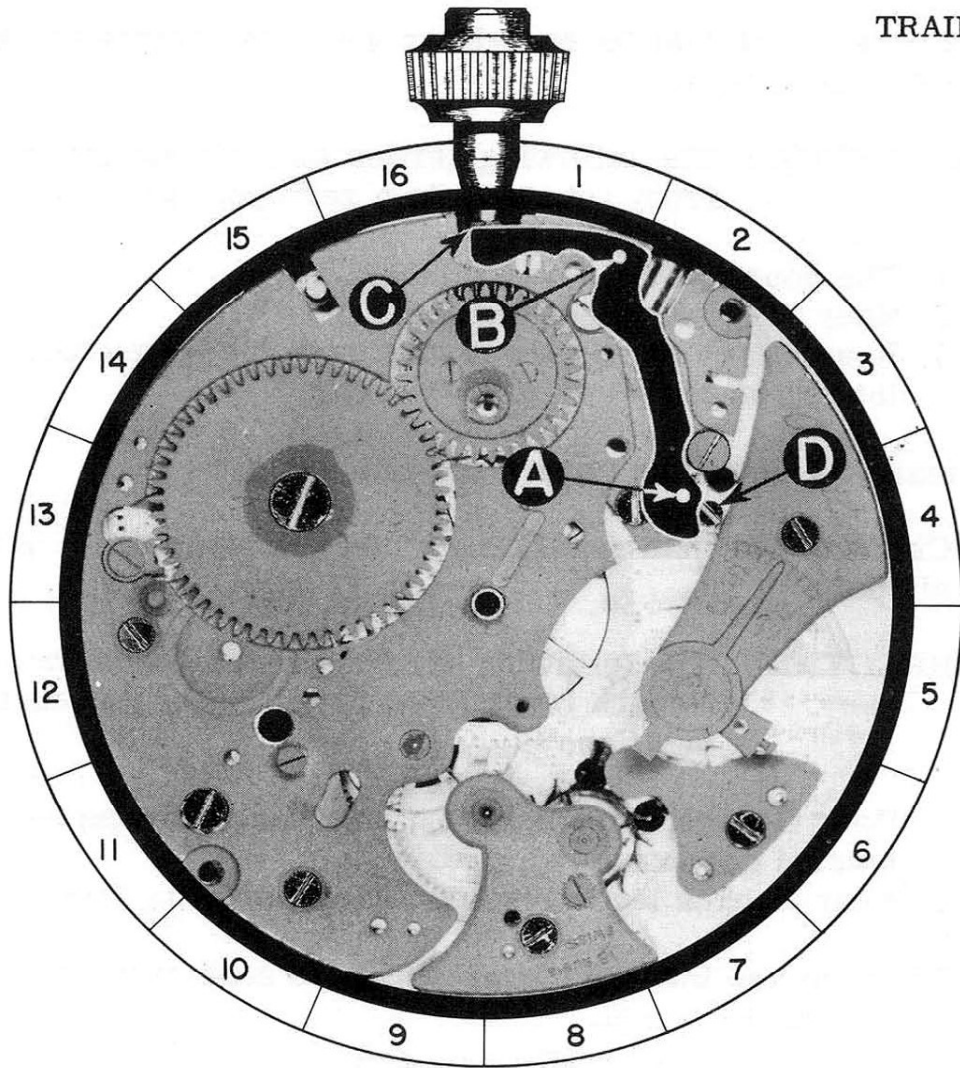

47-A

## FUNCTIONAL RESULTS

After completely assembling the chronograph with exception of the dial and hands, place the chronograph in front of you, pendant up, with the dial side of chronograph facing you. If the case for the chronograph has a snap on bezel and back, the chronograph should be placed in the case for checking the functional results. If the case is such that you cannot work on the dial side with the chronograph in the case, you will have to use a suitable tool to take the place of the buttons in the case in order to push the levers.

1. Push the button to the right of the pendant -- hold in this position and check the following:

(Make sure that the chronograph mechanism is not engaged, otherwise, button cannot be pushed.)

- A. Check to see that hour register wheel is returned to an exact zero position.

**CORRECTION:** The following errors can prevent this wheel from returning to a zero position:

1. The hour flyback lever binding
2. Hour register wheel binding.
3. Hour clutch spring not disengaging the hour clutch from the crown teeth on the barrel cap.

2. Release the button and check the following:

- A. Check to see that hour flyback lever returns to its original position.

**CORRECTION:** The following errors could prevent the hour flyback lever from returning to its original position:

1. Hour flyback lever spring not holding a strong enough tension on hour flyback lever.
2. Hour flyback lever binding and not pivoting freely.

- B. Check to see that hour brake lever is contacting teeth on hour register wheel.

(Continued on next page)

FUNCTIONAL RESULTS  
(Continued)

**CORRECTION:** The following errors could prevent the hour brake lever from contacting the teeth on the hour register wheel:

1. Hour brake lever binding, and not pivoting freely.
  2. Hour brake lever spring not holding proper tension on hour brake lever.
3. Push the button at left of pendant, and check the following:
- A. Check to see that the crown teeth on hour clutch are engaged with the crown teeth on barrel cap.

**CORRECTION:** The following errors could prevent the proper engagement of the hour clutch with the cap on barrel arbor:

1. Hour clutch spring not holding a strong enough downward tension on hour clutch.
2. Hour clutch binding on barrel arbor.
3. Hour driving lever spring not holding a strong enough tension on hour driving lever.
4. Hour driving lever or hour detent lever binding.

Now replace dial and hands on chronograph. If chronograph is not in its case at this time, it must be put in same, although back of case must be left off so that the following functions can be observed and checked:

(Proper method of replacing the chronograph hands is explained on page 55 in this book.)

Place chronograph in front of you, pendant up, with train side facing you.

4. Push the button at the left of the pendant -- release it and check the following:

(Make sure that the chronograph mechanism is not engaged, otherwise, button cannot be pushed.)

(Continued on next page)

FUNCTIONAL RESULTS  
(Continued)

- A. Check to see that seconds wheel and minute register wheel returns to a zero position, also check on the dial to see that the hands connected to these wheels return to a zero position.

**CORRECTION:** The following errors could prevent these wheels or hands from returning to a zero position:

1. Loose hands or hands not set correctly -- see page 55.
2. The minute register wheel, intermittent wheel, or seconds wheel binding and not pivoting freely.
3. Flyback lever spring not holding a strong enough tension on flyback lever.
4. Flyback lever binding, and not pivoting freely.

- B. Check to see that end "A" of minute register pawl lies directly in center between two teeth on minute register wheel when this wheel is at a zero position.

**CORRECTION:** The following errors could cause the minute register pawl not to lie centered between two teeth on the minute register wheel:

1. Minute register wheel binding.
2. Intermittent wheel binding.
3. Improper adjustment of minute register pawl.

(Proper adjustment of minute register pawl is explained in the text on adjusting of eccentric studs in the front of this book.)

- . Push the button at the right of the pendant -- release it and check the following:

- A. Check depthing of intermediary wheel teeth with seconds wheel teeth.

**CORRECTION:** The following errors could prevent the correct mesh of these teeth causing the intermediary wheel not to engage at all or the mesh to be shallow.

(Continued on next page)

**FUNCTIONAL RESULTS**  
(Continued)

1. Chronograph pivoted detent spring not holding enough tension on chronograph pivoted detent.
2. Chronograph pivoted detent binding.
3. Improper adjustment of eccentric stud can cause depthing of the intermediary wheel with the seconds wheel to be either too shallow or too deep. For information on adjusting eccentric studs read the text on adjusting eccentric studs in the front of this book.

B. Check depthing of seconds wheel dart tooth with intermittent wheel teeth.

**CORRECTION:** The following errors could prevent the proper depthing of dart tooth and intermittent wheel teeth:

1. Intermittent lever binding.
2. Intermittent lever spring not holding proper tension on intermittent lever.
3. Improperly adjusted eccentric studs.  
(See adjustment of eccentric studs text in the front of this book.)

For more detailed information for correcting the depth and clearance of the dart tooth with the intermittent wheel and a complete analysis of correcting unusual errors in the depthing, refer to the "Function Book" in the Esembl-O-Graf Library.

C. Check to see that the seconds hand moves forward in a steady manner with no irregular jumping or jerking.

**CORRECTION:** An irregular movement of the seconds hand is usually caused by the seconds wheel tension spring not holding enough tension on seconds wheel.

For information on increasing or decreasing the tension of the seconds wheel tension spring on the seconds wheel, refer to the remarks on page 21.

(Continued on next page)

FUNCTIONAL RESULTS  
(Continued)

6. Again push the button at the right of the pendant -- release it and check the following:

A. Check to see that brake lever is in contact with seconds wheel.

**CORRECTION:** The following errors could prevent the brake lever from contacting the seconds wheel:

1. Brake lever binding.
2. Brake lever spring not holding enough tension on brake lever.

7. Push the button at the right of the pendant again -- this should engage the chronograph to continue the registration. Now, if necessary, push the button in the center of the pendant so that the split seconds brake spring is engaged with the split seconds wheel. The split seconds wheel should not be turning.

A. Check to see that there is no great loss of power in the train of the watch causing a decrease in motion of the balance wheel.

**CORRECTION:** The following errors could cause a loss of power in the train of the watch causing a decrease in motion of the balance:

1. Spring "A" on Assembly #15 holding too strong a tension on lever "B" on Assembly #15.
2. Split seconds heart not highly polished.
3. Lever "B" on Assembly #15 binding.
4. Jewel "C" on split seconds wheel not turning freely.

8. Push the button in the center of the pendant -- release it and check the following:

A. Check to see that split seconds hand, which is the top hand, returns to its exact original position directly over the sweep seconds hand. At the same time, check to see that jewel "C" on the split seconds wheel is centered between the two lobes on the split seconds heart.

(Continued on next page)



**FUNCTIONAL RESULTS**  
(Continued)

**CORRECTION:** The following errors could prevent the above from taking place:

1. Split seconds wheel binding slightly.
2. Split seconds hand not perfectly free, touching crystal, etc.
3. Spring "A" on split seconds wheel not holding a strong enough tension on lever "B" on split seconds wheel.
4. Lever "B" on split seconds wheel binding.
5. Split seconds heart not highly polished.
6. Jewel "C" on split seconds wheel not turning freely.

## DIRECTIONS FOR READING CHRONOGRAPH DIAL

### A. THE TACHOMETER

The tachometer scale is used to indicate the speed of an object in miles per hour. The tachometer scale can only indicate the average speed of an object traveling over a course of a measured mile.

#### METHOD OF USING TACHOMETER

1. Start the chronograph sweep second hand at the exact moment the object to be timed starts to travel the measured distance of one mile.
2. When the object has traveled the course of one mile, stop the chronograph sweep second hand. The point on the tachometer scale where the sweep second hand stopped will indicate in miles per hour the average speed of the object over the measured mile.

### B. SECOND HAND

The second hand indicates the passing of seconds and should move one space each second. One complete revolution of the hand denotes the passage of one minute. This hand is independent of the chronograph mechanism and continues to register the seconds as long as the watch is running.

### C. SPLIT SECOND SCALE

This scale is divided into 300 divisions, each indicating  $1/5$  of a second. Every fifth division is marked with extra long lines denoting one second.

### D. MINUTE REGISTER

The minute register hand indicates on the dial the number of minutes that have elapsed since the beginning of the registration of the sweep second hand. One complete revolution of the minute register hand indicates the passage of 30 minutes; two revolutions, one hour.

### E. HOUR REGISTER

The hour register hand indicates on the dial the half hour and hour periods that have elapsed since the beginning of the registration of the sweep second hand. Each division on the scale denotes  $1/2$  hour. Each number on the scale denotes one hour. One complete revolution of hour register hand indicates 12 hours have elapsed. This hand will register the hours as long as the chronograph mechanism is in operation.

### F. SPLIT SECOND HAND

The purpose of the split second hand is to enable the operator to complete one or more registrations for recording purposes without interfering with or interrupting a continuation of the registration.

**EXAMPLE:** For Timing Races

As the first runner passes the winning line, stop the split second hand (which is the top hand). Then at the instant the second runner passes the winning line, stop the sweep second hand. In this way, the timing of the two runners can be made even if the runners are very close in running. In other words, the split second chronograph can be used as two chronographs.

If the runners are not very close in running, as in long distance races, more than two registrations can be made. This can be done by stopping the split second hand at the instant the first runner passes over the winning line and making a record of the time. Then push the button to catch up the split second hand with the sweep second hand, and as the second runner passes over the winning line, stop the split second hand, and again record the time. This can be continued indefinitely until the last runner passes over the winning line.

# THE CHRONOGRAPH DIAL

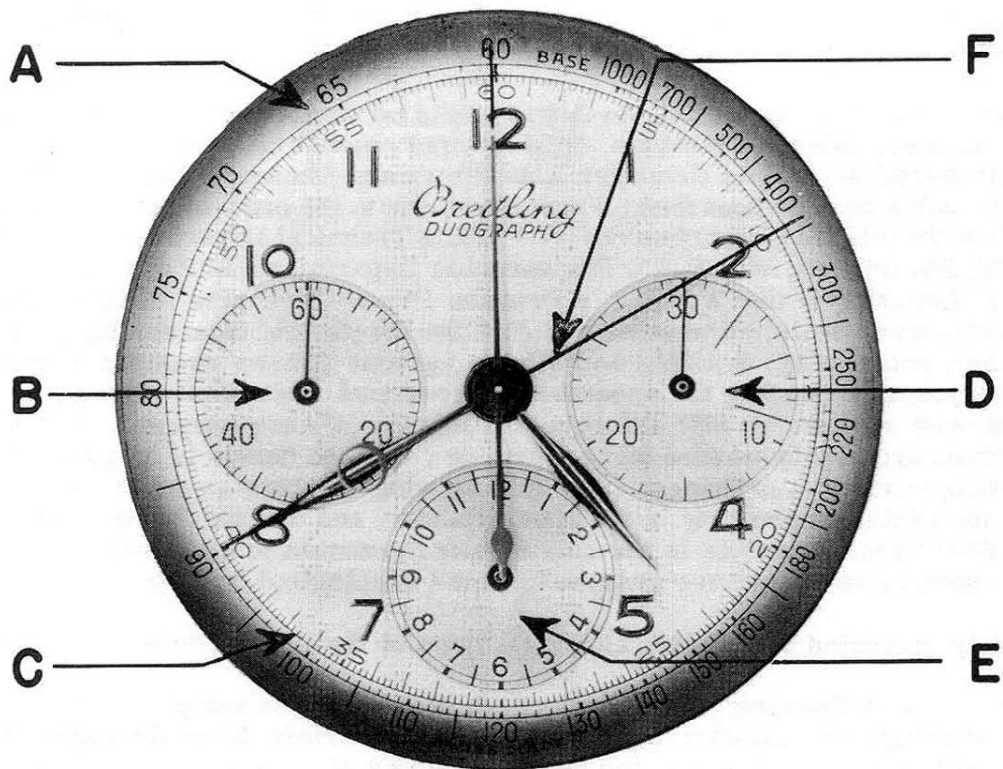

## SETTING THE HANDS CORRECTLY ON A CHRONOGRAPH

When replacing the hands on a chronograph, it is a definite advantage to have the movement in the case and the buttons in their respective positions. With the movement in its case it is an easy matter to push the button returning the seconds wheel, minute register wheel and hour register wheel to a zero position, so that the chronograph hands can be replaced in their correct position. However, if the case is the waterproof type which prevents the replacing of the hands while the movement is in the case, then the hands must be replaced before replacing the movement in the case and a suitable tool used to take the place of the buttons in order that the wheels can be returned to a zero position, making it possible to replace the chronograph hands in their correct position.

After the chronograph is assembled in working condition and the dial replaced, then replace the second hand, hour hand, and minute hand as you would on a watch. Now, with a suitable tool or button, force the flyback lever and hour flyback lever to return their respective wheels to zero. While the flyback levers are holding the wheels at zero, replace the minute register hand at 30 on the minute register scale "D", the hour register hand at 12 on the hour register scale "E", and the sweep seconds hand at 60 on the split seconds scale "C". The flyback lever may now be released. Now if necessary, push the button in the center of the crown to disengage the split seconds brake spring from the split seconds wheel. Then replace the split seconds hand directly over the sweep seconds hand, supporting the jewel at the bottom of sweep seconds post while pressing down to position. The chronograph should be engaged and let run for a period of time, then the hands returned to zero. This should be repeated several times as a check to make sure that all the chronograph hands return to their respective zero positions.