

FULLY ILLUSTRATED  
**CHRONOGRAPH REPAIRING**  
FUNCTIONAL ADJUSTMENTS OF THE CHRONOGRAPH MECHANISM  
VOLUME 24

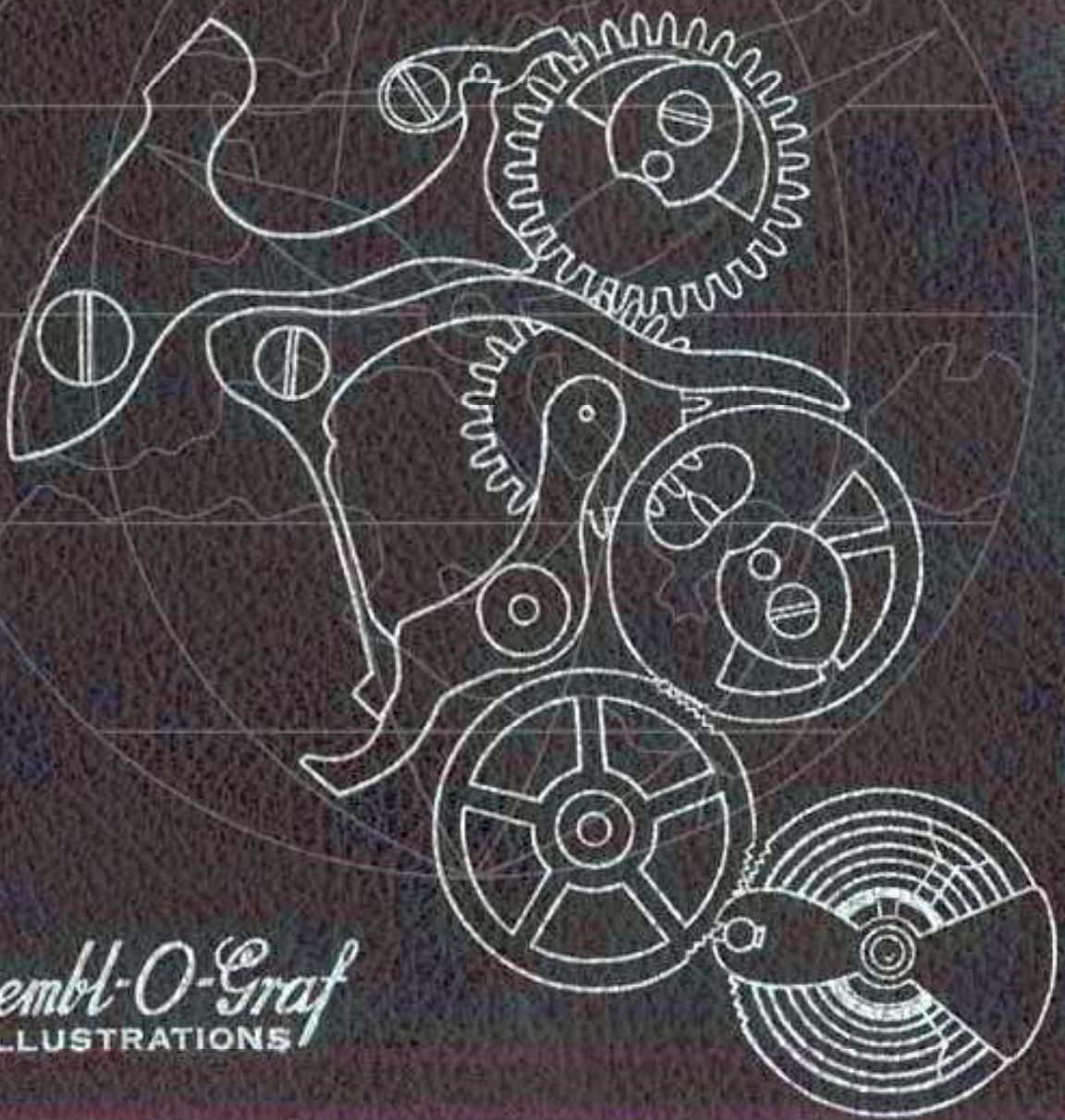

*Essembl-O-Graf*  
ILLUSTRATIONS

This page intentionally left blank



# ESEMBL-O-GRAF

## FULLY ILLUSTRATED **CHRONOGRAPH REPAIRING** FUNCTIONAL ADJUSTMENTS OF THE CHRONOGRAPH MECHANISM



BY

**William O. Smith, Sr.**

PRESIDENT AND TECHNICAL DIRECTOR

AND

**William O. Smith, Jr.**

CHIEF ENGINEER, RESEARCH LABORATORIES

WESTERN PENNSYLVANIA HOROLOGICAL INSTITUTE, INC.  
PITTSBURGH, PENNSYLVANIA





## P R E F A C E

In recent years, there has been an increase in the number of chronographs sold throughout the world. This rise in popularity of the chronograph is a direct result of technological progress and the actual need for split second recording timepieces. These timepieces, formerly being handmade, were out of the reach of the watch buying public, but within recent years, this has changed. Modern manufacturing processes have made the chronograph a commercial possibility by providing better methods, tools, and material for its construction.

Never before has the chronograph watch become so important. In this Atomic Age, the use of the chronograph is so wide and varied that it is impossible to note all its uses. Variety in the types of chronographs, such as the split second chronograph, the catch up chronograph, chronograph with tachometer and telemeter, chronograph with pulsometer, slide rule, etc., makes the chronograph an instrument that is flexible in its use. Because of the paramount need, and the growing popularity of the chronograph, it is becoming a necessity to train competent chronograph technicians to repair these chronographs. It is needless to say that the average watchmaker does not have the information to repair chronographs. This makes the situation appalling, as there is very little skilled help in this country that can repair chronographs and do a good job on them. However, this picture is changing, and many watchmakers who never repaired chronographs before are learning to repair them. Credit is due in a large measure to the twenty-four volume Esembl-O-Graf Library which made this possible, and to the diligent and consistent efforts of the Esembl-O-Graf Research Laboratories.

This, and the other volumes of the Esembl-O-Graf Library are a source of information that can benefit the store owner and the manager, as well as the watchmaker. It means that he has at his fingertips a complete source of information for the repair of any type chronograph. The Esembl-O-Graf Library will be the means of eliminating the necessity of turning away customers simply because they have a complicated watch to repair. Years ago, there were so few chronographs on the market that if the jeweler turned down complicated watch repairing, he didn't stand to lose very much. Today, the condition has changed considerably. Today, nearly every jewelry store is selling complicated watches, and must have a watchmaker who is qualified to repair these watches. If the jeweler does not have a watchmaker who can service complicated watches, he is going to eventually lose business.

After working 14 years, practically day and night, to develop the training methods necessary for training watchmakers, the authors have but one thought in mind in producing these volumes: to present the facts in such a way that the average watchmaker can follow the instructions and repair a chronograph with confidence that he will do a complete and skilled job. You will be pleased to know that intense concentration will not be necessary. You will find this volume as clear and easily understood as the other volumes.

The volumes of the Esembl-O-Graf Library, with the exception of this volume, deal primarily with the basic knowledge of chronograph repairing, such as the method and procedure of disassembling and assembling each type of chronograph, the function and oiling of each part, and minor adjustments that are made by turning the eccentric studs. This volume twenty-four goes much deeper into the subject of chronograph repairing, and deals primarily with; 1. How the function of a chronograph is performed. 2. The various checks that should be made to insure the proper functioning of the chronograph. 3. The method of correcting unfavorable conditions that hinder or prevent the proper functioning of the chronograph.

The Watchmakers Esembl-O-Graf Library represents the worlds most complete works ever published on chronograph mechanisms. Using revolutionary ideas and methods of illustrating, the authors divided each phase of the various mechanisms, and for each and every line of instructions, there is a drawing on the opposite page illustrating every minute detail.

Since the Esembl-O-Graf Research Laboratories was the first to pioneer in formulating new methods of step-by-step instructions for the disassembly and assembly procedure for all popular chronographs, it was our plan in the beginning to carefully accumulate all unusual repair and adjusting problems during the time the Library was being written. Therefore, volume twenty-four required almost 3 years to produce.

It is obvious therefore, that every single illustration and every word of instruction is entirely new since there was no complete information on the subject available to the watchmaker until the worlds first and only fully illustrated chronograph course was published by the Esembl-O-Graf Research Laboratory.

The authors feel that this volume on chronograph repairing will be a most valuable addition to the Esembl-O-Graf Library, and that it will help the repairman to more fully understand the repair and servicing of chronograph watches.

William O. Smith, Sr.

Pittsburgh, Pa. 1949

William O. Smith, Jr.



## TABLE OF CONTENTS

### PART 1

	Page
FUNCTION AND ADJUSTMENT OF THE FLYBACK LEVER ON THE HEARTS. . . . .	1
Returning to zero of the seconds heart. . . . .	1
Returning to zero of the minute register heart. . . . .	3
Repair of the flyback lever. . . . .	5
Checking the returning to zero action of the flyback lever on the heart. . . . .	11
Removing a flat spot on a heart. . . . .	11
Adjusting the flyback lever for proper height. . . . .	13

---

### PART 2

FUNCTION AND REPAIR OF THE FLYBACK LEVER IN A 2 BUTTON CHRONOGRAPH. . . . .	15
Function of the flyback lever as it is moved towards the hearts on the seconds wheel and minute register wheel. . . . .	15
Disengaging of the brake lever. . . . .	17
Checking for the proper disengagement of the brake lever. . . . .	19
The reason the intermittent wheel must disengage from the dart tooth in the returning to zero function. . . . .	19
Arrangement in the chronograph to insure the instant returning of the hearts to a zero position. . . . .	21
Repair of the retarding type flyback lever. . . . .	21

---

### PART 3

TRIP TYPE FLYBACK LEVER. . . . .	23
Operation of the trip type flyback lever. . . . .	23
Returning of the flyback lever to its original starting position. . . . .	23
Function of the trip type flyback lever. . . . .	25
Conditions that can prevent the proper functioning of the trip type flyback lever. . . . .	25

The proper method of checking the function of the trip type flyback lever. . . . .	27
Repairing the trip type flyback lever. . . . .	27

---

PART 4

NON-CASTLE WHEEL CHRONOGRAPH. . . . .	31
Function of the flyback lever in a non-castle wheel type chronograph. . . . .	31
Function of the flyback lever as it is moved towards the hearts. . . . .	31
Mechanism that controls the movement of the flyback lever. . . . .	33

---

PART 5

ONE BUTTON CHRONOGRAPH. . . . .	36
Function of the one button chronograph, paying particular attention to the flyback lever. . . . .	37
Effect of magnetism in a chronograph. . . . .	40

---

PART 6

MINUTE REGISTER MECHANISM (Its function and adjustment). . . . .	41
The properly adjusted minute register mechanism. . . . .	41
Setting the proper depth of the intermittent wheel with the dart tooth by means of adjusting eccentric studs. . . . .	45
Corrections in the setting and depth of the intermittent wheel with the dart tooth that cannot be made by merely adjusting eccentric studs. . . . .	47
Method of correcting the setting of the intermittent wheel in relation to the dart tooth without the changing of the minute register pawl. . . . .	49
Removing the dart tooth from the seconds wheel. . . . .	51
Shortening the dart tooth. . . . .	51
Replacing the dart tooth on the seconds wheel. . . . .	53
Setting the dart tooth to its proper position on the seconds wheel. . . . .	53
Turning the dart tooth on the post of the seconds wheel. . . . .	57



Tightening the dart tooth on the post of the seconds wheel. . . . .	57
Length of the dart tooth and its effect on the chronograph. . . . .	59
The angle of the inclined plane of the minute register pawl and its effect on the chronograph. . . . .	61
Adjustable minute register pawl. . . . .	66
Some other types of adjustable minute register pawls. . . . .	67
Setting the proper tension of the minute register pawl on the minute register wheel. . . . .	69
Releasing or adding tension to the minute register pawl. . . . .	71

---

### PART 7

THE PIERCE CHRONOGRAPH. . . . .	73
The minute register mechanism and its adjustment in the Pierce chronograph. . . . .	73
How to use the heart adjusting tool. . . . .	75
Returning to zero of the hearts in a Pierce chronograph. . . . .	77
Engaging and disengaging of the Pierce chronograph. . . . .	77
Setting the dart tooth to its proper position when the hearts are at a zero position. . . . .	77
Turning the dart tooth on the chronograph staff in a Pierce chronograph. . . . .	81

---

### PART 8

SECONDS WHEEL TENSION SPRING AND ITS ADJUSTMENT. . . . .	82
Setting the correct tension of the seconds wheel tension spring and eliminating any irregular jumping or jerking of the sweep second hand. . . . .	82
Setting the tension of the seconds wheel tension spring in a chronograph that has no brake lever. . . . .	84
Checking the drag on the train of the watch caused by the seconds wheel tension spring and the minute register pawl. . . . .	84

---

### PART 9

OSCILLATING PINION CHRONOGRAPH. . . . .	85
Engaging and disengaging of the oscillating pinion. . . . .	85
Error in the registration created when the chronograph is engaged. . . . .	85

PART 10

CHRONOGRAPH WHEELS AND GEARING. . . . . 91  
Removing the wheel-over-fourth-wheel. . . . . 91  
Straightening the long pivot on the fourth wheel. . . . . 91  
Truing the wheel-over-fourth-wheel in the flat. . . . . 93  
Truing the wheel-over-fourth-wheel in the round. . . . . 93  
Setting the proper depth of the chronograph wheels. . . . . 95

---

PART 11

SHOULDERED SCREWS. . . . . 97  
Shortening or lengthening the shoulder of a screw. . . . . 97  
Making a shouldered screw from a regular screw. . . . . 97

---

PART 12

ECCENTRIC STUDS. . . . . 99  
Tightening eccentric studs. . . . . 99  
Loosening eccentric studs. . . . . 101  
Making eccentric studs. . . . . 101

---

PART 13

ADJUSTING AND FORMING OF CHRONOGRAPH SPRINGS. . . . . 105  
Adjusting chronograph springs. . . . . 105  
Forming a wire spring. . . . . 107

---

PART 14

CHRONOGRAPH HANDS. . . . . 109  
Setting the proper clearance of the hands on a chronograph. . . . . 109  
Tightening of chronograph hands. . . . . 109

---

PART 15

NOMENCLATURE OF PARTS. . . . . 110



## SEPARATING THE CHRONOGRAPH INTO THREE DIVISIONS FOR STUDY PURPOSES



- Returning to Zero Mechanism. . . . . Pages 1 to 40, 77, 78
- Minute Register Mechanism. . . . . Pages 41 to 81
- Engaging Mechanism. . . . . Pages 31, 32, 37 to 40, 77, 78, 82 to 96

In this volume, we have divided the chronograph into three distinct parts, or sections: 1. The minute register mechanism, 2. The engaging mechanism, 3. The returning to zero mechanism. See Illustration above. The reason for separating the chronograph into sections is so that the repairman could concentrate on one section of the chronograph at a time, making it easier to understand, and eliminating any confusion.

This method of presentation of chronograph repairing, we believe will also help the repairman separate in his own mind the different sections of a chronograph, and the various arrangements of these different sections. For instance, in this book, when dealing with the returning to zero mechanism, shown in green above, we cover from pages 1 to 40, the different types of returning to zero mechanism without splitting up this information with other subjects that only have a remote relationship. Even in the repair of a chronograph at the bench, all sections of the chronograph should not be considered at one time. Each section of the chronograph must be treated separately, and only these sections considered together as a unit at the places they interlink. Keeping this in mind when studying this book, the repairman can accumulate in an orderly manner the knowledge of chronograph repairing. Also, it should be kept in mind that a haphazard accumulation of thoughts in regards to chronograph repairing without separating them only leads to confusion, and more than likely to a haphazard repair job.

## CHECKING A CHRONOGRAPH FOR PROPER FUNCTIONING

There are certain checks that should be made in the chronograph after it is assembled, to insure the proper functioning of the chronograph mechanism. If a definite method or procedure for making these checks is not followed, some of the checks may be missed, which may result in errors passing undetected. In order to eliminate as much as possible the overlooking of an error in the chronograph mechanism, we have listed the various checks that should be made in chronographs, along with the page number that can be referred to for complete information in regards to each check.

We have used this list of checks satisfactorily for many years, and feel this list will prove very valuable to the repairman in pointing out errors that might have gone undetected. In using this list of checks, you will find that in certain chronographs, because of their construction, all the checks listed below cannot be made. For instance, in the type of chronograph in which there is no brake lever, Check No. 4, listed below, must be omitted.

There are many additional checks that could be added to the list below, such as checking the screws to see that they are tight, checking the wheels and various parts to see that they are free, etc. However, these are things that should definitely be checked as each part is assembled, and thus we have not included them in our list.

### CHECKS THAT SHOULD BE MADE TO INSURE THE PROPER FUNCTIONING OF THE CHRONOGRAPH

	Pages
1. Check the seconds wheel to see that it returns to an exact zero position. . . . .	1 to 10
2. Check the minute register wheel to see that it returns to an exact zero position. . . . .	1 to 10
3. Check the flyback lever for height. . . . .	13, 14
4. Check the brake lever to see that it disengages properly from the seconds wheel when the returning to zero function is taking place. . . . .	19, 20, 25, 26, 39, 40
5. Check the intermittent wheel to see that it disengages from the path of the dart tooth when the returning to zero function is taking place. . . . .	15 to 20, 25, 26, 31, 32, 39, 40
6. Check for proper clearance of the intermittent wheel as it engages with the dart tooth. . . . .	55, 56
7. Check for proper depth of the intermittent wheel with the dart tooth and the proper entering and leaving clearance of the dart tooth. . . . .	41 to 52
8. Check the mesh or depth of the wheel-over-fourth-wheel, intermediary wheel, and seconds wheel. . . . .	95, 96
9. Check the trueness of chronograph wheels. . . . .	91 to 96
10. Check the tension of the seconds wheel tension spring. . . . .	82 to 84
11. Check the tension of the minute register pawl. . . . .	69 to 72
12. Check to see that the chronograph engaged will run for a period of at least 24 hours. . . . .	84
13. Check tightness of eccentric studs. . . . .	99, 100
14. Check setting, tightness, and spacing of chronograph hands. . . . .	109
15. Check for the proper returning to zero of the hands, and for flat spots or burrs on the hearts. . . . .	11, 12
16. Check for magnetism. . . . .	40
17. Check to see that the minute registration occurs exactly on the 60th second of registration. . . . .	53 to 58



## EXPLANATION OF A CHRONOGRAPH

A chronograph is a precision instrument that measures and registers time. To be more specific, it is an ordinary watch which registers the time of day, plus an added feature of a sweep second hand that can be stopped, started, and returned to zero at will by the operator.

A chronograph that only carries a sweep second hand is known as a simplified chronograph. There are not many of these chronographs on the market, as generally, a minute register is added to the chronograph which makes it possible for the chronograph to not only measure the seconds of a registration, but also the minutes. In addition to the seconds and minute register, there is many times an hour register added to the chronograph. This makes it possible for the chronograph not only to measure the seconds and minutes of a registration, but also the hours. All the chronograph hands on a chronograph work in unison. When the seconds hand is returned to zero, the minute register hand and hour register hand are also returned to zero, and will remain at zero until the registration of the chronograph is started. Then of course, the sweep second hand will register the seconds, the minute register hand will register the minutes, and the hour register hand will register the hours.

Since the returning to zero function of the chronograph is the most remarkable function, and one of the most important of the three functions of the chronograph, 1. Starting, 2. Stopping, 3. Returning to zero, we will start this book with the study of the returning to zero of the chronograph.



## PART 1

### FUNCTION AND ADJUSTMENT OF THE FLYBACK LEVER ON THE HEARTS

#### RETURNING TO ZERO OF THE SECONDS HEART

Before starting a new registration, the sweep second hand must be brought to an exact zero position. The parts that make it possible to return the sweep second hand to a zero position are the flyback lever "A", heart "B", and staff "C", as shown in Illustration 1-A. The heart and sweep second hand "D" are firmly attached to the staff. This makes it possible that when the heart is returned to a zero position, the hand is also returned to a zero position.

Illustrations 1-B and 1-C shows the flyback lever moving toward the staff, forcing the heart to turn to a zero position. Illustration 1-B shows the flyback lever forcing the heart to turn in a clockwise direction, while Illustration 1-C shows the flyback lever forcing the heart to turn in a counter-clockwise direction. Thus, the flyback lever may turn the heart clockwise or counter-clockwise, depending upon the amount the heart has turned from a zero position when the flyback lever is brought in contact with the heart. Also in Illustrations 1-B and 1-C, you will notice that the flyback lever, as it moves toward the staff, will force the heart to turn until the flyback lever reaches a point on the heart that is closest to the staff. At this position, the flyback lever will set across the two lobes "E" and "F" at the top of the heart. With the pressure of the flyback lever equalized on these two lobes, the heart will turn no further, and this is what is commonly known as a zero position.

It is very important that the outside surface of the heart and the part of the flyback lever that contacts the heart, be highly polished. This will assure a smooth easy turning of the heart by the flyback lever.

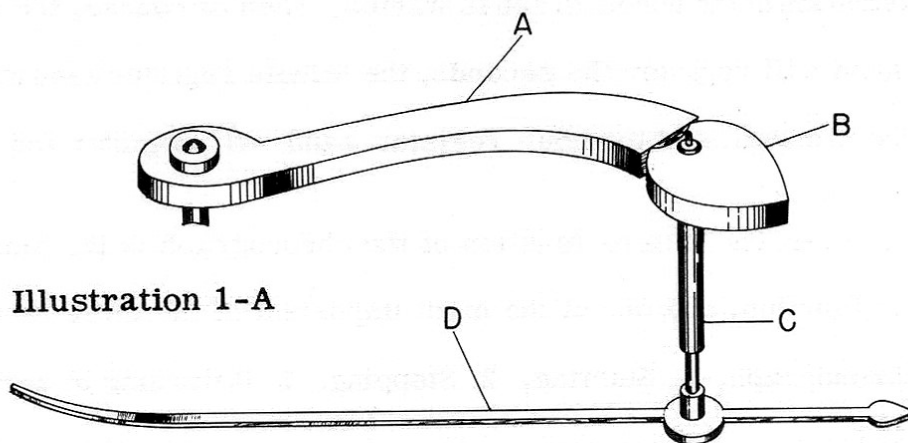

Illustration 1-A

- A - Flyback Lever
- B - Heart
- C - Staff
- D - Sweep Seconds Hand

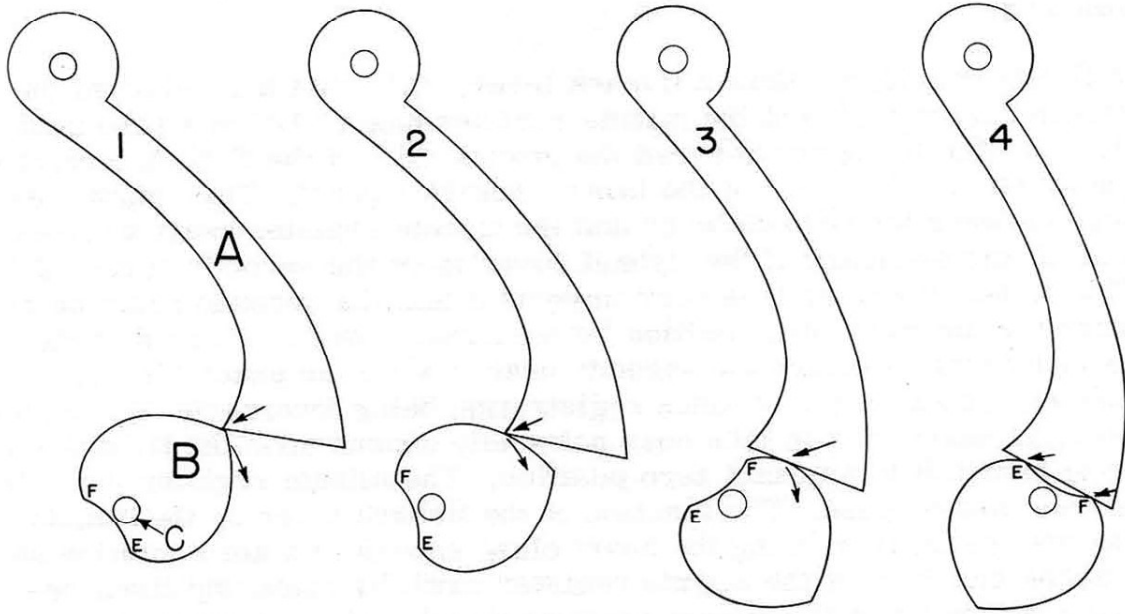

Illustration 1-B

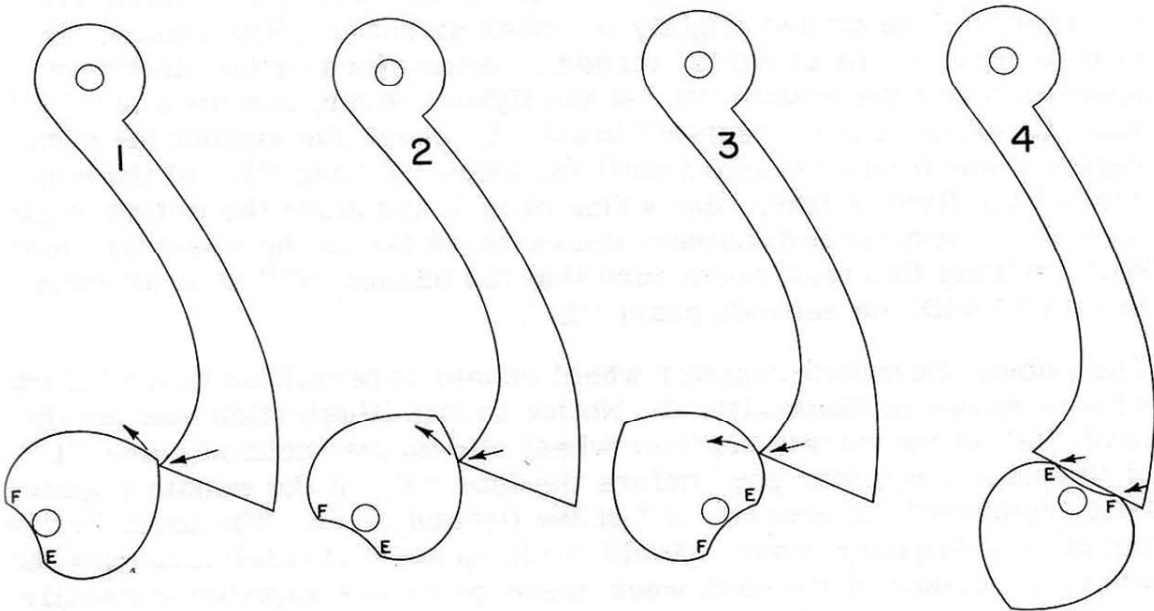

Illustration 1-C

## RETURNING TO ZERO OF THE MINUTE REGISTER HEART

In addition to returning the sweep second hand to zero, the flyback lever in most chronographs must return a minute register hand to zero. The returning to zero of the minute register hand is accomplished in much the same way as the returning to zero of a sweep second hand, except for one slight difference. This difference is illustrated in the following.

In Illustration 2, we show a flyback lever, "A", that has returned the seconds heart "E" and the minute register heart "D" to a zero position. Notice the space between the branch "B" of the flyback lever and the lobes "J" and "K" of the minute register heart. This small clearance between the flyback lever and the minute register heart assures that all the pressure of the flyback lever is on the seconds heart "E". This is necessary as it is very important that the seconds heart be returned to an exact zero position by the flyback lever. Failure of the flyback lever to return the seconds heart "E" to an exact zero position will result in the seconds registration being incorrect. The minute register heart "D" in turn does not solely depend upon the flyback lever to return it to an exact zero position. The minute register pawl "H" serves this purpose. The function of the flyback lever on the minute register heart is to bring the heart close enough to a zero position so that the end "O" of the minute register pawl, by centering itself between two teeth of the minute register wheel "F", can return the minute register heart to an exact zero position.

Due to the clearance between the lobes "J" and "K" of the minute register heart and the branch "B" of the flyback lever, the minute register wheel can be turned slightly in either direction. The amount the minute register wheel can be turned is determined by the amount of space between the branch "B" of the flyback lever, and the lobes "J" and "K" of the minute register heart. To check the amount the minute register wheel can be turned until the lobes "J" and "K" of the heart contact the flyback lever, use a fine broach and move the minute register wheel clockwise and counter-clockwise as far as the wheel will turn. When making this test, make sure that the branch "C" is at all times in contact with the seconds heart "E".

The amount the minute register wheel should be permitted to turn clockwise is shown in Illustration 3. Notice in this Illustration how far the tooth "e" of the minute register wheel slid up the inclined plane "L" of the minute register pawl before the lobe "K" of the minute register heart contacted the branch "B" of the flyback lever. The tooth "e" of the minute register wheel should slide up approximately one-half the working surface of the pawl when these parts are adjusted correctly.

The heavy line on the inclined plane "L" of the minute register pawl, Illustrations 3 and 4, indicates the portion of the pawl that is referred to as the working surface of the pawl.

- A - Flyback lever
- B - Flyback lever branch
- C - Flyback lever branch
- D - Minute register heart
- E - Seconds heart
- F - Minute register wheel
- G - Seconds wheel
- H - Minute register pawl
- J - Lobe of heart
- K - Lobe of heart
- L - Inclined plane of minute register pawl

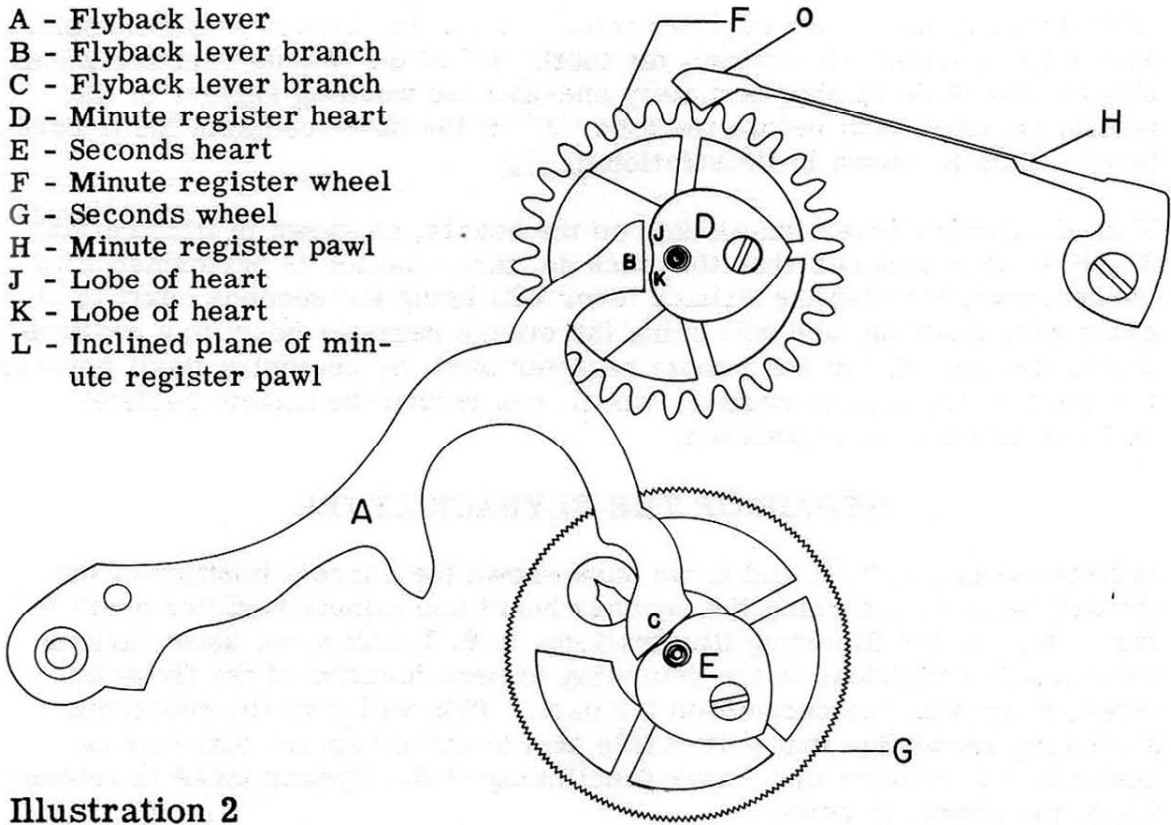

Illustration 2

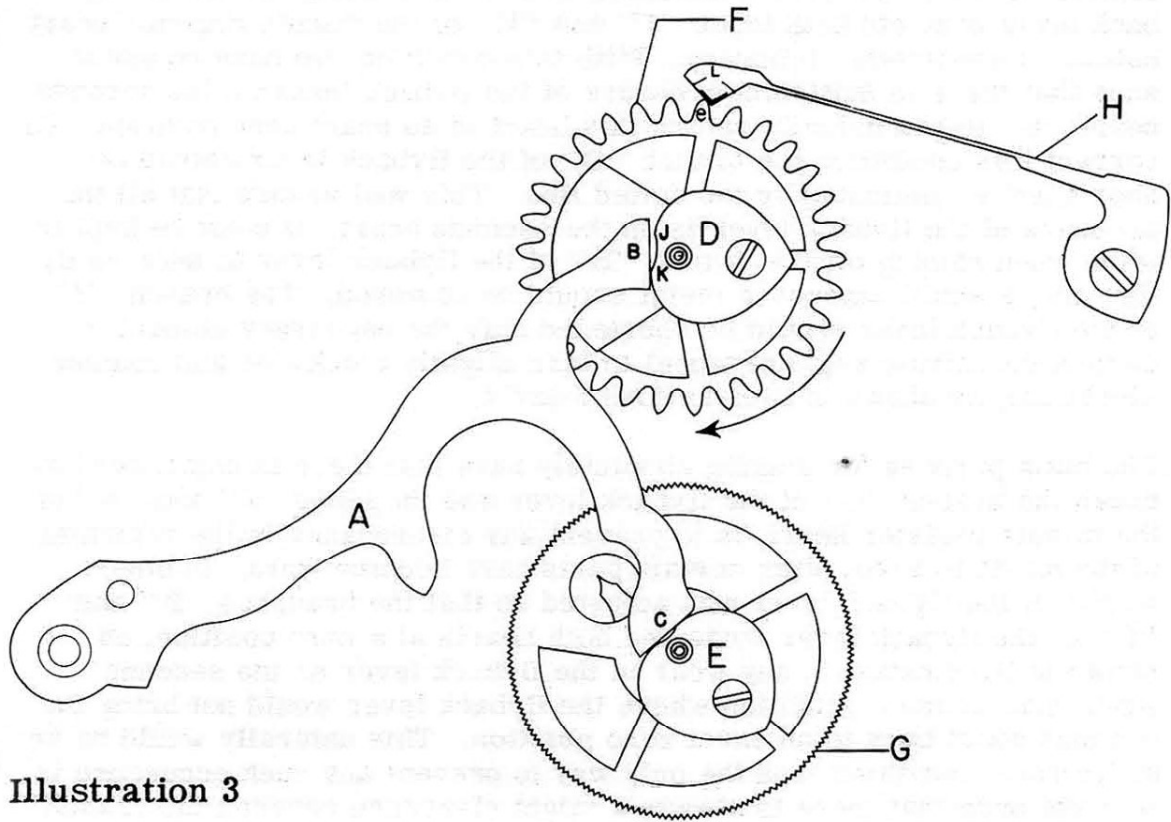

Illustration 3



When turning the minute register wheel with a fine broach in the opposite direction, (counter-clockwise), the tooth "b" of the minute register wheel should also slide up approximately one-half the working surface of the minute register pawl before the lobe "J" of the heart contacts the flyback lever. This is shown in Illustration 4.

With the flyback lever functioning on the hearts, as shown in Illustrations 3 and 4, it is assured that the back to zero function is performed with correctness, because the flyback lever will bring the seconds heart to an exact zero position, and will bring the minute register heart to a position where the end "O" of the minute register pawl, by centering itself between two teeth of the minute register wheel, can return the minute register heart to an exact zero position.

### REPAIR OF THE FLYBACK LEVER

In Illustrations 1, 2, 3, and 4, we have shown the correct function of the flyback lever in returning the seconds heart and minute register heart to zero. Now in the following Illustrations, 5, 6, 7, and 8, we show various unfavorable conditions in the returning to zero function of the flyback lever, along with the correction for each. This will give the repairman a working knowledge that will enable him to make repairs that may be necessary to restore the proper functioning of the flyback lever in returning of the hearts to zero.

In Illustration 5, we show a condition where the branch "B" of the flyback lever contacts both lobes "J" and "K" of the minute register heart, holding it absolutely stationary. With this condition, we have no assurance that there is sufficient pressure of the flyback lever on the seconds heart "E" to consistently return this heart to an exact zero position. To correct this condition, the branch "B" of the flyback lever should be shortened, as indicated by the dotted line. This will assure that all the pressure of the flyback lever is on the seconds heart. It must be kept in mind when stoning off the branch "B" of the flyback lever to shorten it, that only a small amount of metal should be removed. The branch "B" of the flyback lever should be shortened only the necessary amount to permit the minute register wheel to turn slightly clockwise and counter-clockwise, as shown in Illustrations 3 and 4.

The main purpose for making absolutely sure that there is clearance between the branch "B" of the flyback lever and the lobes "J" and "K" of the minute register heart, is to prevent any discrepancy in the returning of the hands to zero, after certain parts have become worn. In other words, if the flyback lever was adjusted so that the branches "B" and "C" of the flyback lever contacted both hearts at a zero position, as shown in Illustration 5, any wear in the flyback lever or the seconds wheel may cause a condition where the flyback lever would not bring the seconds heart back to an exact zero position. This naturally would be an undesirable condition, and the only way to prevent any such occurrence is to make sure that there is always a slight clearance between the branch "B" of the flyback lever and the minute register heart when the seconds

- A - Flyback lever
- B - Flyback lever branch
- C - Flyback lever branch
- D - Minute register heart
- E - Seconds heart
- F - Minute register wheel
- G - Seconds wheel
- H - Minute register pawl
- J - Lobe of heart
- K - Lobe of heart
- L - Inclined plane of minute register pawl

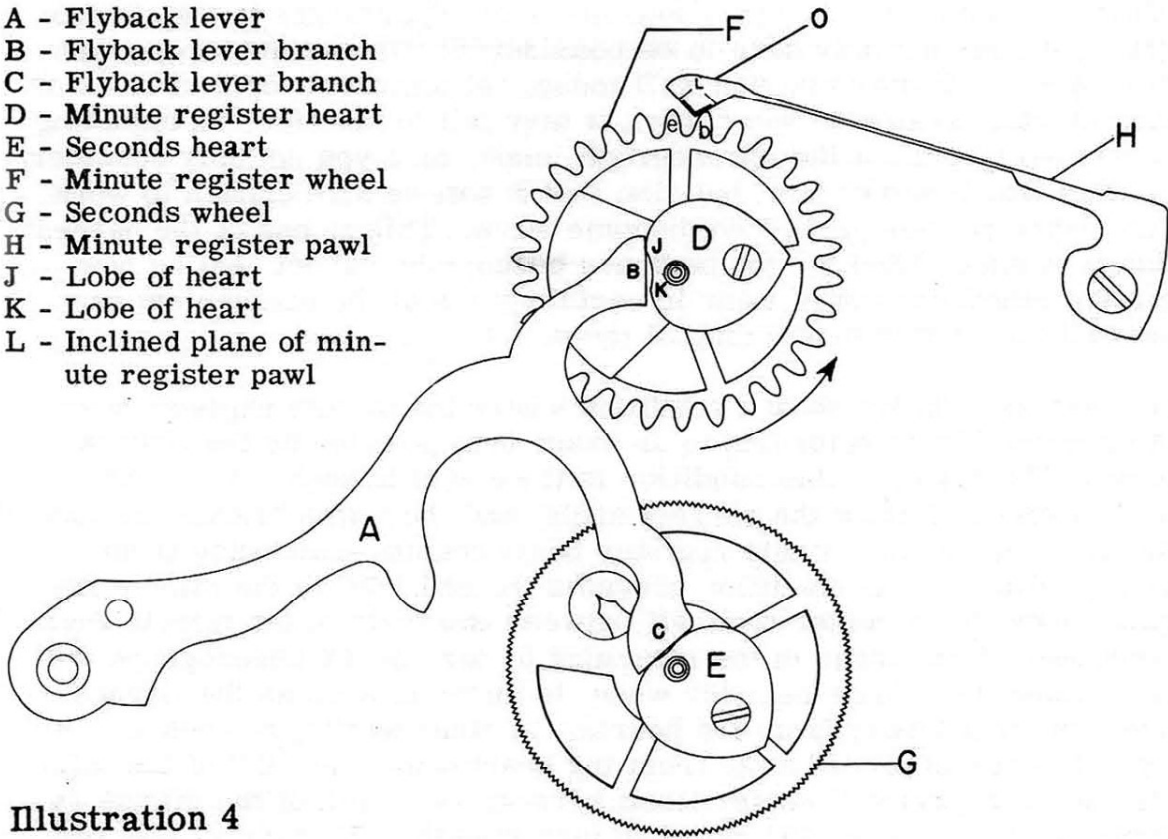

Illustration 4

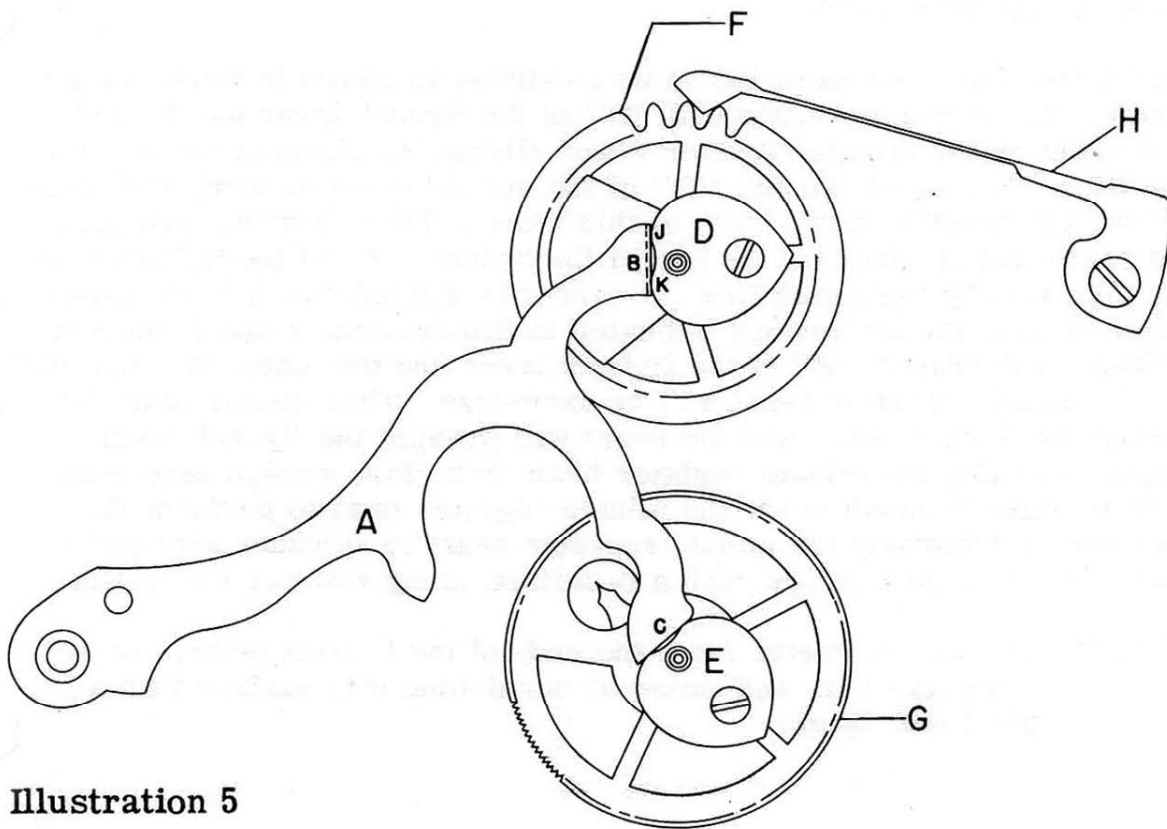

Illustration 5

heart is at an exact zero position. In most adjustments in the chronograph, it does not only have to be considered; "Does the chronograph work now?" It may function well today, but tomorrow or next week or next month, because of wear, etc., it may fail to function. In adjusting nearly every part of the chronograph, make sure you not only consider the fact that it works now, but also that it will be safe enough to work later when certain parts have become worn. This is one of the hardest things to understand for the beginner because he cannot realize how much a slight amount of wear in certain parts of the mechanism can prevent the proper functioning of the parts.

In Illustration 6, we show a condition where the minute register heart is prevented from returning to an exact zero position by the flyback lever. The cause of this condition is the end of branch "B" of the flyback lever not having the correct angle, and thus, this branch has forced the lobe "K" of the minute register heart counter-clockwise from a zero position. This condition prevents the end "O" of the minute register pawl from centering itself between two teeth of the minute register wheel. This error in the returning to zero of the chronograph will also cause the minute register wheel to move as soon as the flyback lever is forced away from the hearts. In other words, as soon as the flyback lever is forced away from the hearts, the end "O" of the minute register pawl will center itself between two teeth of the minute register wheel, causing this wheel to turn slightly. To correct this condition, the branch "B" of the flyback lever must be changed, as indicated by the dotted line.

In Illustration 7, we show the same condition as shown in Illustration 6, except that in this case, the end "B" of the flyback lever has forced the heart on the minute register wheel slightly clockwise from a zero position, preventing the end "O" of the minute register pawl from centering itself between two teeth of this wheel. This condition will also be corrected by changing the end of the branch "B" of the flyback lever, as indicated by the dotted line. It cannot be evaded that in most cases, after making the alterations indicated in Illustrations 6 and 7, the space between the branch "B" of the flyback lever and the lobes "J" and "K" of the minute register heart will be excessive. This excess space between the flyback lever and the heart will prevent the flyback lever from returning the minute register heart to a close enough zero position to make it possible for the minute register pawl to perform its function in returning the minute register heart to an exact zero position. Illustration 8 shows such a condition, along with the correction.

NOTE: To remove metal from the ends of the flyback lever, use an Arkansas slip, and finish by burnishing this surface with a pivot burnisher.

- A - Flyback lever
- B - Flyback lever branch
- C - Flyback lever branch
- D - Minute register heart
- E - Seconds heart
- F - Minute register wheel
- G - Seconds wheel
- H - Minute register pawl
- J - Lobe
- K - Lobe

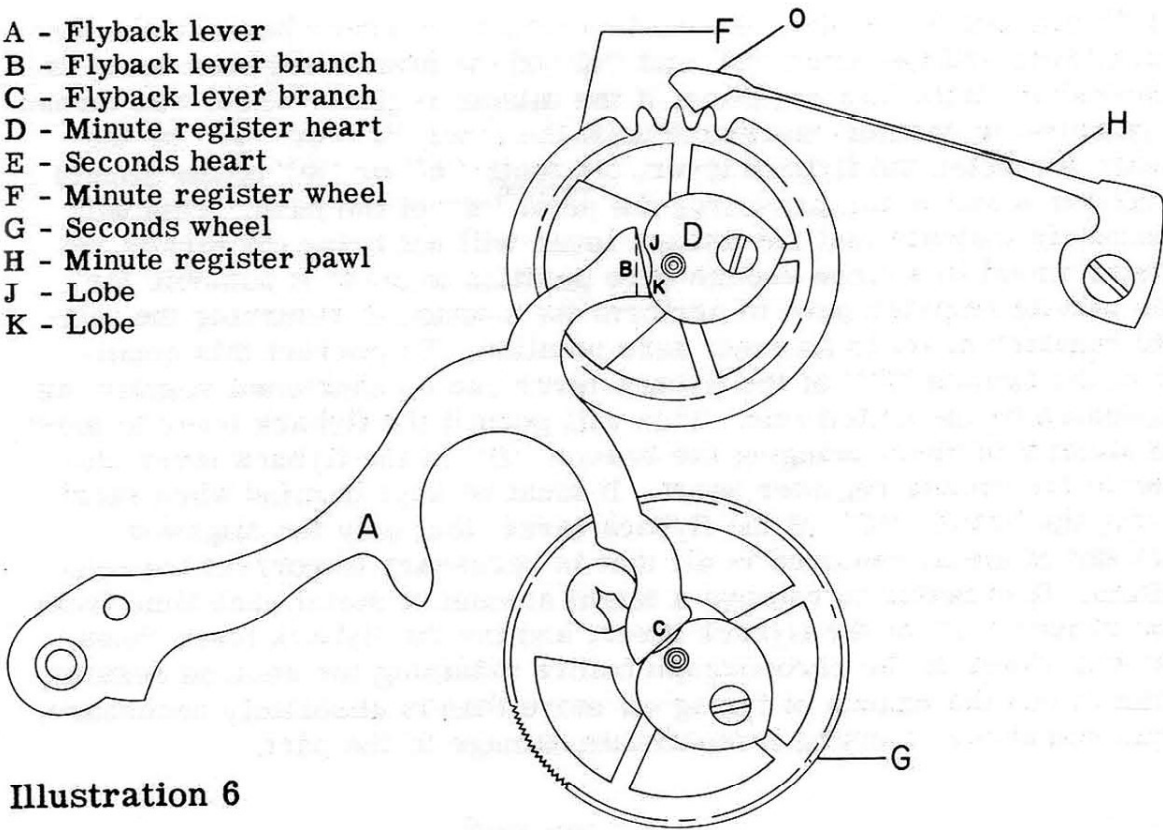

Illustration 6

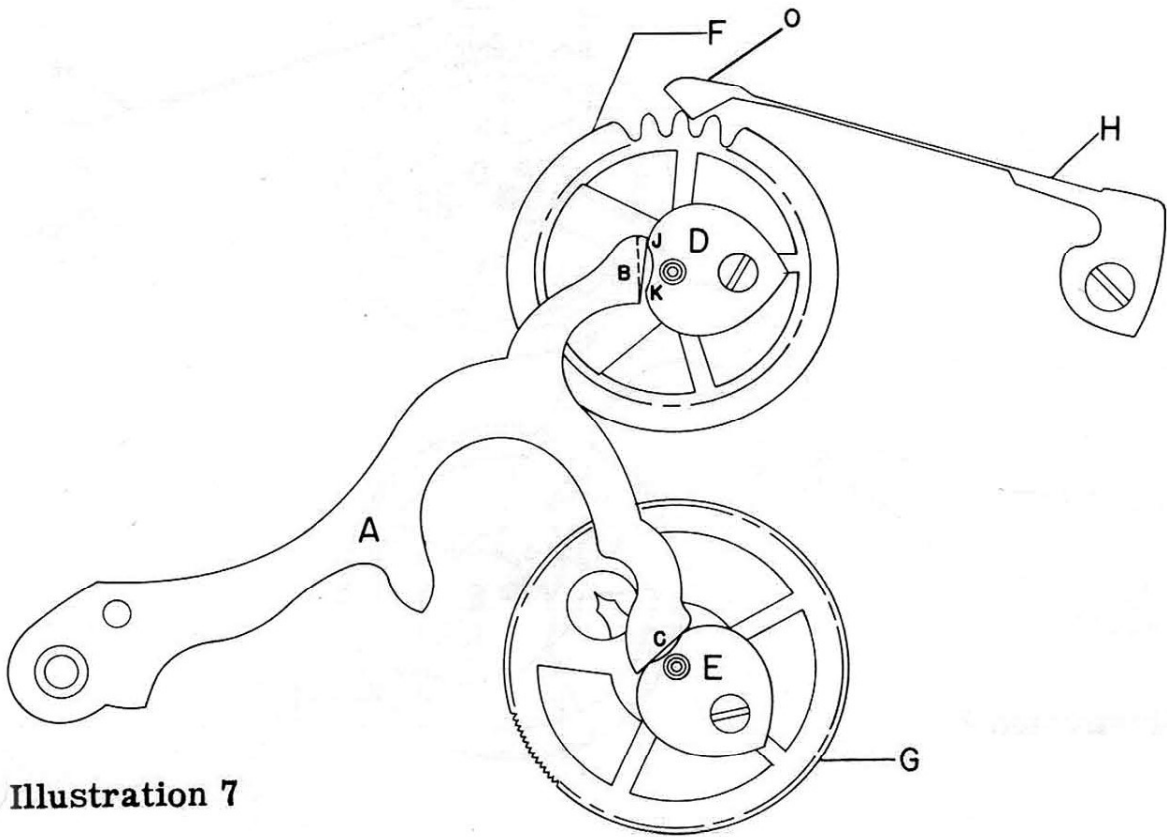

Illustration 7



In Illustration 8, we show a condition where the space between the flyback lever and the lobes "J" and "K" of the minute register heart is excessive. With this condition, if the minute register wheel was turned clockwise or counter-clockwise until the lobes "J" or "K" of the heart contacted the flyback lever, the tooth "e" or "b" of the minute register wheel would pass over the point "d" of the pawl. This will definitely indicate that the flyback lever will not bring the minute register wheel to a close enough zero position to make it possible for the minute register pawl to perform its function in returning the minute register heart to an exact zero position. To correct this condition, the branch "C" of the flyback lever can be shortened slightly, as indicated by the dotted line. This will permit the flyback lever to move in slightly further, bringing the branch "B" of the flyback lever closer to the minute register heart. It must be kept in mind when shortening the branch "C" of the flyback lever, that only the slightest amount of metal removed is all that is necessary to correct the condition. It is better to remove a slight amount of metal each time from the branch "C" of the flyback lever, and try the flyback lever three or four times in the chronograph before obtaining the desired results, than to run the chance of taking off more than is absolutely necessary, thus sometimes causing irreparable damage to the part.

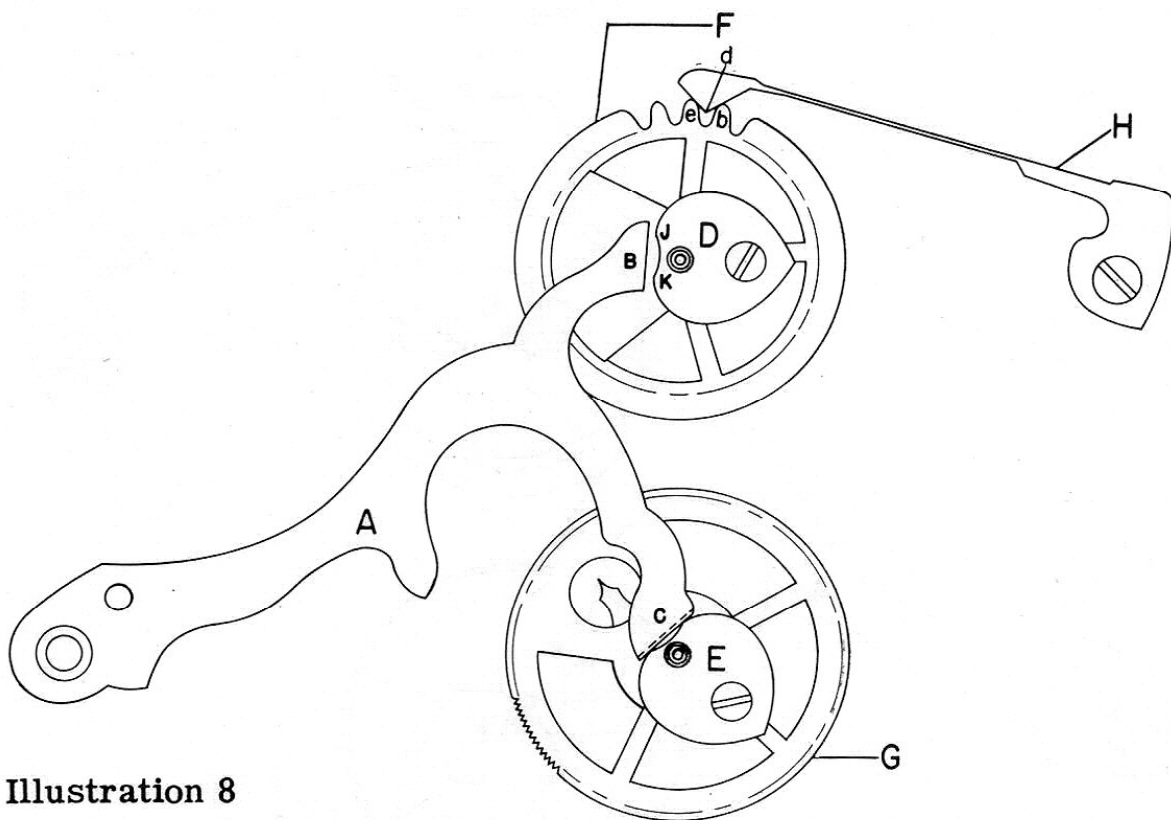

Illustration 8

Under certain conditions, as previously explained, it is sometimes necessary to shorten the branch "C" of the flyback lever. This shortening of the branch of the flyback lever will cause this branch to change its position on the heart. The changed position of the branch of the flyback lever on the heart, due to it being shortened, is shown in Illustrations 9-A and 9-B.

In Illustration 9-A, we show the branch "C" of the flyback lever centered on the lobes "F" and "G" of the heart. The branch of the flyback lever as yet has not been shortened. Now as the branch "C" of the flyback lever is shortened, as indicated by the dotted line, the branch of the flyback lever will take the position on the heart as shown in Illustration 9-B. It can be seen by comparing Illustration 9-A with 9-B, that as the branch of the flyback lever is shortened, it shifted off center on the lobes "F" and "G" of the heart. It must also be kept in mind when removing metal from the branch of the flyback lever, that if too much metal is removed, the branch of the flyback lever will no longer set across the lobes "F" and "G" of the heart. Thus, this branch will no longer return the heart to an exact zero position. Of course, under ordinary conditions, when the branch of the flyback lever needs shortening only slightly, as shown in Illustration 8, the displacement of the branch on the heart would be very slight, causing no error in the return of the heart to a zero position.

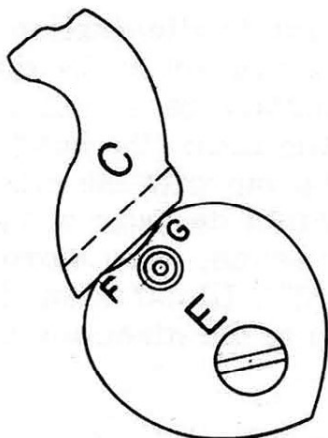

Illustration 9-A

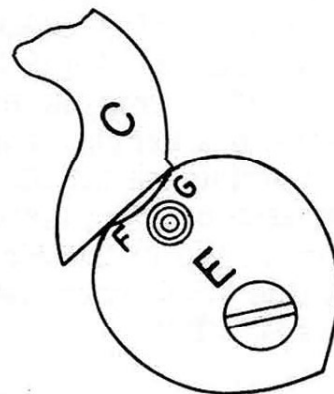

Illustration 9-B

C - Branch of Flyback Lever  
E - Heart

F - Lobe of Heart  
G - Lobe of Heart

## CHECKING THE RETURNING TO ZERO ACTION OF THE FLYBACK LEVER ON THE HEART

The hearts in a chronograph, to function properly, must be highly polished and perfectly shaped, with no flat spots or burrs. Although the hearts are checked before the chronograph is assembled, many times a slight defect in the heart is overlooked. It is advisable to make the following test to insure the correctness of the heart and the returning to zero function.

Turn the heart to a position that in order to return to zero, it will have to make approximately  $\frac{1}{2}$  a revolution, as shown in Illustration 10. Now place a piece of pegwood alongside the hand "D", so that when the flyback lever contacts the heart to force the heart and hand to turn, the pegwood will hold back the turning of the hand, also holding back the turning of the heart. Now gradually leave the hand and heart return to zero. With the pressure of the flyback lever on the heart, if at any place the hand and heart stop turning before they are returned to zero, it will usually indicate that there is a flat spot or burr on the heart which is preventing the heart from being returned to zero.

## REMOVING A FLAT SPOT ON A HEART

To remove a flat spot on a heart, such as shown in Illustration 11, mix a compound of Arkansas oil stone powder with oil to the thickness of a paste. Apply this mixture to the surface of a bell metal lap. Then grip the heart in a hand vise, and brace the heart on the edge of a bench. Then place the bell metal lap with the mixture of Arkansas oil stone powder and oil against the edge of the heart, also bracing the lap on the edge of the bench. Now move the bell metal lap in the direction of the arrow "E", Illustration 12, and at the same time swing the bell metal lap in the direction of the arrow "F".

Now slide the bell metal lap in the opposite direction, as indicated in Illustration 13 by the arrow "G", at the same time, swinging the lap in the direction of the arrow "H". Continue this motion of lapping the heart until the flat spot on the heart is removed. Now the edge of the heart should be polished. To polish the edge of the heart, mix a compound of diamontine grade 2, and oil to the thickness of a paste. Apply this mixture to a boxwood slip. Then place the boxwood slip against the edge of the heart, and again use the same motion on polishing the heart as shown in Illustrations 12 and 13.

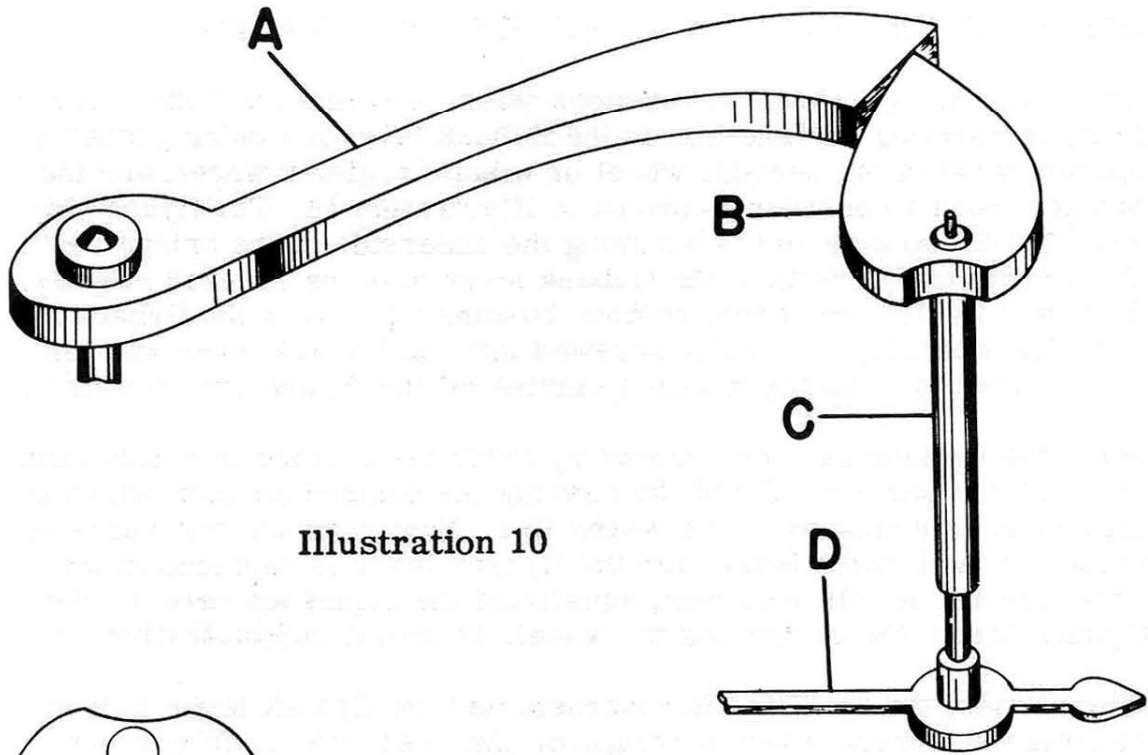

Illustration 10

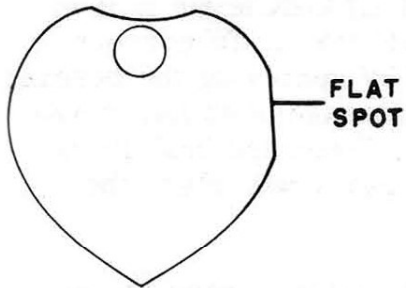

Illustration 11

- A - Flyback lever
- B - Heart
- C - Staff
- D - Hand

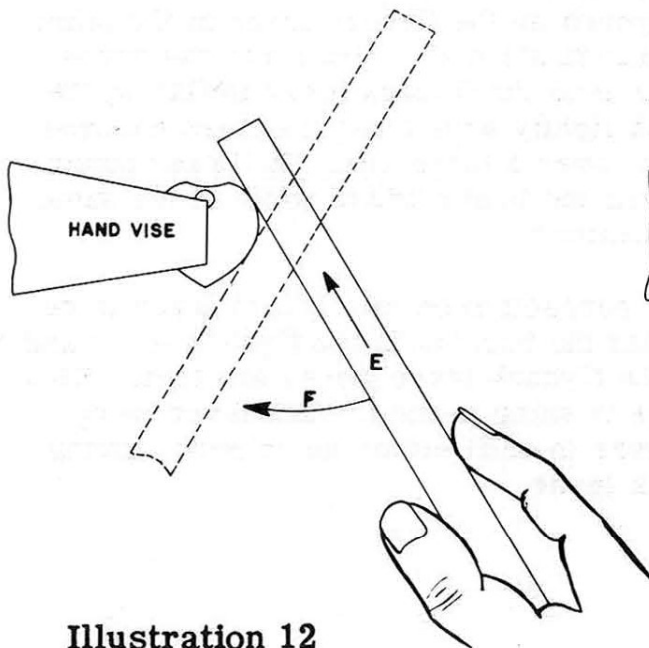

Illustration 12

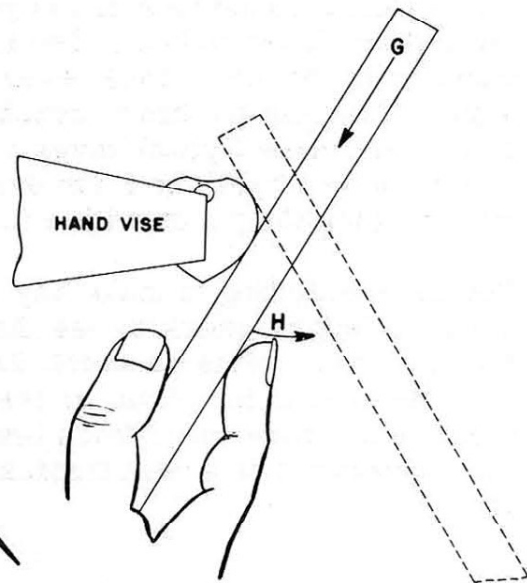

Illustration 13



## ADJUSTING THE FLYBACK LEVER FOR PROPER HEIGHT

One of the most common occurrences which prevents the flyback lever from performing its function, is the flyback lever not being properly spaced between the seconds wheel or minute register wheel, and the bridge. Such a condition is shown in Illustration 14. The flyback lever "E" is too high and is scraping the underside of the bridge "H". To correct this condition, the flyback lever must be lowered slightly. To lower the flyback lever, remove bushing "B" from the flyback lever. This bushing is usually screwed into the flyback lever and can be removed by gripping it with a pinvise or chuck, and unscrewing it.

After the bushing has been removed, chuck the bushing in a lathe, and cut back the surface "C" of the bushing the desired amount, which in this case, is indicated by the dotted line. Now when the bushing is replaced in the flyback lever, and the flyback lever is replaced in the chronograph, it will set lower, equalizing the clearance between the flyback lever, the bridge and the wheel, as shown in Illustration 15.

Many times, the condition is reversed, and the flyback lever is low, causing the flyback lever to scrape on the wheel "F". To correct this condition, the flyback lever can be raised by removing the bushing "B" from the flyback lever and placing a small washer on the shoulder of the bushing, as shown in Illustration 16. When the bushing is replaced, the flyback lever will be raised, so that it will clear the wheel "F" without scraping.

More often, the condition causing the flyback lever to scrape on the bridge or wheel, is caused by the flyback lever being bent. To straighten a flyback lever that is bent, place the flyback lever on a lead anvil. Place a round face brass punch on the flyback lever at the point the flyback lever is bent. See Illustration 17. Now force the brass punch down on the flyback lever until the flyback lever is flat on the anvil. Then tap the brass punch lightly with a watchmakers hammer. If the bend in the flyback lever is over a large area, the brass punch can be moved back and forth over the bent surface while at the same time tapping the punch with a hammer.

Before proceeding to make any correction on the flyback lever in regards to height, check to see that the bushing in the flyback lever and the post in the plate on which the flyback lever pivots are tight. Either the post in the plate, or the bushing in the flyback lever being loose, will cause the flyback lever to shift either up or down, giving the appearance of a bent flyback lever.

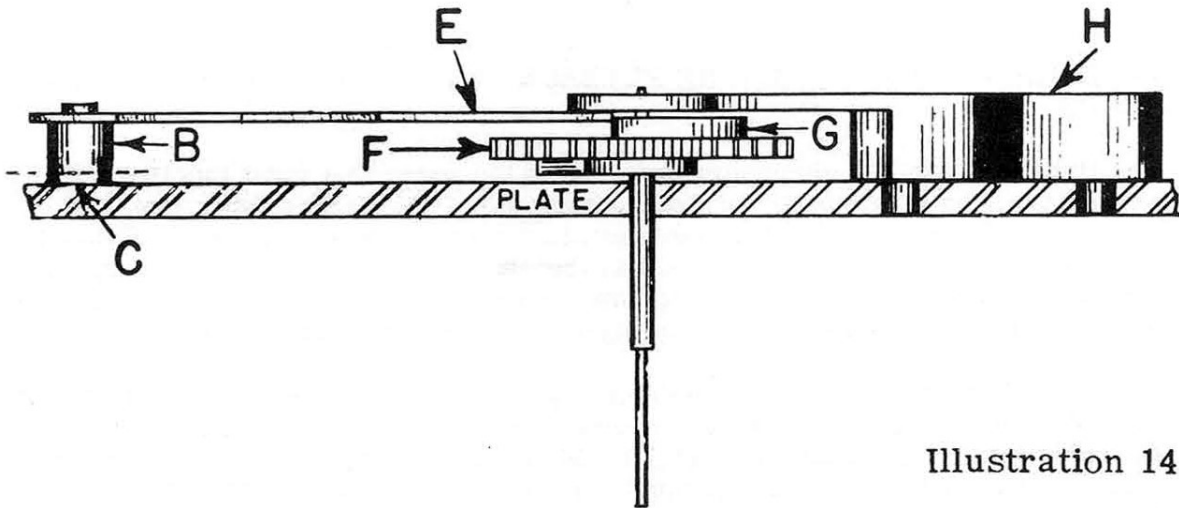

Illustration 14

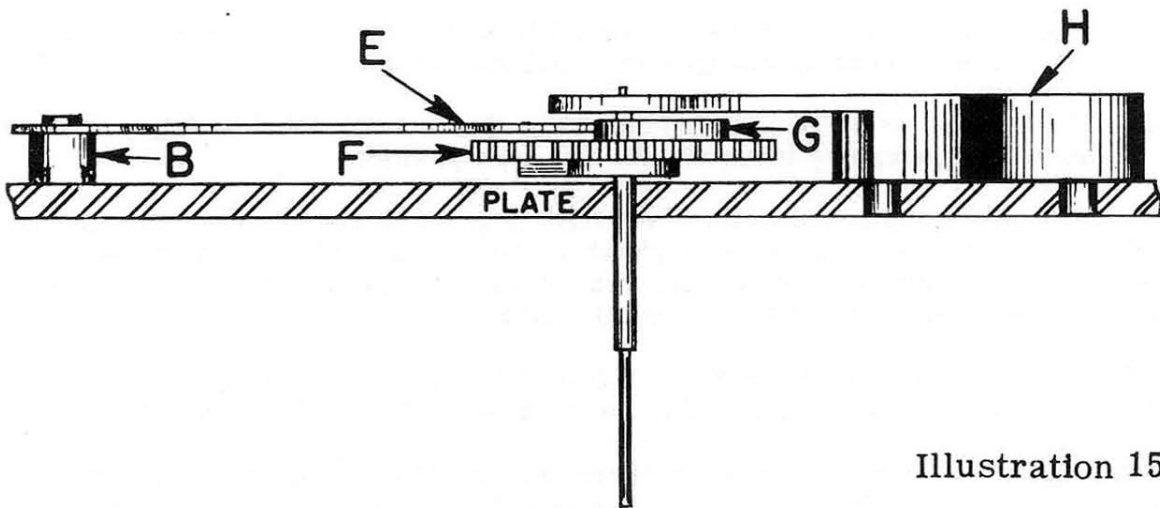

Illustration 15

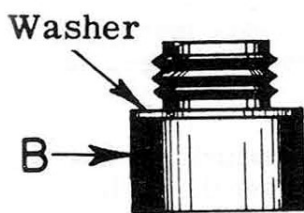

Illustration 16

- B - Bushing
- E - Flyback lever
- F - Wheel
- G - Heart
- H - Bridge
- J - Brass punch

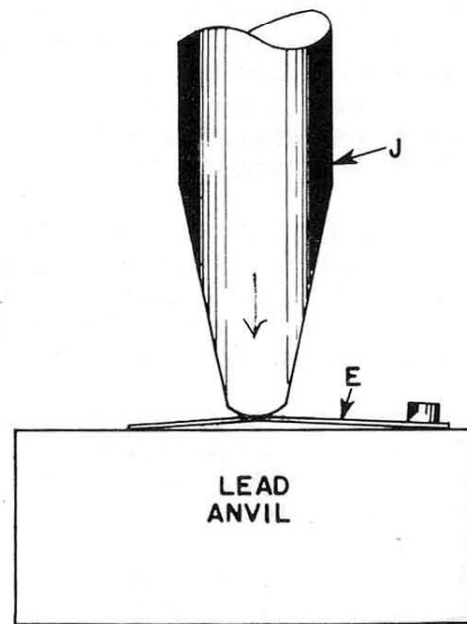

Illustration 17

## PART 2

### FUNCTION AND REPAIR OF THE FLYBACK LEVER IN A 2 BUTTON CHRONOGRAPH

The flyback lever in a chronograph is one of the parts that must function with exactness. Any error in the proper functioning of the flyback lever can, and usually does cause an error in the registration on the dial. Due to the flyback lever playing such an important part in the proper function of the chronograph, it would be well worth while to study the complete function of the various arrangements of flyback levers, their advantages, disadvantages, and repair.

It must be kept in mind that the flyback lever performs more functions than just the returning of the hearts on the seconds wheel and minute register wheel to a zero position, as explained in Part 1 in this book. In fact, that is usually the last function of the flyback lever. Generally speaking, the flyback lever performs its functions in the following sequence. See Illustration 18.

1. The flyback lever disengages the brake lever "E" from the seconds wheel "A".
2. The flyback lever disengages the intermittent wheel "O" from the dart tooth "N".
3. The flyback lever contacts the hearts on the seconds wheel and minute register wheel, returning these wheels to a zero position.

To follow the complete function of the flyback lever as listed above, we will start with the flyback lever in a negative position, away from the hearts on the seconds wheel and minute register wheel, and follow the function of the flyback lever step-by-step, as it is moved towards the hearts.

### FUNCTION OF THE FLYBACK LEVER AS IT IS MOVED TOWARDS THE HEARTS ON THE SECONDS WHEEL AND MINUTE REGISTER WHEEL

Illustration 18 shows the flyback lever in a negative position, away from the hearts on the seconds wheel and minute register wheel. Now as pressure is applied to the button "H", the push piece "G" will pivot, and force the flyback lever to move in the direction towards the hearts. This movement of the flyback lever will cause the surface "J" of the flyback lever to force the pin "I" of the brake lever to move in the direction of the arrow. Thus, the brake lever will pivot, disengaging the end "K" of the brake lever from the seconds wheel, as shown in Illustration 19.

Next, as the flyback lever is forced further in the directions towards the hearts, the surface "L" of the flyback lever, Illustration 19, will contact the surface "M" of the intermittent lever, and force the intermittent lever to pivot in the direction of the arrow. This will disengage the intermittent wheel "O" from the path of the dart tooth "N", as shown in Illustration 20.

A - Seconds wheel  
B - Minute register wheel  
C - Intermittent lever  
D - Flyback lever  
E - Brake lever  
F - Flyback lever spring  
G - Push piece for setting  
back to zero

H - Chronograph push button  
N - Dart tooth  
O - Intermittent wheel  
P - Pivoting point of all parts  
R - Minute register wheel heart  
S - Seconds wheel heart  
T - Intermittent lever spring  
U - Brake lever spring

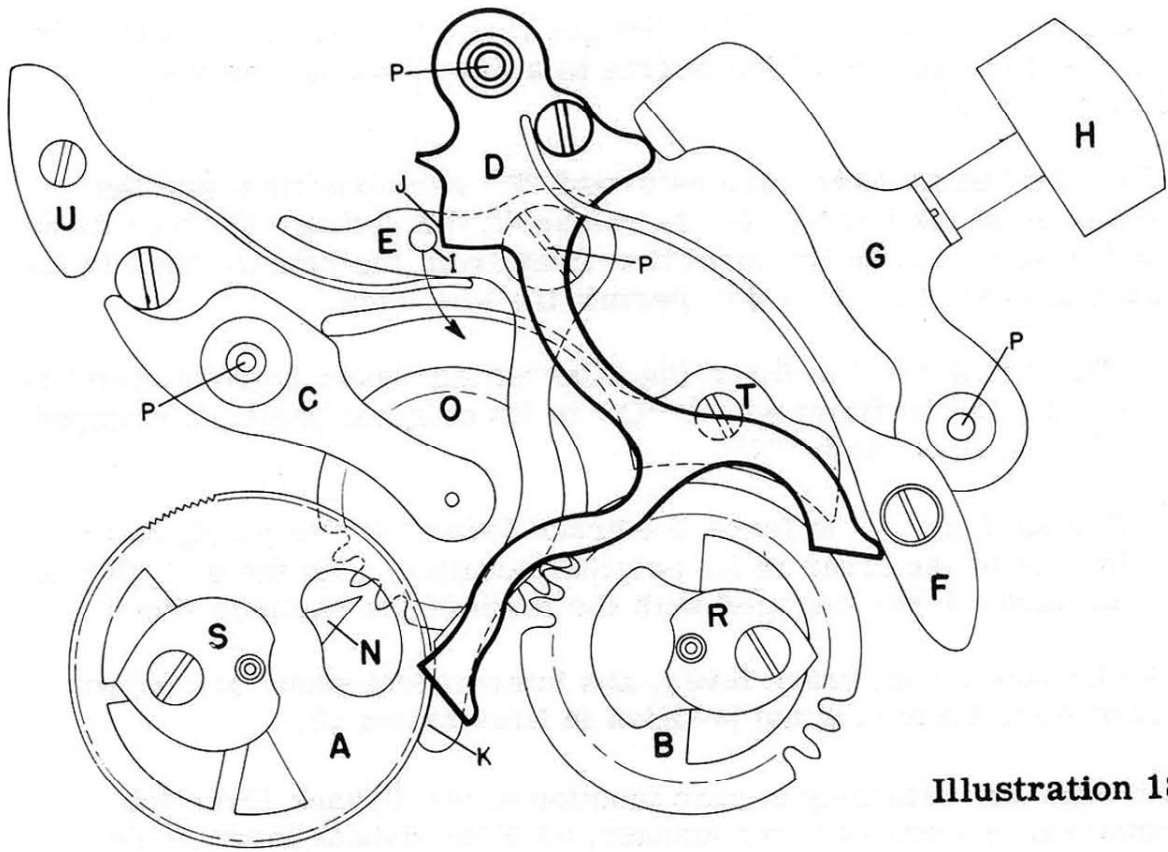

Illustration 18

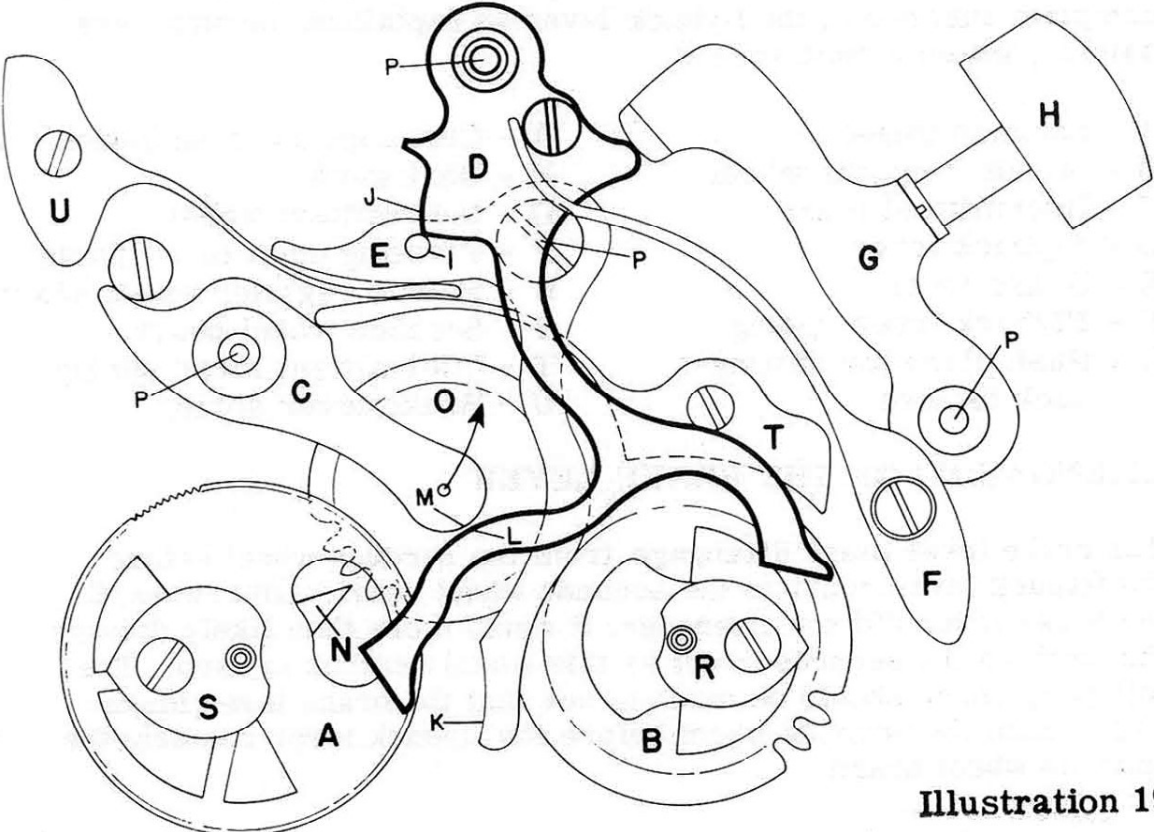

Illustration 19



Then, the last function of the flyback lever is performed, which is the complete return of the hearts to a zero position, as shown in Illustration 21.

After the hearts have been returned to a zero position, and the pressure on the button "H" is released, the spring "F" will force the flyback lever in the direction away from the hearts, back to its original position. This will permit the following:

1. The spring "T" to force the intermittent lever to pivot, returning the intermittent wheel "O" to its original position, engaged with the dart tooth "N".
2. The spring "U" to force the brake lever "E" to pivot, returning the brake lever to its original position, with the end "K" of the brake lever engaged with the teeth of the seconds wheel.

The flyback lever, brake lever, and intermittent wheel are shown returned to their original position in Illustration 18.

Although the returning to zero function of the flyback lever was explained in a step-by-step manner, as if the flyback lever would move in slowly to contact the hearts, it must be understood that the complete function of the flyback lever as explained, occurs very quickly, within a split second.

A - Seconds wheel	H - Chronograph push button
B - Minute register wheel	N - Dart tooth
C - Intermittent lever	O - Intermittent wheel
D - Flyback lever	P - Pivoting point of all parts
E - Brake lever	R - Minute register wheel heart
F - Flyback lever spring	S - Seconds wheel heart
G - Push piece for setting back to zero	T - Intermittent lever spring
	U - Brake lever spring

#### DISENGAGING OF THE BRAKE LEVER

The brake lever must disengage from the seconds wheel before the flyback lever contacts the seconds wheel heart. Otherwise, if the brake lever did not disengage, it would more than likely damage the teeth on the seconds wheel as this wheel returns to zero. The following check should be made to see that the brake lever disengages from the seconds wheel before the flyback lever contacts the seconds wheel heart:

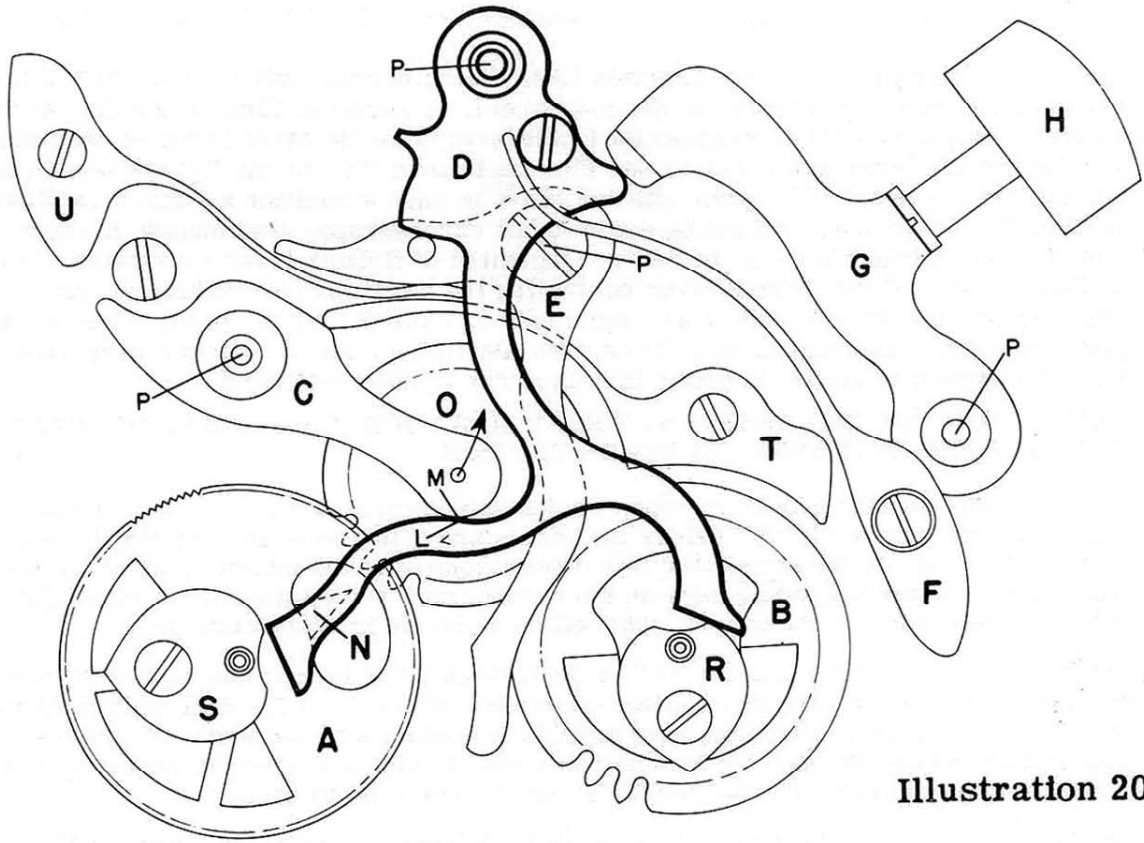

Illustration 20

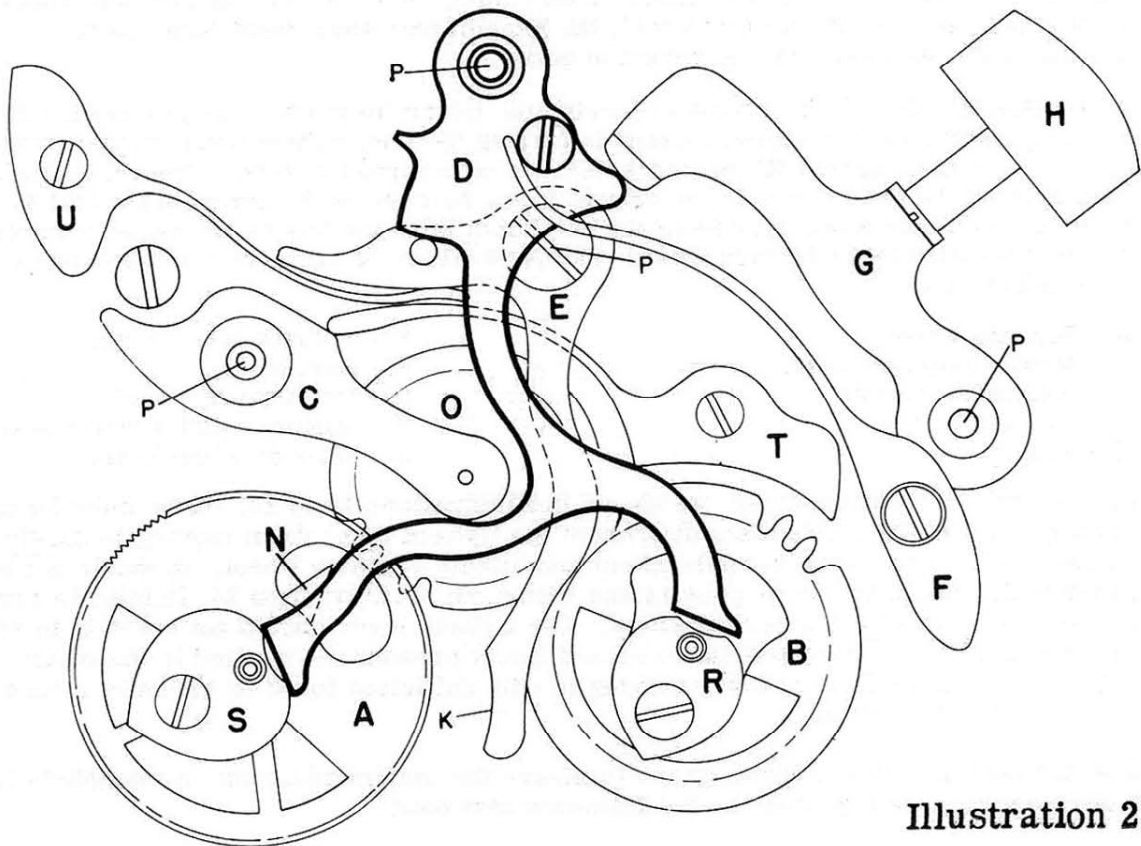

Illustration 21

## CHECKING FOR THE PROPER DISENGAGEMENT OF THE BRAKE LEVER

Move the flyback lever in the direction towards the hearts until the end "K" of the brake lever disengages from the seconds wheel, as shown in Illustration 22. At the instant the flyback lever disengages the brake lever from the seconds wheel, stop moving the flyback lever and check to see that the branch "Y" of the flyback lever cannot contact the heart "S", even with the heart in such a position as shown in Illustration 22. (This check should be made on all chronographs that include in their construction a brake lever.) In this arrangement of flyback lever illustrated, there is little danger of the flyback lever contacting the heart before the brake lever is disengaged. But in some other arrangements of flyback levers, this function is not performed with such exactness. Thus, this function should be checked very carefully, as explained above, in order that an error is not overlooked.

## THE REASON THE INTERMITTENT WHEEL MUST DISENGAGE FROM THE DART TOOTH IN THE RETURNING TO ZERO FUNCTION

As previously explained in Illustration 20, the intermittent wheel "O" should disengage from the dart tooth "N" before the hearts are returned to zero by the flyback lever. To illustrate the reason for this disengagement of the intermittent wheel, we will show what effect it would have on the chronograph if the intermittent wheel did not disengage from the dart tooth. This effect is shown in Illustration 23.

Illustration 23 shows the branch "Y" of the flyback lever forcing the heart "S" and the dart tooth "N" to turn in a counter-clockwise direction. (The dart tooth is firmly attached to the heart.) Since the dart tooth is in contact with the tooth "X" on the intermittent wheel, the dart tooth must force the intermittent wheel to turn in a clockwise direction in order that the heart "S" can be returned to zero.

On the other hand, the branch "Z" of the flyback lever is forcing the heart "R" and the minute register wheel in a clockwise direction. Since the minute register wheel is engaged with the intermittent wheel, the intermittent wheel must turn counter-clockwise for the heart "R" to return to zero.

Due to the fact that the dart tooth is forcing the intermittent wheel in a clockwise direction, and the minute register wheel is forcing the intermittent wheel in the opposite direction, neither heart "R" or heart "S" can be returned to zero. From this observation, it can be seen that it is imperative to the function of the chronograph that the intermittent wheel disengages from the dart tooth when the hearts are being returned to a zero position by the flyback lever. This will eliminate any error such as shown in Illustration 23.

A - Seconds wheel  
B - Minute register wheel  
C - Intermittent lever  
D - Flyback lever  
E - Brake lever

F - Flyback lever spring  
N - Dart tooth  
O - Intermittent wheel  
R - Minute register wheel heart  
S - Seconds wheel heart

In this type of flyback lever, as shown in Illustrations 18 to 23, there must be an arrangement in the mechanism to prevent the flyback lever from moving in slowly to contact the hearts on the seconds wheel and minute register wheel. It should not be possible for the operator by pushing the button "H", Illustration 24, lightly, to return the hearts gradually to a zero position. The flyback lever should not move in to return the hearts to a zero position until sufficient pressure is applied to the button "H" to assure the flyback lever moving in with sufficient force to instantly return the hearts to a zero position.

The arrangement in the chronograph to insure the instant returning of the hearts to a zero position, is explained on the following text page.

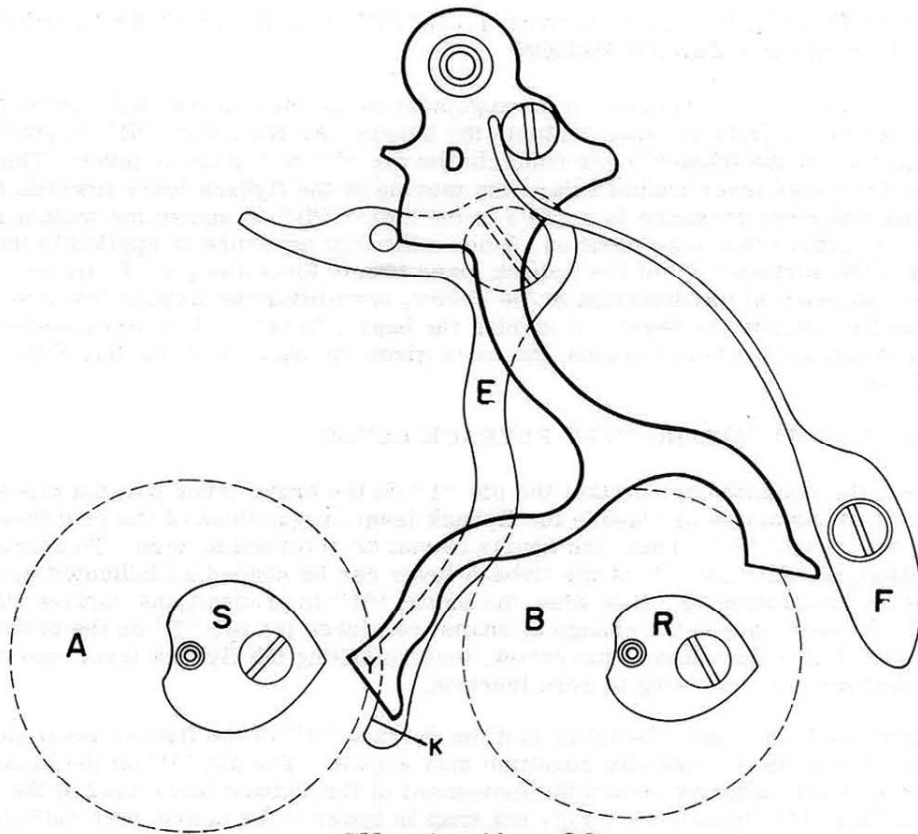

Illustration 22

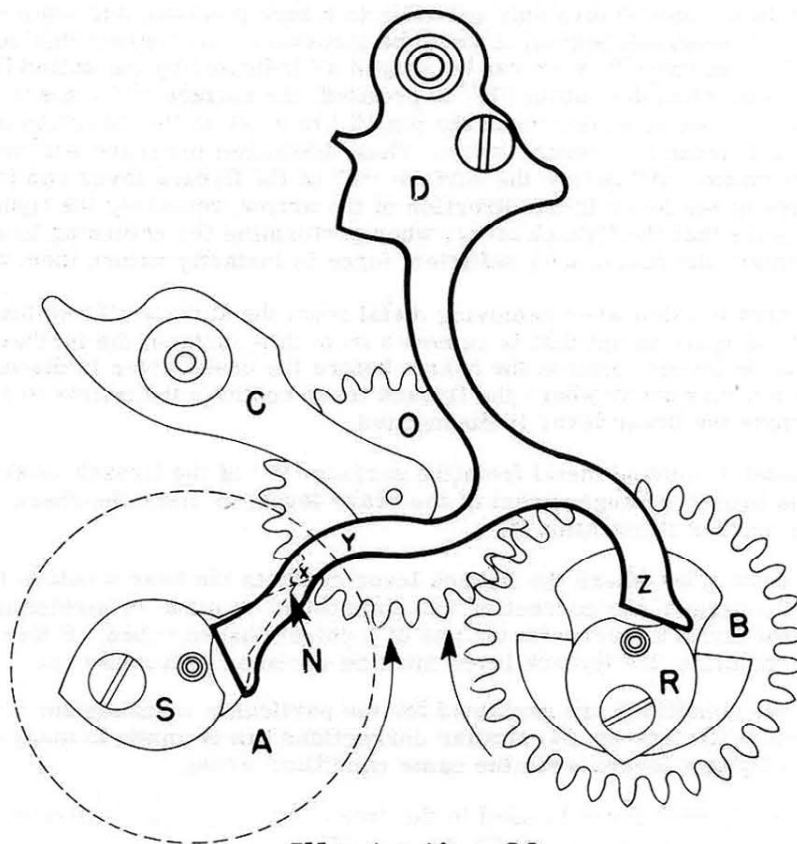

Illustration 23



## ARRANGEMENT IN THE CHRONOGRAPH TO INSURE THE INSTANT RETURNING OF THE HEARTS TO A ZERO POSITION

In Illustration 24, we can observe the arrangement in the mechanism that controls the force with which the flyback lever contacts the hearts. As the button "H" is pressed, the surface "J" of the flyback lever contacts the pin "I" on the brake lever. This pin "I" on the brake lever should retard the moving of the flyback lever towards the hearts until sufficient pressure is applied to the button "H" to insure the instant returning of the hearts to a zero position. When sufficient pressure is applied to the button "H", the surface "J" of the flyback lever should force the pin "I" on the brake lever to move in the direction of the arrow, permitting the flyback lever to move instantly towards the hearts, returning the hearts to zero. This arrangement of flyback lever, for obvious reasons, has been given the name of Retarding Type Flyback Lever.

### REPAIR OF THE RETARDING TYPE FLYBACK LEVER

Many times, the condition arises that the pin "I" on the brake lever will not move in the direction of the arrow to release the flyback lever, regardless of the pressure applied to the button "H". Thus, the hearts cannot be returned to zero. To correct this condition, the surface "J" of the flyback lever can be shaped as indicated by the dotted line in Illustration 25. Now when the button "H" is pressed, the surface "J" of the flyback lever, due to the change of shape, can force the pin "I" on the brake lever to move in the direction of the arrow, thus releasing the flyback lever, permitting it to perform the returning to zero function.

On the other hand, care must be taken that the surface "J" of the flyback lever is not changed too much, as the opposite condition may appear. The pin "I" on the brake lever may only very slightly retard the movement of the flyback lever toward the hearts, and thus, the flyback lever may not snap in towards the hearts with sufficient force to instantly return the seconds wheel and minute register wheel to a zero position. With this condition, if the operator of the chronograph only pushed the button "H" lightly, the hands may return only partially to a zero position, and when the registration of the chronograph begins, it would be incorrect. To correct this condition, the surface "J" of the flyback lever can be shaped as indicated by the dotted line in Illustration 26. Now when the button "H" is pressed, the surface "J", due to the change of shape, will not as easily force the pin "I" to move in the direction of the arrow in order to release the flyback lever. Thus, additional pressure will have to be applied to the button "H" before the surface "J" of the flyback lever can force the pin "I" on the brake lever in the direction of the arrow, releasing the flyback lever. This will insure that the flyback lever, when performing the returning to zero function, will contact the hearts with sufficient force to instantly return them to zero.

It must also be kept in mind when removing metal from the surface "J" of the flyback lever, that the more metal that is removed from this surface, the further the flyback lever can be forced towards the hearts before the brake lever is disengaged. Thus, the condition may occur where the flyback lever contacts the hearts to return them to zero before the brake lever is disengaged.

It is advisable after removing metal from the surface "J" of the flyback lever, in order to insure the proper disengagement of the brake lever, to make the check that is explained in the text for Illustration 22.

If the condition does arise where the flyback lever contacts the hearts before the brake lever is disengaged, the correction can sometimes be made by stretching the surface "J" of the flyback lever with the use of a chisel shaped punch. If this does not correct the condition, the flyback lever must be replaced with a new one.

Although the above conditions are explained for the particular arrangement of flyback lever shown in Illustration 24, similar corrections can be made in many other arrangements of flyback levers when the same conditions arise.

The retarding type flyback lever is used in the type of chronograph illustrated in Volumes 4, 5, 7, 8, 12, 13, 15, 17, 18, 20, 21, and 22.

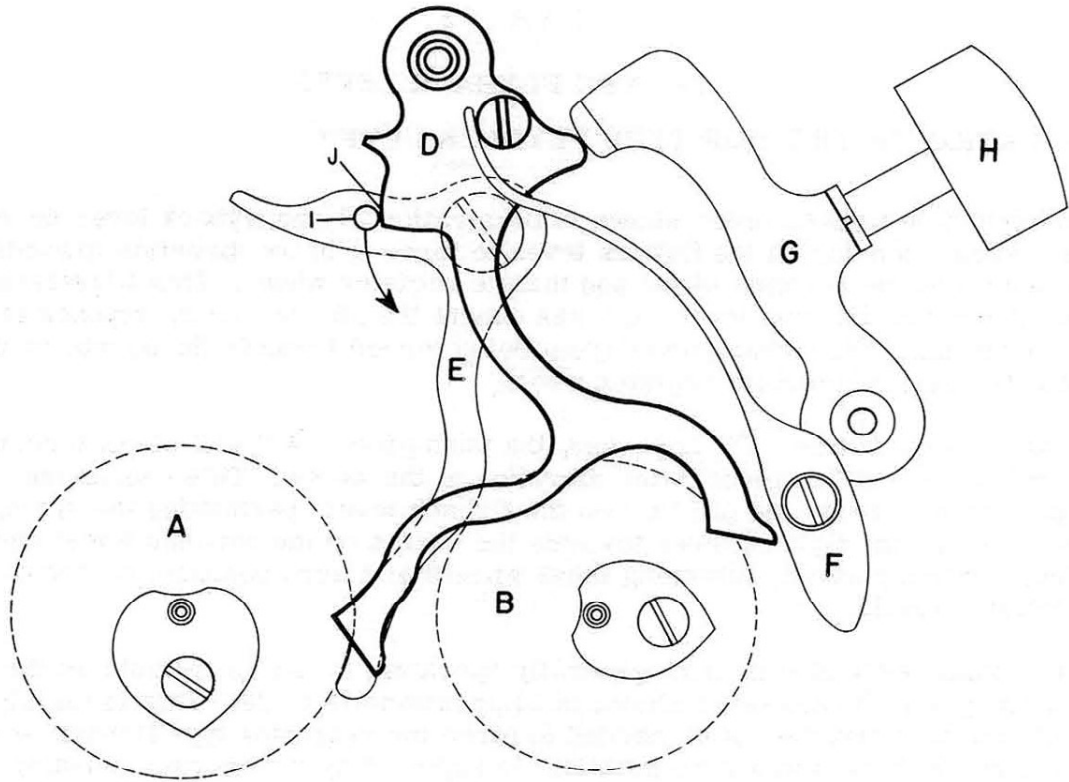

Illustration 24

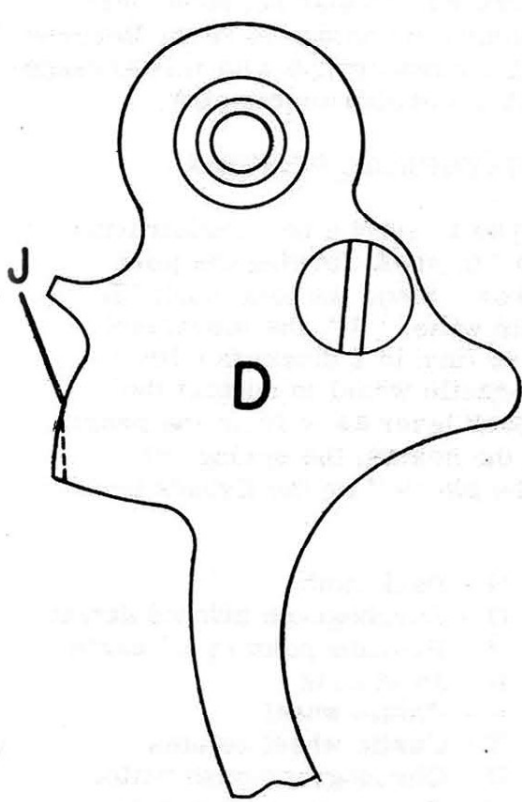

Illustration 25

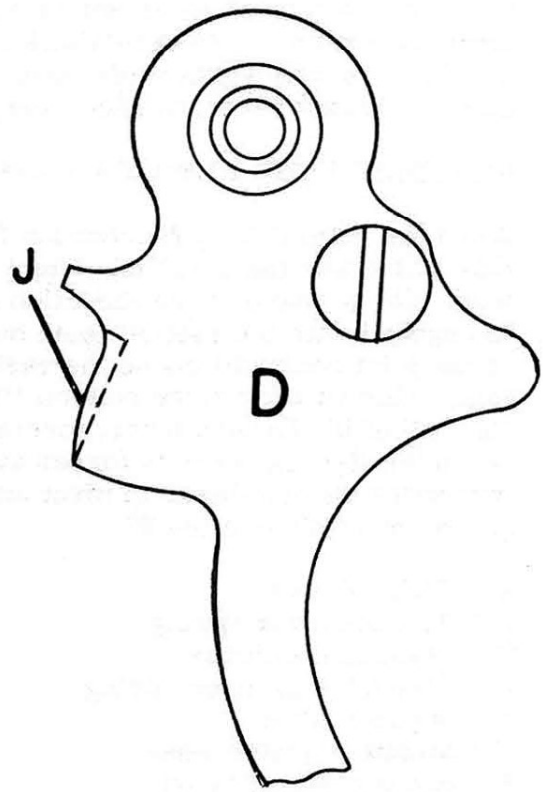

Illustration 26

## PART 3

### TRIP TYPE FLYBACK LEVER

#### OPERATION OF THE TRIP TYPE FLYBACK LEVER

In the trip type flyback lever, shown in Illustration 27, the flyback lever spring "B" holds a tension on the flyback lever to force it in the direction towards the hearts on the seconds wheel and minute register wheel. This illustration also shows that the trip lever "C" has caught the pin "e" on the flyback lever, preventing the flyback lever from being forced towards the hearts on the seconds wheel and minute register wheel.

As soon as the button "V" is pushed, the push piece "W" will pivot, forcing the trip lever "C" to pivot in the direction of the arrow. This causes the trip lever to release the pin "e" on the flyback lever, permitting the spring "B" to force the flyback lever towards the hearts on the seconds wheel and minute register wheel, returning these wheels to a zero position, as shown in Illustration 28.

The flyback lever of this type, generally speaking, is not as reliable as the retarding type flyback lever shown in Illustrations 18 to 26. This is mainly due to the fact that the power needed to force the retarding type flyback lever to return the hearts to a zero position, is supplied by the operator pushing the button, while in the trip type flyback lever, the power that is needed to force the flyback lever to return the hearts to zero, is supplied by the flyback lever spring. Many times, because of various conditions, as we will later mention, the flyback lever spring "B", Illustration 27, may not have sufficient strength to force the flyback lever to return the hearts to zero. Because of this, it is well worth while, when repairing a chronograph with this arrangement of flyback lever, to check very carefully its proper functioning.

#### RETURNING THE FLYBACK LEVER TO ITS ORIGINAL POSITION

When the button "U", Illustration 28, is pushed to start a new registration, this will cause the actuating detent lever "O" to pivot, forcing the joint hook "R" to move in the direction of the arrow. Since the joint hook "R" is engaged with the ratchet teeth on the castle wheel "S", the movement of the joint hook will cause the castle wheel to turn in a clockwise direction. This will force the column "T" of the castle wheel to contact the lip "r" of the flyback lever, forcing the flyback lever away from the hearts. When the flyback lever is forced away from the hearts, the spring "D" will force the trip lever to pivot and catch the pin "e" on the flyback lever, as shown in Illustration 27.

- |   |                                 |
|---|---------------------------------|
| A - Flyback lever                       | N - Dart tooth                  |
| B - Flyback lever spring                | O - Chronograph pivoted detent  |
| C - Flyback trip lever                  | P - Pivoting point of all parts |
| D - Flyback trip lever spring           | R - Joint hook                  |
| J - Seconds wheel                       | S - Castle wheel                |
| K - Minute register wheel               | T - Castle wheel column         |
| L - Seconds wheel heart                 | U - Chronograph push button     |
| M - Minute register wheel heart         | V - Chronograph push button     |
| W - Push piece for setting back to zero |                                 |

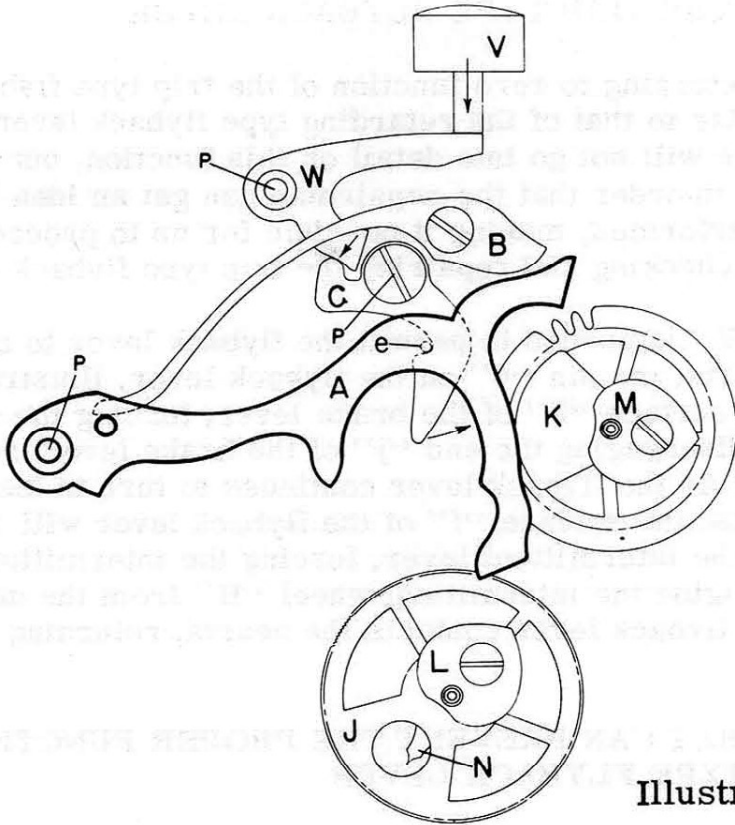

Illustration 27

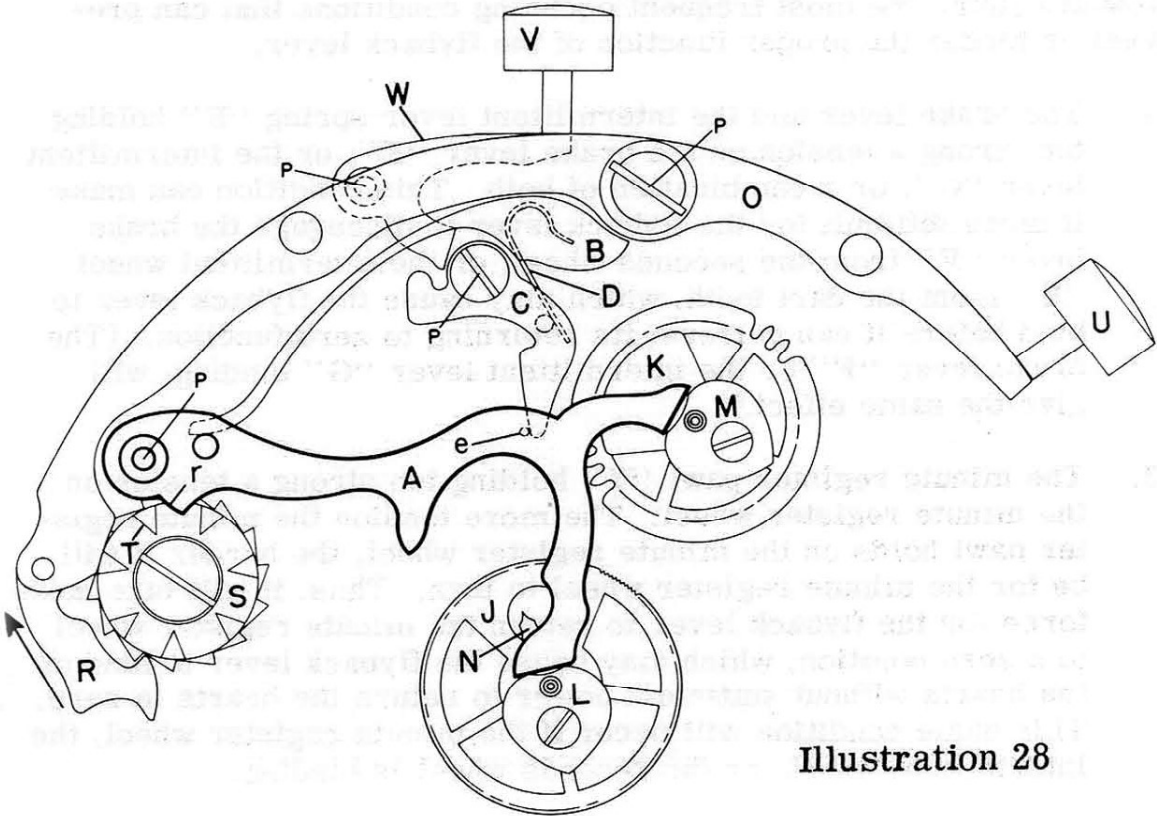

Illustration 28



## FUNCTION OF THE TRIP TYPE FLYBACK LEVER

The complete returning to zero function of the trip type flyback lever is very similar to that of the retarding type flyback lever. Because of this, we will not go into detail on this function, but merely cover it briefly in order that the repairman can get an idea how these functions are performed, making it possible for us to proceed with the "Method of checking and repairing the trip type flyback lever."

As the button "V" is pushed to permit the flyback lever to be forced towards the hearts, the pin "d" on the flyback lever, Illustration 29, will contact the surface "b" of the brake lever, forcing the brake lever to pivot, disengaging the end "j" of the brake lever from the seconds wheel. As the flyback lever continues to turn in the direction of the hearts, the surface "f" of the flyback lever will contact the pin "h" on the intermittent lever, forcing the intermittent lever to pivot, disengaging the intermittent wheel "H" from the dart tooth "N". Then the flyback lever contacts the hearts, returning them to zero.

## CONDITIONS THAT CAN PREVENT THE PROPER FUNCTIONING OF THE TRIP TYPE FLYBACK LEVER

As previously mentioned in the trip type flyback lever, there are many conditions that can prevent it from functioning properly. Below are listed the most frequent occurring conditions that can prevent or hinder the proper function of the flyback lever.

1. The brake lever and the intermittent lever spring "E" holding too strong a tension on the brake lever "F", or the intermittent lever "G", or a combination of both. This condition can make it more difficult for the flyback lever to disengage the brake lever "F" from the seconds wheel, or the intermittent wheel "H" from the dart tooth, which may cause the flyback lever to bind before it can perform its returning to zero function. (The brake lever "F" or the intermittent lever "G" binding, will give the same effect.)
2. The minute register pawl "Y" holding too strong a tension on the minute register wheel. The more tension the minute register pawl holds on the minute register wheel, the harder it will be for the minute register wheel to turn. Thus, it will take more force for the flyback lever to return the minute register wheel to a zero position, which may cause the flyback lever to bind on the hearts without sufficient power to return the hearts to zero. This same condition will occur if the minute register wheel, the intermittent wheel, or the seconds wheel is binding.

3. Flyback lever binding, either at the pivoting point, or by scraping on another part that the flyback lever should not contact. This will naturally retard the flyback lever, reducing the force with which it will move towards the hearts.
4. Not oiling the frictional points on the flyback lever, causing it to bind.

If the above conditions have been checked and found to be satisfactory, and the flyback lever still does not have sufficient force to return the hearts to a zero position, the correction would be to bend the flyback lever spring so that it holds a stronger tension on the flyback lever. This will increase the force with which the flyback lever moves towards the hearts, and usually corrects the condition.

For information on the bending of springs, turn to page 105.

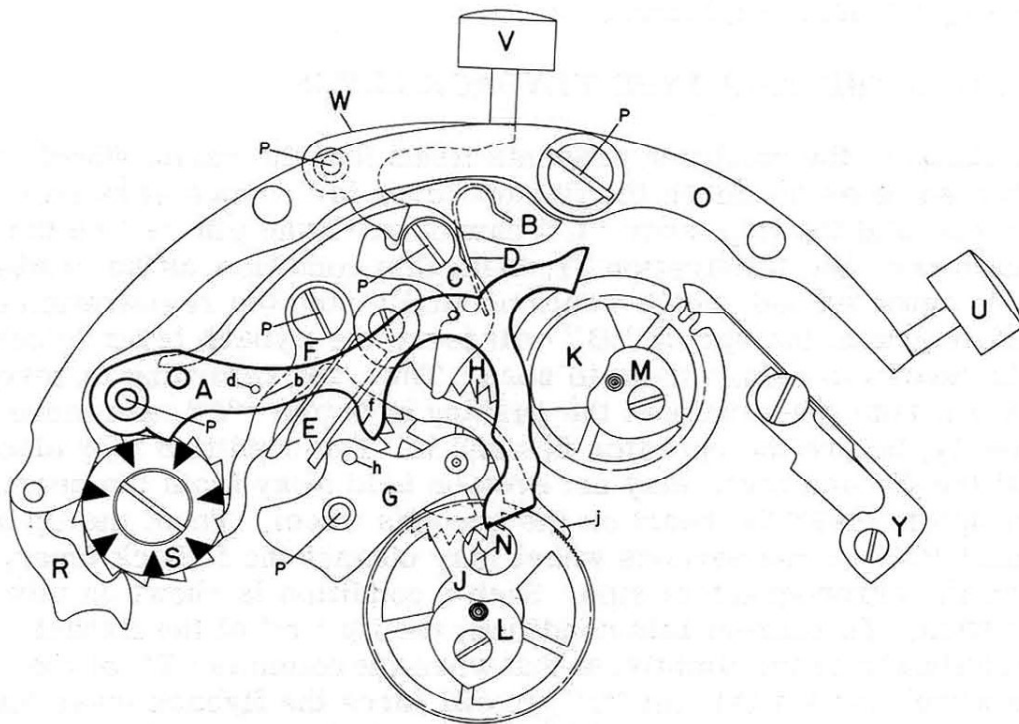

Illustration 29

- |   |   |
|---|---|
| A - Flyback lever                             | L - Seconds wheel heart                 |
| B - Flyback lever spring                      | M - Minute register wheel heart         |
| C - Flyback trip lever                        | N - Dart tooth                          |
| D - Flyback trip lever spring                 | O - Chronograph pivoted detent          |
| E - Brake lever and intermittent lever spring | P - Pivoting point of all parts         |
| F - Brake lever                               | R - Joint hook                          |
| G - Intermittent lever                        | S - Castle wheel                        |
| H - Intermittent wheel                        | U - Chronograph push button             |
| J - Seconds wheel                             | V - Chronograph push button             |
| K - Minute register wheel                     | W - Push piece for setting back to zero |
|   | Y - Minute register pawl                |

## THE PROPER METHOD OF CHECKING THE FUNCTION OF THE TRIP TYPE FLYBACK LEVER

When checking the flyback lever to see that it returns the seconds wheel and the minute register wheel to a zero position, turn the seconds wheel to a position so that the sweep second hand is on about the 30th second of registration. Turn the minute register wheel to relatively the same position. See Illustration 30. Then push the button "V" to release the flyback lever. Then see if the flyback lever returns the seconds wheel and minute register wheel to a zero position. To make this test effectively, it is imperative that the seconds wheel and the minute register wheel are turned to such a position, that to return the wheels to a zero position, the wheels must make one-half revolution. Thus, if the wheels return to zero when in this position, they will return to zero much easier from almost any other position. Naturally, if the seconds wheel and the minute register wheel fail to return to a zero position when making this test, the correction will be made as previously explained.

## REPAIRING THE TRIP TYPE FLYBACK LEVER

Occasionally, the condition presents itself that the castle wheel, as it is turned, does not force the flyback lever far enough away from the hearts, and the trip lever "C" cannot catch the pin "e" on the flyback lever. See Illustration 31. With this condition, as the castle wheel is again turned, which would normally stop the registration of the chronograph, the spring "B" will force the flyback lever to contact the hearts to return them to zero. Thus, the returning to zero action will take place without the pushing of button "V", and more than likely, before the operator desires it. The condition may also be that the flyback lever may not even be held away from the hearts far enough to clear the heart on the seconds wheel. Thus, the tip of the heart "L" on the seconds wheel may contact the flyback lever, causing the chronograph to stop. Such a condition is shown in this Illustration. To correct this condition, the lip "r" of the flyback lever can be stretched slightly, so that when the columns "T" of the castle wheel contact this lip "r", it will force the flyback lever further away from the hearts on the seconds wheel and minute register wheel, making it possible for the trip lever "C" to catch the pin "e" on the flyback lever.

- |   |                                 |
|---|---------------------------------|
| A - Flyback lever                       | L - Seconds wheel heart         |
| B - Flyback lever spring                | P - Pivoting point of all parts |
| C - Flyback trip lever                  | S - Castle wheel                |
| J - Seconds wheel                       | T - Castle wheel columns        |
| K - Minute register wheel               | V - Chronograph push button     |
| W - Push piece for setting back to zero |                                 |

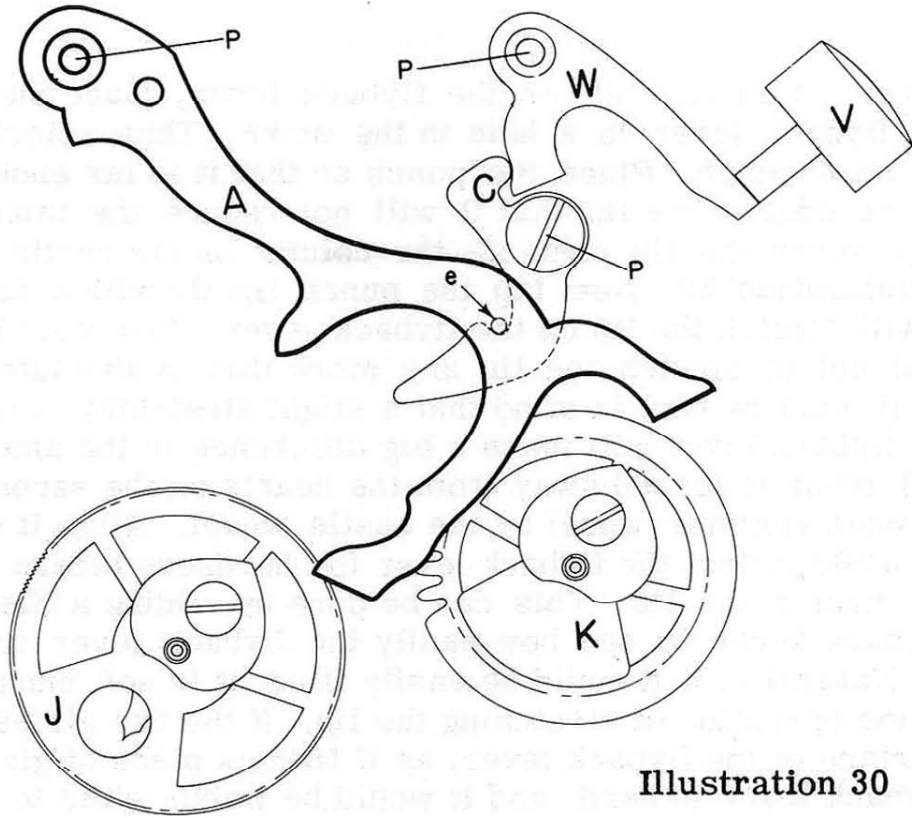

Illustration 30

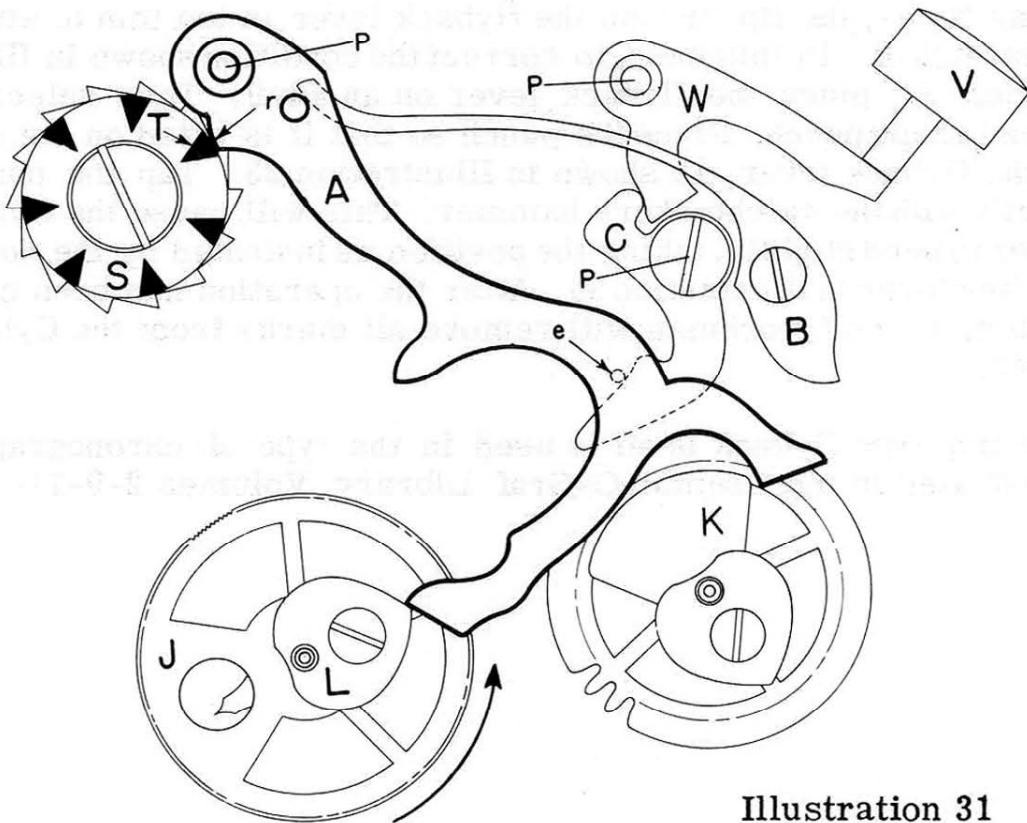

Illustration 31



To stretch this lip "r" on the flyback lever, place the bushing of the flyback lever in a hole in the stake. Then select a small round nose punch. Place the punch so that it is far enough away from the edge of the lip that it will not reduce the thickness of the lip where the lip contacts the column on the castle wheel. See Illustration 32. Now tap the punch lightly with a hammer. This will stretch the lip on the flyback lever. You must be very careful not to stretch the lip any more than is absolutely necessary. It must be kept in mind that a slight stretching of the lip "r" on the flyback lever will make a big difference in the amount the flyback lever is forced away from the hearts on the seconds wheel and minute register wheel by the castle wheel. Also, it would be worth while to test the flyback lever for hardness before attempting to stretch the lip. This can be done by sliding a file across the flyback lever to see how easily the flyback lever could be filed. Naturally, if it could be easily filed, it is soft enough to begin the operation of stretching the lip. If the file glides over the surface of the flyback lever, as if filing a piece of glass, then the flyback lever is hard, and it would be worth while to temper it before attempting this operation.

Many times, the lip "r" on the flyback lever is too thin to attempt to stretch it. In this case, to correct the condition shown in Illustration 31, place the flyback lever on an anvil. Then select a chisel shape punch. Place the punch so that it is tilted on the edge of the flyback lever, as shown in Illustration 33. Tap the punch lightly with the watchmakers hammer. This will cause the flyback lever to bend slightly, taking the position as indicated by the dotted flyback lever in Illustration 34. After the operation has been completed, a good workman will remove all marks from the flyback lever.

The trip type flyback lever is used in the type of chronograph illustrated in the Esembl-O-Graf Library, Volumes 2-9-11-14.

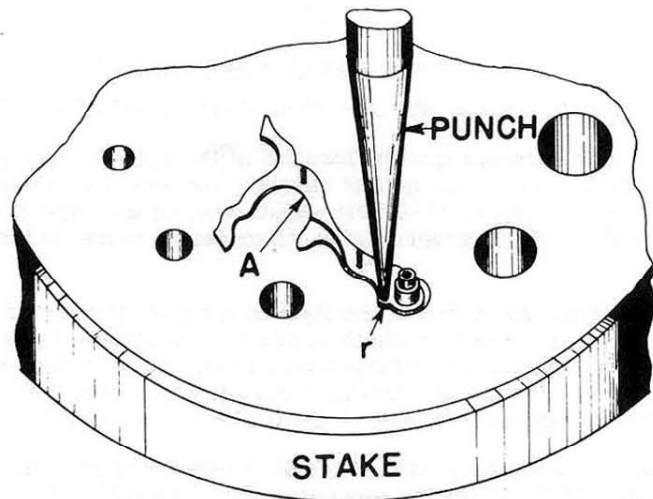

Illustration 32

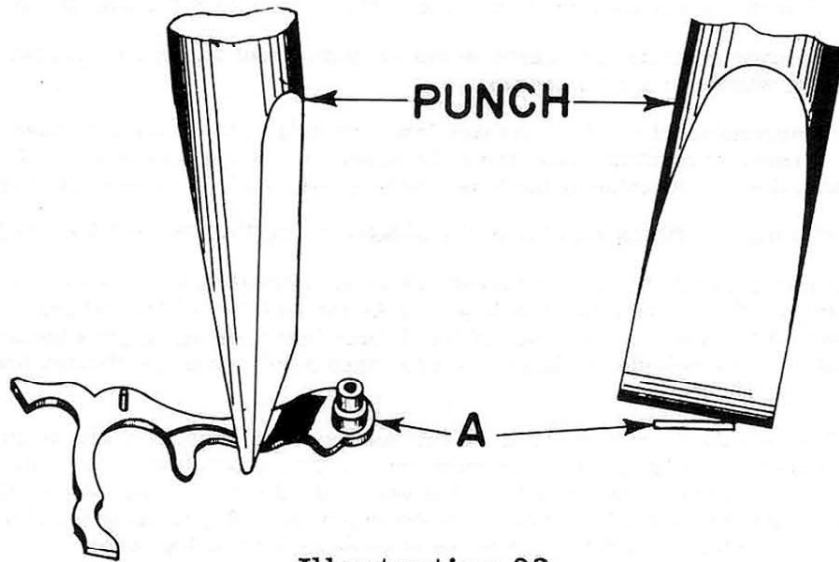

Illustration 33

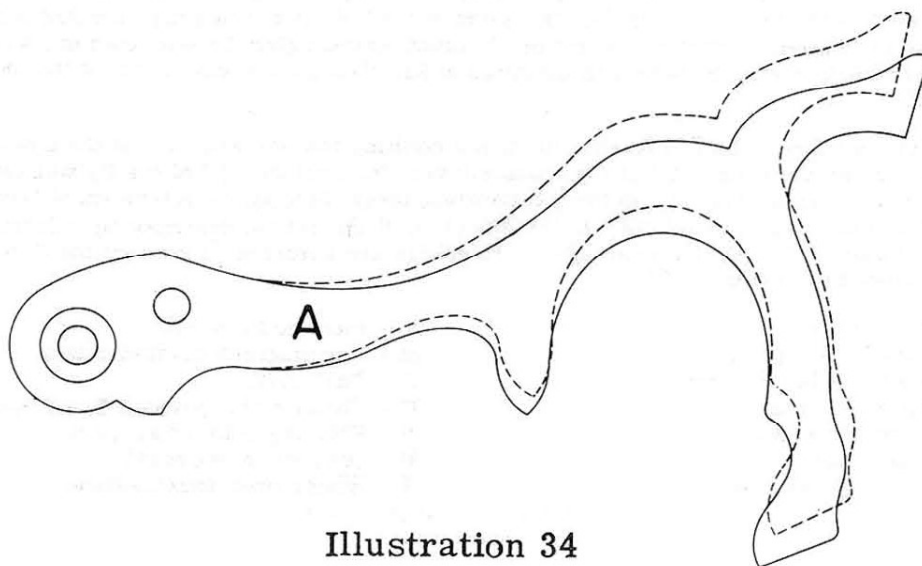

Illustration 34

## PART 4

### NON-CASTLE WHEEL CHRONOGRAPH

#### FUNCTION OF THE FLYBACK LEVER IN A NON-CASTLE WHEEL TYPE CHRONOGRAPH

In a non-castle wheel type chronograph, the function of the flyback lever is quite different from the function of the flyback lever in the type of chronograph with a castle wheel. Although a castle wheel is employed in most types of chronographs, making this type of chronograph very popular, the non-castle wheel chronograph, due to its moderate price, is also a popular chronograph.

In the non-castle wheel type chronograph, the flyback lever must not only perform the returning to zero function, but also a function which in other chronographs is performed by the castle wheel. Since there are only a few arrangements of non-castle wheel chronographs, we can by merely studying the function of one particular model, get a general knowledge of the function of almost all other arrangements of non-castle wheel chronographs.

In the non-castle wheel type chronograph, the flyback lever performs three functions. These functions are performed in the following sequence. See Illustration 35.

1. The flyback lever disengages the intermediary wheel "L" from the seconds wheel "J".
2. The flyback lever disengages the intermittent wheel "H" from the path of the dart tooth "N".
3. The flyback lever contacts the hearts on the seconds wheel and minute register wheel, returning these wheels to a zero position.

To follow the complete function of the flyback lever as listed above, we will start with the flyback lever in a negative position, away from the hearts on the seconds wheel and minute register wheel, and follow the function of the lever step-by-step as it is moved towards the hearts.

#### FUNCTION OF THE FLYBACK LEVER AS IT IS MOVED TOWARDS THE HEARTS

In this type of chronograph, the flyback lever has three notches in it, shown as "b", "c", and "d" in Illustration 35. In these three notches works the end "e" of the flyback lever spring. This spring working in the three notches of the flyback lever, makes it possible for the flyback lever to be set at three definite positions. These three positions of the flyback lever are shown in Illustrations 35, 36, and 37.

Illustration 35 shows the flyback lever in its furthest position away from the hearts, and the end "e" of the flyback lever spring is in notch "b" of the flyback lever. With the flyback lever in this position, the intermediary wheel "L" is engaged with the seconds wheel "J". Thus, the power that is derived from the wheel-over-fourth-wheel "S", is being transmitted to the seconds wheel "J", and the registration of the chronograph is taking place.

Now as the flyback lever is turned to such a position that the end "e" of the flyback lever spring can enter notch "c" of the flyback lever, the stud "f" on the flyback lever will move in the direction of the arrow and contact the surface "h" of the chronograph pivoted detent. This forces the chronograph pivoted detent "M" to pivot, disengaging the intermediary wheel "L" from the seconds wheel, as shown in Illustration 36. Thus, the registration of the chronograph is stopped.

As the flyback lever is turned further to such a position that the end "e" of the flyback lever spring can enter the notch "d" of the flyback lever, the surface "j" of the flyback lever will contact the eccentric stud "k" on the intermittent lever, forcing the intermittent lever to pivot, moving the intermittent wheel "H" in the direction of the arrow, disengaging it from the path of the dart tooth "N". At the same time, the hearts are returned to zero by the flyback lever. This is shown in Illustration 37.

- |                                 |                                       |
|---------------------------------|---------------------------------------|
| A - Flyback lever               | L - Intermediary wheel                |
| B - Flyback lever spring        | M - Chronograph pivoted detent        |
| E - Intermittent lever spring   | N - Dart tooth                        |
| G - Intermittent lever          | O - Chronograph pivoted detent spring |
| H - Intermittent wheel          | P - Pivoting point of all parts       |
| J - Seconds wheel               | R - Seconds wheel heart               |
| K - Minute register wheel       | S - Wheel-over-fourth-wheel           |
| T - Minute register wheel heart |                                       |

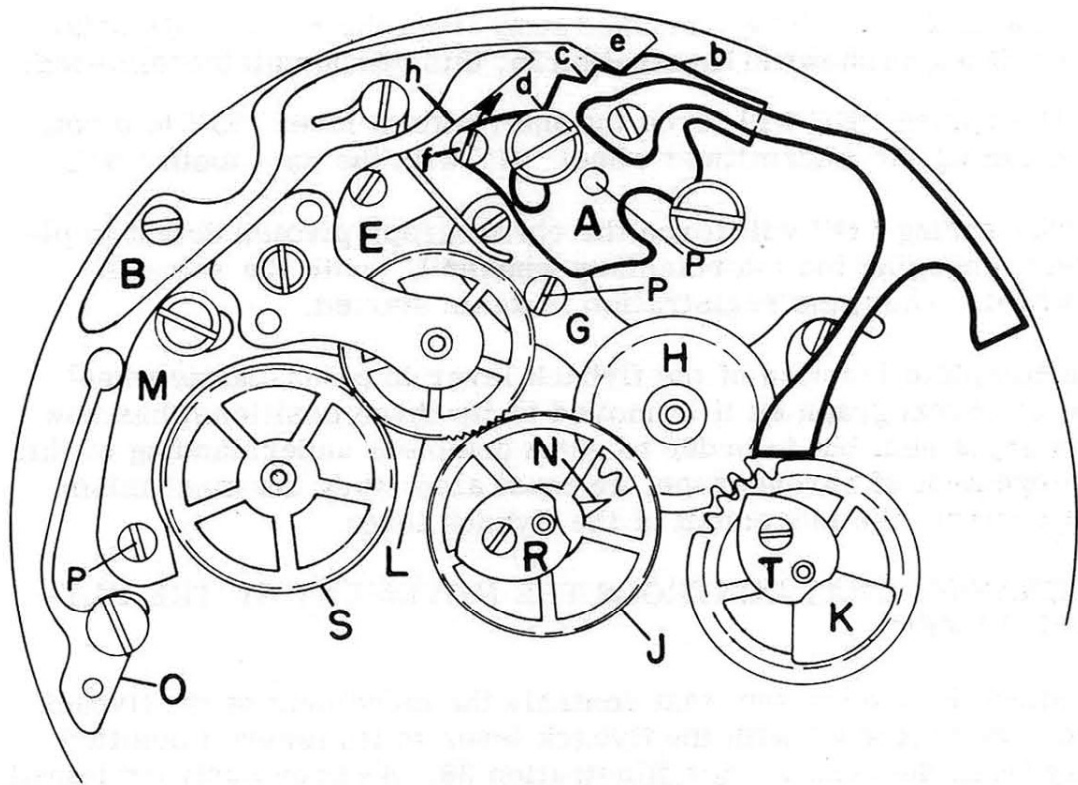

Illustration 35

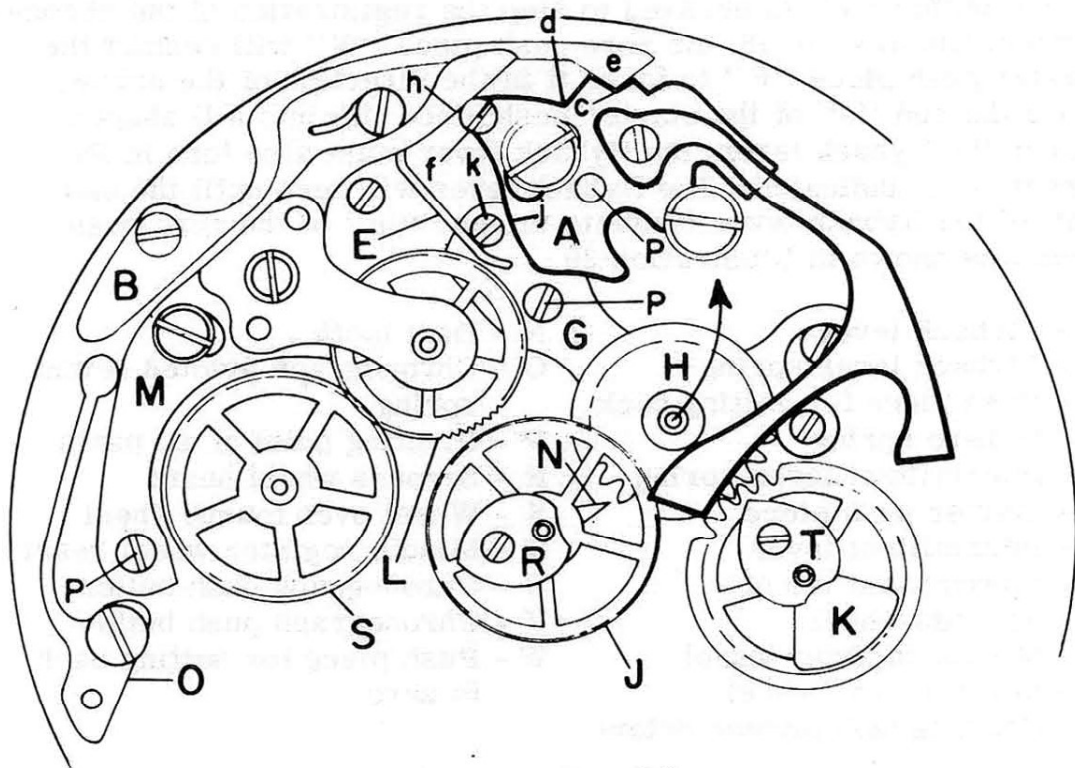

Illustration 36



Now as the flyback lever is turned away from the hearts to its original position, as shown in Illustration 35, this will permit the following:

1. The spring "E" will force the intermittent lever "G" to pivot, engaging the intermittent wheel "H" with the dart tooth "N".
2. The spring "O" will force the chronograph pivoted detent to pivot, engaging the intermediary wheel "L" with the seconds wheel. Thus, the registration is again started.

The complete function of the flyback lever in a non-castle wheel type of chronograph as it is moved to its three positions, has now been explained; but in order to get a complete understanding of this arrangement of chronograph, we must also study the mechanism that controls the movement of the flyback lever.

#### MECHANISM THAT CONTROLS THE MOVEMENT OF THE FLYBACK LEVER

To study the mechanism that controls the movement of the flyback lever, we will start with the flyback lever in its furthest position away from the hearts. See Illustration 38. As previously explained, with the flyback lever in this position, the chronograph is registering.

As the button "V" is pressed to stop the registration of the chronograph, Illustration 38, the zero push piece "W" will contact the starter push piece "F" to force it in the direction of the arrow. Since the end "s" of the starter push piece fits into a U shaped slot in the flyback lever, the flyback lever must also turn in the direction as indicated. The flyback lever will turn until the end "n" of the flyback lever contacts the end "m" of the zero push piece, as shown in Illustration 39.

- |  |   |
|--|---|
| A - Flyback lever                              | N - Dart tooth                          |
| B - Flyback lever spring                       | O - Chronograph pivoted detent spring   |
| D - Push piece for setting back to zero spring | P - Pivoting point of all parts         |
| E - Intermittent lever spring                  | R - Seconds wheel heart                 |
| F - Starter push piece                         | S - Wheel over fourth wheel             |
| G - Intermittent lever                         | T - Minute register wheel heart         |
| H - Intermittent wheel                         | U - Chronograph push button             |
| J - Seconds wheel                              | V - Chronograph push button             |
| K - Minute register wheel                      | W - Push piece for setting back to zero |
| L - Intermediary wheel                         |   |
| M - Chronograph pivoted detent                 |   |

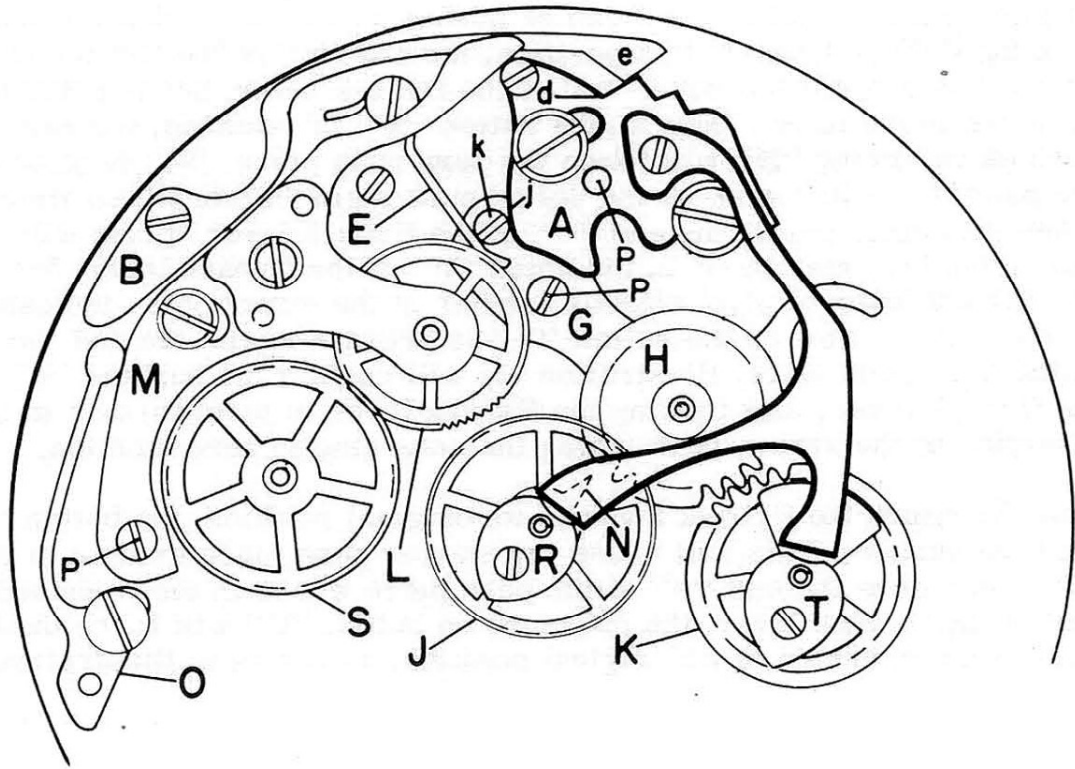

Illustration 37

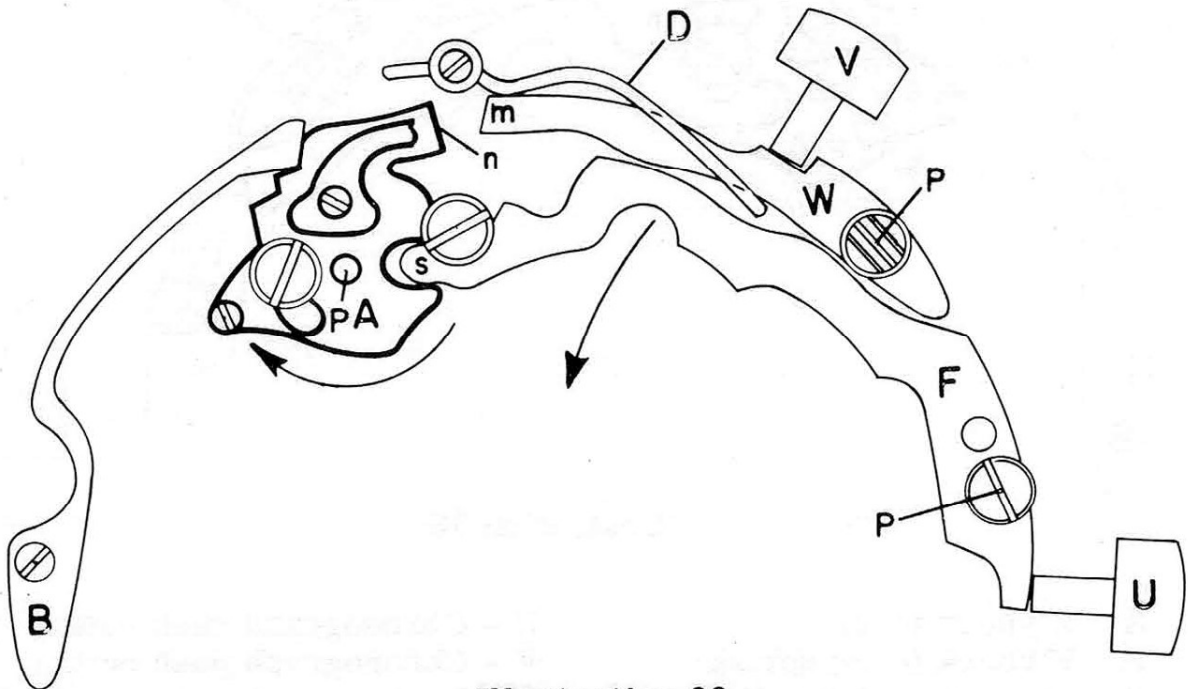

Illustration 38

At this point, the button "V" can be pushed no further. Observe that with the flyback lever in this position, the end "e" of the flyback lever spring has entered the notch "c" of the flyback lever, but is not yet centered in the notch. Now as the button "V" is released, the zero push piece spring "D" will force the zero push piece "W" to pivot to the position as indicated by the dotted push piece in this Illustration. When this takes place, the end "e" of the flyback lever spring will immediately center itself in the notch "c" of the flyback lever, forcing the flyback lever to pivot slightly further in the direction as indicated by the arrow. Now as the button "V" is pressed again, the end "m" of the zero push piece, Illustration 40, will contact the surface "p" of the flyback lever, thus forcing the flyback lever to pivot further in the direction of the arrow, performing the returning to zero function.

Now, to return the flyback lever to its original position, the button "U" must be pushed. This will cause the starter push piece to pivot at point "P", and since the end "s" of the push piece works in the U shaped slot of the flyback lever, the pressure on button "U" will force the flyback lever to return to its original position, as shown in Illustration 38.

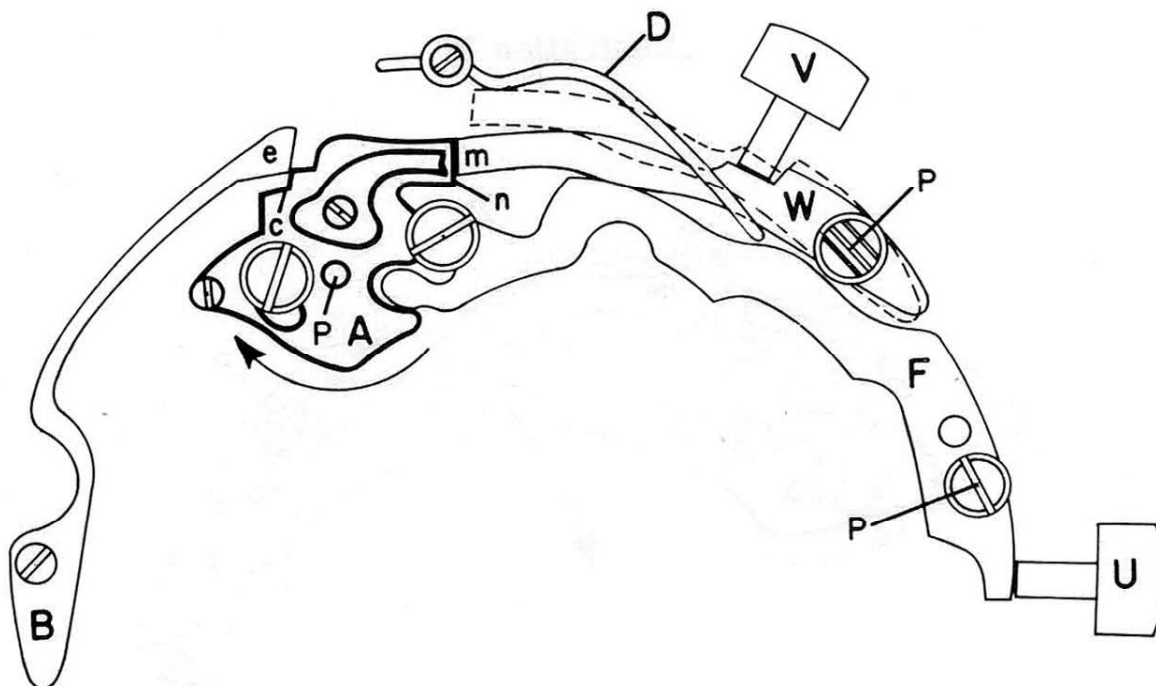

Illustration 39

- |  |   |
|--|---|
| A - Flyback lever                              | U - Chronograph push button             |
| B - Flyback lever spring                       | V - Chronograph push button             |
| D - Push piece for setting back to zero spring | W - Push piece for setting back to zero |
| F - Starter push piece                         |   |

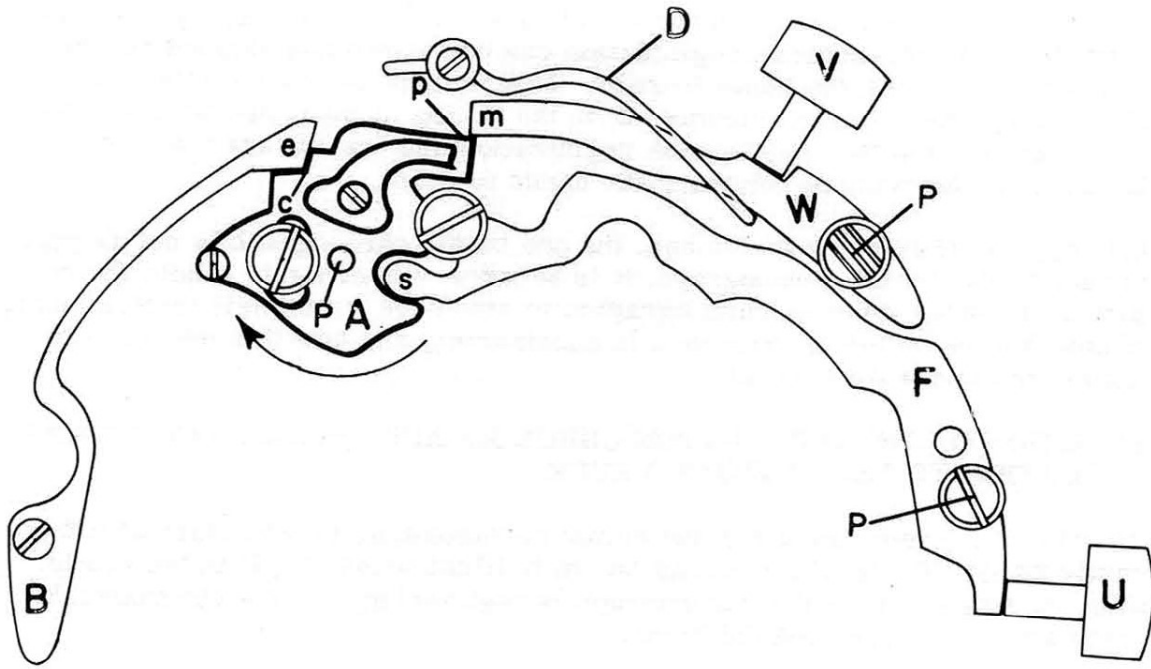

Illustration 40

## PART 5

### ONE BUTTON CHRONOGRAPH

It may be thought that it would be better to start out this book with the function of the one button chronograph, but we felt that since the one button chronograph is not as popular as the two button chronograph, it would be better to explain primarily in this book, the function and repair of the two button chronograph, and only by comparison, point out the peculiarities of the one button chronograph.

Although there are many arrangements and constructions of chronograph mechanisms, nearly every chronograph performs three basic functions. These are:

1. Starting of the chronograph registration.
2. Stopping of the chronograph registration.
3. Returning to zero of the chronograph hands.

In a one button chronograph, all three of the above functions are controlled by one button. The first time the button is pushed, the registration begins. On the second push of the button, the registration is stopped, and on the third push of the button, the hands are returned to zero.

The fact that the one button chronograph must always go through this sequence of operations is of a great disadvantage, and is the reason for the need of the two button chronograph. In the two button chronograph, only the starting and stopping of the registration is controlled by one button, while the other button controls the returning to zero of the chronograph hands. Since in the two but-



ton chronograph, one button controls only the starting and stopping of the registration, the chronograph registration can be started and stopped repeatedly without returning the hands to zero. This feature makes a two button chronograph much more valuable, as in the timing of many operations, it is necessary to stop the chronograph registration and start it again to continue the registration without returning the hands to zero.

Although, as previously mentioned, the one button chronograph is not as popular as the two button chronograph, it is necessary in order to handle the repair of the many types of chronographs, to also have a complete understanding of how the one button chronograph is constructed, and how this mechanism should function when correct.

#### FUNCTION OF THE ONE BUTTON CHRONOGRAPH, PAYING PARTICULAR ATTENTION TO THE FLYBACK LEVER

To explain the function of the one button chronograph, we will start with the castle wheel "R" in a position as shown in Illustration 41. With the castle wheel in this position, the chronograph is registering, and the chronograph parts are in the following positions:

1. The intermediary wheel "L" is engaged with the seconds wheel "J". With these wheels engaged, the power is being delivered from the wheel-over-fourth wheel "S", to the seconds wheel.
2. The intermittent wheel "H" is in a position so that the dart tooth "N" can engage with it.
3. The brake lever "F" is held disengaged from the seconds wheel "J".

Now, as the button "V" is pushed to turn the castle wheel one ratchet tooth in a clockwise direction, the castle wheel will take the position as shown in Illustration 42, and the results are as follows:

1. The column "c" of the castle wheel contacted the end "b" of the chronograph pivoted detent and forced the detent to pivot, disengaging the intermediary wheel "L" from the seconds wheel "J".
2. The spring "D" forced the end "d" of the brake lever to enter the space between the columns of the castle wheel, engaging end "h" of the brake lever with the seconds wheel. Thus, the registration of the chronograph is stopped, as shown in this Illustration.

When the button "V" is again pushed to turn the castle wheel one ratchet tooth

A - Flyback lever  
B - Flyback lever spring  
D - Brake lever spring  
E - Intermittent lever spring  
F - Brake lever  
G - Intermittent lever  
H - Intermittent wheel  
J - Seconds wheel  
K - Minute register wheel  
L - Intermediary wheel  
M - Chronograph pivoted detent

N - Dart tooth  
O - Chronograph pivoted detent spring  
P - Pivoting point of all parts  
R - Castle wheel  
S - Wheel over fourth wheel  
T - Actuating detent lever spring  
U - Actuating detent lever  
V - Chronograph push button  
W - Joint hook  
Y - Seconds wheel heart  
Z - Minute register wheel heart

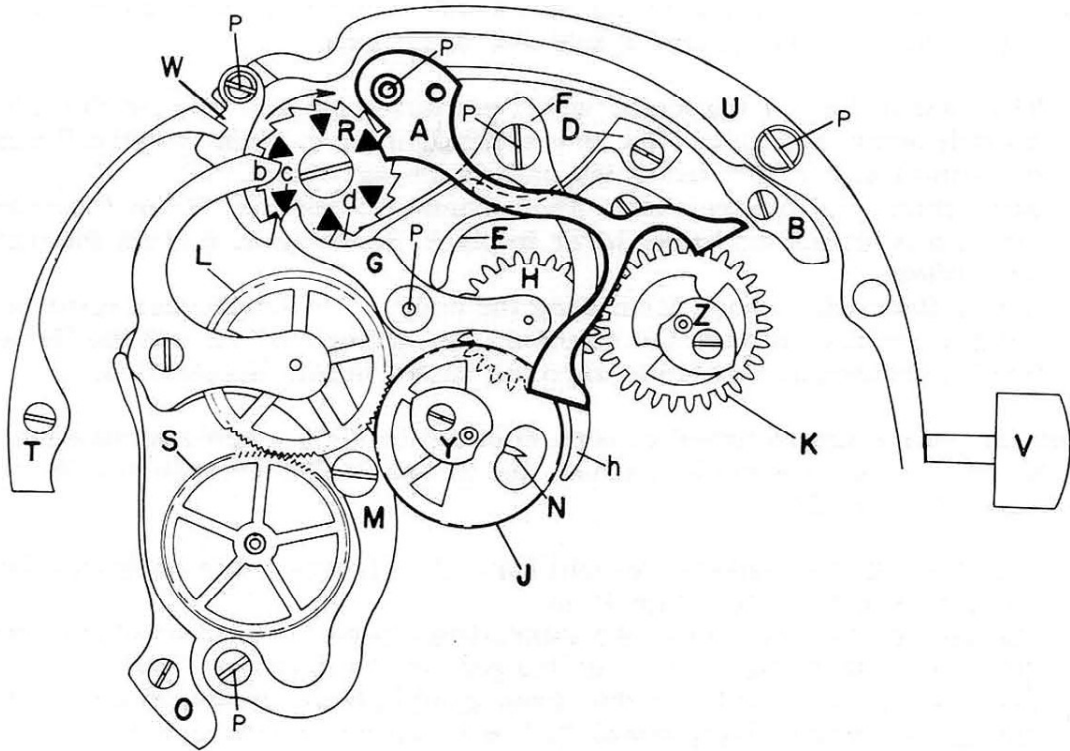

Illustration 41

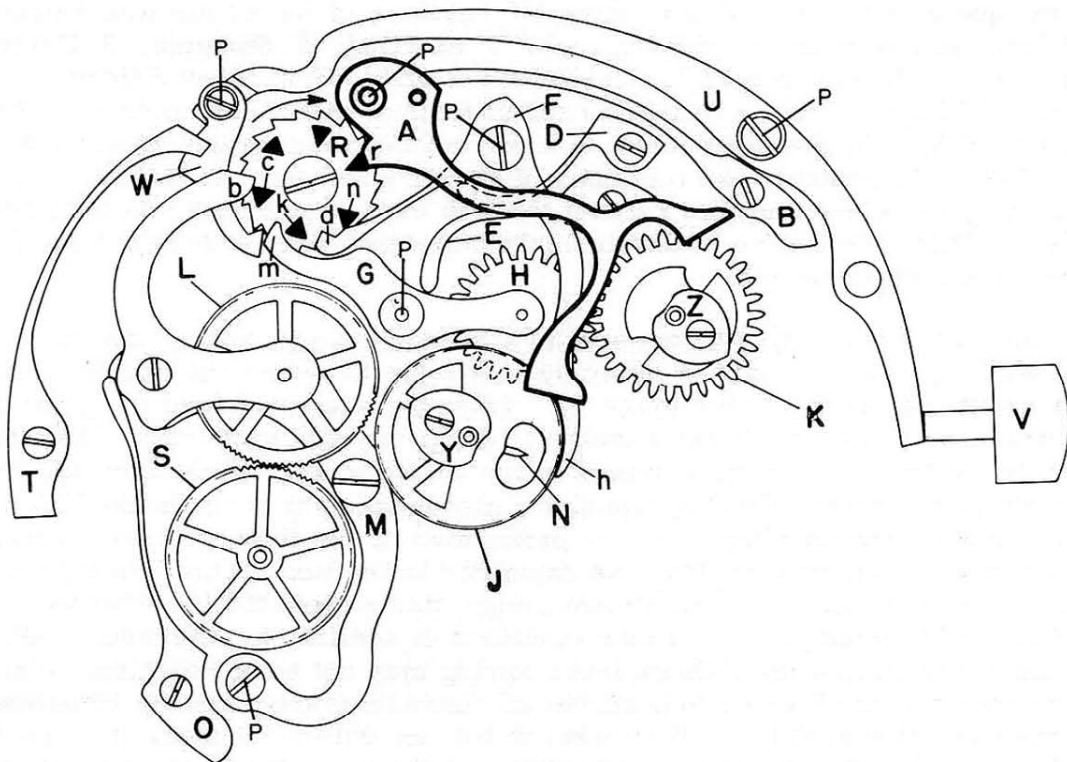

Illustration 42

in a clockwise direction, the castle wheel will take the position as shown in Illustration 43, and the results of this are as follows:

1. The column "k" of the castle wheel contacted the end "m" of the intermittent lever, and forced the intermittent lever to pivot, moving the intermittent wheel "H" out of the path of the dart tooth "N".
2. The column "n" on the castle wheel contacted the end "d" of the brake lever, and forced the brake lever to pivot, disengaging it from the seconds wheel.
3. Due to the castle wheel permitting the end "r" of the flyback lever to enter the space between the columns, the spring "B" forced the flyback lever to return the hearts to zero, as shown in this Illustration.

After the hearts are returned to zero in order to start a new registration, the button "V" must again be pushed, and as the castle wheel turns, the results are as follows:

1. A column of the castle wheel will force the flyback lever back away from the hearts to its original position.
2. The spring "E" will force the intermittent lever "G" to pivot, moving the intermittent wheel "H" into the path of the dart tooth "N".
3. The spring "O" will force the chronograph pivoted detent to pivot, engaging the intermediary wheel "L" with the seconds wheel "J".

Thus, the chronograph parts return to their original positions, as shown in Illustration 41.

In the one button chronograph, since the columns of the castle wheel control all three functions of the chronograph, 1. Starting, 2. Stopping, 3. Returning to zero, the columns of the castle wheel must set at three different positions. Thus, there must be three ratchet teeth to every one column on the castle wheel. On the other hand, in a two button chronograph, where the castle wheel only controls two functions of the chronograph, 1. Starting, 2. Stopping, there are only two ratchet teeth to every one column on the castle wheel. This information is particularly important when ordering a castle wheel for a chronograph.

Another point that might be brought to attention here is that in the one button chronograph, the flyback lever when moving to return the hearts to zero, did not disengage the brake lever "F" from the seconds wheel "J", nor did it disengage the intermittent wheel "H" from the dart tooth "N". This function was performed by the columns of the castle wheel, Illustration 43. In nearly all two button chronographs, the disengagement of the brake lever "F" and the intermittent wheel "H", is performed by the flyback lever. This, in many cases, is a disadvantage, as explained in the text on the trip type flyback lever, pages 25 and 26. This disadvantage stems from the fact that when the flyback lever must perform other functions in addition to returning to zero of the chronograph, the flyback lever spring may not have sufficient strength to force the flyback lever to perform all these functions, and the returning to zero is not completed. Of course, in the one button chronograph, since the flyback lever only performs one function, there is generally no trouble in the function of this mechanism.

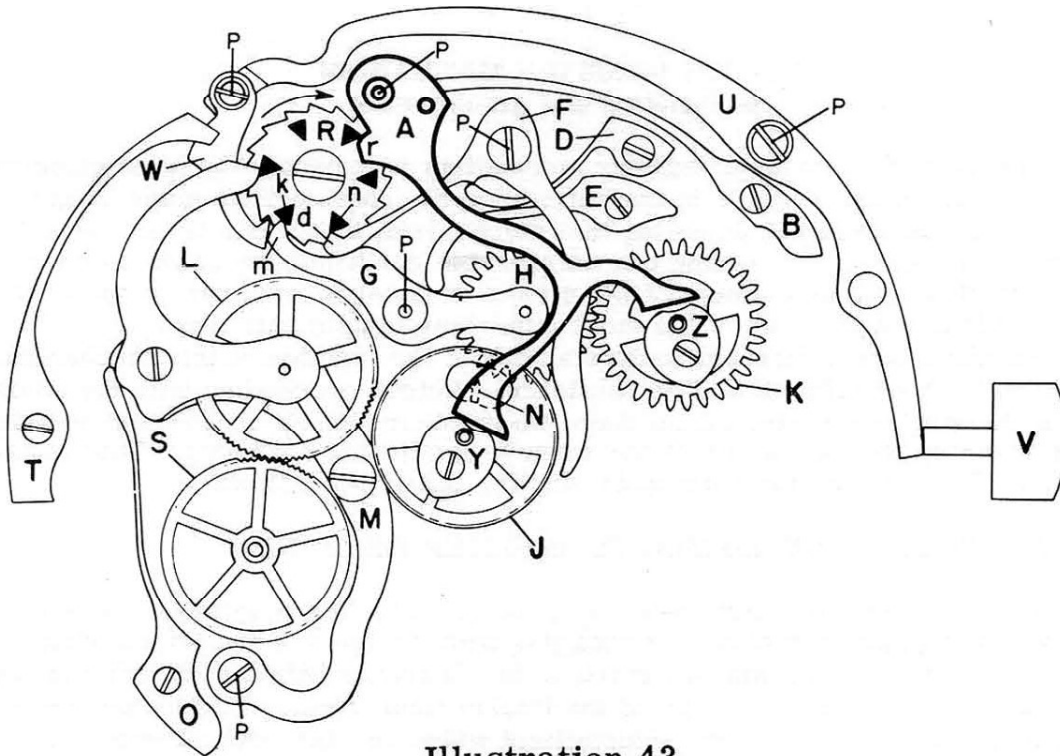

Illustration 43

### EFFECT OF MAGNETISM IN A CHRONOGRAPH

If the seconds wheel heart turns instead of remaining at a zero position when the flyback lever is forced in the direction away from the heart, it may be that the condition causing the movement of the heart from a zero position is magnetism in the flyback lever or the heart.

When there is magnetism in the flyback lever or the heart, the flyback lever as it is forced in the direction away from the heart, will have a tendency to pull the heart. Thus, the heart may turn in order that the edge of the heart can stay in contact with the flyback lever.

The turning of the heart in a clockwise or counter-clockwise direction, due to magnetism, may cause a displacement of the sweep second hand on the dial from 1/5 second or less to 20 seconds.

Many times, oil on the flyback lever or hearts, if it has become thick and gummy, can have a similar effect. This is one of the main reasons we do not recommend the oiling of the flyback lever or the hearts.

If oil is applied to the flyback lever or the hearts, it should be applied very sparingly, and a very thin oil should be used. This will reduce to a minimum the chances of the oil becoming thick and gummy.

Magnetism in the watch movement itself will generally give a slow rate, but in very small wrist watches, the effect may be the reverse, and the rate fast.



## PART 6

### MINUTE REGISTER MECHANISM Its Function and Adjustments

The adjustment of the minute register mechanism is probably the most complex adjustment that must be made in the chronograph. There are so many things that must be considered in adjusting this mechanism, that if one is not careful, sometimes by merely correcting one unfavorable condition, we cause another to appear. Since the adjustment of the minute register mechanism is one of the most complex, and also one of the most important adjustments that must be made, we must have a thorough understanding of the function of this mechanism, along with each adjustment and its limitation. Before proceeding with the adjustment of the minute register mechanism, we must first of all understand how the minute register mechanism functions when it is adjusted correctly. This is explained in the text for Illustrations 44, 45, 46, and 47, as follows.

#### THE PROPERLY ADJUSTED MINUTE REGISTER MECHANISM

Illustration 44 shows the dart tooth "E", which turns in a counter-clockwise direction, at a position just before engaging with the teeth of the intermittent wheel "M". Observe in this Illustration, the clearance between the point of the dart tooth "E" and the tooth "A" of the intermittent wheel. This clearance is shown with the tooth "F" of the intermittent wheel resting against tooth "G" of the minute register wheel. The reason for having the tooth "F" resting against tooth "G", is because with the intermittent wheel in this position, the clearance between the dart tooth "E" and the tooth "A" of the intermittent wheel will be the least that could exist in the normal functioning of the minute register mechanism. Thus, with the intermittent wheel in this position, if we have clearance between the dart tooth "E" and the tooth "A" of the intermittent wheel, we can be assured that at no time could the dart tooth "E" contact the tooth "A" of the intermittent wheel. It can also be seen in Illustration 44, by observing the dotted dart tooth, that with the intermittent wheel in this position, with the tooth "F" resting against tooth "G", the clearance between the dart tooth and the tooth "C" of the intermittent wheel would be the same as between the dart tooth and the tooth "A" of the intermittent wheel. The fact that the clearance of the dart tooth between teeth "A" and "C" is the same, indicates that the tooth "B" of the intermittent wheel is centered on the imaginary line "T", which is drawn from the center of the intermittent wheel to the center of the seconds wheel.

In Illustration 45, the dart tooth has progressed in a counter-clockwise direction, from the position shown in Illustration 44, and has contacted the tooth "B" of the intermittent wheel. Observe in Illustration 45 that the tooth "B" of the intermittent wheel is still centered on the imaginary line "T", which is drawn from the center of the seconds wheel to the center of the intermittent wheel. Illustration 46 shows the dart tooth has traveled further in a counter-clockwise direction, and has turned the intermittent wheel, thus causing the minute register wheel to turn. The amount the minute register wheel has turned, can be seen by how far the tooth of the minute register wheel has slid up the inclined plane on the end "H" of the minute register pawl.

E - Dart tooth  
M - Intermittent wheel  
N - Eccentric stud

O - Minute register pawl  
P - Minute register wheel  
Q - Seconds wheel

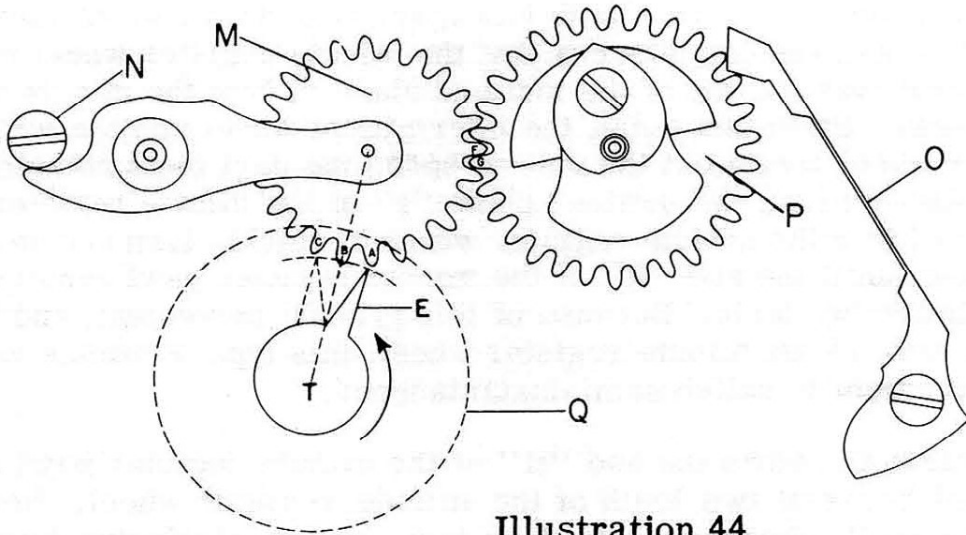

Illustration 44

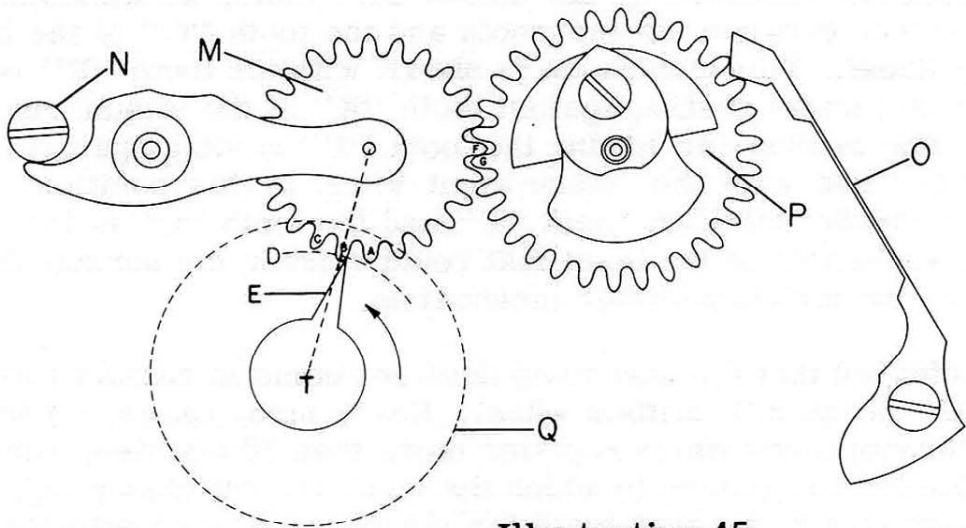

Illustration 45

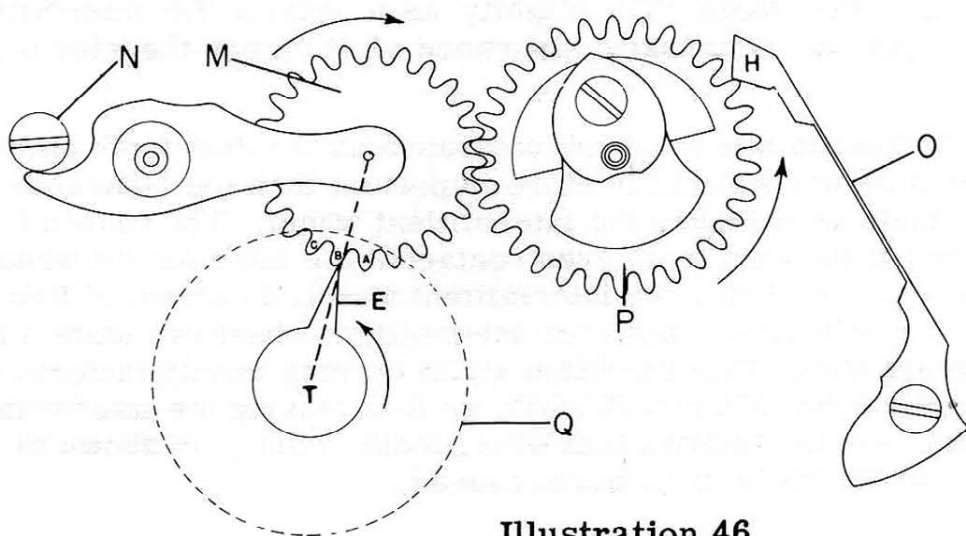

Illustration 46

In Illustration 47, the dart tooth has again moved further counter-clockwise, and you can observe that the minute register wheel tooth has passed over the top of the inclined plane "J" of the minute register pawl. Up to this point, the intermittent wheel and the minute register wheel rotated at the rate of speed the dart tooth rotated. From this point on, the inclined plane "I" of the minute register pawl will force the minute register wheel to quickly turn counter-clockwise, until the end "H" of the minute register pawl centers itself between two teeth. Because of this gradual movement, and then a quick jump of the minute register wheel, this type of minute register mechanism is called semi-instantaneous.

Illustration 48 shows the end "H" of the minute register pawl again centered between two teeth of the minute register wheel. Now, as the dart tooth progresses further in a counter-clockwise direction to the position indicated by the dotted dart tooth, we must observe the clearance between the dart tooth and the tooth "C" of the intermittent wheel. This clearance is shown with the tooth "F" of the intermittent wheel resting against tooth "K" of the minute register wheel. The reason for having the tooth "F" resting against tooth "K" is because with the intermittent wheel in this position, the clearance between the dart tooth "E" and the tooth "C" of the intermittent wheel will be the least that could exist in the normal functioning of the minute register mechanism.

It is preferred that the dart tooth does not come in contact with the tooth "C" of the intermittent wheel. But in many cases, especially in the chronographs which register more than 30 minutes, such as 45 or 60 minute registers in which the teeth are set closer together, the adjustment of the dart tooth for clearance is very delicate. In the case of this delicate adjustment, it may be necessary to let the dart tooth touch tooth "C" slightly as it leaves the intermittent wheel to get the necessary clearance as it enters the intermittent wheel.

It must be kept in mind that the clearance as the dart tooth enters the intermittent wheel is far more important than the clearance of the dart tooth as it leaves the intermittent wheel. The reason for this is that if the dart tooth ever contacted the intermittent wheel tooth as it was entering the intermittent wheel, as shown in Illustration 49, it would either move the intermittent wheel two teeth, or the watch would stop. This condition would be very unsatisfactory, but on the other hand, if the dart tooth, as it is leaving the intermittent wheel, touches the intermittent wheel tooth slightly as shown in Illustration 50, there is no harm caused.

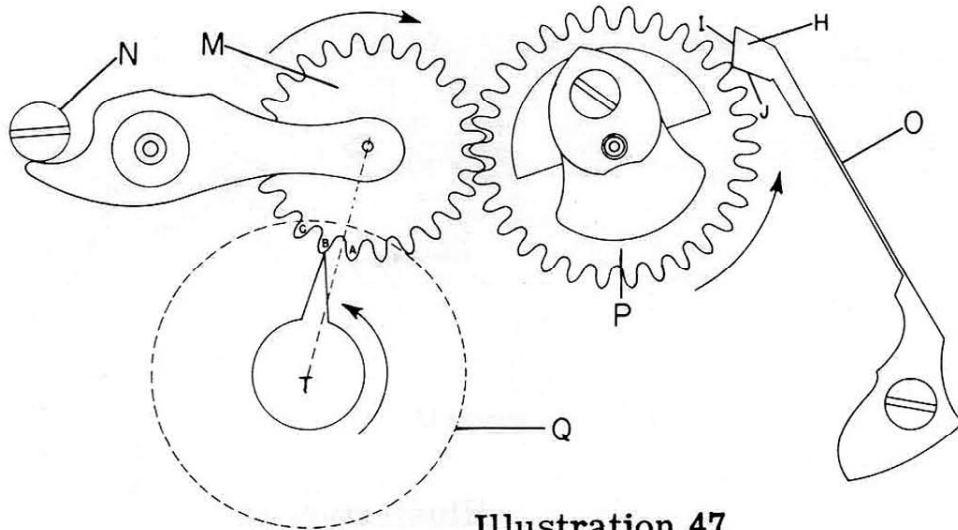

Illustration 47

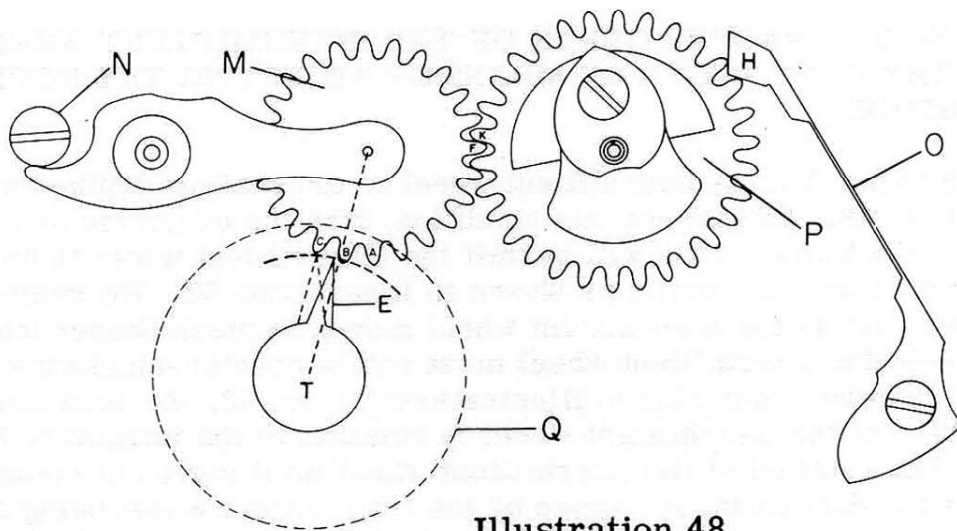

Illustration 48

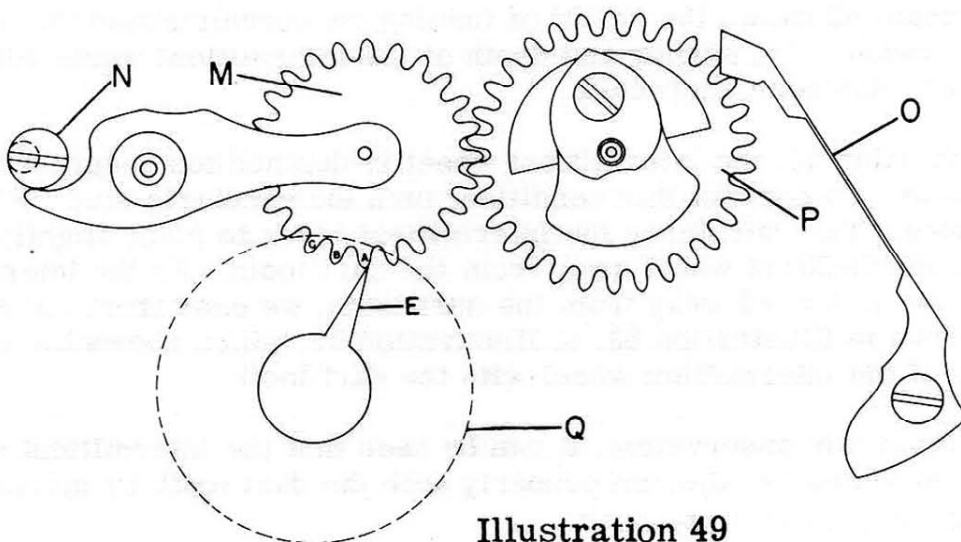

Illustration 49



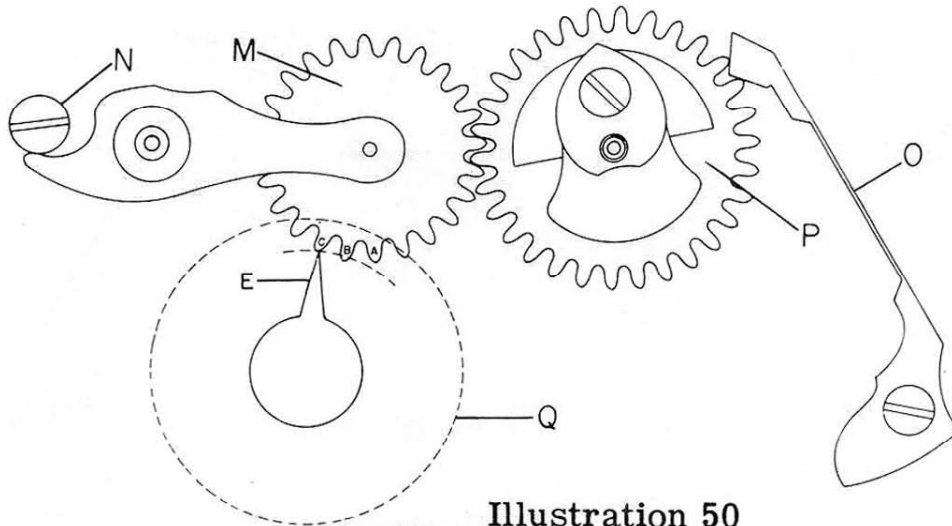

Illustration 50

**SETTING THE PROPER DEPTH OF THE INTERMITTENT WHEEL WITH THE DART TOOTH BY MEANS OF ADJUSTING THE ECCENTRIC STUDS**

In Illustration 51, the intermittent wheel is too shallow depthed with the dart tooth. To correct this condition, turn the eccentric stud "N" counter clockwise. This will permit the intermittent wheel to mesh deeper with the dart tooth, as shown in Illustration 52. We must also consider that as the intermittent wheel moves to mesh deeper with the dart tooth, the intermittent wheel must rotate counter-clockwise. This can be seen by comparing in Illustrations 51 and 52, the location of tooth "B" of the intermittent wheel in relation to the imaginary line "T". The rotation of the intermittent wheel as it moves to mesh deeper with the dart tooth, is caused by the intermittent wheel being engaged with the minute register wheel, which is held stationary at this time.

Illustration 52 shows the result of turning the eccentric stud "N" counter-clockwise. The setting and depth of the intermittent wheel with the dart tooth has been corrected.

In Illustration 53, the intermittent wheel is depthed too deeply with the dart tooth. To correct this condition, turn the eccentric stud "N" clockwise. This will force the intermittent lever to pivot slightly, forcing the intermittent wheel away from the dart tooth. As the intermittent wheel is forced away from the dart tooth, we pass from the condition shown in Illustration 53, to Illustration 52, which shows the correct setting of the intermittent wheel with the dart tooth.

Thus, from this observation, it can be seen that the intermittent wheel can many times be adjusted properly with the dart tooth by merely adjusting the eccentric stud "N".

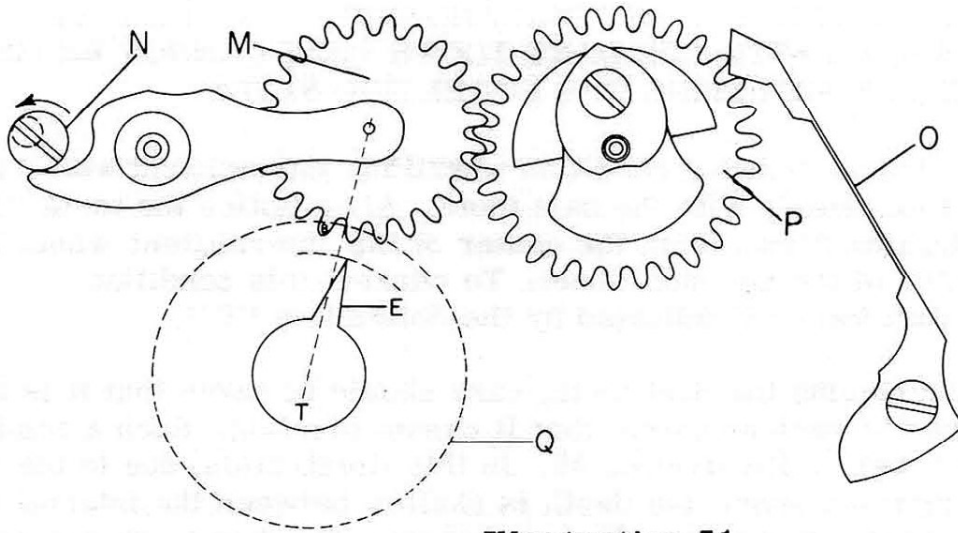

**Illustration 51**

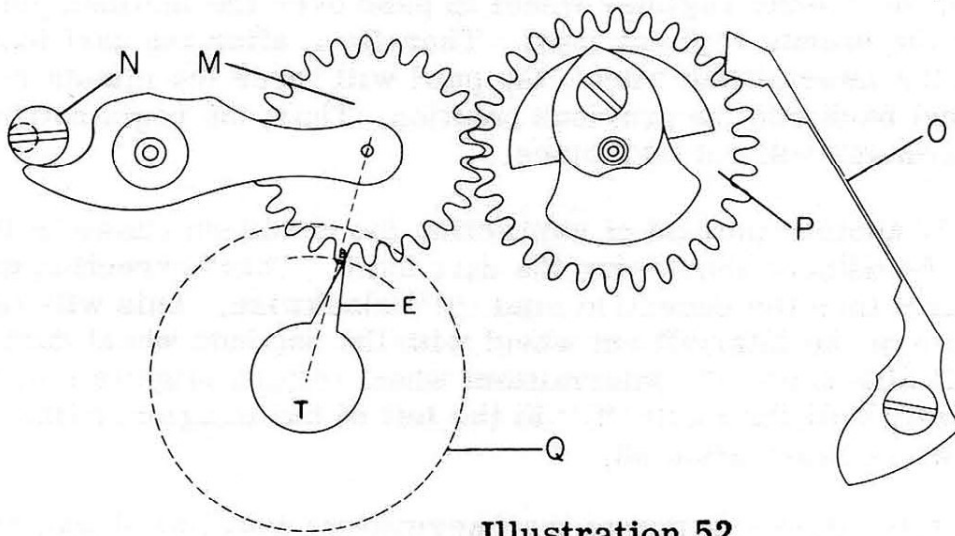

**Illustration 52**

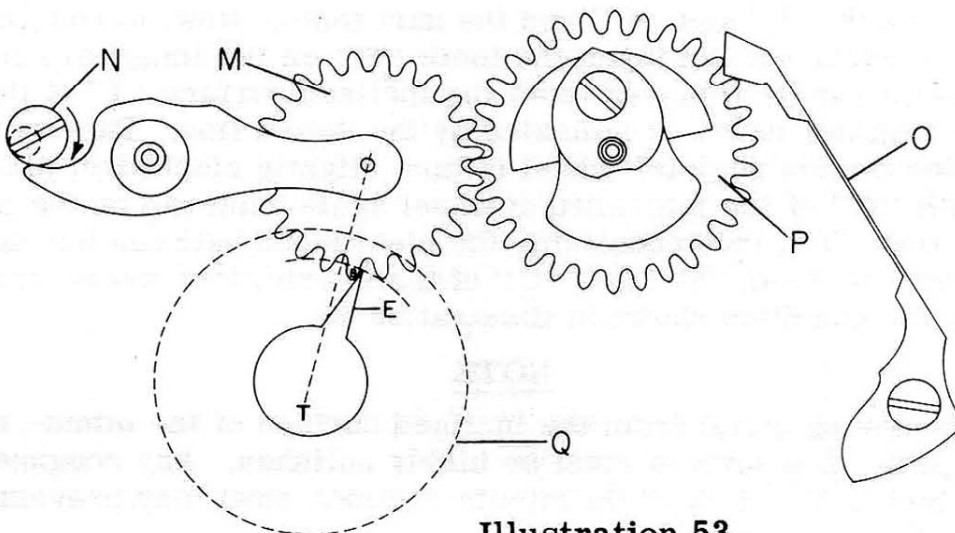

**Illustration 53**

## CORRECTIONS IN THE SETTING AND DEPTH OF THE INTERMITTENT WHEEL WITH THE DART TOOTH THAT CANNOT BE MADE BY MERELY ADJUSTING THE ECCENTRIC STUDS

Illustration 54 shows a condition where the intermittent wheel is meshed too deeply with the dart tooth. Also, notice the tooth "B" is on the line drawn from the center of the intermittent wheel to the center of the seconds wheel. To correct this condition, shorten the dart tooth as indicated by the dotted line "D".

When shortening the dart tooth, care should be taken that it is not shortened to such an extent that it cannot function. Such a condition is shown in Illustration 55. In this Illustration, due to the dart tooth being too short, the depth is shallow between the intermittent wheel and the dart tooth. Because of this, the dart tooth cannot force the intermittent wheel to turn far enough to cause the tooth "L" on the minute register wheel to pass over the inclined plane "J" of the minute register pawl. Therefore, after the dart tooth leaves the intermittent wheel, the pawl will force the minute register wheel back into the previous position. Thus, the registration of the minutes will not take place.

There is another method of correcting the condition shown in Illustration 54 without shortening the dart tooth. This correction would be to first turn the eccentric stud "N" clockwise. This will reduce the depth of the intermittent wheel with the seconds wheel dart tooth, and will also cause the intermittent wheel to turn slightly clockwise, which will shift the tooth "B" to the left of the imaginary line "T", as shown in Illustration 56.

Due to this slight rotation of the intermittent wheel as it was shifted away from the dart tooth, we did not maintain an equal clearance between teeth "A" and "C" and the dart tooth. Now, to equalize the two clearances and bring the tooth "B" on the imaginary line "T," metal can be removed from the inclined surface "I" of the minute register pawl, as indicated by the dotted line. This will cause the minute register wheel to turn slightly clockwise, placing the tooth "B" of the intermittent wheel again centered on the imaginary line "T", thus equalizing the clearances between the dart tooth and the teeth "A" and "C" of the intermittent wheel, correcting the condition shown in Illustration 54.

### NOTE

After removing metal from the inclined surface of the minute register pawl, this surface must be highly polished. Any roughness on the inclined surface of the minute register pawl may prevent it from performing its function.

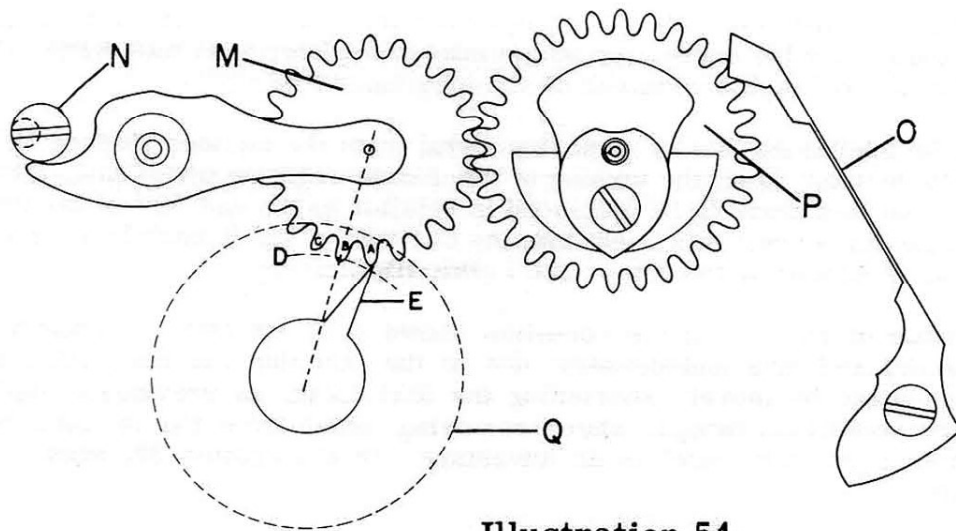

Illustration 54

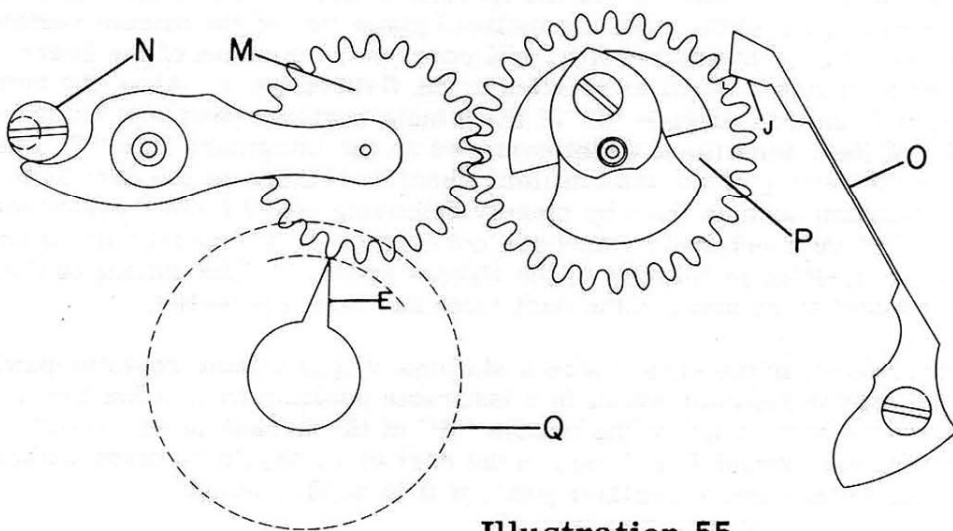

Illustration 55

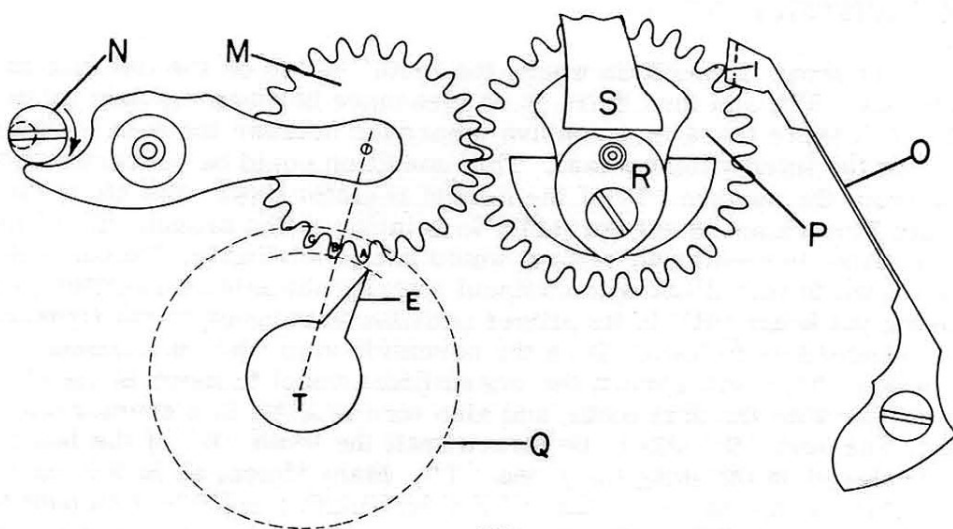

Illustration 56



Illustration 57 shows the correct setting of the intermittent wheel in relation to the dart tooth after the correction on the minute register pawl was made. Observe that the tooth "B" is now centered on the imaginary line "T".

It should be mentioned that by removing metal from the inclined surface "I" of the minute register pawl, the turning of the minute register wheel caused the heart "R" on this wheel to be displaced in relation to the end "S" of the flyback lever. Thus, to correct this condition, the end "S" of the flyback lever must be changed as indicated by the dotted line in this Illustration.

This method of correcting the condition shown in Illustration 54 would be very troublesome, and thus unnecessary due to the fact that the correction could have been made by merely shortening the dart tooth, as previously explained. There are conditions though, where removing metal from the inclined surface of the minute register pawl is an advantage. In Illustration 58, such a condition exists.

Observe in Illustration 58, the position of the heart "R" on the minute register wheel in relation to the end "S" of the flyback lever. This condition indicates that the removing of metal from the inclined plane "I" of the minute register pawl, as indicated by the dotted line, will correct the position of the heart "R" on the minute register wheel in relation to the flyback lever. Also, the removing of metal from this surface "I" of the minute register pawl will bring the tooth "B" of the intermittent wheel centered on the imaginary line "T", thus correcting the setting of the intermittent wheel in relation to the dart tooth. Under a condition such as this, by merely removing metal from the inclined surface "I" of the pawl, two errors are corrected. 1. The heart "R" is brought to its proper position in relation to the flyback lever. 2. The setting of the intermittent wheel in relation to the dart tooth has been corrected.

On the other hand, in the case where a stationary type minute register pawl is holding the minute register wheel in a favorable position so that the heart "R" is correctly set in relation to the branch "S" of the flyback lever, a correction of the intermittent wheel in relation to the dart tooth should be made without the changing of the minute register pawl, if it is at all possible.

#### METHOD OF CORRECTING THE SETTING OF THE INTERMITTENT WHEEL IN RELATION TO THE DART TOOTH WITHOUT THE CHANGING OF THE MINUTE REGISTER PAWL

Illustration 59 shows a condition where the tooth "B" is on the left side of the imaginary line "T", and thus there is no clearance between the dart tooth and the tooth "A", while there is excessive clearance between the dart tooth and tooth "C" of the intermittent wheel. This condition could be corrected by removing metal from the surface "I" of the minute register pawl. But since the heart "R" in this Illustration is set correctly in relation to the branch "S" of the flyback lever, this, as mentioned before, would not be advisable. To correct the condition shown in this Illustration without altering the minute register pawl, and thus keeping the heart "R" in its proper position in relation to the flyback lever, we should proceed as follows. Turn the eccentric stud "N" in a counter-clockwise direction. This will permit the intermittent wheel to move in the direction to mesh deeper with the dart tooth, and also turn slightly in a counter-clockwise direction. The stud "N" should be turned until the tooth "B" of the intermittent wheel is centered on the imaginary line "T". Many times, as in this case, when the intermittent wheel is moved toward the dart tooth a sufficient amount to place the tooth "B" on the imaginary line "T", the depth of the dart tooth with the

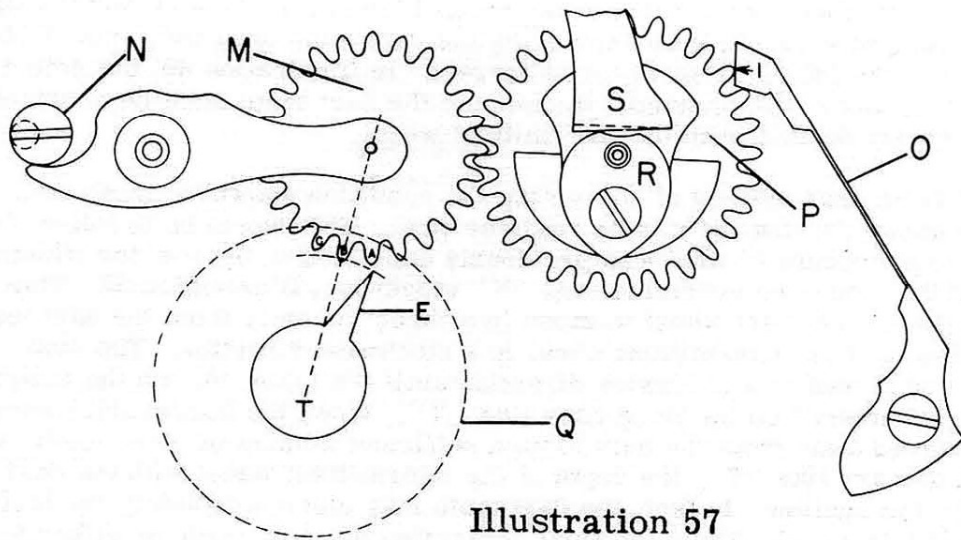

Illustration 57

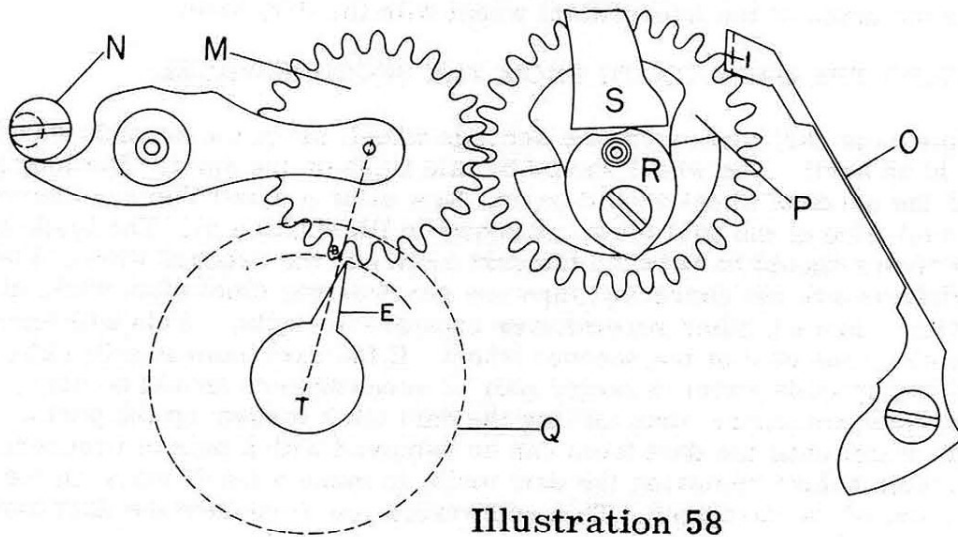

Illustration 58

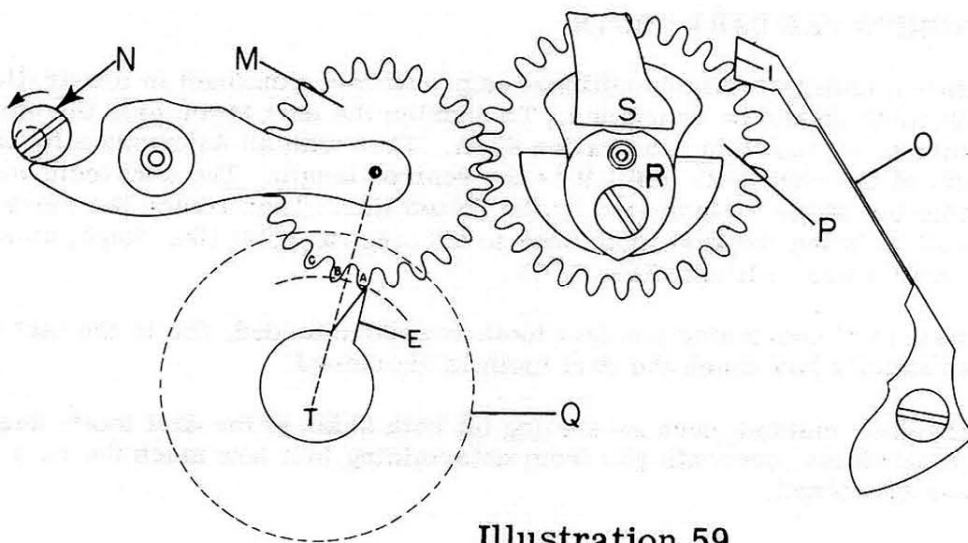

Illustration 59

intermittent wheel is too deep, as shown in Illustration 60, and thus the final correction must be made by shortening the dart tooth until the depth of the dart tooth with the intermittent wheel is correct. In Illustration 60, the dotted line "D" indicates in this instance, the amount the dart tooth must be shortened to be correctly depthed with the intermittent wheel.

There is another method of correcting the condition shown in Illustration 59, also without altering the minute register pawl. This would be to follow the exact reverse procedure of what was previously explained in the text for Illustrations 59 and 60. Turn the eccentric stud "N" clockwise, Illustration 59. This will force the intermittent wheel to move in a direction away from the dart tooth, and will also turn the intermittent wheel in a clockwise direction. The stud "N" should be turned in a clockwise direction until the tooth "A" on the intermittent wheel is centered on the imaginary line "T". When the intermittent wheel has been moved away from the dart tooth a sufficient amount to place tooth "A" on the imaginary line "T", the depth of the intermittent wheel with the dart tooth may be too shallow. In fact, the dart tooth may clear completely the teeth of the intermittent wheel. Thus, the final correction must be made by either lengthening the dart tooth, or replacing the dart tooth with a new one that is longer, correcting the depth of the intermittent wheel with the dart tooth.

#### REMOVING THE DART TOOTH FROM THE SECONDS WHEEL

To remove the dart tooth from the seconds wheel, place the seconds wheel over a hole in an anvil. The wheel should be laid flush on the anvil. The long post "U" of the seconds wheel should be up. Now slide a small thin edge screwdriver under each side of the dart tooth, as shown in Illustration 61. The blade of the screwdrivers should be between the dart tooth and the seconds wheel. When the screwdrivers are set correctly, turn one screwdriver clockwise, while at the same time, turn the other screwdriver counter-clockwise. This will force the dart tooth up the post of the seconds wheel. If the dart tooth is still tight on the post of the seconds wheel, a larger pair of screwdrivers should be used, following the same procedure, thus forcing the dart tooth further up the post of the seconds wheel until the dart tooth can be removed with a pair of tweezers. It is advisable before removing the dart tooth, to make a small mark on the wheel at the point of the dart tooth. This will enable you to replace the dart tooth in the same position.

#### SHORTENING THE DART TOOTH

Sometimes, under certain conditions, as previously explained in Illustration 60, the dart tooth should be shortened. To shorten the dart tooth, grip the dart tooth in a pin vise, as shown in Illustration 62-A. Then with an Arkansas slip, take off the point of the dart tooth until it is the desired length. The dart tooth will then resemble the shape as indicated by the dotted line. Then reface the sides of the dart tooth to bring the dart tooth back to its original point like shape, as shown by the dotted line in Illustration 62-B.

This method of shortening the dart tooth is recommended, due to the fact it can be seen exactly how much the dart tooth is shortened.

Using another method, such as stoning off both sides of the dart tooth, keeping a point at all times, prevents you from determining just how much the dart tooth has been shortened.

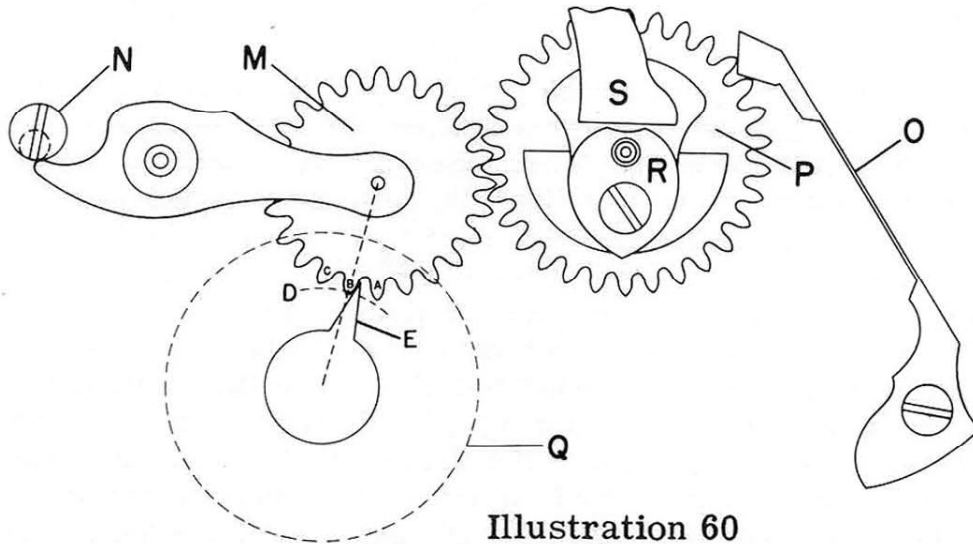

Illustration 60

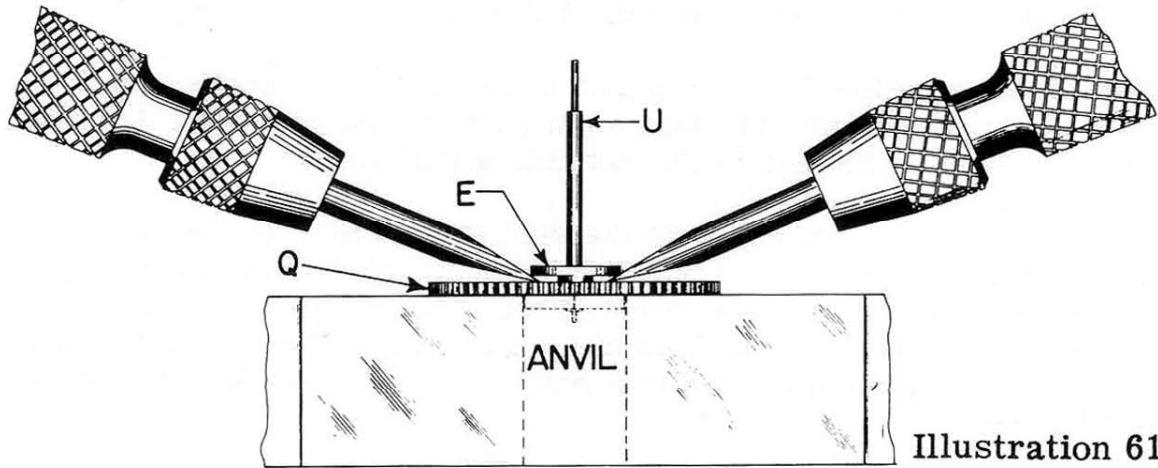

Illustration 61

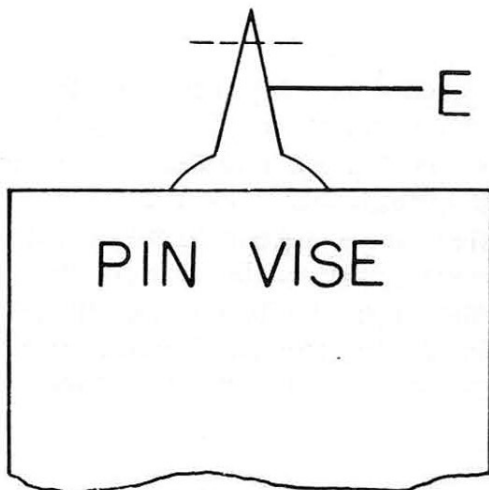

Illustration 62-A

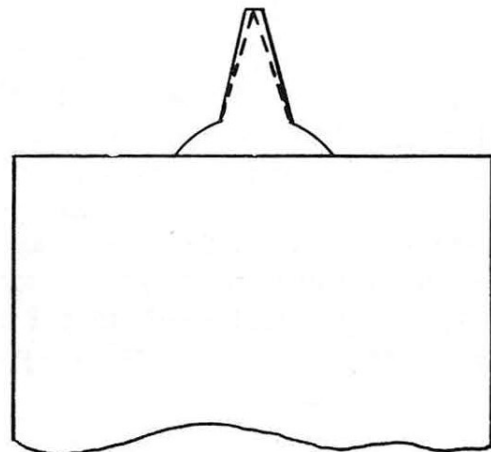

Illustration 62-B

E - Dart Tooth  
 M - Intermittent Wheel  
 N - Eccentric Stud

O - Minute Register Pawl  
 P - Minute Register Wheel  
 Q - Seconds Wheel



## REPLACING THE DART TOOTH ON THE SECONDS WHEEL

To replace the dart tooth on the seconds wheel, place the short top pivot of the seconds wheel over a hollow flat face punch in the stake, as shown in Illustration 63. Then place the dart tooth on the seconds wheel long post "U". Adjust the dart tooth on the seconds wheel post so that the point of the dart tooth is over the small mark that was made on the wheel before the dart tooth was removed. If the repairman neglected to place a small mark on the wheel before removing the dart tooth, the dart tooth must be adjusted on the wheel to its approximate correct position. The final adjustment will have to be done later. The approximate correct position of the dart tooth would be with the point of the dart tooth centered over the oval shaped hole "B" in the seconds wheel. This oval shaped hole "B" in the seconds wheel was made for the purpose of making it possible to see the dart tooth when the wheel is in the chronograph.

Now select a hollow flat face punch to fit over the seconds wheel post "U". Then stake the dart tooth down on the post until the dart tooth is flush on the hub of the seconds wheel staff.

Caution: Before staking down the dart tooth, check to see that the hole in the hollow flat face punch is deep enough to take the long post on the seconds wheel. Otherwise, when staking down the dart tooth, the post may reach the depth of the hole in the hollow flat face punch, and any staking down beyond that point will break the post on the seconds wheel.

## SETTING THE DART TOOTH TO ITS PROPER POSITION ON THE SECONDS WHEEL

When the intermittent wheel has been adjusted to its proper depth and setting with the dart tooth, we must then check the location of the dart tooth on the seconds wheel. The dart tooth should be in such a position on the seconds wheel so that approximately on the 58th second of registration, the minute register hand begins to move forward slowly, and on the 60th second of registration, the minute register hand jumps forward to complete the registration of one minute. If the dart tooth is not set correctly on the seconds wheel, the registration of minutes may occur before or after the 60th second of registration.

In Illustration 64, we show a condition where the dart tooth "F" is not set correctly on the seconds wheel, causing the registration of the minutes to be early. In this Illustration, the seconds wheel is at a zero position, but the dart tooth is in such a position on the seconds wheel that when the registration begins, the seconds wheel will not

make a full revolution before the minute registration is completed. Thus, the minute registration may occur on the 50th second of registration instead of the 60th second. To correct this condition, the dart tooth "F" must be turned on the seconds wheel in a clockwise direction, to a position so that the seconds wheel will make one full revolution from a zero position before the minute registration is completed. In this case, to place the dart tooth in its correct position so that the minute registration will occur exactly on the 60th second of registration, the dart tooth "F" must be moved to the position of the dotted dart tooth.

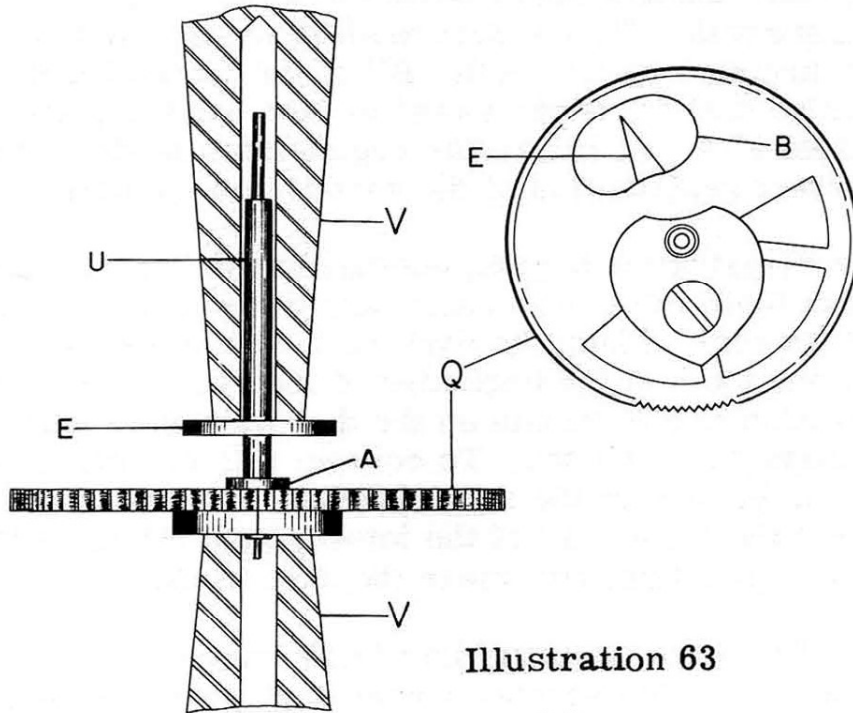

Illustration 63

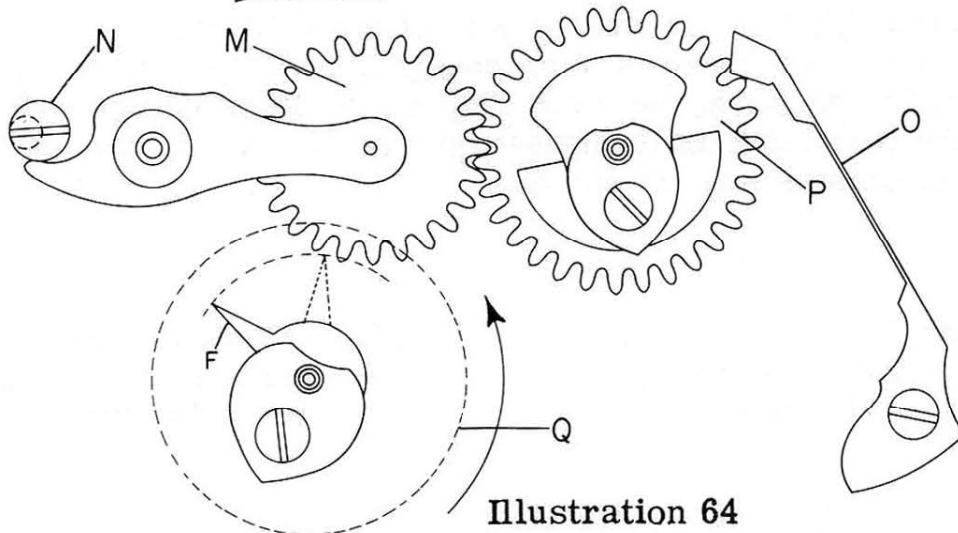

Illustration 64

- A - Hub of seconds wheel staff
- F - Dart tooth
- M - Intermittent wheel
- N - Eccentric stud

- O - Minute register pawl
- P - Minute register wheel
- Q - Seconds wheel
- V - Hollow flat face punch

Many times, because of a slight incorrect setting of the dart tooth, a condition as shown in Illustration 65 occurs. In this Illustration, we show the seconds wheel at a zero position, and the intermittent wheel at a position just before it has fully engaged with the dart tooth. Due to the dart tooth "E" being at an incorrect position on the seconds wheel, the tooth "B" of the intermittent wheel has contacted the dart tooth.

Now as the intermittent wheel moves to a fully engaged position as shown in Illustration 66, the dart tooth is forced slightly in a clockwise direction by the tooth "B" of the intermittent wheel. This condition will cause the sweep second hand to jump slightly counter-clockwise just before the registration begins, resulting in an incorrect registration of the seconds on the dial.

Now as the registration begins, another error occurs, due to the fact the dart tooth is on the wrong side of the tooth "B" of the intermittent wheel. Thus, the dart tooth will move the intermittent wheel one tooth at the beginning of the registration, causing the registration of one minute on the dial when only a few seconds of registration have elapsed. To correct this condition, move the dart tooth on the post of the seconds wheel slightly counter-clockwise, so that the tooth "B" of the intermittent wheel as it moves to an engaging position, will clear the dart tooth.

Illustration 67 shows the dart tooth in its correct position on the seconds wheel, and the seconds wheel is at a zero position. The dotted line "D" shows the path of the tooth "B" of the intermittent wheel as it moves to an engaging position. With the dart tooth in this position, the tooth "B" of the intermittent wheel will clear the dart tooth as it engages, preventing any error such as shown in Illustrations 65 and 66.

E - Dart tooth  
M - Intermittent wheel  
N - Eccentric stud

O - Minute register pawl  
P - Minute register wheel  
Q - Seconds wheel

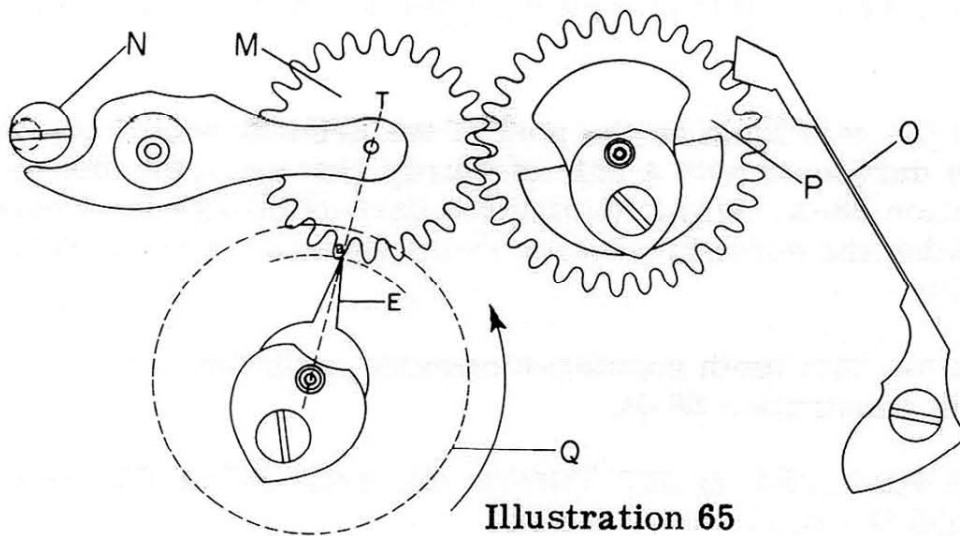

Illustration 65

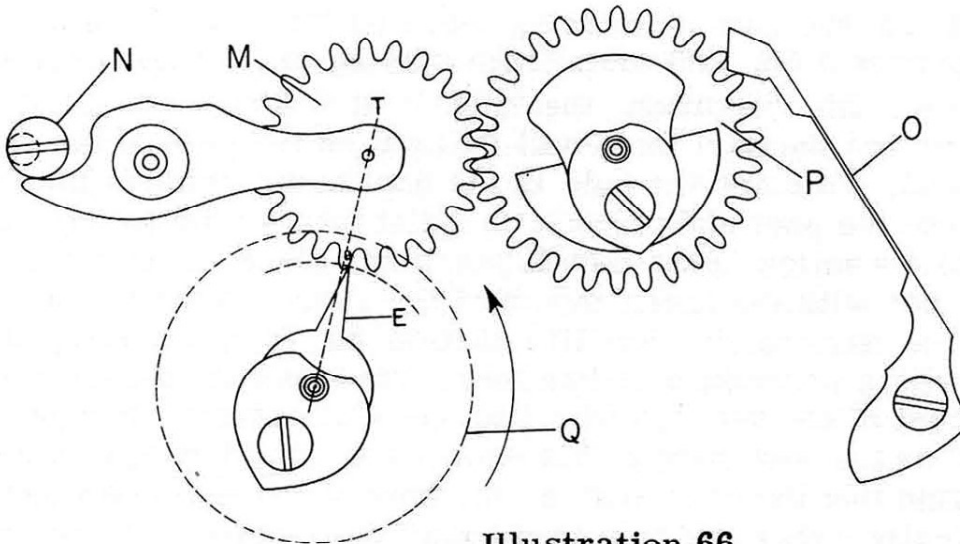

Illustration 66

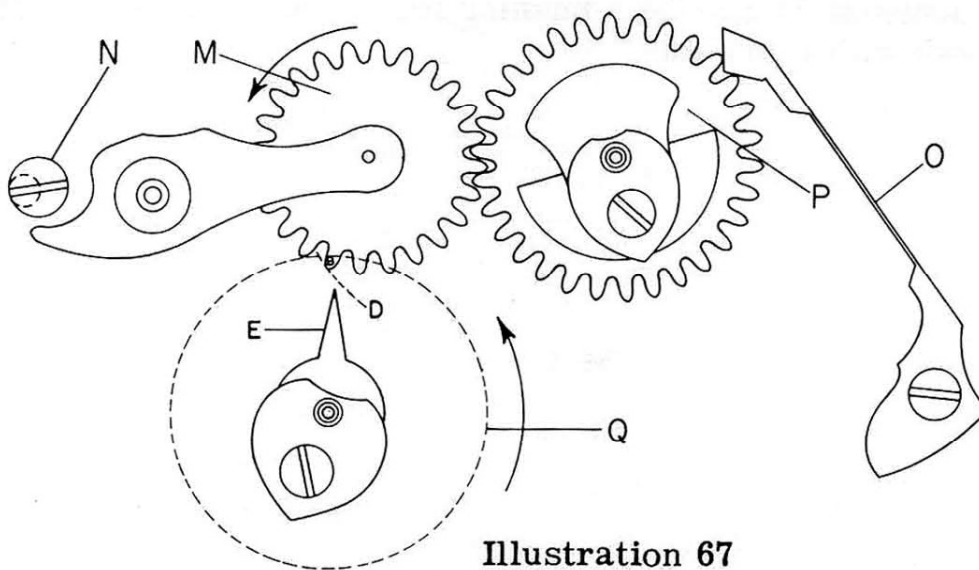

Illustration 67



## TURNING THE DART TOOTH ON THE POST OF THE SECONDS WHEEL

To turn the dart tooth on the post of the seconds wheel clockwise, grip the dart tooth with a pair of sturdy tweezers, as shown in Illustration 68-A. While holding the dart tooth with the tweezers, and holding the seconds wheel with the fingers, turn the dart tooth clockwise.

To turn the dart tooth counter-clockwise, grip the dart tooth as shown in Illustration 68-B.

## TIGHTENING THE DART TOOTH ON THE POST OF THE SECONDS WHEEL

Many times, the dart tooth being loose on the post of the seconds wheel prevents the dart tooth from staying in its correct position. To correct this condition, the hole in the dart tooth must be closed so that the dart tooth will fit tight on the post of the seconds wheel. To close the hole in the dart tooth, remove the dart tooth from the post and place it on a flat face stump in the stake. Now select a hollow taper mouth punch and place the punch in the staking set with the taper mouth of the punch centered over the hole in the dart tooth. See Illustration 69. Now tap the punch lightly with a watchmakers hammer. Then replace the dart tooth on the post of the seconds wheel to see if it is tight. If it is still not tight on the post, repeat this procedure. Of course, this method of tightening the dart tooth on the post of the seconds wheel is only effective when the hole in the dart tooth needs closing only slightly. Any large amount of closing of the hole in the dart tooth would necessitate making a bushing for the hole, or replacing the dart tooth with a new one.

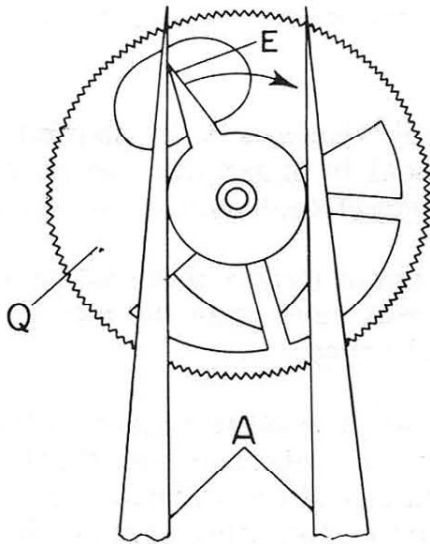

Illustration 68-A

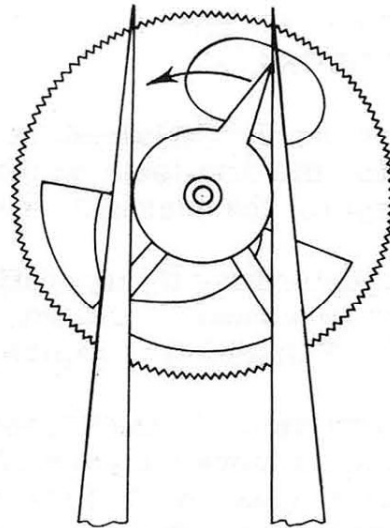

Illustration 68-B

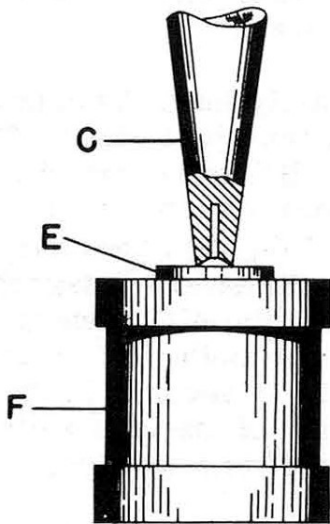

Illustration 69

- A - Tweezers
- C - Hollow taper mouth punch
- E - Dart tooth
- F - Flat face stump
- Q - Seconds wheel

## LENGTH OF THE DART TOOTH AND ITS EFFECT ON THE CHRONOGRAPH

As previously explained, it is sometimes necessary to shorten or lengthen the dart tooth on the seconds wheel in order that the setting and depth of the intermittent wheel with the dart tooth can be corrected.

When performing this operation of changing the length of the dart tooth, it may be wondered just what effect this will have upon the chronograph. This effect is explained in the following:

In Illustrations 70 and 71, the dart tooth, as it travels counter-clockwise, must move the point of tooth "B" of the intermittent wheel to the dotted line "A" to insure the registration of the minutes. In other words, when the dart tooth moves the point of the intermittent wheel tooth "B" to the dotted line "A", the point of the minute register wheel tooth "D" will have passed over the top of the inclined surface "J" of the minute register pawl, and from this point on, the pawl will force the wheel to complete the registration quickly.

Illustration 70 shows a dart tooth that is extremely long. This dart tooth is in contact with the tooth "B" of the intermittent wheel. To move the point of the intermittent wheel tooth "B" to the dotted line "A", the dart tooth must travel 9 degrees counter-clockwise. It must be kept in mind that each 6 degree movement of the dart tooth counter-clockwise represents 1 second on the dial. Thus, the 9 degree travel of the dart tooth represents  $1\frac{1}{2}$  seconds on the dial. Due to this, the dart tooth must contact the intermittent wheel tooth "B" on the 58th and  $\frac{1}{2}$  second of registration so that exactly  $1\frac{1}{2}$  seconds later, the dart tooth will have moved the point of tooth "B" of the intermittent wheel to the dotted line "A" on the 60th second of registration.

Illustration 71 shows a dart tooth that is short. Observe that this dart tooth is also in contact with the tooth "B" of the intermittent wheel. To move the point of the tooth "B" of the intermittent wheel to the dotted line "A", the dart tooth, because it is short, must travel 18 degrees counter-clockwise. Since 6 degrees movement of the dart tooth represents 1 second, 18 degrees movement of the dart tooth represents 3 seconds on the dial. Due to this, the dart tooth of this length must contact the tooth "B" of the intermittent wheel on the 57th second of registration so that exactly 3 seconds later, the dart tooth would have moved the point of the tooth "B" of the intermittent wheel to the dotted line "A" on the 60th second of registration.

It must also be considered at this point, that the length of the dart tooth has an effect on how much power from the train of the watch is needed for the dart tooth to move the intermittent wheel one tooth.

If the dart tooth is short, as in Illustration 71, there is less drag on the train of the watch as the minute registration is taking place. This is due to the fact that the dart tooth is turning on a smaller radius, which increases its leverage.

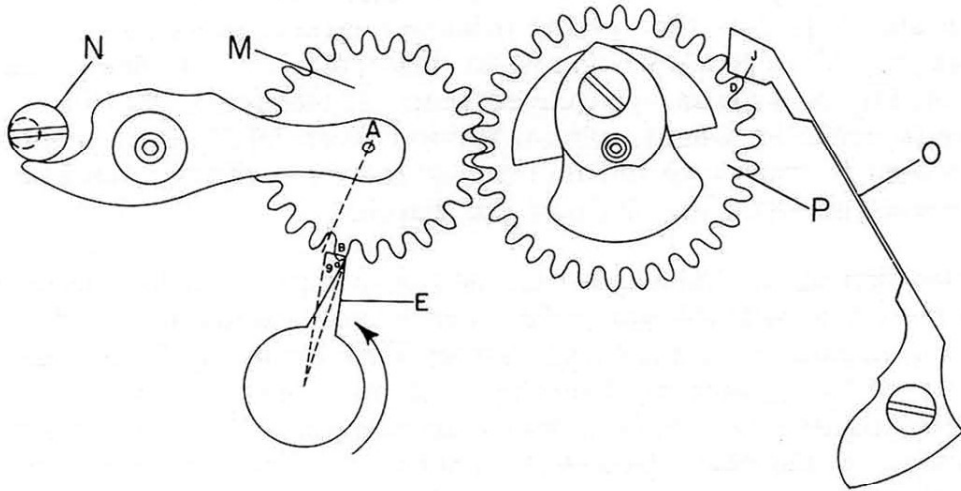

Illustration 70

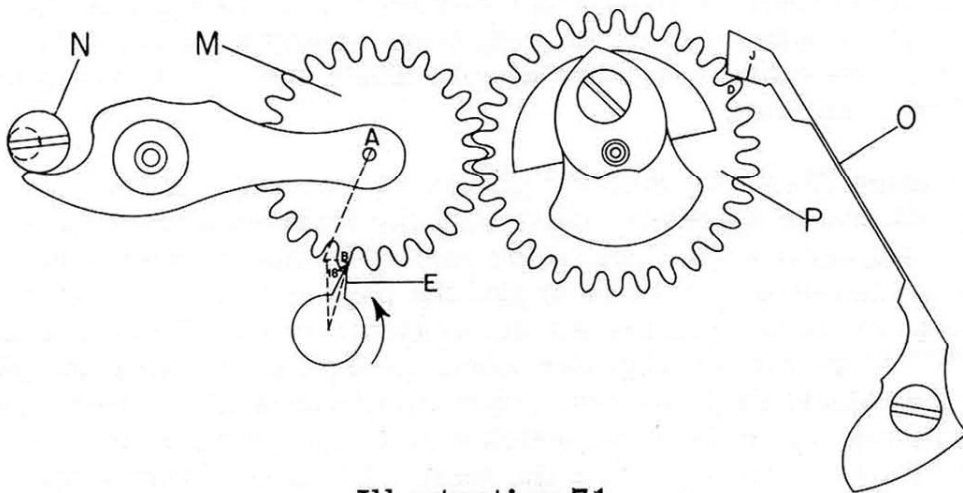

Illustration 71

- |                           |                          |
|---------------------------|--------------------------|
| E - Dart tooth            | N - Eccentric stud       |
| M - Intermittent wheel    | O - Minute register pawl |
| P - Minute register wheel |                          |



## THE ANGLE OF THE INCLINED PLANE OF THE MINUTE REGISTER PAWL AND ITS EFFECT ON THE CHRONOGRAPH

To begin, we will study the effect of the inclined plane of the minute register pawl in relation to the drag on the train of the watch when the registration of the minutes is taking place.

Observe in Illustration 72, the inclined planes "I" and "J" of the minute register pawl. It can be seen in this Illustration that the inclined planes "I" and "J" of the minute register pawl are on a very slight angle. This pawl, as shown in Illustration 72-A, due to the angle of the inclined plane, will cause less resistance to the turning of the minute register wheel. Thus, for the tooth "L" of the minute register wheel to travel up the inclined plane "J", there would be little power required from the train of the watch.

In Illustration 72-B, the tooth "L" of the minute register wheel has passed over the inclined plane "J" and is now on the inclined plane "I" of the minute register pawl. From this point on, the inclined plane "I" of the minute register pawl should force the minute register wheel slightly counter-clockwise to complete the registration of the minutes on the dial. However in this case, because the inclined plane "I" of the minute register pawl is on such a slight angle, tooth "L" of the minute register wheel may remain stationary on the inclined plane "I". In other words, the inclined plane "I" of the minute register pawl may not be on a great enough angle to overcome the friction between the pawl and the tooth "L". This prevents the end "H" of the minute register pawl from centering itself between two teeth of the minute register wheel. Thus, the minute registration will not be completed.

In Illustration 73-A, the inclined planes "I" and "J" of the minute register pawl are on a greater angle than the inclined plane of the pawl shown in Illustration 72. Due to the inclined plane of the minute register pawl being on a greater angle, the pawl will hold a greater resistance to the turning of the minute register wheel. Thus, for the tooth "L" of the minute register wheel to slide up the inclined plane "J" of the minute register pawl, there would be a little more power required from the train of the watch than in the previous type pawl shown in Illustration 72. After the tooth "L" of the minute register wheel has reached the top of the inclined surface "J" of the pawl, Illustration 73-B, the pawl, because of its greater angle of inclined plane, will have the power to force the minute register wheel to quickly rotate counter-clockwise to complete the registration of the minute. Thus, the pawl will center itself between two teeth on the minute register wheel.

From the observation made with reference to Illustration 72, it can be seen that if the inclined planes are on too slight an angle, the minute register pawl would not function correctly, and thus the angle of the inclined plane must be increased, as shown in Illustration 73, even though it would cause a little more drag on the train of the watch.

On the other hand, it must also be kept in mind that if the inclined planes 'I' and 'J' are on too great an angle, the minute register wheel may be held so securely by the minute register pawl that the watch would stop when the registration of the minutes is taking place. This leads to the conclusion that the inclined planes 'I' and 'J' of the minute register pawl should have no greater angle than is required for the proper function of the pawl.

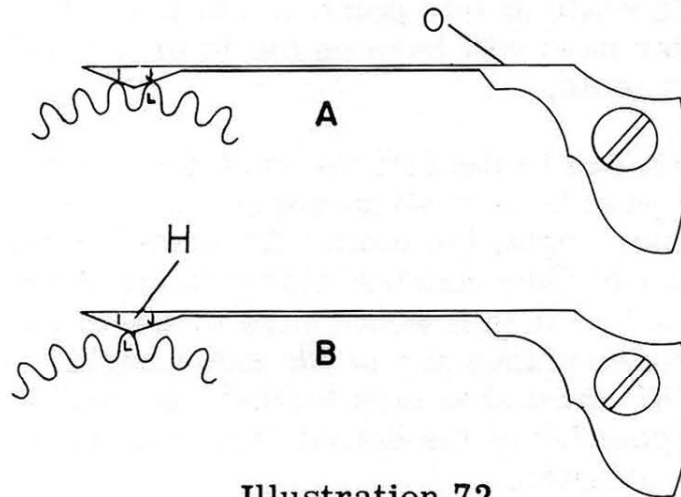

Illustration 72

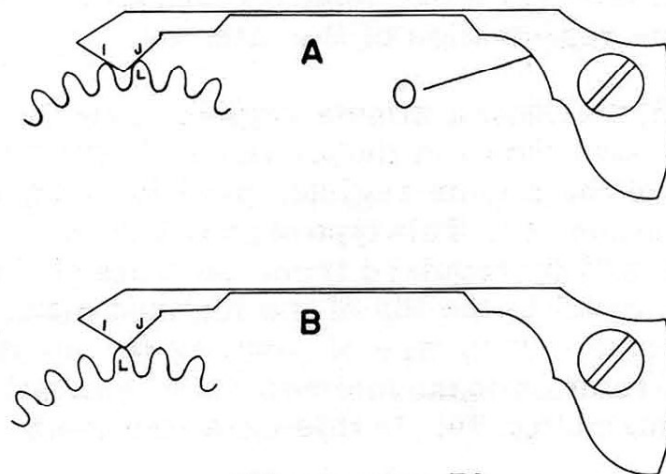

Illustration 73

Some manufacturers reduce the angle of the inclined plane "J" of the minute register pawl and increase the angle of the inclined plane "I" of the pawl. See Illustration 74.

Then as the registration of the minutes is taking place, tooth "L" can slide up the inclined plane "J" of the minute register pawl with the least amount of power required from the train of the watch, and after the tooth "L" of the minute register wheel has passed over the inclined plane "J", the inclined plane "I" will be on a great enough angle to complete the registration of the minutes.

This type of pawl is used in the chronographs which are illustrated in Volumes 1, 8, 18, and 20 in the Esembl-O-Graf Library.

It would be worth while at this point, to study the effect this type of minute register pawl will have on the intermittent wheel in relation to the dart tooth.

In Illustration 74, due to the fact the inclined plane "J" of the minute register pawl is on a slight angle, and the inclined plane "I" is on a greater angle, the tooth "L" of the minute register wheel must travel further counter-clockwise to reach the top of the inclined plane "J" than it would have to travel on a type pawl in which the inclined planes are of the same angle. Due to this, the dart tooth "E" must also turn further counter-clockwise in this case to the position of the dotted dart tooth to insure the registration of the minutes.

Observe in this Illustration, that the dotted dart tooth is closer to tooth "C" of the intermittent wheel than it is to tooth "B". This is due to the fact the dart tooth must travel further counter-clockwise to insure the registration of the minutes.

In Illustration 75, we show a minute register pawl that is the reverse type of the pawl shown in the previous Illustration. The inclined plane "J" of the minute register pawl is on a greater angle than the inclined plane "I". This type of pawl has the disadvantage that more power will be required from the train of the watch for the tooth "L" to travel to the top of the inclined plane "J" of the minute register pawl. This type of pawl, as far as its effect on the dart tooth in relation to the intermittent wheel, will be the opposite of that in Illustration 74. In this case, the tooth "L" of the

minute register wheel does not have to travel as far counter-clockwise to reach the top of the inclined plane "J". Thus, the dart tooth "E" must only travel to the position of the dotted dart tooth to insure the registration of the minutes. In Illustration 75, it can be observed that the dotted dart tooth is closer to tooth "B" than to tooth "C" of the intermittent wheel. This is due to the fact that the dart tooth did not have to travel as far counter-clockwise to insure the registration of the minutes.

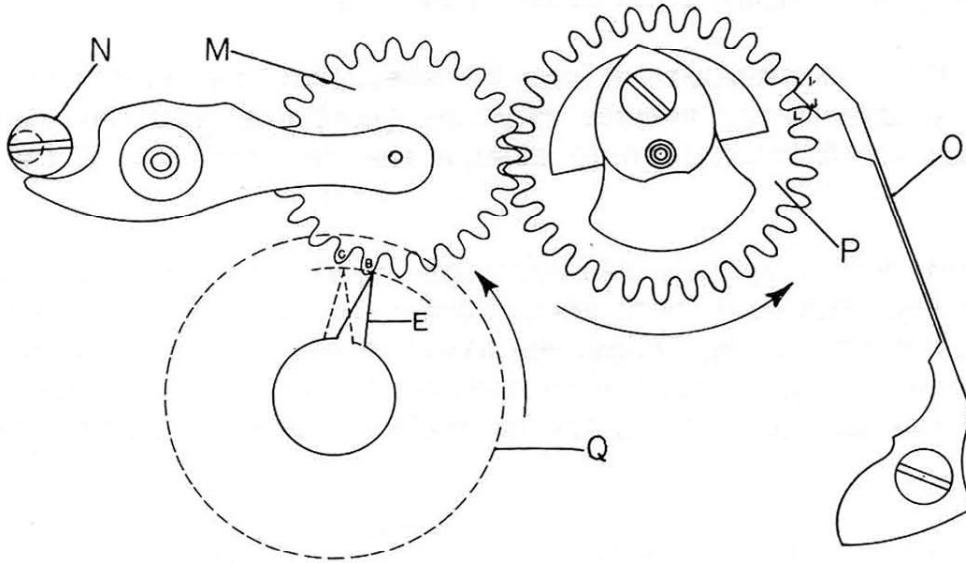

Illustration 74

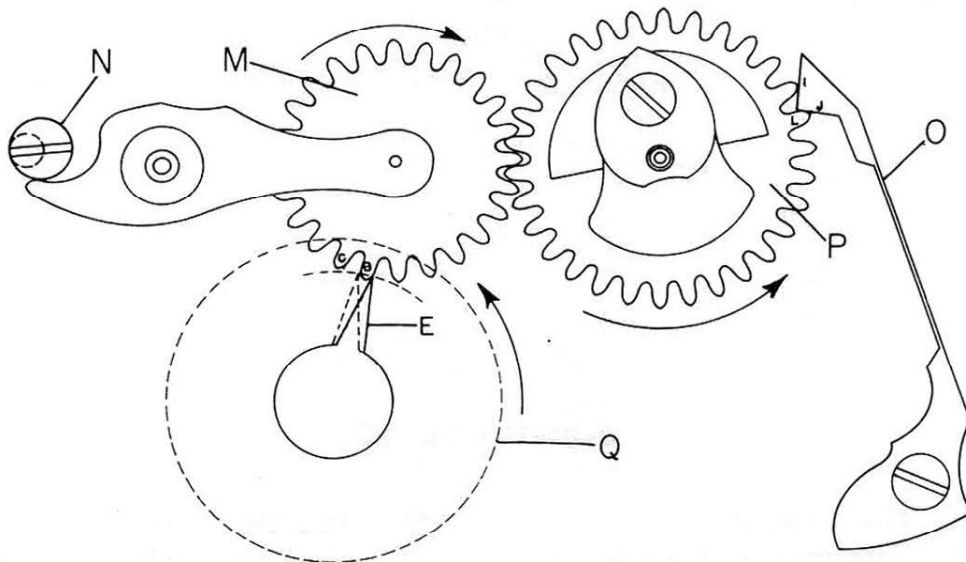

Illustration 75



In Illustration 76, we show a type of minute register pawl in which the inclined planes "J" and "I" are of the same angle. With this type of minute register pawl, the dart tooth "E" must turn to the position of the dotted dart tooth, to insure the registration of the minutes. Observe in this Illustration, that the dotted dart tooth is centered between teeth "B" and "C" of the intermittent wheel.

In Illustrations 74, 75, and 76, the position of the dotted dart tooth indicates how far the dart tooth must turn in order that the tooth of the minute register wheel will pass over the point of the pawl, to insure the registration of the minutes.

From this information, it can be seen that the angles of the inclined planes of the minute register pawl controls the distance the dart tooth must turn to insure the registration of the minutes.

The dotted dart tooth in Illustrations 74, 75, and 76, also shows the position the dart tooth should occupy when the seconds wheel is at a zero position. Thus, the angle of the inclined planes of the minute register pawl also controls to some extent, the position of the dart tooth when the seconds wheel is at a zero position.

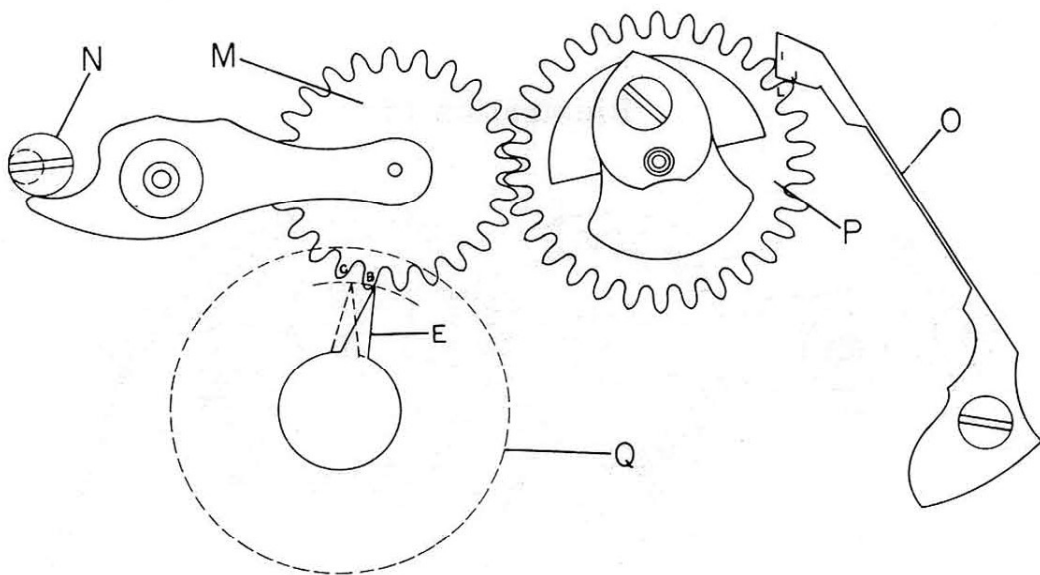

Illustration 76

- |                        |                           |
|------------------------|---------------------------|
| E - Dart tooth         | O - Minute register pawl  |
| M - Intermittent wheel | P - Minute register wheel |
| N - Eccentric stud     | Q - Seconds wheel         |

## ADJUSTABLE MINUTE REGISTER PAWL

Many manufacturers place the minute register pawl on a slide which is attached to the barrel plate by a shouldered screw. See Illustration 77. This slide sets down in a recess in the barrel plate so that the minute register pawl will be of the correct height to mesh properly with the teeth of the minute register wheel. The slide "K" and the minute register pawl which is attached to it, can be adjusted backwards or forwards, either in the direction of arrow "F" or "G" by loosening the shouldered screw "T". This arrangement for the adjustment of the minute register pawl eliminates the necessity of performing the somewhat delicate job of retouching the inclined planes "I" and "J" of the minute register pawl for the purpose of shifting the position of the minute register wheel.

### NOTE

When disassembling the chronograph, it is not necessary to remove the slide "K", Illustration 77, from the barrel plate. All that is necessary, is to remove the minute register pawl from the slide. Thus, when assembling the chronograph, the minute register pawl can be replaced in the same position it held before it was disassembled.

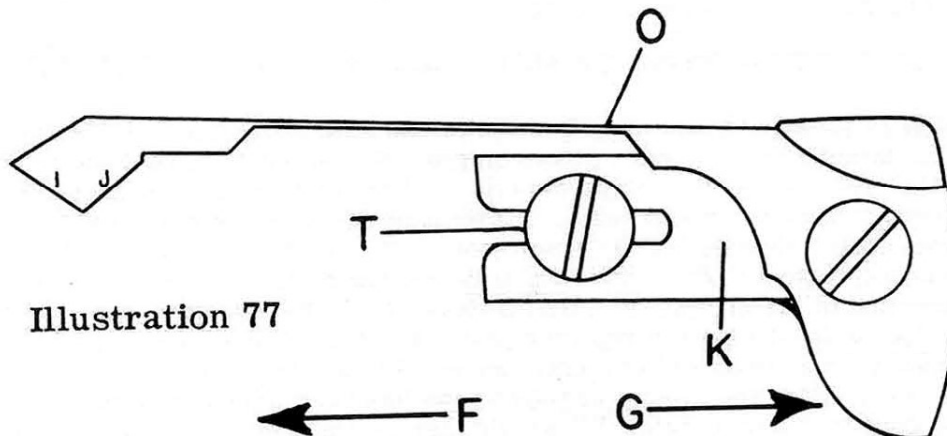

Illustration 77

The minute register pawl as shown in this Illustration, is used in the type of chronograph illustrated in the Esembl-O-Graf Library, Volumes 2 and 9.

It is worthwhile at this point, to mention that the effect of the inclined planes "I" and "J" of the minute register pawl can be changed by shifting the position of the end "H" of the minute

register pawl on the minute register wheel.

To illustrate this, we show in Illustrations 78-A, 78-B, and 78-C, the minute register pawl in three different positions on the minute register wheel.

In Illustration 78-A, we show the minute register pawl centered between teeth "B" and "C" of the minute register wheel. Observe in this Illustration, the inclined planes "I" and "J" are on the same angle of incline in relation to the teeth "B" and "C" of the minute register wheel.

In Illustration 78-B, we show the minute register pawl after it has been shifted in the direction of the arrow, placing the end "H" of the minute register pawl centered between teeth "C" and "D" of the minute register wheel. It can be seen in this Illustration that the effect of the minute register pawl on the minute register wheel would be the same as if the angle of the inclined plane "J" of the minute register pawl was increased, and the angle of the inclined plane "I" of the minute register pawl decreased.

In Illustration 78-C, we show the end "H" of the minute register pawl centered between teeth "A" and "B" of the minute register wheel, which resulted from moving the pawl in the direction of the arrow.

The effect of the minute register pawl on the minute register wheel in this position would be the opposite of that shown in Illustration 78-B. The effect of the pawl on the minute register wheel, Illustration 78-C, would be the same as if the angle of the inclined plane "J" of the minute register pawl was decreased, and the angle of the inclined plane "I" was increased. Thus, it can be seen in Illustrations 78-A, 78-B, and 78-C, that by merely shifting the pawl either forwards or backwards, the effect would be the same as that of changing the inclined planes of the minute register pawl.

The effect on the chronograph from changing the inclined planes of the minute register pawl is explained on pages 61 to 65.

#### SOME OTHER TYPES OF ADJUSTABLE MINUTE REGISTER PAWLS

Illustration 79 shows another arrangement for an adjustable type minute register pawl. This minute register pawl pivots on pin "N", which is affixed to the detent lever "M". The spring "K" holds the end "T" of the minute register pawl engaged with the minute register wheel teeth. Illustration 80 shows how the pivoted detent "M" pivots on the shoulder of the steel stud "R". When the screw "E" is loosened, and the eccentric stud "O" is turned clockwise, the minute register pawl will move in the direction of the arrow, "F", Illustration 79. If the eccentric stud is turned counter-clockwise, the minute register pawl will move in the direction of the arrow "G". Thus, it is evident that the pawl can be adjusted by merely turning the eccentric stud "O". After the minute register pawl has been adjusted by turning the eccentric stud "O", the screw "E" should then be tightened, thus preventing any change in the adjustment. This type of minute register pawl has an advantage over the type of minute register pawl shown in Illustration 77, in as much as small micrometric adjustments in the shifting of the minute register pawl can be made with ease, by turning the eccentric stud only a slight amount. In a type of pawl as shown in Illustration 77, a small micrometric adjustment in the shifting of the pawl is more difficult to obtain.

Also, it should be taken into consideration that the type of pawl as shown in Illustration 79, is a more sturdy type of pawl, and thus could not be broken as easily as the type of pawl in which the pawl itself acts as a spring. The minute register pawl as shown in this Illustration, is used in the type of chronograph illustrated in the Esembl-O-Graf Library, Volumes 11 and 14, and a similar principle in Volume 17.

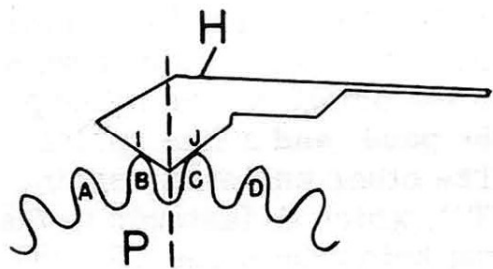

Illustration 78-A

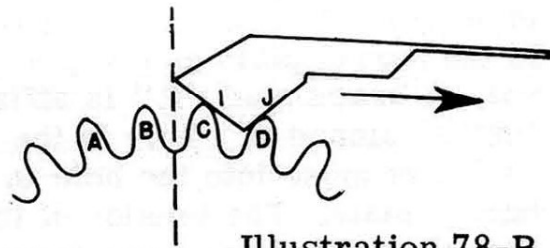

Illustration 78-B

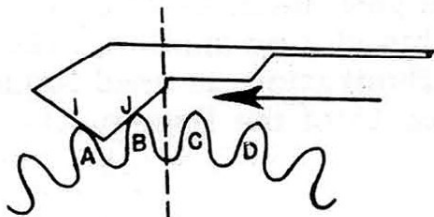

Illustration 78-C

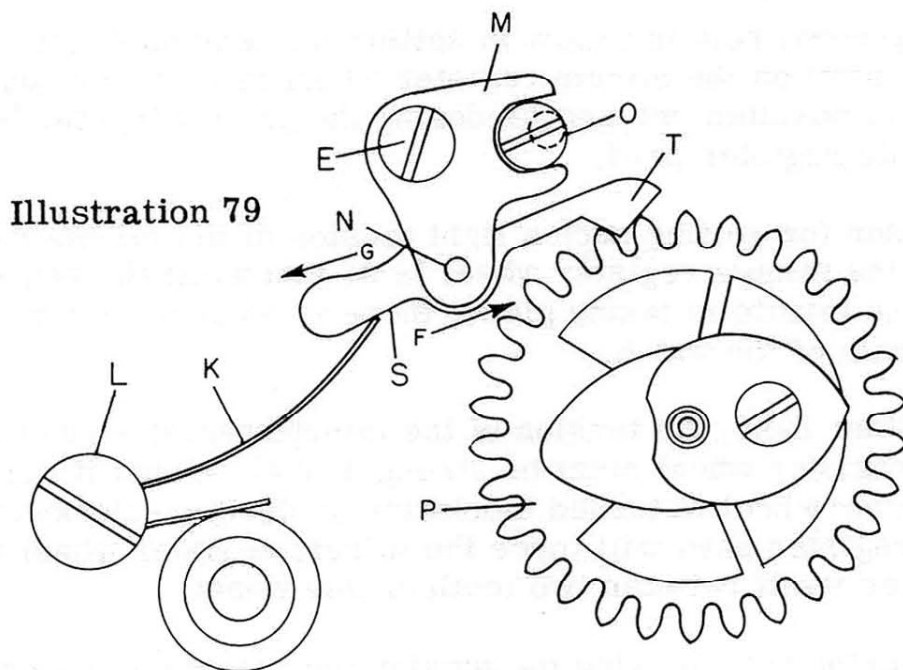

Illustration 79

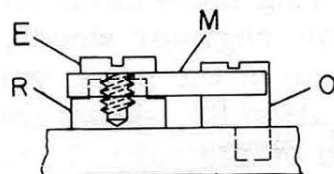

Illustration 80

E - Screw  
 K - Minute register pawl spring  
 L - Shouldered screw  
 M - Pivoted detent

O - Eccentric stud  
 P - Minute register wheel  
 R - Steel stud  
 S - Minute register pawl



The minute register pawl, as shown in Illustration 81, has a counterweight "M" on it. This pawl is affixed to a staff which pivots in the barrel plate on one pivot, and in the bridge on the other pivot. A brass stud "R" is affixed to the pawl, and a fine spring "N" is pinned in a hole in the stud. The other end of the spring "N" fits loose into the hole in stud "T", which is fastened to the barrel plate. The tension of this spring holds the stone "P" of the minute register pawl engaged with the teeth of the minute register wheel. To adjust this type of pawl, the stone "P" must be pushed either in or out of the slot in the pawl. To move this stone "P" in or out of the slot of the pawl, the pawl must be heated, due to the fact that the stone is held in this slot by shellac. The minute register pawl, as shown in this Illustration, is used in the type of chronograph illustrated in Volume 15 of the Esembl-O-Graf Library.

#### SETTING THE PROPER TENSION OF THE MINUTE REGISTER PAWL ON THE MINUTE REGISTER WHEEL

A good general rule to follow in setting the tension of the minute register pawl on the minute register wheel is to set as light a tension as possible, without hindering the proper functioning of the minute register pawl.

The reason for setting such a light tension of the minute register pawl on the minute register wheel is so that when the registration of the minute is taking place, there is no unnecessary drag on the train of the watch.

On the other hand, the tension of the minute register pawl on the minute register wheel must be strong enough so that if the minute register wheel is turned clockwise or counter-clockwise, the minute register pawl will force the minute register wheel to turn and center itself between two teeth of this wheel.

A good method of checking the tension the minute register pawl is holding on the minute register wheel, is to place the edge of a screwdriver on the blade of the pawl, very close to the base. (Location "A", Illustration 82, shows the approximate location the screwdriver should be placed.) Then by forcing the screwdriver in the direction of the arrow until the end "H" of the pawl loses contact with the minute register wheel, it can be felt how much tension the end "H" of the pawl was holding on the minute register wheel.

When the tension of the minute register pawl on the minute register wheel is set correctly, just a very light pressure of the screwdriver on the blade of the pawl close to the base, will move the end "H" of the pawl out of contact with the minute register wheel.

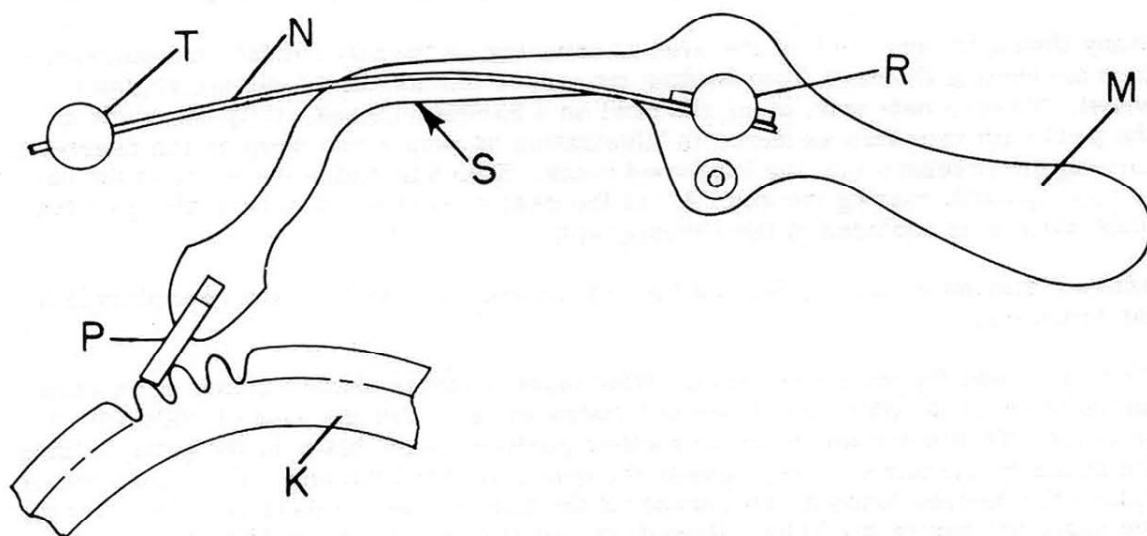

Illustration 81

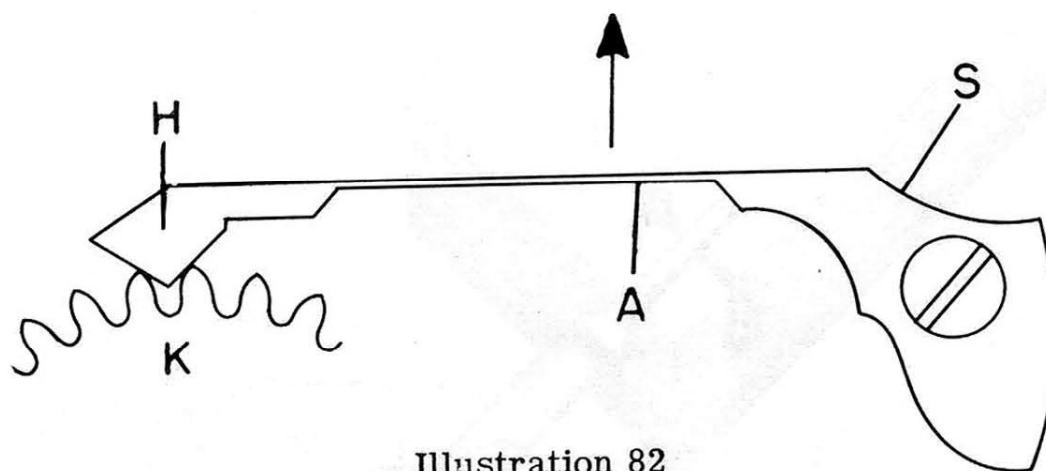

Illustration 82

K - Minute register wheel  
 N - Minute register pawl spring  
 P - Stone

R - Brass stud  
 S - Minute register pawl  
 T - Brass stud

## RELEASING OR ADDING TENSION TO THE MINUTE REGISTER PAWL

To add tension to the minute register pawl on the minute register wheel, place the minute register pawl on a hardwood block. See Illustration 83. Now place a burnisher on the blade of the pawl. Press down lightly on the burnisher, and rub back and forth on the blade of the pawl. This will cause the blade to curve slightly upward, so that when the pawl is replaced in the chronograph, it will hold a greater tension on the minute register wheel. To release the tension of the pawl on the minute register wheel, the reverse side of the pawl is rubbed with the burnisher.

Many times, the end "A" of the pawl is scraping on the plate of the chronograph, thus preventing the pawl from holding its proper tension on the minute register wheel. To eliminate this, place the pawl on a hardwood block. Grip the blade of the pawl with tweezers as shown in Illustration 84, and press down on the tweezers, forcing the tweezers into the hardwood block. This will cause the blade of the pawl to bend upward, raising the end "A" of the pawl preventing it from rubbing on the plate when it is replaced in the chronograph.

Another method of raising the end "A" of the minute register pawl is explained in the following:

Place the pawl flat on a steel anvil. Now place a chisel shaped punch on an angle on the blade of the pawl, as shown in Illustration 85. Tap the punch lightly with a hammer. Then move the punch to another position on the blade of the pawl, holding the punch on the same angle. Repeat the operation until the end "A" of the pawl is raised the desired amount. Of course, if the end "A" of the pawl is to be lowered, the same procedure would be followed, except that the punch would be placed on the opposite edge of the pawl.

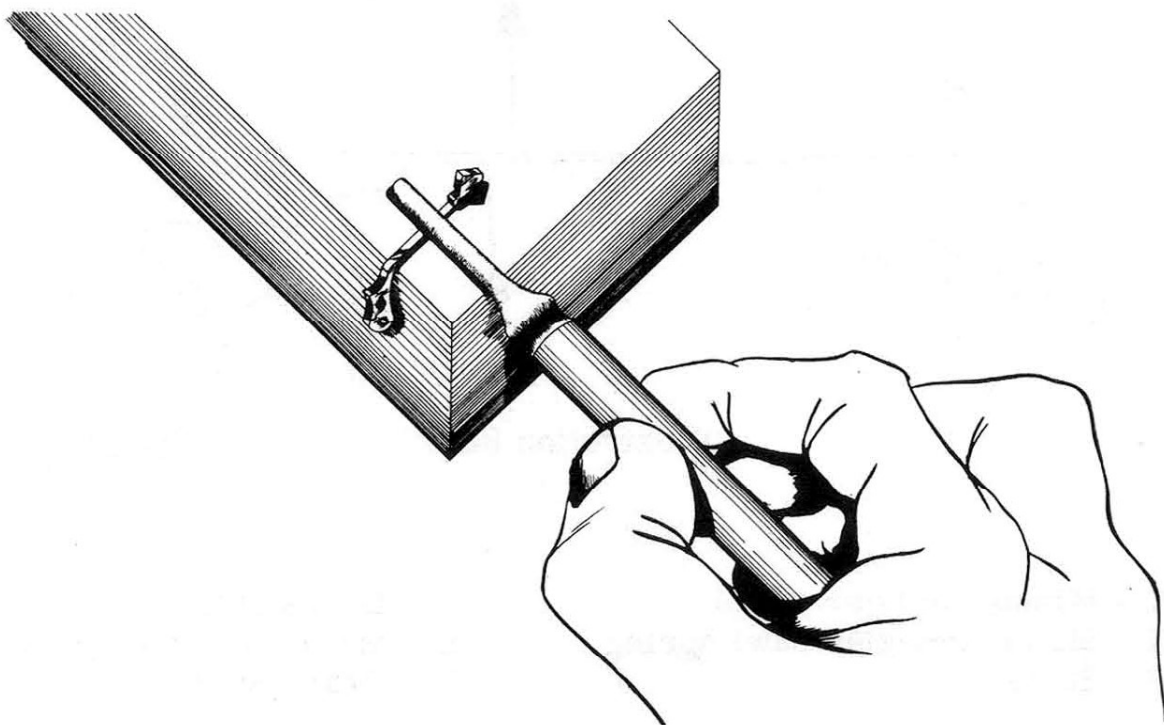

Illustration 83

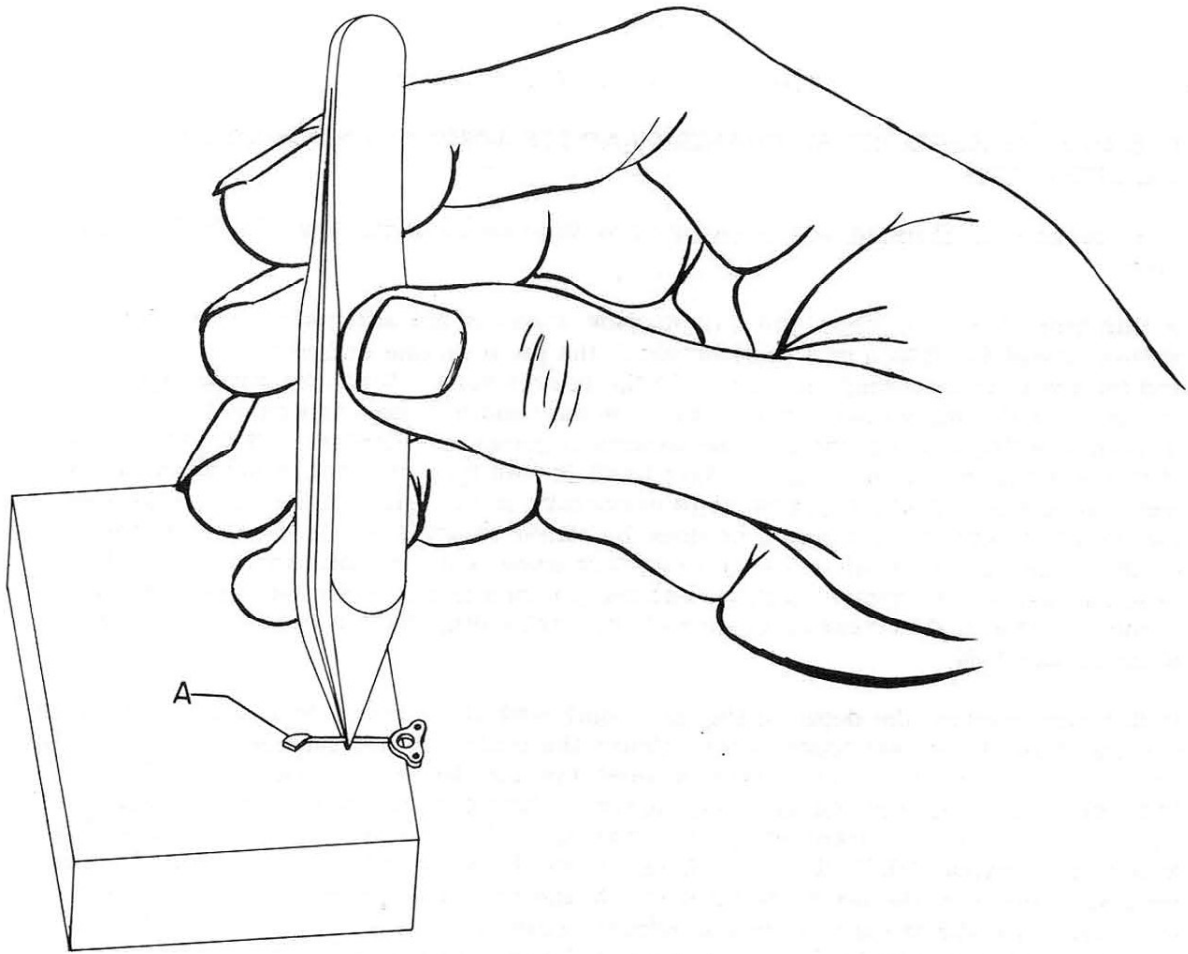

Illustration 84

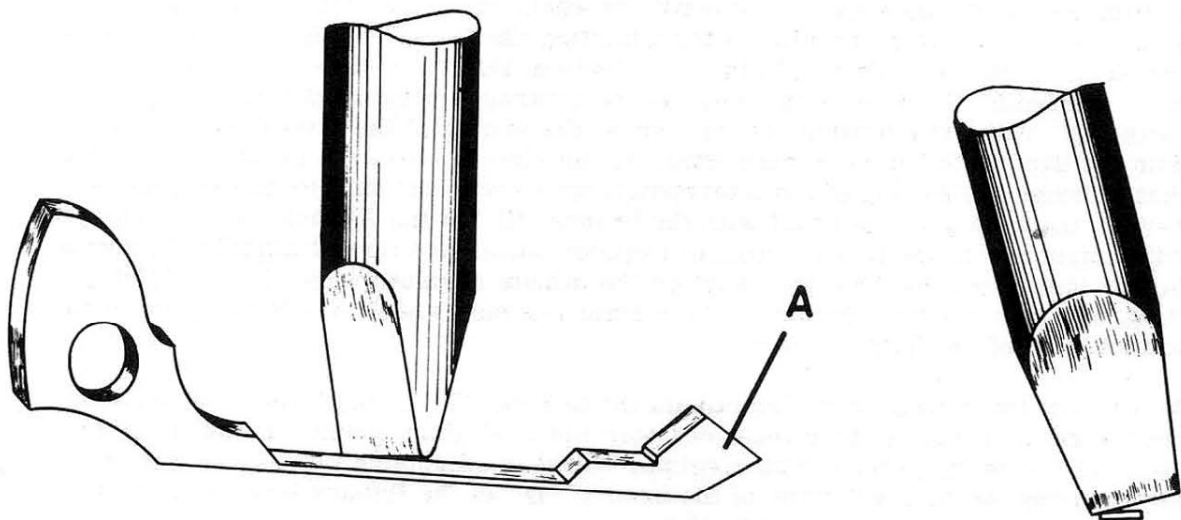

Illustration 85



## PART 7

### THE PIERCE CHRONOGRAPH

#### THE MINUTE REGISTER MECHANISM AND ITS ADJUSTMENT IN THE PIERCE CHRONOGRAPH

The Pierce type chronograph is covered by Volume 15 of the Esembl-O-Graf Library.

In this type of chronograph, the intermittent wheel is not adjustable. This intermittent wheel is affixed to a staff in which the pivot on one end pivots in a bridge, and the pivot on the other end pivots in the barrel plate. With this arrangement, the depth of the intermittent wheel with the dart tooth is set, and cannot be changed without altering certain parts of the minute register mechanism. Thus, the depth of the intermittent wheel with the dart tooth in this type of mechanism very seldom needs adjusting. If any adjustment is necessary in the depth of the dart tooth with the intermittent wheel, it would be done by either lengthening or shortening the dart tooth. Although the depth of the intermittent wheel with the dart tooth very seldom needs adjusting, the intermittent wheel many times is out of adjustment in regards to the entering and leaving clearance of the dart tooth. Such a condition is shown in Illustration 86.

In this Illustration, the depth of the dart tooth with the intermittent wheel is correct, but the point of the dart tooth barely clears the tooth "A" of the intermittent wheel, while there is excessive clearance between the dart tooth and tooth "C". To correct this condition, and equalize the clearance between the dart tooth and teeth "A" and "C" of the intermittent wheel, we must change the position of the intermittent wheel so that tooth "B" will be centered on the imaginary line "T", which is drawn from the center of the intermittent wheel to the center of the dart tooth. To do this, we must move the stone "E" in the minute register pawl in the direction of the arrow, which would be back into the slot of the minute register pawl. This will move the minute register wheel slightly clockwise, thus moving the intermittent wheel slightly counter-clockwise. The stone "E" in the minute register pawl should be moved until there is equal clearance between the dart tooth and the teeth "A" and "C" of the intermittent wheel.

In Illustration 87, we show the intermittent wheel in its correct position in relation to the dart tooth, which resulted after adjusting the stone "E" in the minute register pawl. It can be observed in this Illustration, that the clearance between the dart tooth and tooth "A" is now the same as the clearance between the dart tooth and tooth "C" of the intermittent wheel. Thus, the setting of the intermittent wheel with the dart tooth has been corrected. It can also be observed in this Illustration, that although the setting of the intermittent wheel with the dart tooth has been corrected, the setting of the heart with the branch "D" of the flyback lever is out of adjustment due to the fact the minute register wheel was turned slightly clockwise. In this type of mechanism, the heart on the minute register wheel is only friction tight, and thus can be adjusted on the minute register wheel to suit the angle of the branch "D" of the flyback lever.

To correct the setting of the heart with the branch "D" of the flyback lever, we must turn the heart on the minute register wheel slightly counter-clockwise. The fact that the heart on the minute register wheel is adjustable eliminates any need for changing the inclined plane of the branch "D" of the flyback lever to correct the condition shown in this Illustration.

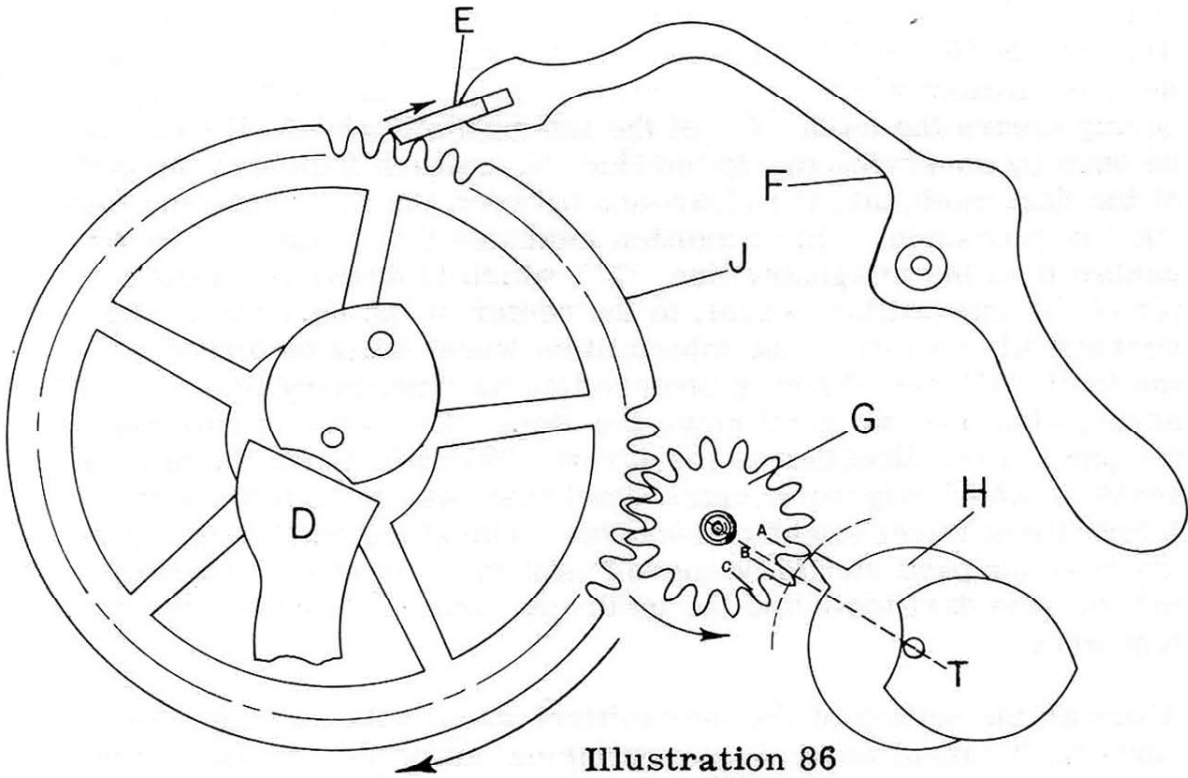

Illustration 86

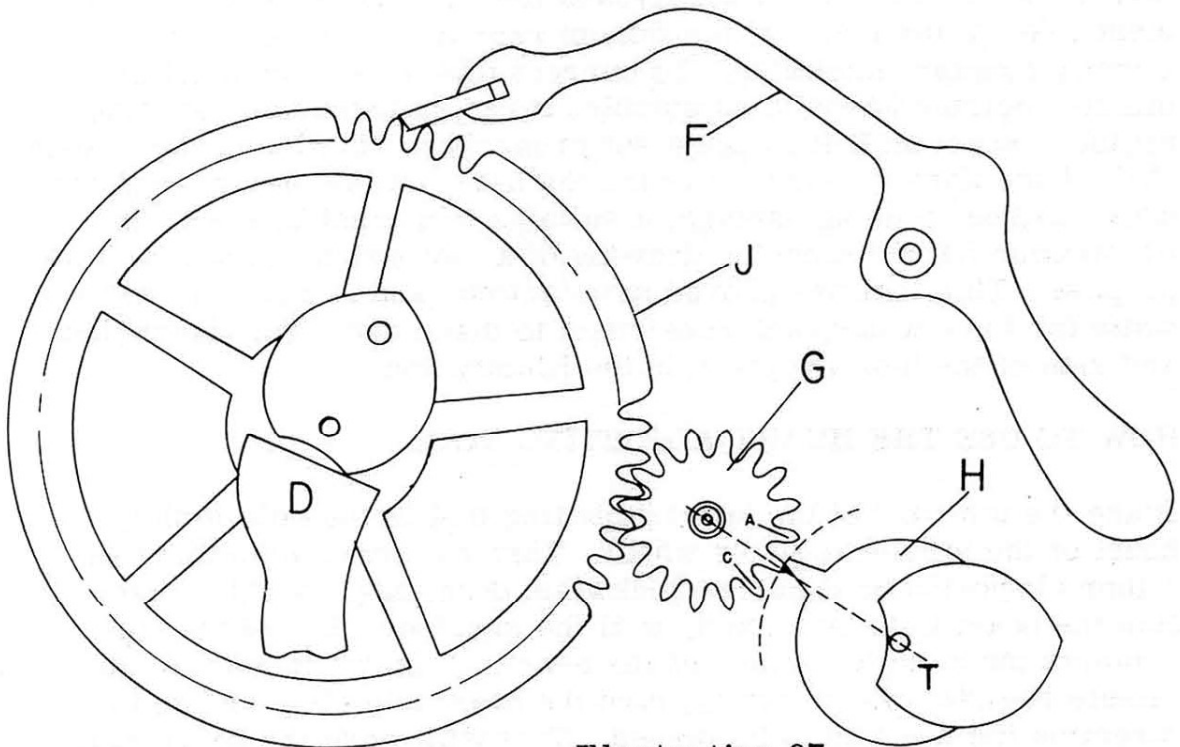

Illustration 87

D - Branch of flyback lever  
 E - Stone  
 F - Minute register pawl

G - Intermittent wheel  
 H - Dart tooth  
 J - Minute register wheel

In Illustration 88, we show the reverse condition of that shown in Illustration 86. In this Illustration, the depth of the dart tooth with the intermittent wheel is correct, but the point of the dart tooth barely clears the tooth "C" of the intermittent wheel. It can also be seen by observing the dotted line "K", which indicates the path of the dart tooth, that the clearance between the dart tooth and tooth "A" is excessive. This condition indicates that tooth "B" is not centered on the imaginary line "T", which is drawn from the center of the intermittent wheel, to the center of the dart tooth. To correct this condition, the intermittent wheel must be turned until the tooth "B" lies directly centered on the imaginary line "T". To accomplish this, we must move the stone "E" in the minute register pawl in the direction of the arrow. This will move the minute register wheel slightly counter-clockwise, and in turn move the intermittent wheel slightly clockwise. The stone "E" in the minute register pawl should be moved until there is equal clearance between the dart tooth and the teeth "A" and "C" of the intermittent wheel.

Although the setting of the intermittent wheel with the dart tooth is correct, it cannot be avoided mentioning, as in the previous case, that the setting of the heart on the minute register wheel, in relation to the branch "D" of the flyback lever, would be out of adjustment, due to the fact that the minute register wheel was turned slightly counter-clockwise. To correct this, since the heart on the minute register wheel is adjustable, it can be turned on the minute register wheel until it is again set properly in relation to the branch "D" of the flyback lever. To turn the heart on the minute register wheel without causing damage, a suitable tool must be used. In Illustration 89, we show the drawing of a tool which is used for this purpose. This tool has proved satisfactory, and it would be worth while for the chronograph repairman to make one. The dimensions and size of the tool are given in the Illustration.

#### HOW TO USE THE HEART ADJUSTING TOOL

Place the pin "L" of the heart adjusting tool in the hole in the heart of the minute register wheel. Turn the heart adjusting tool either clockwise or counter-clockwise, depending on which direction the heart is to be turned, until the shoulder "M" of the tool contacts the outside surface of the heart. Then while holding the minute register wheel firmly, turn the heart adjusting tool in the direction the heart is to be turned. This will move the heart with the least chance of slippage or damage to the part.

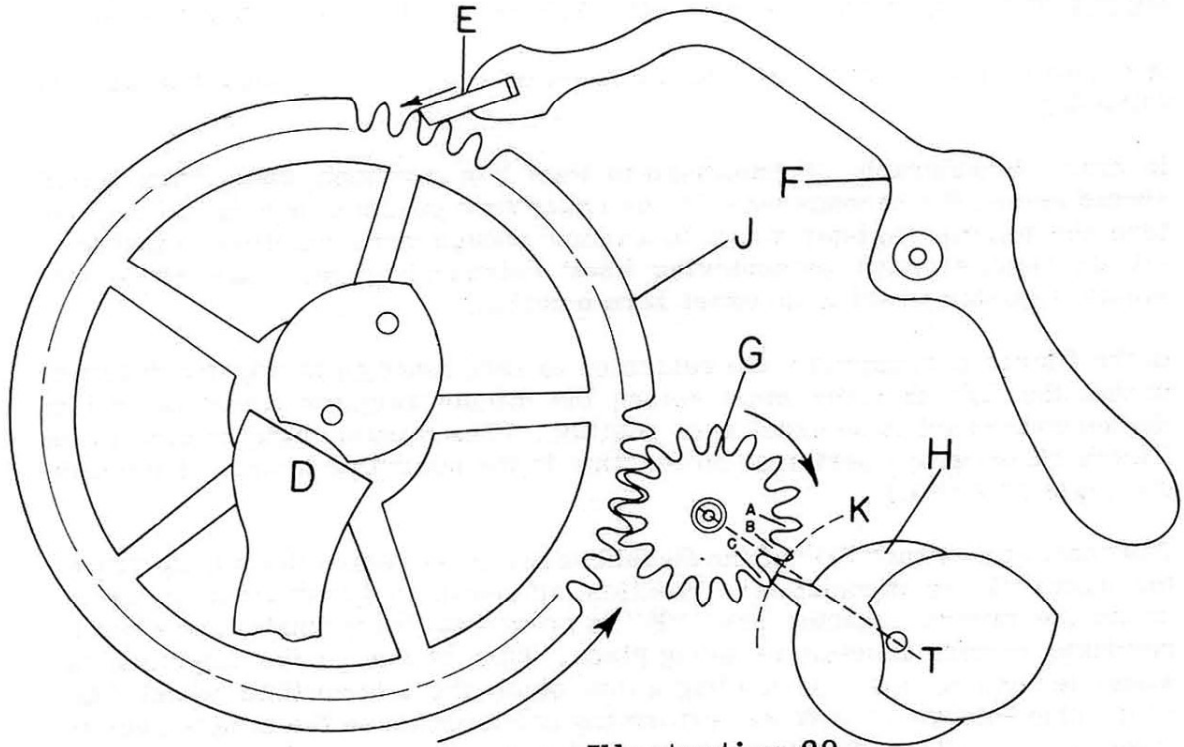

Illustration 88

HEART ADJUSTING TOOL

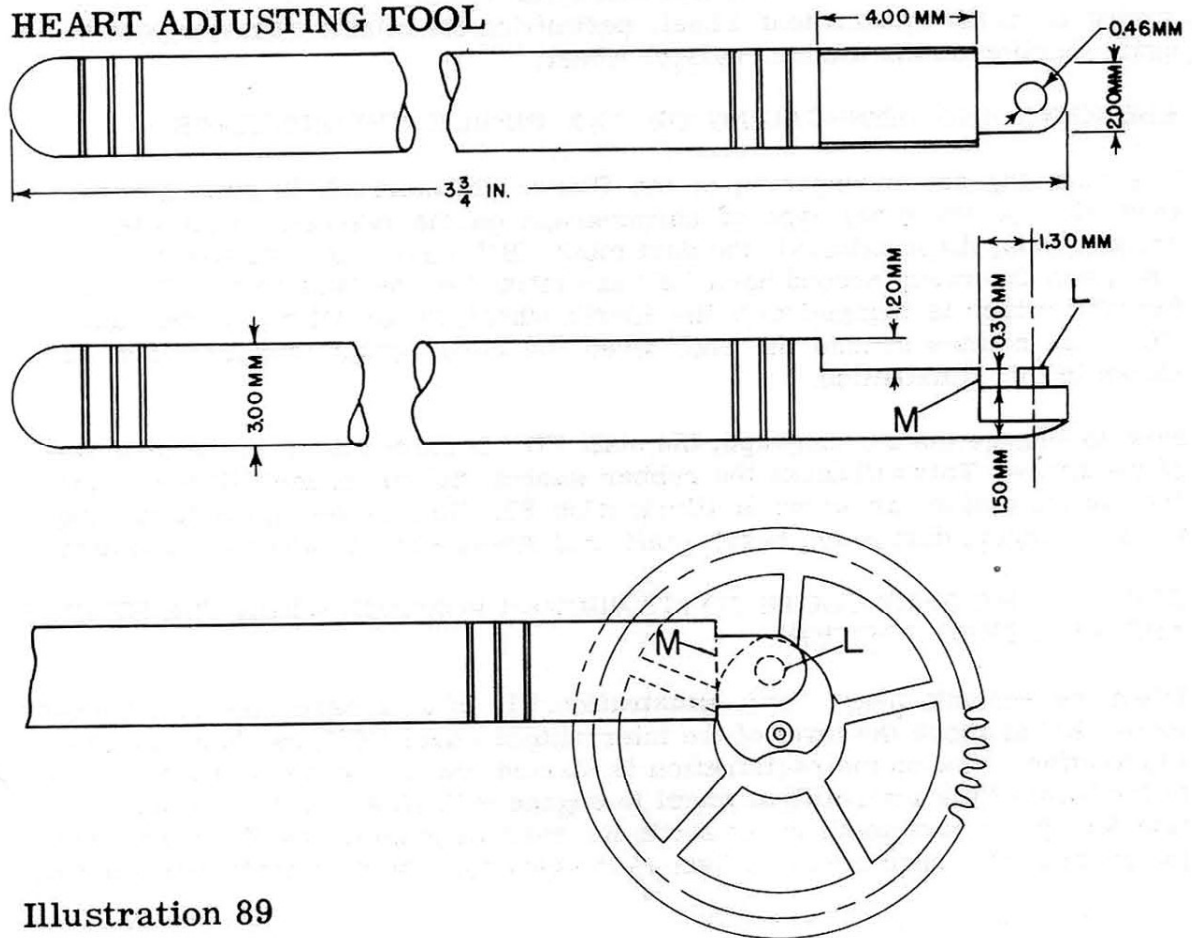

Illustration 89



## RETURNING TO ZERO OF THE HEARTS IN A PIERCE CHRONOGRAPH

It is recommended that Part 1 in this book be read before proceeding with the following.

In most chronograph, as explained in Part 1 in this book, the flyback lever should return the seconds wheel to an exact zero position, but should only return the minute register wheel to a close enough zero position so that the minute register pawl, by centering itself between two teeth, can return the minute register wheel to an exact zero position.

In the Pierce chronograph, the returning to zero function is slightly different, in that the flyback lever must return the minute register wheel as well as the seconds heart to an exact zero position. (The minute register pawl in the Pierce chronograph performs no function in the returning to zero of the minute register wheel.)

The reason the branch "D" of the flyback lever must return the minute register wheel "J" to an exact zero position, as shown in Illustration 90, is because the minute register pawl "F" is prevented from functioning when the returning to zero function is taking place. This is due to the intermittent wheel tension spring "O" holding a tension on the intermittent wheel "G" which prevents the pawl from performing any function on the minute register wheel at this time. After the chronograph has been returned to zero, and the chronograph registration is started, the intermittent wheel tension spring will be forced downward. This will disengage the intermittent wheel tension spring from the intermittent wheel, permitting the minute register pawl to again function on the minute register wheel.

## ENGAGING AND DISENGAGING OF THE PIERCE CHRONOGRAPH

The engaging and disengaging of the Pierce chronograph is quite different from that of any other type of chronograph on the market. In the Pierce chronograph, Illustration 91, the dart tooth "H", heart "P", rubber washer "R", and the sweep second hand "S" are affixed to the staff "U". The pinion "Z" which is engaged with the fourth wheel, is not affixed to the staff "U", but rotates around the staff when the chronograph is disengaged, as shown in this Illustration.

Now to engage the chronograph, the staff "U" is forced down in the direction of the arrow. This will cause the rubber washer "R" to engage with the points "V" of the pinion, as shown in Illustration 92. Now as the pinion turns, the rubber washer, dart tooth, heart, staff, and sweep second hand will also turn.

## SETTING THE DART TOOTH TO ITS PROPER POSITION WHEN THE HEARTS ARE AT A ZERO POSITION

When the seconds heart "P", Illustration 91, is at a zero position, the dart tooth "H" is above the level of the intermittent wheel "G", as shown in this Illustration. Now as the registration is started, the dart tooth will move down to the level of the intermittent wheel to engage with it, as shown in Illustration 92. If the dart tooth is not set in its correct position on the staff when the heart is at a zero position, then as the chronograph registration is started,

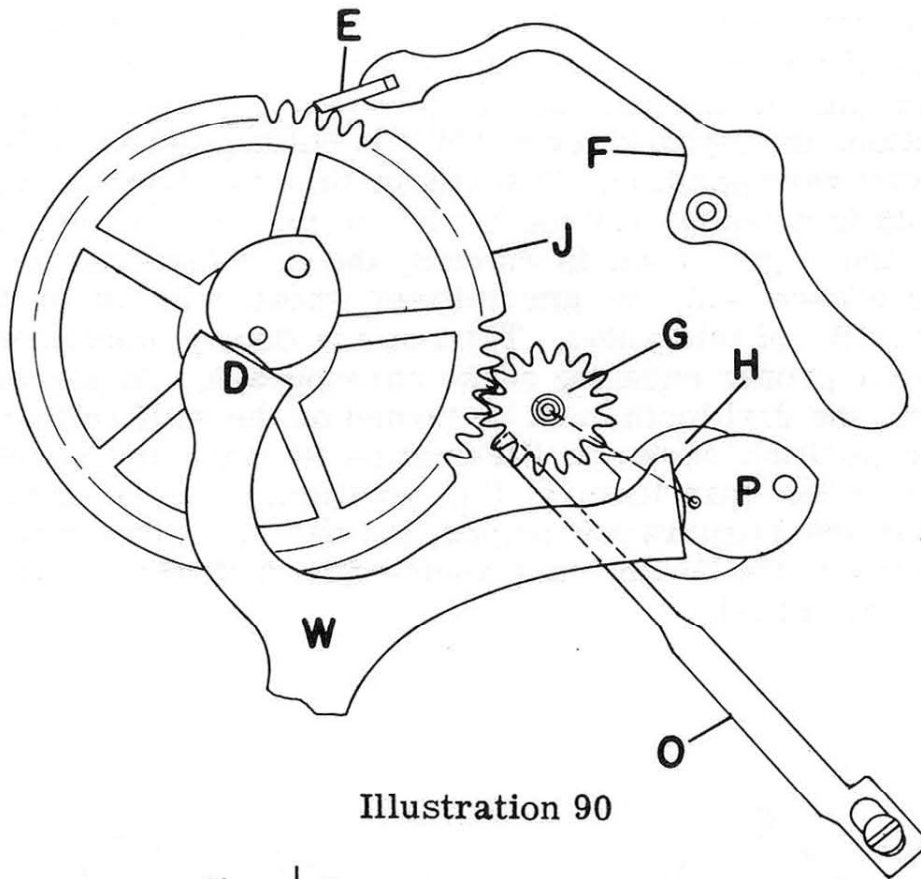

Illustration 90

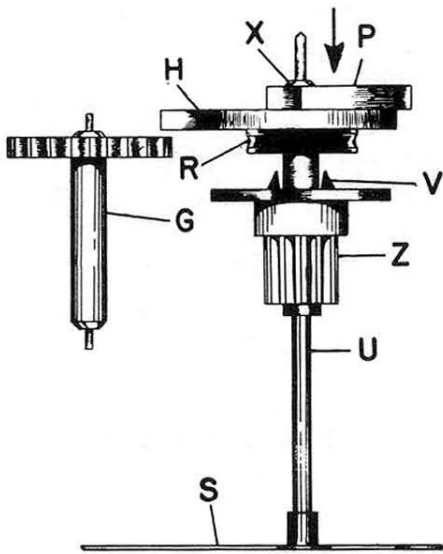

Illustration 91

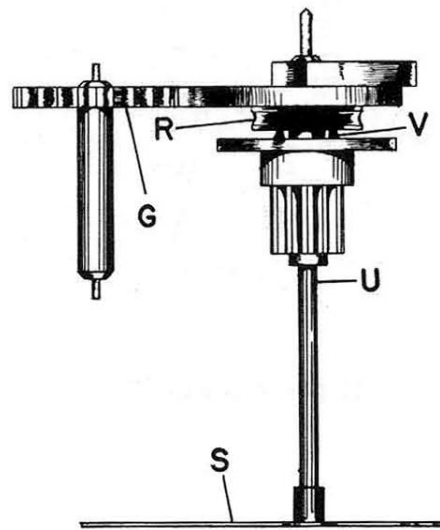

Illustration 92

- E - Stone
- F - Minute register pawl
- G - Intermittent wheel
- H - Dart tooth
- J - Minute register wheel
- O - Intermittent wheel tension spring
- P - Seconds heart

- R - Rubber washer
- S - Sweep second hand
- U - Staff
- W - Flyback lever
- X - Chronograph staff
- Z - Chronograph pinion

the dart tooth may come down right on top of one of the teeth of the intermittent wheel and prevent the proper engaging of the chronograph. Such a condition is shown in Illustration 93. In this Illustration, the flyback lever "W" is holding the seconds heart at an exact zero position. Observe in this Illustration that the dart tooth is directly over tooth "B" of the intermittent wheel. Now as the registration is started, the dart tooth, as it moves down to engage with the intermittent wheel, will hit on top of the tooth "B" of this wheel. This, as previously mentioned, will prevent the proper engaging of the chronograph. To correct this condition, the dart tooth must be turned on the staff so that it will hold the position shown in Illustration 94 when the heart is at zero. .With the dart tooth in this position, it can be easily seen that when the registration begins, the dart tooth can move down to the level of the intermittent wheel without hitting on top of a tooth on this wheel.

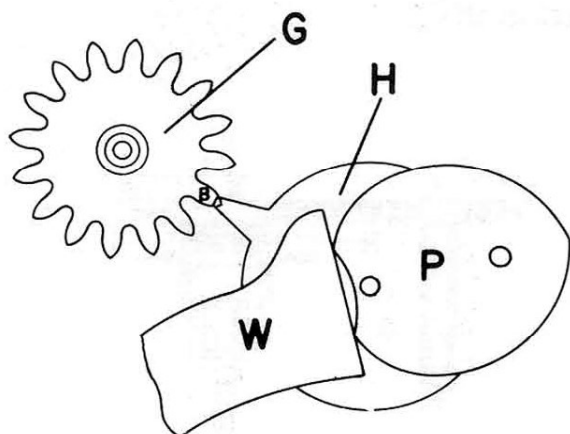

Illustration 93

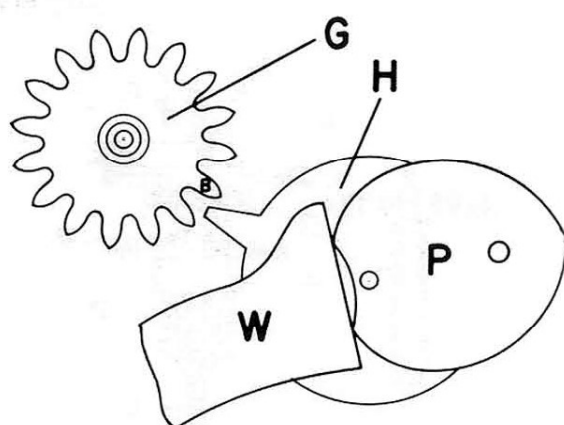

Illustration 94

G - Intermittent wheel  
H - Dart tooth

P - Seconds heart  
W - Flyback lever

The same condition of the dart tooth coming down on top of a tooth of the intermittent wheel, as shown in Illustration 93, can occur if the intermittent wheel tension spring "O", Illustration 95, does not hold the proper tension on the intermittent wheel "G" when the chronograph is disengaged. In Illustration 95, we show in Illustration 95, the dart tooth at a position just before completing a minute registration. The amount the minute register wheel has turned can be seen by observing how far the tooth "A" of the minute register wheel traveled up the inclined plane of the minute register pawl. At this time, if the dart tooth is raised above the level of the intermittent wheel due to the chronograph being disengaged, the intermittent wheel tension spring "O" will contact the intermittent wheel to prevent the minute register pawl from centering itself between two teeth of the minute register wheel. When the dart tooth is raised above the level of the intermittent wheel, it is imperative that the minute register pawl is not permitted to center itself between two teeth of the minute register wheel.

In order to illustrate the reason for this, it would be better to illustrate what would happen if the minute register pawl was permitted to center itself between two teeth of the minute register wheel when the dart tooth is raised above the level of the intermittent wheel "G". In Illustration 95, it can be seen that for the minute register pawl to center itself between two teeth, the minute register wheel would turn slightly in a clockwise direction. This would force the intermittent wheel slightly counter-clockwise, placing the tooth "B" of the intermittent wheel under the dart tooth. Now as the chronograph is engaged again, the dart tooth will come down on top of the tooth "B" of the intermittent wheel. Of course, as previously explained, this could not happen when the intermittent wheel tension spring contacts the intermittent wheel to prevent any turning of this wheel when the chronograph is disengaged.

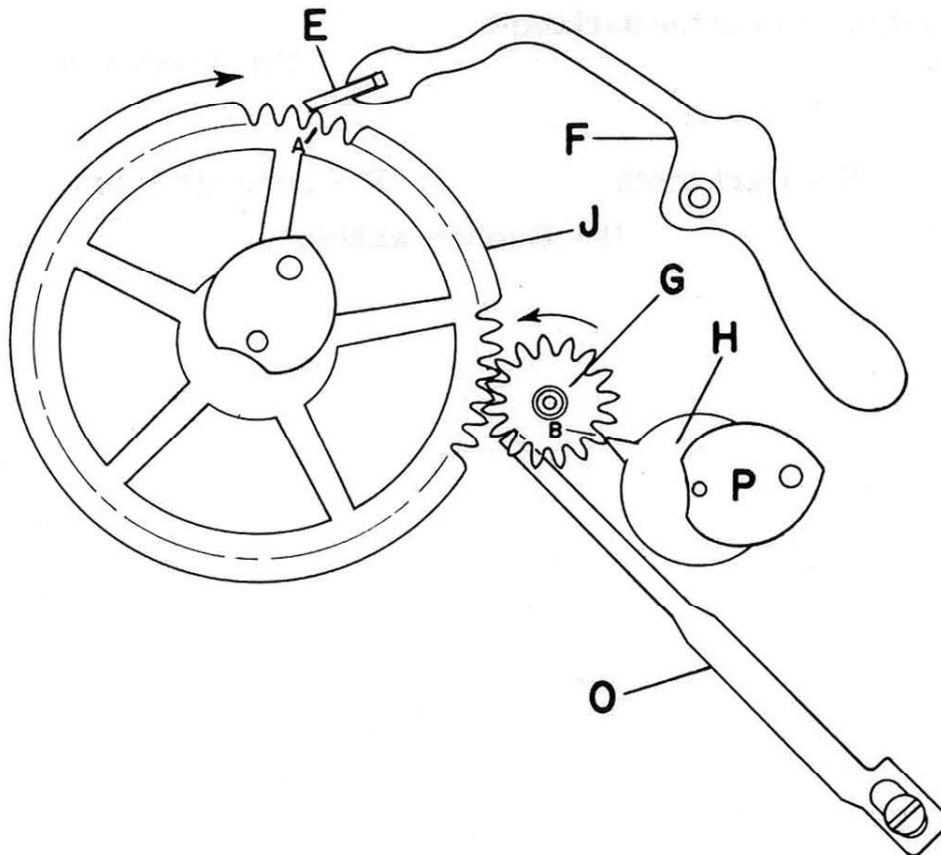

Illustration 95



## TURNING THE DART TOOTH ON THE CHRONOGRAPH STAFF IN A PIERCE CHRONOGRAPH

Grip the heart adjusting tool in a bench vise. (Dimensions for making a heart adjusting tool are shown on Page 76.) Place the hole in the heart over the pin in the heart adjusting tool. Now place the blade of a screwdriver in the slot "A", Illustration 96, in the dart tooth and turn the dart tooth in the desired direction. The heart butting against the shoulder of the heart adjusting tool prevents the heart and staff from turning when the dart tooth is turned. Also, when turning the dart tooth, the screwdriver blade should be turned so as to spread the slot in the dart tooth, thus making it easier for the dart tooth to turn.

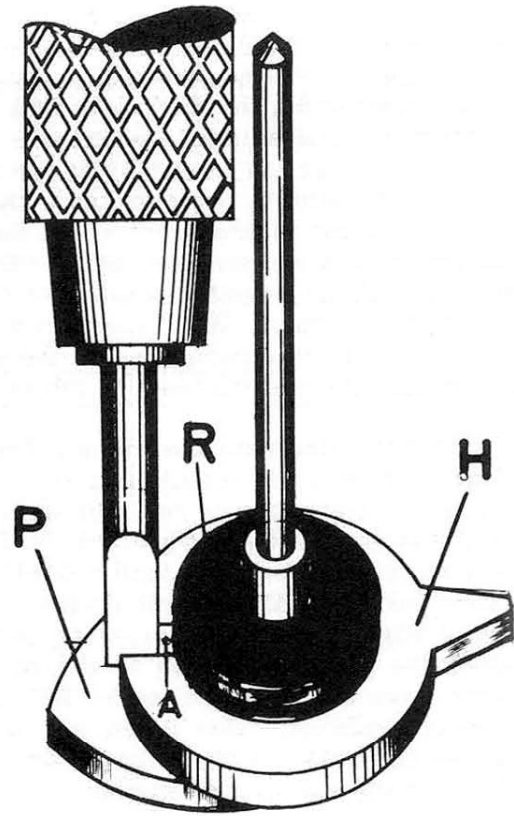

Illustration 96

H - Dart tooth

P - Seconds heart

R - Rubber washer

## PART 8

### SECONDS WHEEL TENSION SPRING AND ITS ADJUSTMENT

#### SETTING THE CORRECT TENSION OF THE SECONDS WHEEL TENSION SPRING AND ELIMINATING ANY IRREGULAR JUMPING OR JERKING OF THE SWEEP SECOND HAND

The sweep second hand in a chronograph should move with a regular even motion, with no irregular jumping or jerking. If the sweep second hand moves with an irregular jumping or jerking motion, this condition should not go uncorrected, as the correct movement of the sweep second hand is all important in regards to the accuracy of a registration. Any irregular movement of the sweep second hand in a chronograph is usually caused by the backlash in the teeth of the seconds wheel with the intermediary wheel, and the backlash in the teeth of the intermediary wheel with the wheel-over-fourth-wheel. Many watchmakers, as they observe the jumping and jerking of the sweep second hand, try to correct this condition by setting the adjustable meshes of the chronograph wheels deeper, thus eliminating any lost motion between the teeth of these wheels, preventing any backlash. This is not the proper way to proceed, as these meshes should have certain safety clearances. If these meshes are set so deep that the irregular jumping of the sweep second hand disappears, then the slightest burr on a tooth, or a piece of foreign matter wedged between the teeth will stop the chronograph.

To eliminate any backlash in the teeth of these wheels, and thus eliminate any irregular movement of the sweep second hand, the chronograph is fitted with a seconds wheel tension spring. The seconds wheel tension spring is shown as "A" in Illustration 97. This tension spring should hold a tension on the seconds wheel to eliminate any backlash in the teeth of the wheels. If the seconds wheel tension spring does not serve this purpose, it is not holding enough tension on the seconds wheel. Thus, the tension must be increased. This is done by bending the seconds wheel tension spring upward, so that when the seconds wheel is replaced, this tension spring will hold a greater tension on the seconds wheel. When adding tension to the seconds wheel tension spring, we must be extremely cautious that no unnecessary tension is added, as this will increase the drag on the train of the watch when the chronograph is registering.

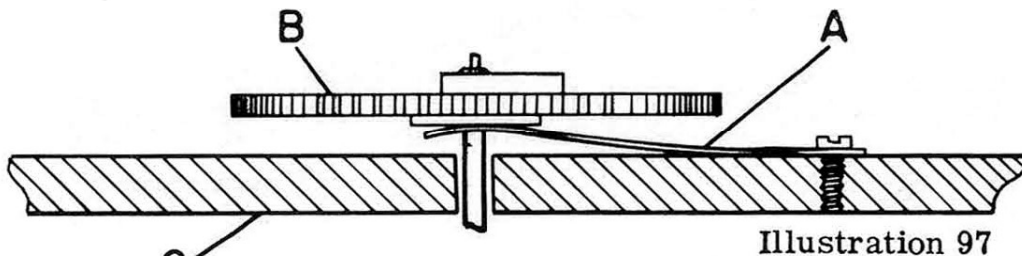

A - Seconds wheel tension spring

B - Seconds wheel

C - Plate

To set the proper tension on the seconds wheel, it is advisable that the repairman proceed as follows, in order that no unnecessary tension is added.

Place a screwdriver under the tension spring, very close to the base. Now by turning the screwdriver slightly, it will cause the tension spring to bend upward. Bend this spring upward little by little, each time observing the progress of the sweep second hand. As soon as sufficient tension has been added to eliminate any irregular moving of the sweep second hand, the tension spring is adjusted to hold its proper tension on the seconds wheel.

After the tension is set correctly on the seconds wheel, it would be worth while for the repairman to make the following test. Take a fine broach and place the point of the broach on the top of the seconds wheel. Now with the broach, force the seconds wheel to move downward against the tension of the seconds wheel tension spring. By doing this, it can be felt just how much tension the seconds wheel tension spring is holding on the seconds wheel. After the repairman has made this test several times, he will acquire a feel that will enable him, by merely pushing down the seconds wheel with a broach, to determine approximately if the tension spring is holding its proper tension on the seconds wheel.

To increase the tension of the spring, the spring need not be disassembled. It is simply bent upwards, close to the base of the spring, as previously explained. For decreasing the tension of the spring, the spring must usually be removed in order to be bent downwards.

Illustration 98 gives a general idea of how much the tension spring should be bent upwards in order that the tension spring will hold the proper tension on the seconds wheel when this wheel is replaced. The dotted line shows the position the tension spring "A" will hold when the seconds wheel is replaced. It can be seen in this Illustration that the tension spring will move down about 10 degrees.

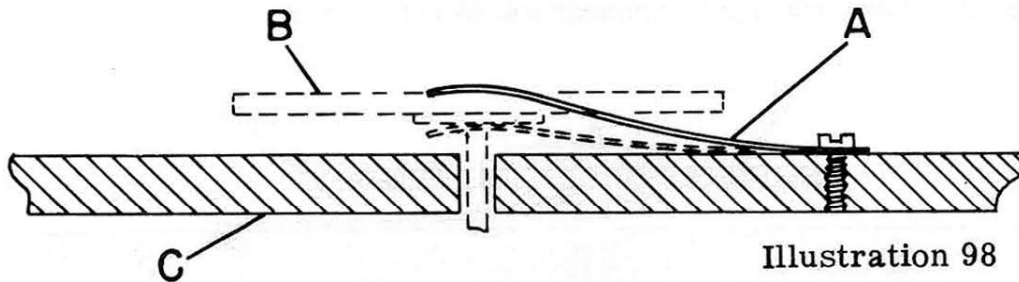

Illustration 98

A - Seconds wheel tension spring

B - Seconds wheel

C - Plate

## SETTING THE TENSION OF THE SECONDS WHEEL TENSION SPRING IN A CHRONOGRAPH THAT HAS NO BRAKE LEVER

In the type of chronograph shown in Volumes 1 and 3, there is no brake lever. Thus, when the registration of the chronograph is stopped, there is no lever to hold the seconds wheel stationary.

In this type of chronograph, the seconds wheel tension spring must serve two purposes.

1. It should prevent any irregular jumping or jerking of the sweep second hand.
2. It should serve to some extent as a brake lever to hold the seconds wheel stationary when the chronograph registration is stopped.

In this type of chronograph, the seconds wheel tension spring, in order to serve as a brake lever, must hold a greater tension on the seconds wheel than in other chronographs. Of course, the tension should not be so great that the chronograph when engaged, would not run at least 24 hours.

It can be easily seen at this point, that there is a definite disadvantage in the chronograph that has no brake lever. The reason being that in this type of chronograph, since the seconds wheel tension spring must hold a greater tension on the seconds wheel, there is an increased drag on the train of the watch when the chronograph is registering. Also, it might be worth while to mention here, that even with the increased tension of the seconds wheel tension spring, this spring will not perform the function of a brake lever as well as a brake lever itself.

Usually, even with the tension on the seconds wheel set stronger, which helps the condition considerably, a jar will still turn the seconds wheel when the chronograph is not registering.

## CHECKING THE DRAG ON THE TRAIN OF THE WATCH CAUSED BY THE SECONDS WHEEL TENSION SPRING AND THE MINUTE REGISTER PAWL

To check the drag on the train of the watch which is caused by the seconds wheel tension spring and the minute register pawl, we should start by leaving down the power of the mainspring. When the power is completely released, wind the mainspring one revolution of the ratchet wheel. Now compare the motion of the balance wheel with the chronograph engaged, to the motion of the balance wheel with the chronograph disengaged. If the motion of the balance wheel decreases noticeably when the chronograph is engaged, this indicates in most cases that the seconds wheel tension spring is holding too great a tension on the seconds wheel. Thus, the tension must be decreased, as explained on pages 82 and 83.

Now the chronograph mechanism should be engaged again to see that the minute registration will be completed without the motion of the balance decreasing noticeably. If the motion of the balance decreases noticeably as the dart tooth turns the intermittent wheel, then more than likely, the minute register pawl is holding too great a tension on the minute register wheel. Thus, the tension must be decreased, as explained on pages 70 and 71.

In addition, this check to determine the drag on the train of the watch is very necessary, as it gives a good indication whether the chronograph will or will not run engaged for at least 24 hours.



## PART 9

### OSCILLATING PINION CHRONOGRAPH

#### ENGAGING AND DISENGAGING OF THE OSCILLATING PINION

In Illustration 99, we show the part in the oscillating pinion chronograph that is called the oscillating pinion. This oscillating pinion consists of a pinion "A", and a brass collar with fine teeth on it, "B". The pinion "A", as shown in Illustration 100, meshes into the teeth of the fourth wheel "D". The collar "B" which is frictioned on the pinion "A", engages and disengages with the seconds wheel to start and stop the chronograph registration. For the collar "B" to engage with the seconds wheel, the oscillating pinion must tilt towards the seconds wheel. See Illustration 100. For the collar "B" to disengage from the seconds wheel, the oscillating pinion must tilt in the direction away from the seconds wheel. See Illustration 101.

In an oscillating pinion chronograph, the oscillating pinion, when engaged with or disengaged from the seconds wheel, should tilt the same degree from a perpendicular position. See Illustration 100 and 101. This same degree tilt of the oscillating pinion makes it possible to have the smallest diameter pivot holes for the pinion, and yet not have the pinion bind as it tilts to engage and disengage.

#### ERROR IN THE REGISTRATION CREATED WHEN THE CHRONOGRAPH IS ENGAGED

When the oscillating pinion engages with the seconds wheel, there can be a slight error created in the chronograph registration. At this point, it would be interesting to observe the engaging of the oscillating pinion with the seconds wheel and see how this error in the registration can occur.

In Illustration 102, we show an enlarged view of the teeth of the oscillating pinion and the seconds wheel. The oscillating pinion is at a position just before it completely engages with the seconds wheel. Observe in this Illustration that the tooth "E" of the pinion is in contact with the tooth "F" of the seconds wheel. It can be seen that for the oscillating pinion to engage deeper with the seconds wheel, it must turn the seconds wheel slightly counter-clockwise. Naturally, any such turning of the seconds wheel will cause the sweep second hand to move. Thus, a slight error in the registration will be the result.

A reverse condition is shown in Illustration 103. The tooth "E" of the oscillating pinion is on the opposite side of the tooth "F" of the seconds wheel. Thus, as the oscillating pinion meshes deeper with the seconds wheel, it must turn the seconds wheel slightly clockwise. The fact that the oscillating pinion, when engaging with the seconds wheel, can cause the seconds wheel to turn slightly clockwise or counter-clockwise, shows that the error in the registration can be either fast or slow. Of course, the engaging of the teeth as shown in Illustrations 102 and 103 are not always the same. Sometimes the teeth may engage without causing any error in the registration. Sometimes this error is less, sometimes it is more, depending entirely on where the teeth of the oscillating pinion contact the teeth of the seconds wheel when engaging.

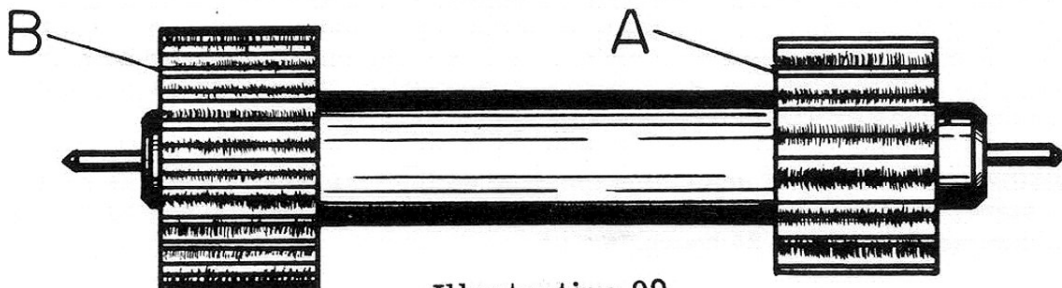

Illustration 99



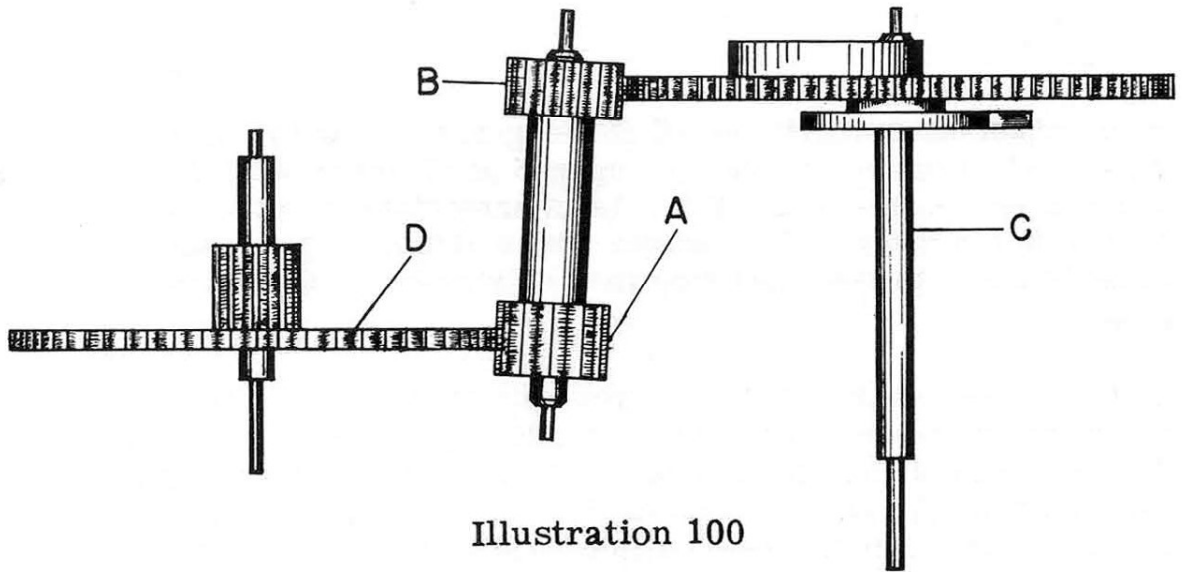

Illustration 100

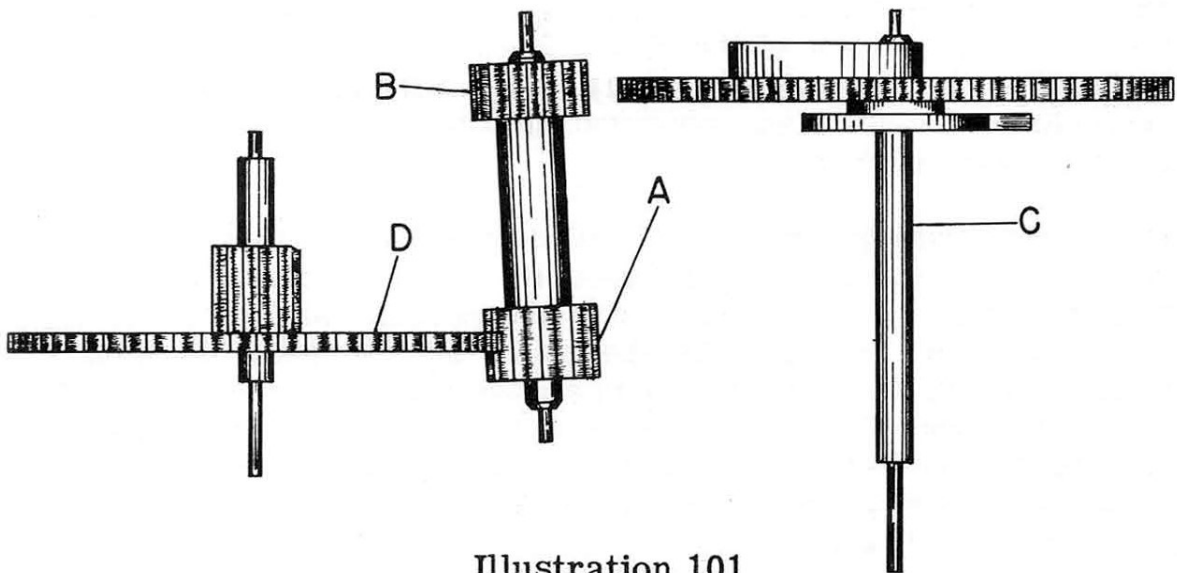

Illustration 101

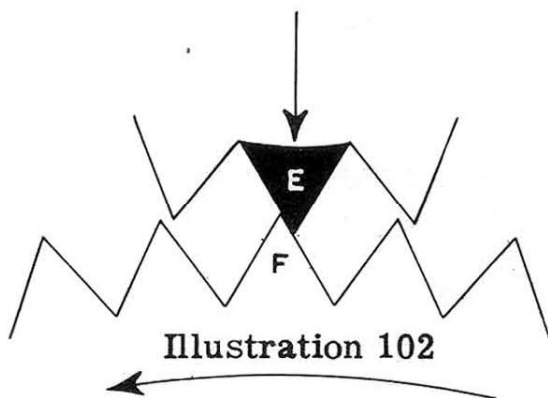

Illustration 102

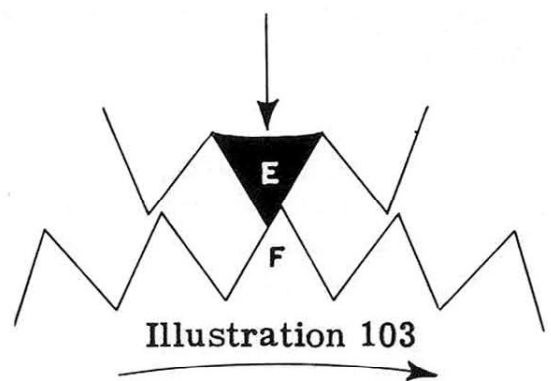

Illustration 103

A - Pinion  
B - Brass collar

C - Seconds wheel  
D - Fourth wheel

In the wheel over fourth wheel chronograph, a similar error in the registration can be caused as the chronograph is engaged.

In the wheel-over-fourth-wheel chronograph, the intermediary wheel "A", Illustration 104, is engaged at all times with the wheel-over-fourth-wheel "B". The intermediary wheel which is pivoted in the detent "E" engages with and disengages from the seconds wheel to start and stop the registration of the chronograph.

As the intermediary wheel engages with the seconds wheel, the intermediary wheel must rotate slightly clockwise on its axis. This rotation of the intermediary wheel as it moves to engage with the seconds wheel is due to this wheel being engaged with the wheel-over-fourth-wheel, which is stopped. (It must be kept in mind that the wheel over fourth wheel is stopped most of the time, even when the watch is running. This is due to the pallet lever, a large portion of the time being against its bank and the train stopped. Since this is the case, in order to eliminate any confusion, we must in our observation think of the wheel over fourth wheel as stopped.)

In order to show how much the intermediary wheel turns when engaging, we have blackened a tooth of the intermediary wheel when this wheel is disengaged from the seconds wheel. See Illustration 104. We have also blackened the same tooth of the intermediary wheel when this wheel is engaged with the seconds wheel. See Illustration 105. Thus by comparing the position of the blackened tooth "H" before and after the intermediary wheel is engaged it can be seen how much the intermediary wheel rotates as it engages with the seconds wheel.

(In Illustrations 104 and 105, we have added the dotted line "T" to help show the amount the tooth "H" has turned from a disengaged to an engaged position.)

- |                             |                                       |
|-----------------------------|---------------------------------------|
| A - Intermediary wheel      | E - Chronograph pivoted detent        |
| B - Wheel over fourth wheel | F - Chronograph pivoted detent spring |
| C - Seconds wheel           | G - Castle wheel pawl                 |
| D - Castle wheel            |                                       |

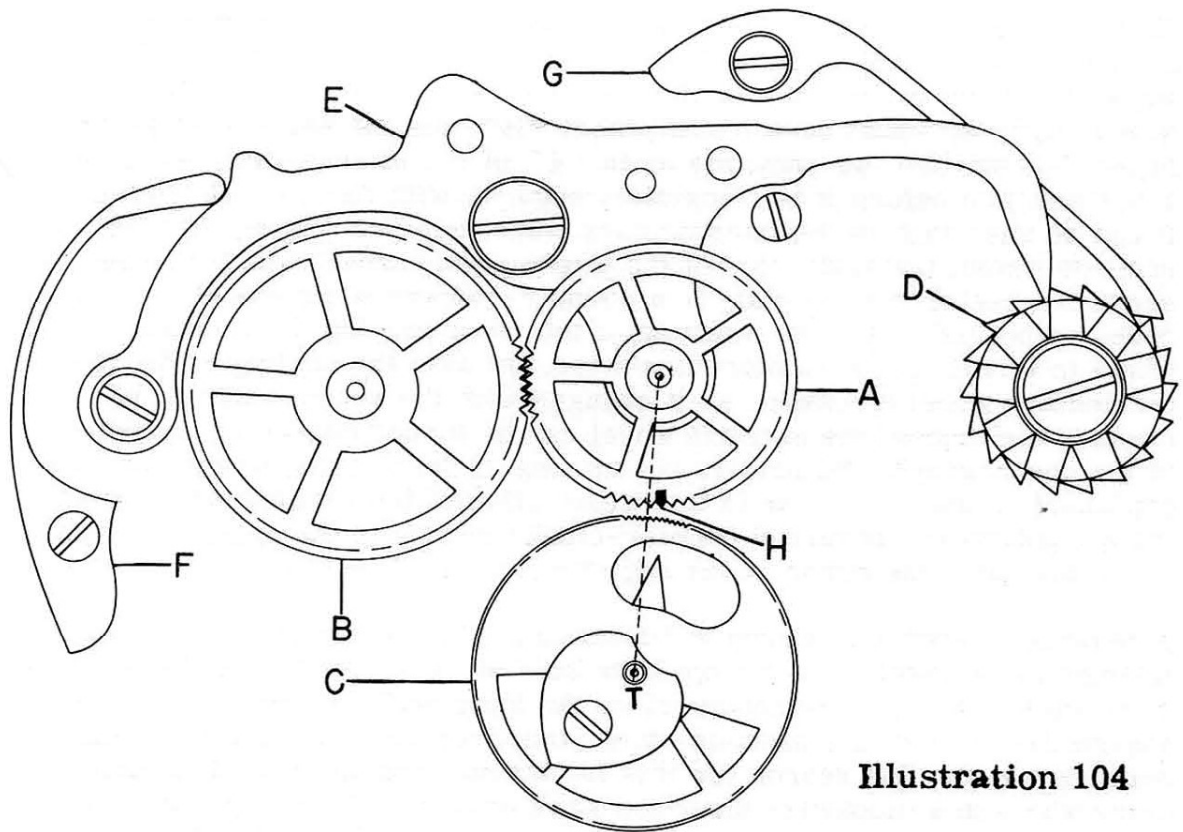

Illustration 104

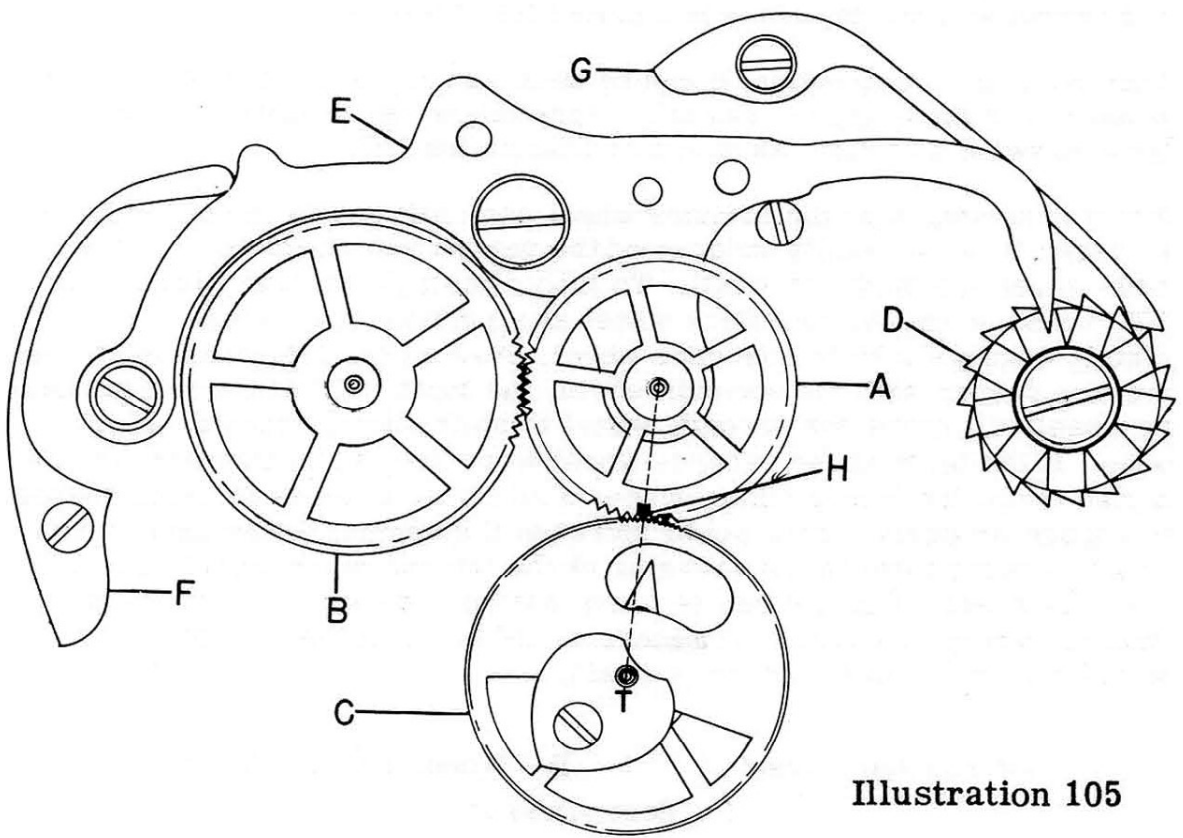

Illustration 105

To illustrate in the wheel over fourth wheel chronograph the error that can occur due to the engaging of the intermediary wheel with the seconds wheel, we show in Illustration 106 a larger view of the intermediary wheel "A", the wheel over fourth wheel "B", and the seconds wheel "C". In this Illustration, we show the tooth "E" of the intermediary wheel at a position just before it is completely engaged with the seconds wheel. It can be seen that as the intermediary wheel meshes deeper with the seconds wheel, the tooth "E" of the intermediary wheel will force the seconds wheel to turn slightly in a counter-clockwise direction. In this case, we not only have the meshing of the teeth causing the seconds wheel to turn slightly counter-clockwise, but also the turning of the intermediary wheel clockwise as it engages with the seconds wheel, increases the amount the seconds wheel can be turned due to the engaging of the chronograph. Naturally, any turning of the seconds wheel, such as explained, causes an error in the registration of the chronograph. When the seconds wheel is turned counter-clockwise due to the engaging, such as in this case, the error in the registration would be fast.

A reverse condition is shown in Illustration 107. The tooth "E" of the intermediary wheel is on the opposite side of the tooth "F" of the seconds wheel. In this case however, as the intermediary wheel moves to engage deeper with the seconds wheel, there would be no turning of the seconds wheel. The reason for this is that the turning of the intermediary wheel in a clockwise direction when engaging deeper with the seconds wheel makes it possible for the tooth "E" of the intermediary wheel to clear the tooth "F" of the seconds wheel. Therefore, the seconds wheel will not be turned in a clockwise direction.

Thus from this observation, it can be seen that any turning of the seconds wheel due to the engaging, can only cause this wheel to move in a counter-clockwise direction, as shown in Illustration 107.

From observing how the seconds wheel can shift due to the engaging of the teeth, it can be easily understood the reason why the teeth of the seconds wheel are made so small. To fully illustrate this, in Illustration 108, we show the intermediary wheel at a position just before it completely engages with the seconds wheel. Now as the intermediary wheel meshes deeper with the seconds wheel, the tooth "E" of the intermediary wheel will cause the seconds wheel to shift slightly counter-clockwise. If the teeth of the seconds wheel were larger, as indicated by the dotted teeth, the intermediary wheel would have to move in much deeper to engage properly. This would increase the amount the seconds wheel could be turned due to the engaging of the intermediary wheel with the seconds wheel. Thus, it can be seen that the smaller the teeth of the seconds wheel, the less error there would be when the intermediary wheel engages with the seconds wheel.

A - Intermediary wheel

B - Wheel over fourth wheel

C - Seconds wheel



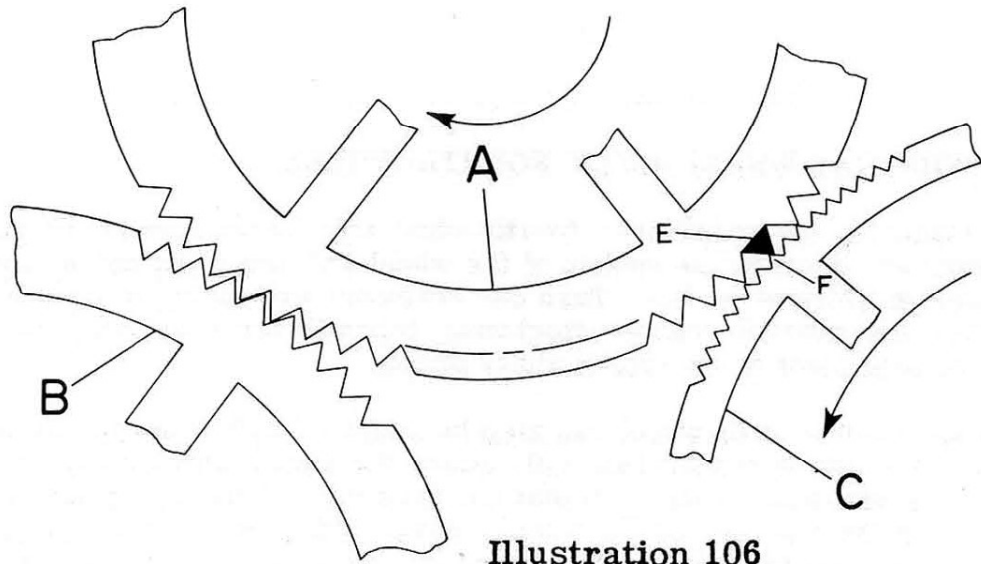

Illustration 106

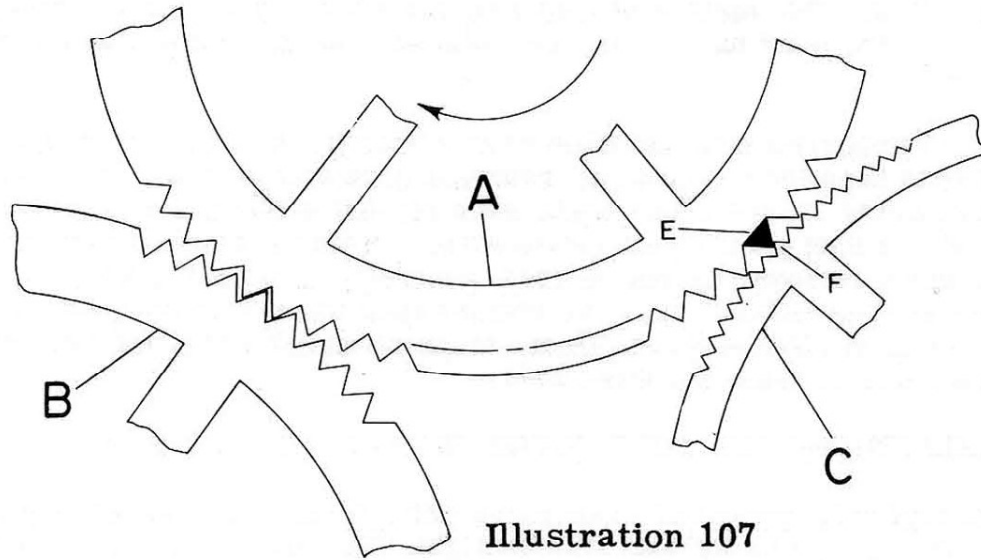

Illustration 107

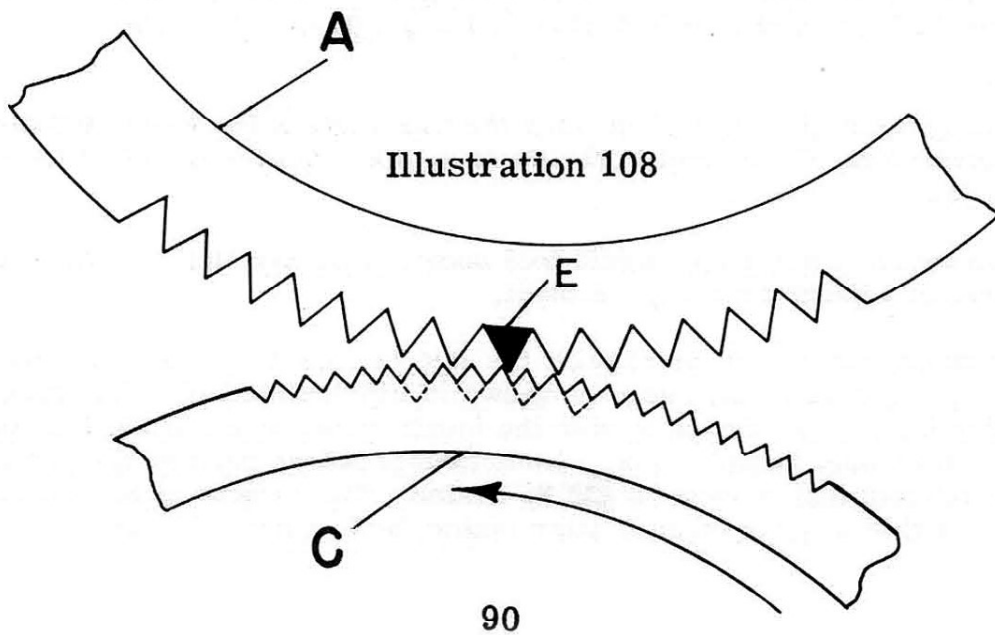

Illustration 108

## PART 10

### CHRONOGRAPHS WHEELS AND GEARING

#### REMOVING THE WHEEL-OVER-FOURTH-WHEEL

When removing the wheel-over-fourth-wheel with screwdrivers, place the screwdrivers between the spokes of the wheel and under the hub of the wheel as shown in Illustration 109. Turn one screwdriver clockwise while turning the other screwdriver counter-clockwise; this will force the wheel up free from the long pivot of the fourth wheel pinion.

The wheel-over-fourth-wheel can also be removed with a sweep wheel remover, as shown in Illustration 110. Place the sweep wheel remover over the wheel-over-fourth-wheel so that the jaws "A" of the sweep wheel remover grip the hub "B" on the wheel. Press sides "D" of the sweep wheel remover, forcing the jaws "A" to move up, pulling the wheel-over-fourth-wheel with it. This method of removing the wheel-over-fourth-wheel is considered the least hazardous, lessening the chance of marring the plate or wheel.

The most important consideration when removing the wheel-over-fourth-wheel is to keep the sweep wheel remover perfectly upright. If the sweep wheel remover is on a slight angle when removing this wheel, it may bend or break the long pivot on the fourth wheel. Under certain conditions, the sweep wheel remover cannot be used, generally because the wheel-over-fourth-wheel is difficult to get at with a sweep wheel remover, or the bridge is too small to offer support. Under these circumstances, use two small screwdrivers in removing this wheel.

#### STRAIGHTENING THE LONG PIVOT ON THE FOURTH WHEEL

Before replacing the wheel-over-fourth-wheel, the fourth wheel long pivot should be checked to see that it is straight. This can be done by viewing the fourth wheel long pivot with a loupe while the train is spinning. Any amount the long pivot is bent that calls for a correction will be easily noticed.

To straighten such a bent pivot, take the wheel out of the watch, because any corrections of the pivot in the watch would endanger the pivot as well as the jewels.

I would advise making the simple tool shown in Illustration 111, to obtain a good result without breaking the pivot.

When straightening the pivot with the use of this tool, the fourth wheel should be chucked in the lathe, as shown in Illustration 112. This makes it possible for the repairman to spin the fourth wheel to see if the long pivot is true after each bend is made. Immediately before bending the pivot, the end of the tool that is used should be heated. The bending should be performed within about 5 seconds after taking the tool out of the flame.

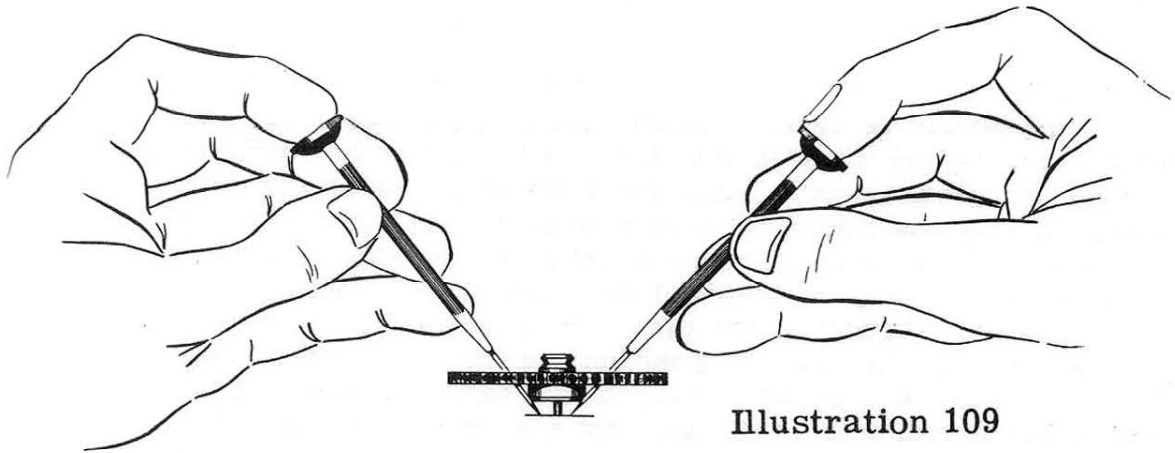

**SWEEP WHEEL REMOVER**

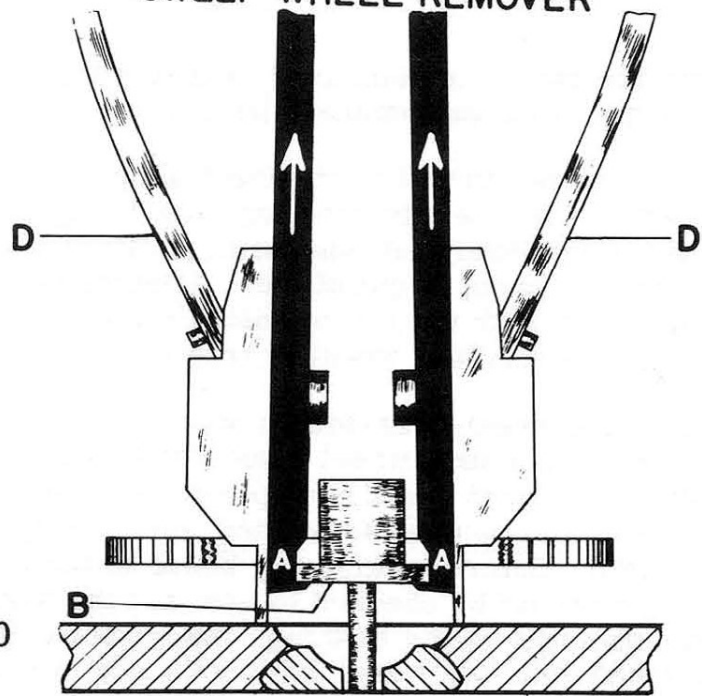
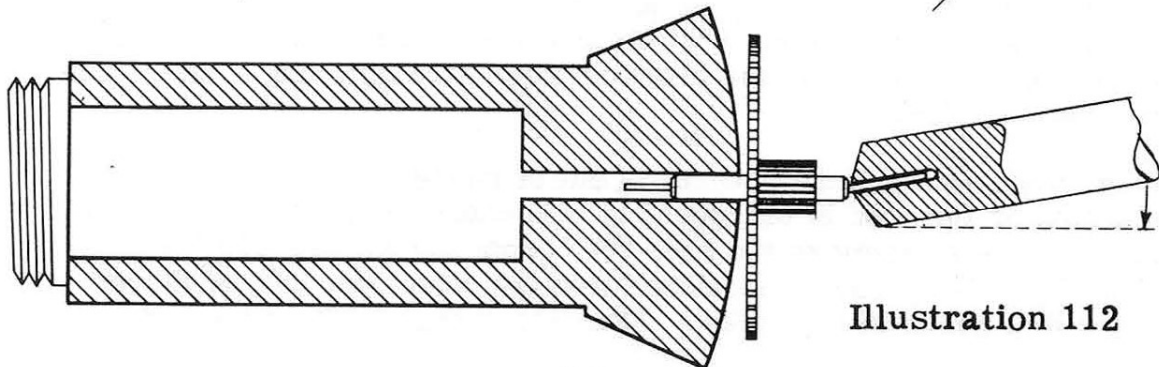
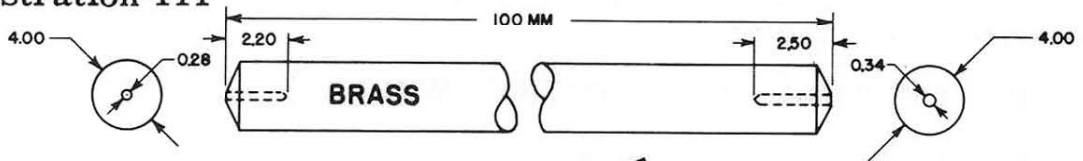

Illustration 111



## TRUING THE WHEEL-OVER-FOURTH-WHEEL IN THE FLAT

When replacing the wheel-over-fourth-wheel in the chronograph, this wheel should be checked to see that it spins true in the flat. When checking this wheel to see that it is true, it is advisable to remove the escapement, so that the train of the watch can spin freely. If this wheel does not spin true in the flat, many times it can be made to do so by turning this wheel on the long pivot of the fourth wheel. In other words, hold the fourth wheel stationary and turn the wheel slightly on the pivot. In most cases, by merely shifting the wheel to different positions on the fourth wheel long pivot, this wheel will become true. If this has been done and the wheel-over-fourth-wheel still does not spin true in the flat, the wheel-over-fourth-wheel itself is more than likely bent, causing the wheel to be out of true.

There are many methods used in truing the wheel-over-fourth-wheel, but most watchmakers prefer to use the following.

Turn the wheel-over-fourth-wheel slowly, and observe the level of this wheel with the intermediary wheel. By observing these two wheels while slowly turning them, it can be seen where the wheel-over-fourth-wheel is out of true. (Before checking the wheel-over-fourth-wheel with the intermediary wheel, we must first be sure that the intermediary wheel is true.)

To bend the wheel-over-fourth-wheel, it must be removed each time from the fourth wheel pivot. This eliminates the danger of bending the fourth wheel long pivot. To bend the wheel, the same method should be used as is used when straightening train wheels in a watch. Before making any bends in the wheel-over-fourth-wheel, it should be checked to see that the wheel is all the way down on the shoulder of the bushing. Many times, the bushing which is frictioned into the wheel is on an angle in the wheel, causing the wheel to appear out of true in the flat. Of course, if this is the case, the correction would be to stake the wheel down flush on the shoulder of the bushing.

## TRUING THE WHEEL-OVER-FOURTH-WHEEL IN THE ROUND

To begin with, the best way to deal with a chronograph wheel that is out of round is to replace it with a new one. In the case where the wheel is not obtainable, the procedure for straightening a wheel can be used as follows.

If the wheel-over-fourth-wheel is out of round because the hole in the tube or the hole in the wheel is off center, the correction would be as follows. Remove the tube "A" from the wheel. See Illustration 113. (This tube is frictioned into the wheel and can be driven out with a punch in the stake.) Then place the wheel on a mandrill



Illustration 113

and place the mandrill in the truing calipers as shown in Illustration 114. (Dimensions for making a mandrill that will fit in the hole of most wheel-over-fourth-wheels, is shown in Illustration 115.

Now check the wheel to see that it is true in the round. If the wheel is found true, then the hole in the tube is off center. In this case, all that is necessary is to make a new tube with a correctly centered hole and replace it in the wheel-over-fourth-wheel.

If the wheel is not true when checked after the tube is removed, then proceed as shown in Illustration 116. Select a round piece of brass that is larger than the wheel, and place the brass rod in the lathe. Then cut a flat recess in the brass so that the wheel fits snug in the recess without sideshake. Now shellac the wheel in the recess, and with a graver, cut the hole in the wheel true. Remove the wheel from the brass and make a new tube for the hole in the wheel.

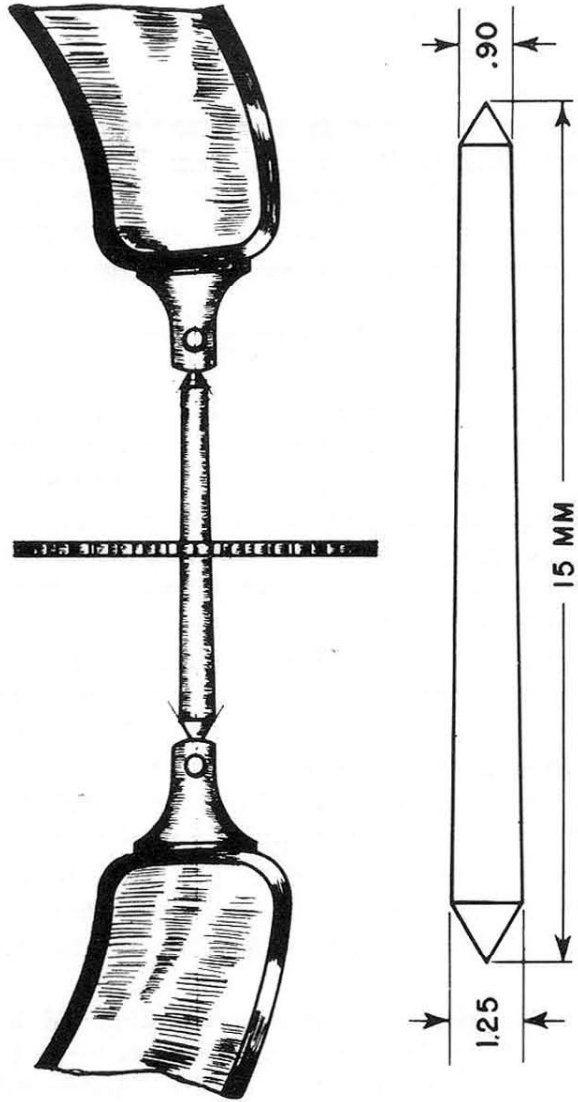

Illustration 114 Illustration 115

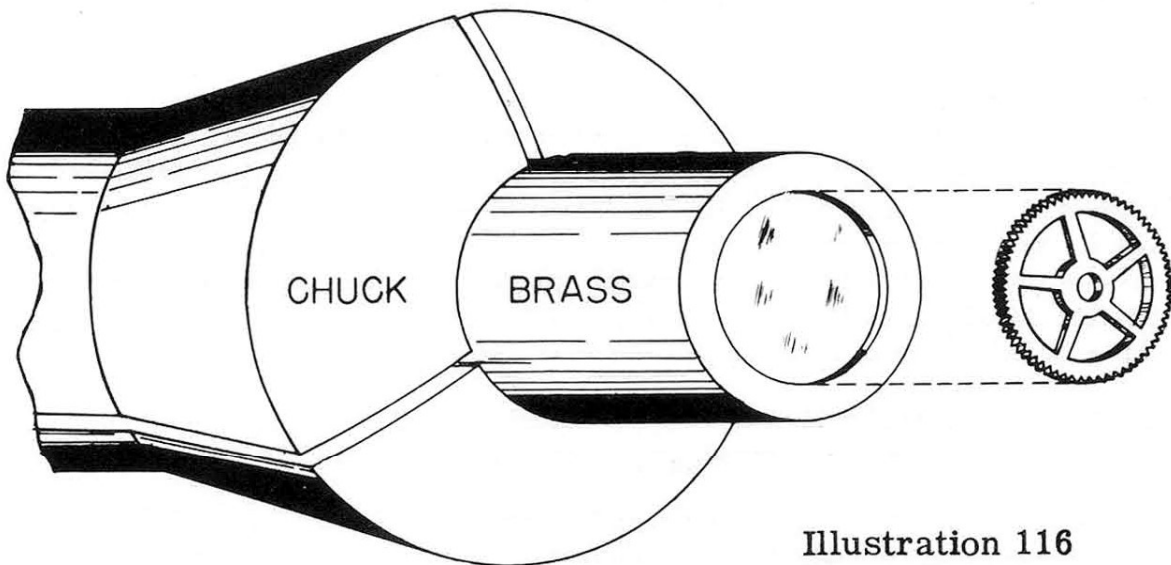

Illustration 116



If the wheel is out of round because it is flattened between two arms, as shown in Illustration 117, the correction can be made as follows. Place the wheel on a wood block which is filed as shown in Illustration 118. Observe in this Illustration the curve of the wood is more accentuated than that of the wheel, and that the wheel is supported at the location of the two arms. Now place a burnisher between the arms of the wheel where the wheel is bent, and rub the burnisher in the direction of the arrows until this section of the wheel is true.

#### SETTING THE PROPER DEPTH OF THE CHRONOGRAPH WHEELS

In most chronographs, the depth of the wheel-over-fourth-wheel with the intermediary wheel, and the intermediary wheel with the seconds wheel is controlled by eccentric studs. When repairing chronographs, many times, you will find the depth of these wheels is not set correctly, and thus must be corrected by adjusting the eccentric studs. In order to give some idea of the proper depth of chronograph wheels, we show in Illustration 119 an enlarged view of the wheel-over-fourth-wheel "B" properly depthed with the intermediary wheel "A", and the intermediary wheel "A" properly depthed with the seconds wheel "C".

When setting the depth of the wheel-over-fourth-wheel with the intermediary wheel, we must be careful that this depth is not set too deep. The wheel-over-fourth-wheel and the intermediary wheel have VEE type teeth, and because of this, if the depth of these wheels is set too deep, there would be no clearance between the teeth. Thus, the smallest piece of foreign matter would stop the chronograph.

Of all the depthing of the different wheels in the chronograph, the depthing of the intermediary wheel with the seconds wheel is the most delicate. If the depth is set too deep, the slightest burr on the teeth, or the smallest piece of dirt wedged between the teeth of the seconds wheel may cause the watch to stop. On the other hand, if the depth is set too shallow, the desired accuracy is lost.

In Illustration 120, we show the wheel-over-fourth-wheel with epicycloidal teeth depthed properly with the intermediary wheel that has VEE type teeth. Epicycloidal teeth meshed with VEE type teeth, although it is not as popular as the meshing of two wheels with VEE type teeth, has a slight advantage in that the points of the teeth do not mesh so deeply. This leaves a clearance so that a small piece of foreign matter would pass through the teeth without causing the watch to stop. Also in this type of gearing, there is a reduced backlash.

In the chronographs illustrated in Volumes 1, 3, 4, 5, 7, 9, 10, 12, 13, 17, 21, 22, and 26, the wheel-over-fourth-wheel has VEE type teeth.

In the chronographs illustrated in Volumes 8, 11, 14, 18, and 20, the wheel-over-fourth-wheel has epicycloid teeth.

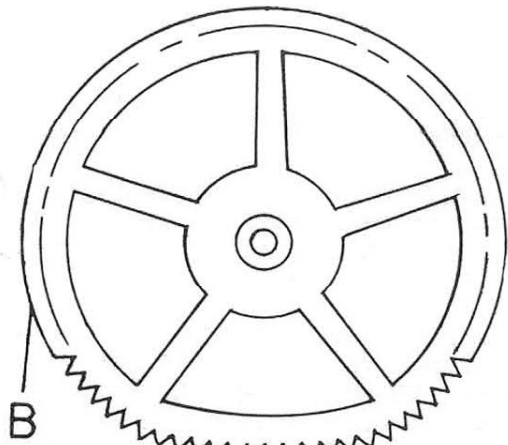

Illustration 117

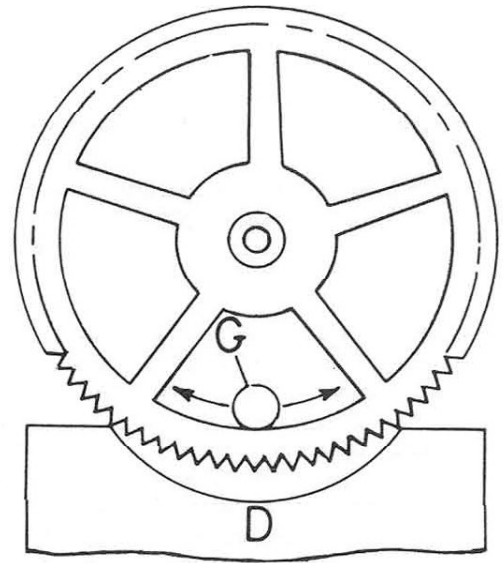

Illustration 118

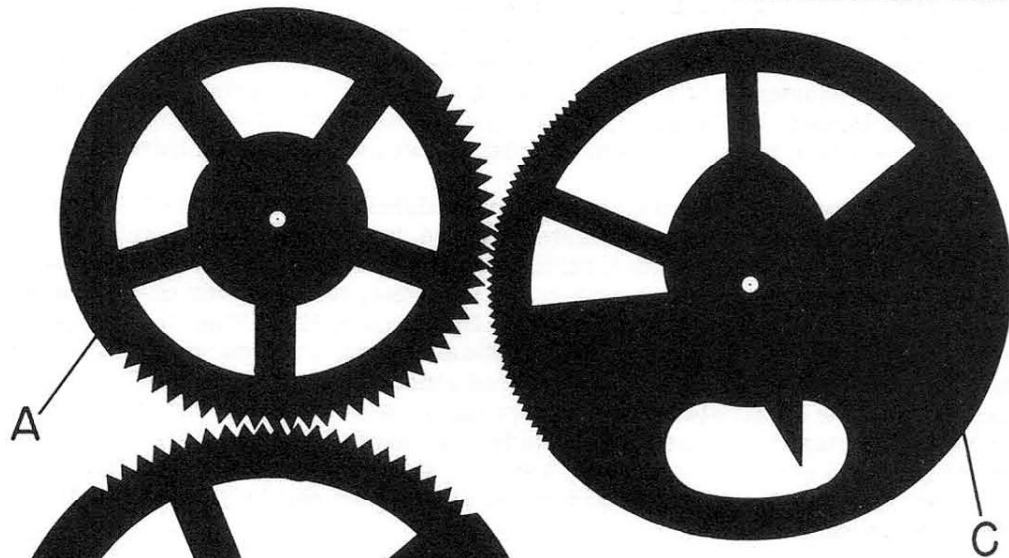

Illustration 119

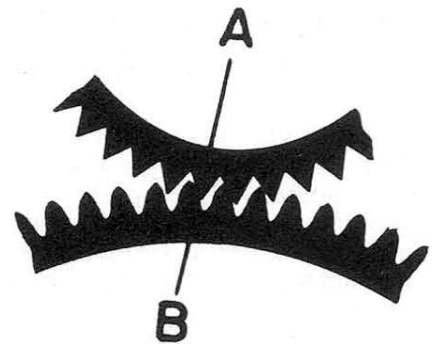
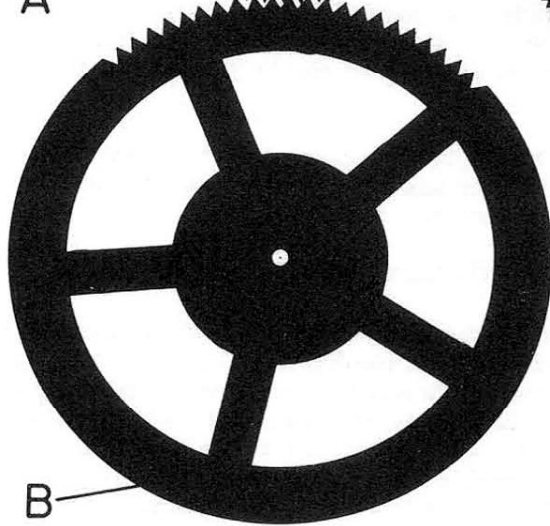

Illustration 120

- A - Intermediary wheel
- B - Wheel-over-fourth-wheel
- G - Burnisher

- C - Seconds wheel
- D - Wood block

## PART 11

### SHOULDERED SCREWS

#### SHORTENING OR LENGTHENING THE SHOULDER OF A SCREW

In the chronograph mechanism, generally speaking, there are more shouldered screws used than any other type of screw. These shouldered screws are used for wheels and detents to pivot on, for holding down certain parts so they cannot ride up, for holding wire springs in place, etc.

In chronograph repairing, you will find shouldered screws many times need retouching if a part has too little or too much endshake. When a part has too much endshake, due to the shoulder of the screw being too long, as shown in Illustration 121, the correction will be made by shortening the shoulder of the screw. To shorten the shoulder of a screw, an undercutter can be used, as shown in Illustration 122. Place the threaded part of the screw in a hole in the undercutter. The threaded part of the screw should fit in the hole in the undercutter with very little side play. The screw is then turned under light pressure of the screwdriver "A" until sufficient metal has been removed to shorten the shoulder of the screw the desired amount.

If the shoulder of a screw needed to be shortened a large amount, the use of the undercutter would produce a shouldered screw that resembles the screw shown in Illustration 123. Observe that the surface "B" of the shouldered screw which remained after the shoulder was shortened has not threads on it, and if this surface is not threaded, it may ruin the threads in the plate. Thus, the section "B" of the screw should be threaded in order that the screw, when replaced, will not harm the threads in the plate.

If the reverse is the case, and the part has no endshake due to the shoulder of the screw being too short, as shown in Illustration 124, the head of the shouldered screw, if it is thick enough, can be cut back with the use of the undercutter. To cut back the head of the shouldered screw to lengthen the shoulder, the shoulder of the screw should fit neatly in the hole of the undercutter. See Illustration 125. Then the screw is turned under pressure with a screwdriver until sufficient metal is removed from the head to lengthen the shoulder of the screw the desired amount. This method of lengthening the shoulder of a screw is satisfactory if a part does not work under the head of the shouldered screw. If a part is to work freely under the head of a shouldered screw, the underside of the head should be polished, and thus if the shoulder is to be lengthened, it is best to be done in a lathe so the underside of the head can be polished at the same time the head is cut back.

If the head of a shouldered screw cannot be cut back because it is too thin, a washer can be made the same diameter as the shoulder and slipped over the threads of the screw to make the shoulder longer. See Illustration 126.

#### MAKING A SHOULDERED SCREW FROM A REGULAR SCREW

In repairing chronographs, an assortment of shouldered screws is very valuable to have on hand, as many times a shouldered screw is needed to replace one that was lost, broken, or otherwise. However, if the repairman doesn't have an assortment of shouldered screws, but has an assortment of regular screws, he can make a shouldered screw out of a regular screw by making a washer to fit on the screw to serve as a shoulder. See Illustration 127. This method of making a shouldered screw will in some cases make it possible to complete a repair job that would ordinarily be held up for the need of a shouldered screw.

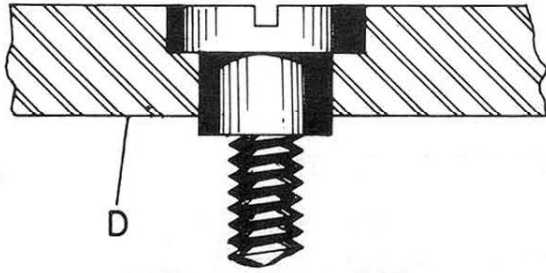

Illustration 121

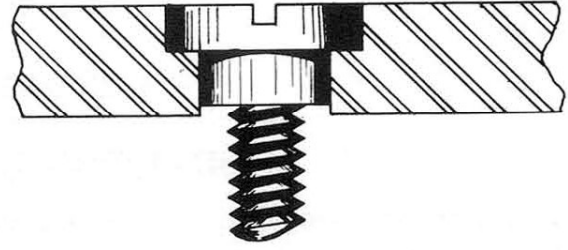

Illustration 124

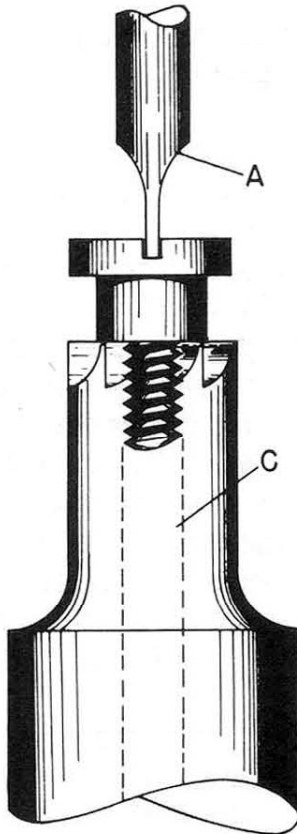

Illustration 122

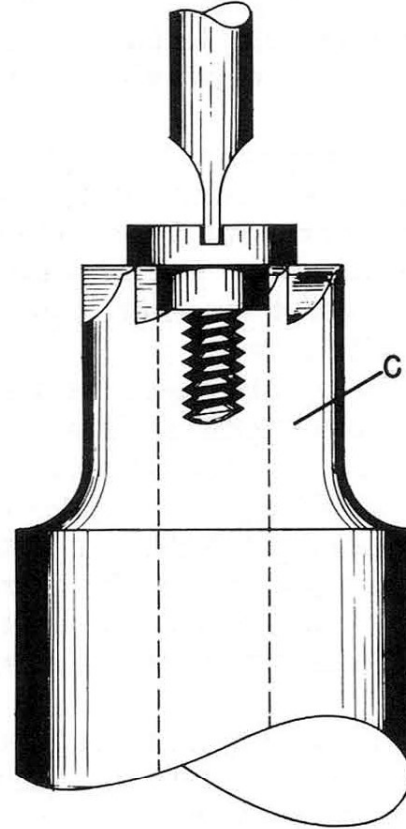

Illustration 125

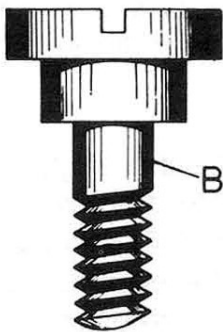

Illustration 123

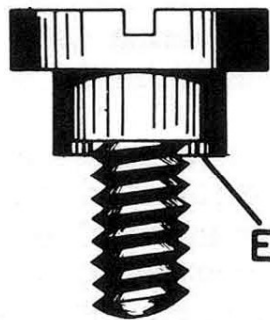

Illustration 126

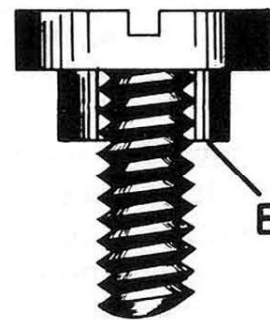

Illustration 127

A - Screwdriver  
C - Undercutter

D - Plate  
E - Washer



## PART 12

### ECCENTRIC STUDS

#### TIGHTENING ECCENTRIC STUDS

Quite often, we find in chronographs, eccentric studs that become loose in the plate by repeated adjusting. In some instances, the studs are loose to such an extent that they change their position as the chronograph is operated, or they even fall out of place. When proceeding to tighten an eccentric stud, we should choose the procedure depending upon the circumstances.

1. Quite popular is the practice of laying the eccentric stud upside down on an anvil, and tapping the end of the stud with a hammer. See Illustration 128. In some instances, this procedure has a harmful effect because if burrs were formed at the end of the post, and such a post is forced into the plate, it will only cut the hole in the plate larger. See Illustration 129. In this case, the result of a tighter stud is not achieved, and the condition is worse than before the correction was made. In some instances however, the above desired procedure of tapping the post of the eccentric stud will give a satisfactory result. This is the case if the post is not longer than wide, and at the same time, the end of the post is rounded. Illustration 130 shows such an eccentric stud. The dotted line indicates the shape of the post after being tapped.
2. In all cases where the post and eccentric stud goes far enough through the plate so that the end of the post reaches the surface on the other side of the plate, or comes close enough to the surface, the following procedure can be used effectively. Hold the plate with the eccentric stud on a suitable anvil in the stake, and tap the end of the post with a small round-nose punch, as shown in Illustration 131. This will spread the post so that it will be tight again in the hole.

If the above two mentioned procedures cannot be employed due to certain circumstances, then there is still another way to make the eccentric stud hold tight in the plate. Instead of spreading the post of the eccentric stud, you can also close the hole in the plate, and then ream it out to a tight fit. The closing of the hole can be done with a hollow taper mouth punch, which gives a much better result than the round nose punch, as you can see in Illustration 132.



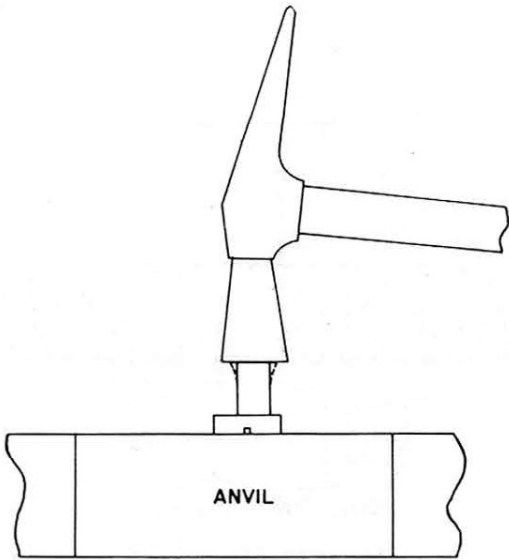

Illustration 128

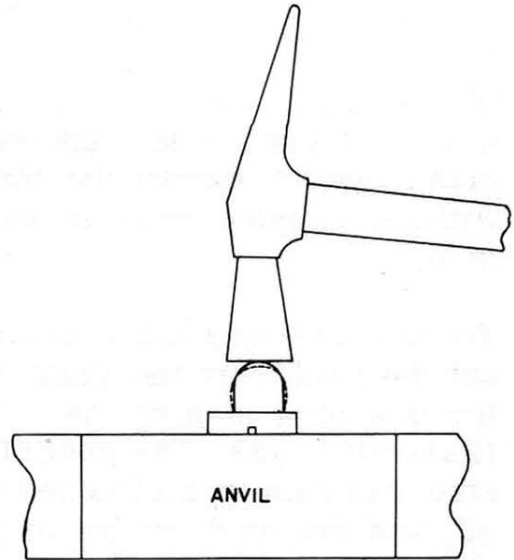

Illustration 130

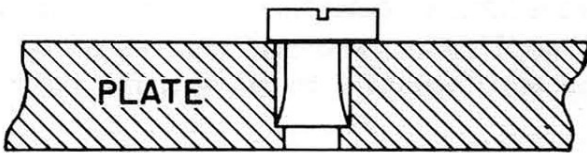

Illustration 129

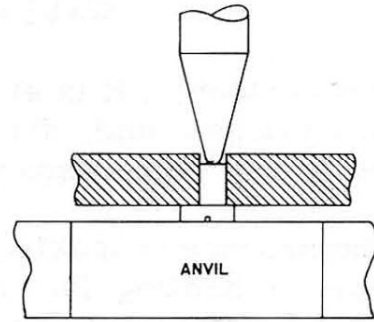
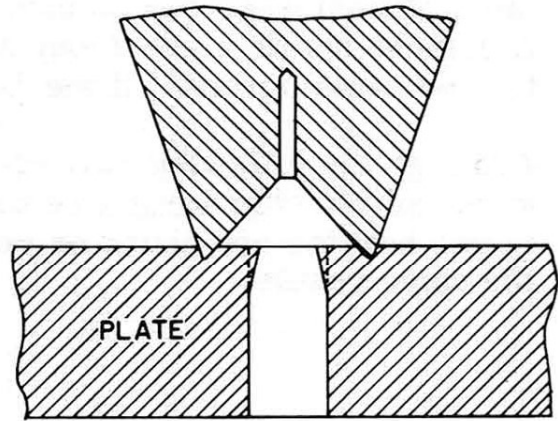
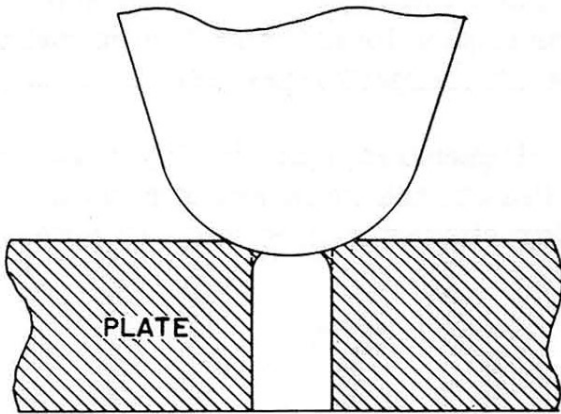

Illustration 131



THIS PORTION WILL HOLD THE POST OF THE ECCENTRIC STUD

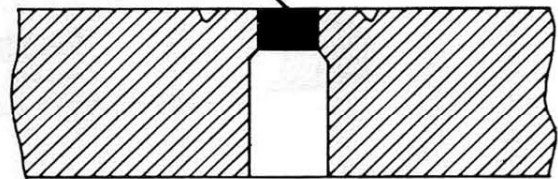
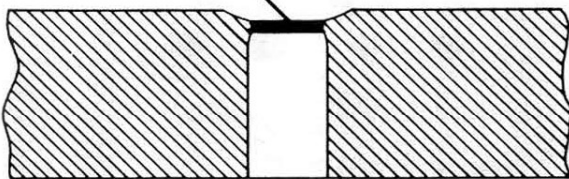

Illustration 132

## LOOSENING ECCENTRIC STUDS

Occasionally, we find an eccentric stud that is so tight in the plate that it cannot be turned without causing damage to the stud.

To correct such a condition, drive out the stud from the plate with the use of a staking set. See Illustration 133. The post of the stud can then be moistened with oil, and the stud driven back in place.

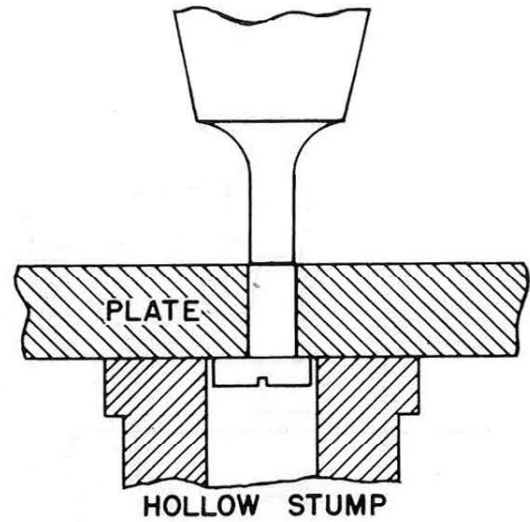

Illustration 133

## MAKING ECCENTRIC STUDS

Due to accidents, it is at times necessary to replace an eccentric stud with a new stud. Since exact duplicates are not always available, it may be necessary for the watchmaker to make a new stud.

In the process of making an eccentric stud, there must be some means of shifting the stock steel off center in the lathe, so that the head of the stud can be turned off center in relation to the post of the stud. The box chuck (shown below) or other similar lathe attachments can be used to shift the stock steel off center. A cement chuck made from an ordinary brass rod can be used for the same purpose, if the lathe attachments are not at hand.

Although the following procedure illustrates a method of making an eccentric stud using a cement chuck, the repairman can easily see how the box chuck or similar chucks can be used to obtain the same results.

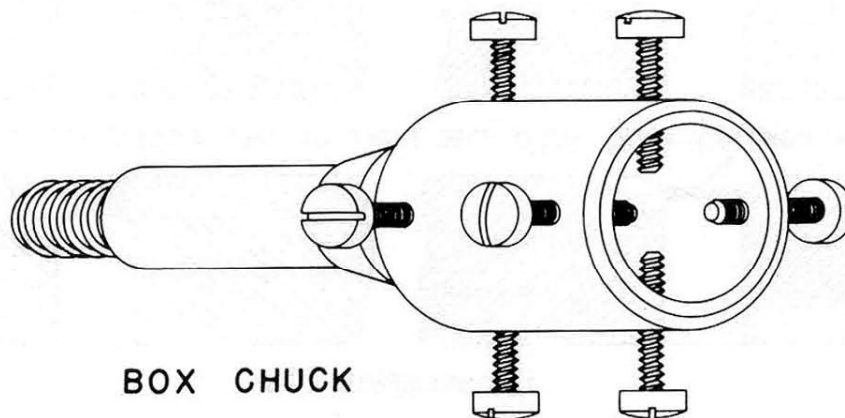

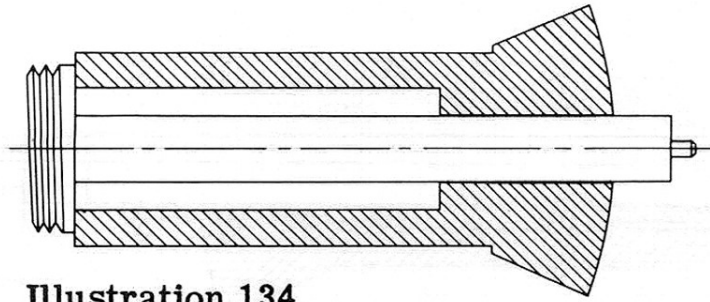

**Illustration 134**

Select a steel rod, 2.8 MM in diameter, and place it into the proper chuck in the lathe. Turn a post on the end of the rod that will fit friction tight into the respective hole for the stud. The length of the post will be determined by the thickness of the plate or part into which the post is to be fitted. The end of the post should be beveled so that it can enter the hole in the plate easier.

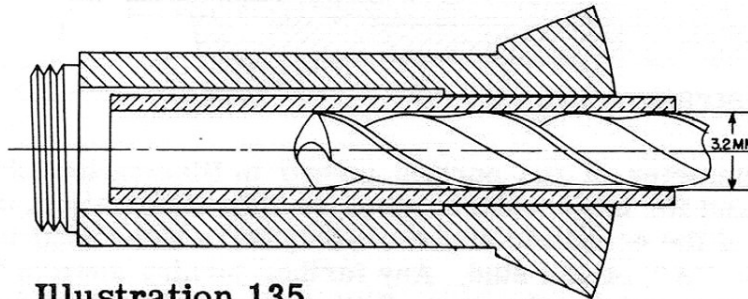

**Illustration 135**

Select a brass rod that fits a No. 50 chuck, and is approximately one and one-half inches in length. Place the brass rod into the chuck. Select a drill that measures 3.2 MM, or 1/8 inch in diameter, and drill a hole through the center of the brass. The brass tube thus made, will serve as the cement chuck.

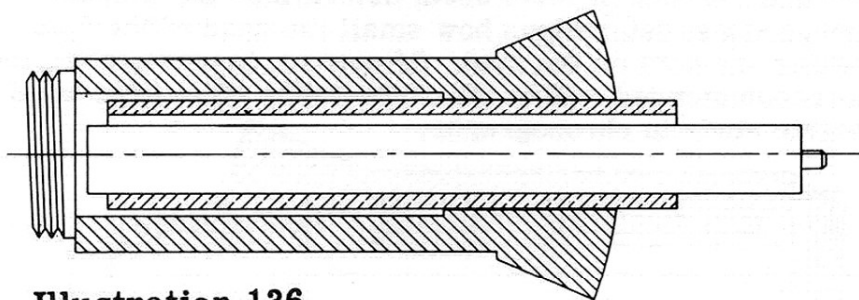

**Illustration 136**

Remove the brass tube from the lathe and shellac the steel rod in the brass tube. The steel rod should be off center in the brass tube to the fullest extent, as shown in this Illustration.

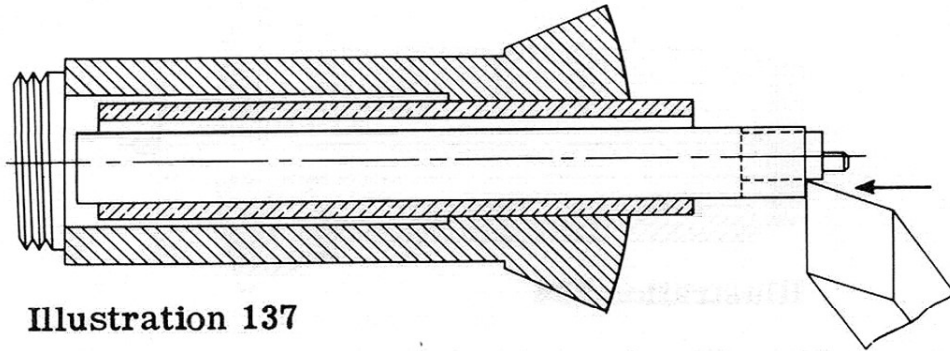

Illustration 137

Turn off the eccentric portion of the steel rod, cutting with a graver in the direction of the arrow.

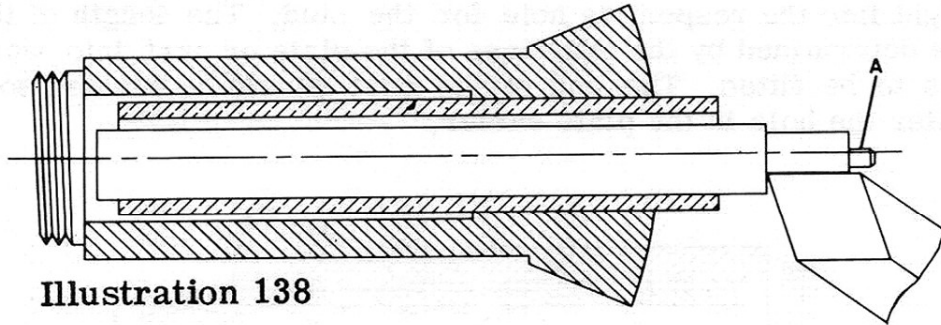

Illustration 138

Reduce the diameter of the portion turned in Illustration 137 to the size of the head desired for the eccentric stud. In this Illustration, it can be seen that the head of the eccentric stud could only be reduced until the graver contacts the post "A" of the stud. Any further turning down of the head would cut away the post, ruining the stud. With the use of 2.8 MM steel, there may be cases where the head of the stud cannot be made small enough before the graver starts cutting the post. If this happens, a larger diameter steel, from .1 to .2 MM larger must be used, so that when the steel is placed in the cement chuck, it will not be as far off center. Thus, the head of the eccentric stud could be made smaller before the graver would contact the post "A". On the other hand, if a larger and more eccentric stud is needed, a smaller piece of steel, from .1 to .2 MM should be used. From this information, it can be seen that the size of steel used, determines the amount the stud will be eccentric, and also determines how small the head of the stud can be made without cutting the post on the stud. Of course, in most cases, the size steel 2.8 MM, as recommended, will be the correct size steel to be used for making most eccentric studs in chronographs.

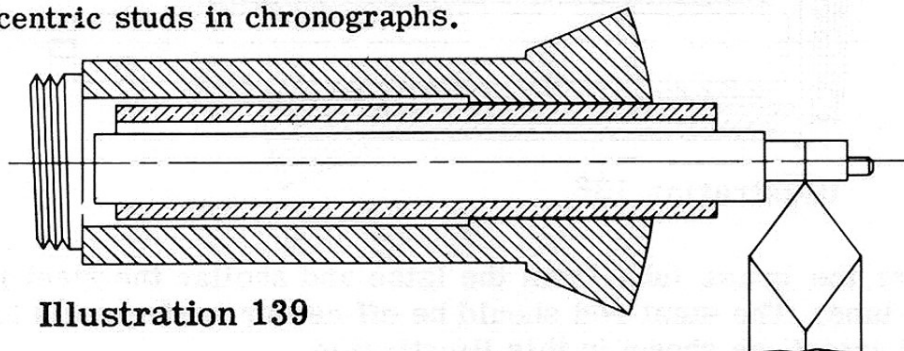
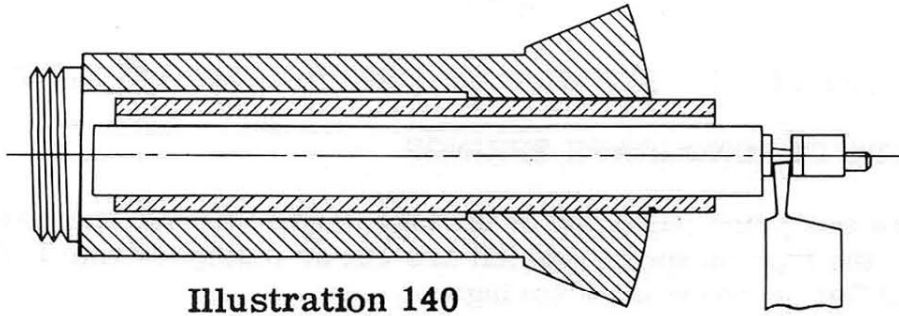

Illustration 139

Mark the correct length of the head of the eccentric stud with the point of a graver.



**Illustration 140**

Cut the eccentric stud off from the steel rod slightly behind the marked length of the stud.

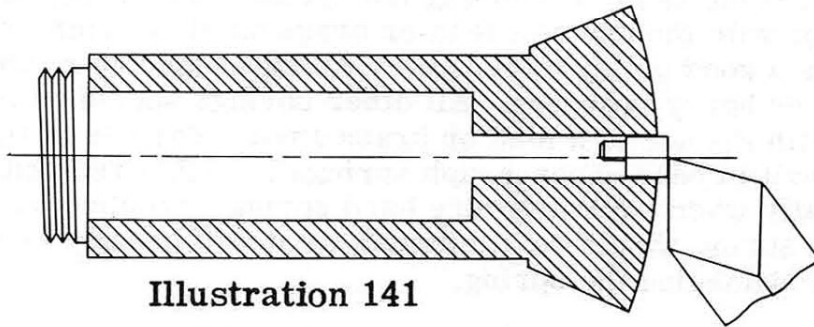

**Illustration 141**

Put the eccentric stud into the proper chuck and turn the head back to the mark that indicates the correct length.

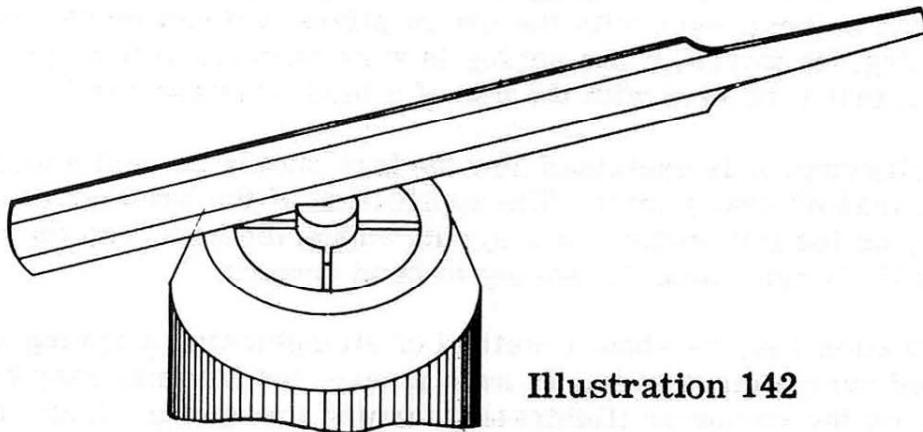

**Illustration 142**

Put the eccentric stud into a pinvise, and cut the slot with a screwhead file. Start at one edge and proceed over the center to the opposite edge, as shown in Illustration 142.

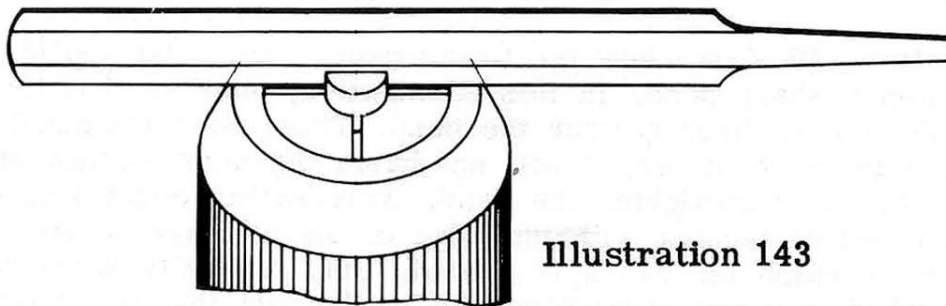

**Illustration 143**

Now hold the file level, and cut to the proper depth.



## PART 13

### ADJUSTING AND FORMING OF CHRONOGRAPH SPRINGS

#### ADJUSTING CHRONOGRAPH SPRINGS

There are two principal types of springs used in the chronograph mechanism, the type of springs which are cut or stamped from flat stock steel, and flat or round wire springs.

In the process of repairing a chronograph, it may be necessary, for various reasons, to adjust these springs. The adjusting of the springs is usually accomplished by bending the spring with pliers, heavy tweezers, or with the use of a lead or brass anvil, a hammer and a punch. It is a good policy to bend only springs made from steel wire with pliers or heavy tweezers. All other springs should be bent exclusively with the use of a lead or brass anvil. The use of the lead or brass anvil to bend chronograph springs is highly recommended, and especially when adjusting very hard springs, no other method of bending the spring should be attempted, as it will usually result in breaking or damaging the spring.

Before attempting to adjust a spring, it should always be tested for hardness with the use of a fine file. If the spring can be filed easily, then it can be bent, even with the use of pliers, without much danger of breaking. However, if the spring is very difficult to file, then it is essential that it be bent with the use of a lead or brass anvil.

In the following, it is explained how springs should be bent with the use of a lead or brass anvil. The application of the hammer or punch squarely on the flat surface of a spring supported by a lead or brass anvil, will always cause the spring to bend upward.

In Illustration 144, we show a method of straightening a spring which is curved over a large area. In such a case, the hammer may be used directly on the spring as illustrated, tapping the spring evenly over the whole area of the bend. For best results, the surface of the hammer that strikes the spring should be rounded, as shown in this Illustration. When tapping the spring with the hammer, the base of the spring should be held between the forefinger and the thumb.

Illustration 145 shows how the brass punch should be applied to straighten a sharp bend. In this Illustration, observe that the punch is placed directly over the bend. Thus, when the punch is tapped with the hammer, it will not harm the other portion of the spring, but only straighten the bend. This spring could also be straightened by tapping with the edge of the hammer, at the same position in which the punch is placed. But, generally speaking, this method is more hazardous, due to the fact that the repair-

man must have absolute control, so that the edge of the hammer strikes the spring squarely. It must be kept in mind, that if the spring is not hit squarely with the edge of the hammer and only one edge of the spring is actually tapped, this may cause the spring to twist out of shape, resulting in the end of the spring binding on, or being too far above the plate when the spring is replaced in the chronograph. From this information, it can be easily understood why the punch is usually the preferred method.

Illustration 146 shows how the tension of a spring can be increased. Note how the punch is placed close to the base of the spring to assure a greater effect. If the tension of the spring has to be increased greatly, do not keep the punch at the same spot, but apply it to different positions over the area of the spring between "A" and "B", as indicated in this Illustration.

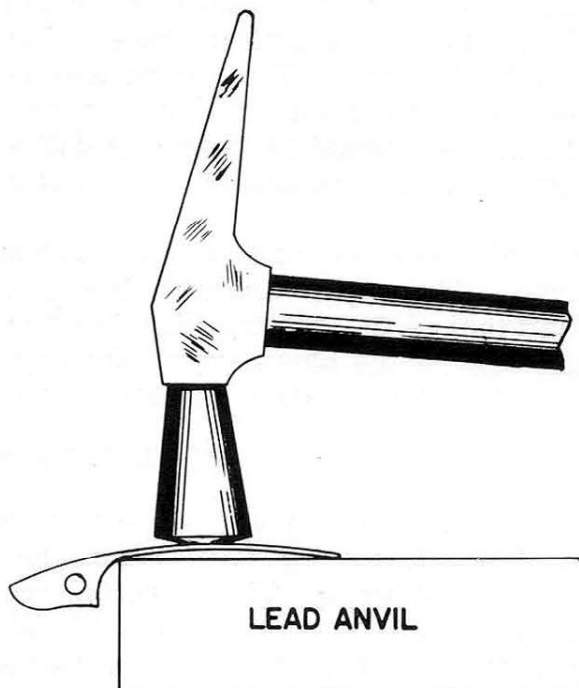

Illustration 144

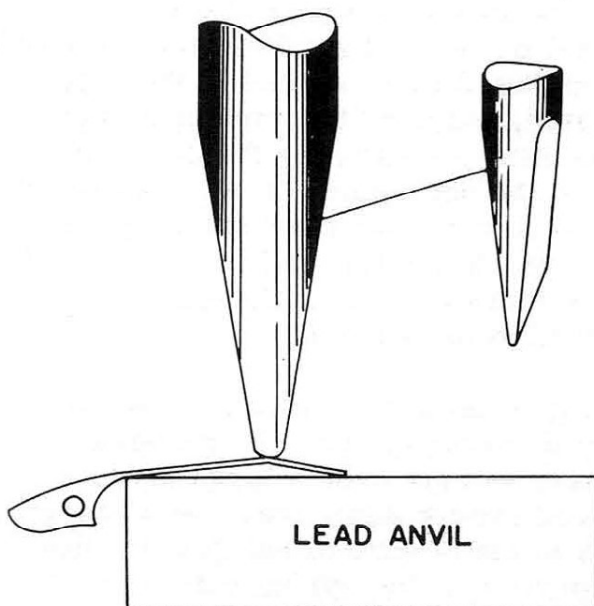

Illustration 145

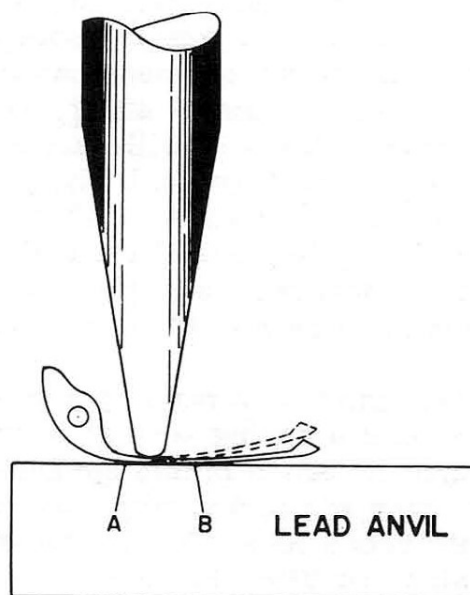

Illustration 146

Illustration 147 shows how to place the spring and the punch, when the working end of the spring should be raised. If the spring should be lowered, naturally the underside of the spring can be tapped at the same location.

Illustration 148 shows how to proceed when a strongly curved spring should be bent to reduce the curve in the spring a certain amount. Place the spring with the inner side of the curve on a curved surface of a brass anvil. The spring may be tapped either by the edge of a hammer or a rounded chisel shape punch. If much bending is required, the spring should be tapped at different points over the surface of the spring from location "A" to location "B".

To increase the curve in a curved spring, place the spring on a brass anvil. The anvil should be filed on a curve which is more accentuated than that of the spring. See Illustration 149. Now tap the spring with the edge of the hammer, as shown in this Illustration. The spring will then take the position as indicated by the dotted line.

#### FORMING A WIRE SPRING

If a wire spring is broken and must be replaced, a new spring can be made the following way. Place the two pieces of the broken spring on a piece of wood. The pieces of the spring should be placed in such a position that they form the original shape of the spring, as shown in Illustration 150. Then, the locations where the spring must be bent should be marked by dots on the wood, as indicated in this Illustration. The marks can be made either by a sharp pencil or a needle. These marks indicate where straight pins must be tapped into the wood in order to bend the wire at the correct locations. After the wood is marked, remove the old spring and tap pins on the dots 1 and 2 into the wood. See Illustration 151. Cut off the pins with a pair of side-cutters, so only about 1 mm is above the level of the spring. Then take a wire that is the same dimensions as the spring. Place one end of the wire between the pins 1 and 2, as indicated, and bend the wire around pin 2, far enough that it will stay in the position indicated by the dotted line. Now tap another pin in the position of the dot number 3, and shorten it like the previous pins. Bend the wire around this pin enough that it will stay in the position indicated by the dotted line in Illustration 152. Then proceed the same way over the marks 4 and 5. On mark 6, no pin must be placed, as no further bend is to be made.

This method of bending a wire spring is used to an advantage when making a spring such as previously illustrated. The reason being that the bends in this spring are sharp and not over a large area. In a case where a spring must be curved over a large area, for instance to form a loop, etc., the use of pins in the block will not give the desired results. In such a case, the portion of the spring that must be curved over a large area, should be formed with round nose pliers.

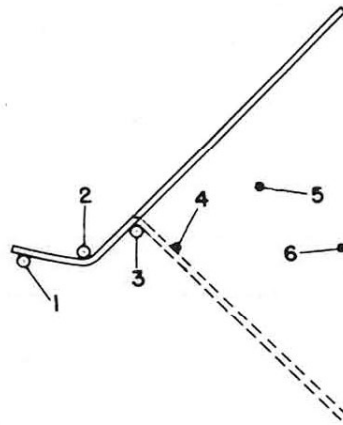
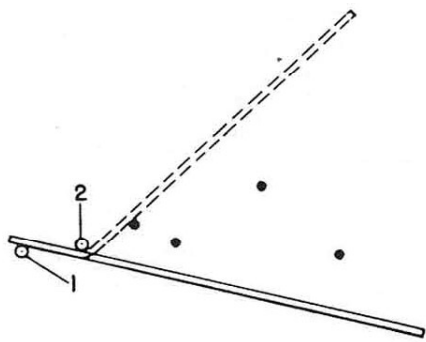
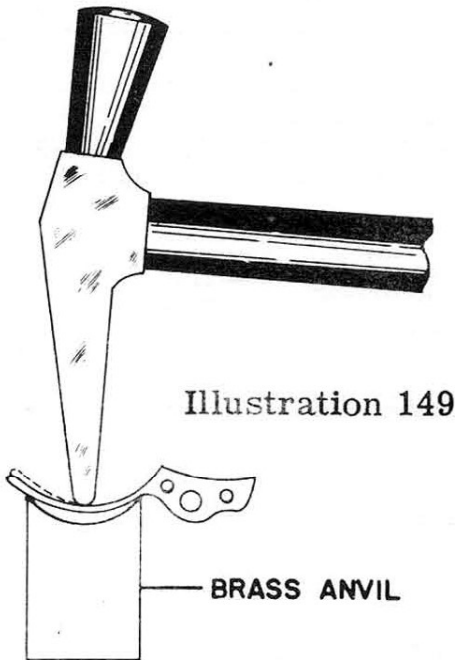
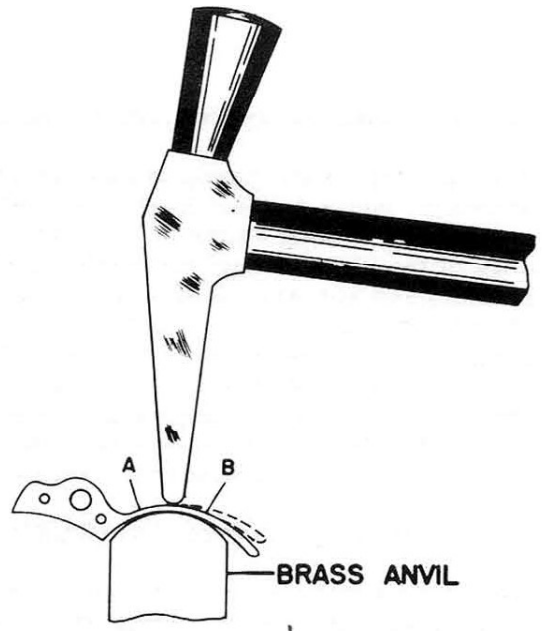
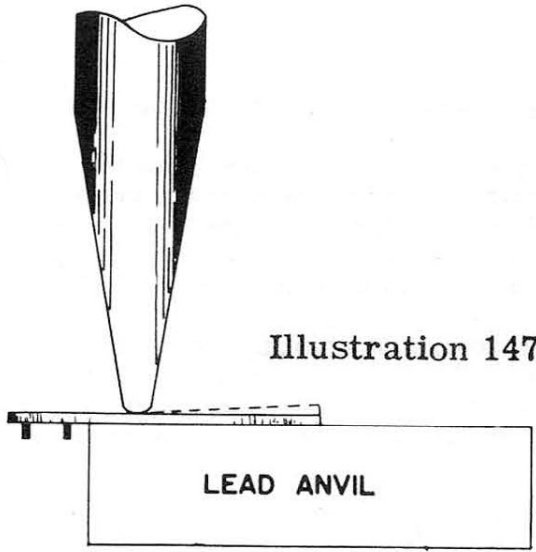

## PART 14

### CHRONOGRAPH HANDS

#### SETTING THE PROPER CLEARANCE OF THE HANDS ON A CHRONOGRAPH

The spacing of the hands should be closely observed in a chronograph, as the increased number of hands also increases the hazard of the hands catching on one another, or binding on the dial or the crystal. It is not sufficient to check the clearance of the hands in just one position, for example at 12 o'clock and with the sweep second hand at a zero position, but they should be checked all around the dial. This is necessary since often one or several hands fail to keep the proper clearance from the dial, crystal, or from the other hands as they turn around. The general tendency should be to keep the hands close to the dial, but always giving a proper clearance for a safe functioning. Illustration 153 shows the proper spacing of the hands from the dial, from one hand to the other, and from the sweep second hand to the crystal in a split second chronograph.

#### TIGHTENING OF TUBES ON SWEEP SECOND HANDS

When the sweep second hand does not hold sufficiently tight on the post of the seconds wheel, the hole in the tube of the hand can be closed to correct the condition. Any squeezing of the tube on the hand with tweezers or pliers will not give the desired results, but will more than likely ruin this tube. In order to stand the shock of returning to zero without changing position on the seconds wheel post, the tube on the hand must hold tight all around the post, not only in some spots. To achieve this, place the tube into a chuck in the lathe, Illustration 154, and tighten the spindle. This will squeeze all around the tube evenly so that the hand can hold tight again when replaced on the seconds wheel post.

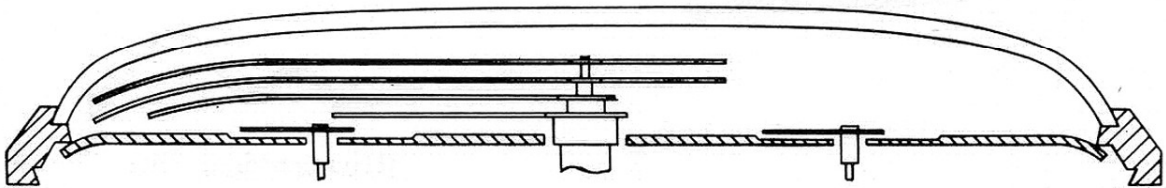

Illustration 153

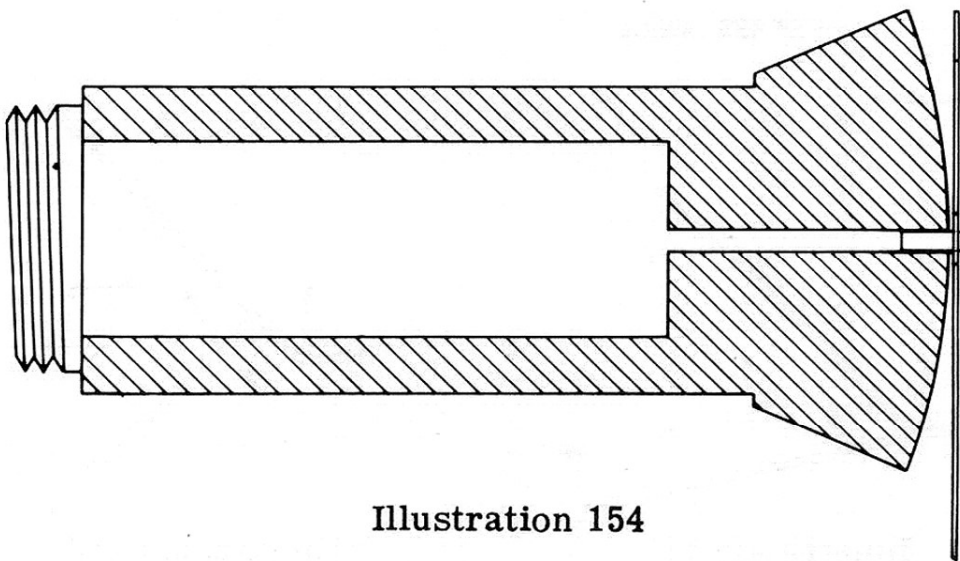

Illustration 154





## PART 15





### NOMENCLATURE OF PARTS

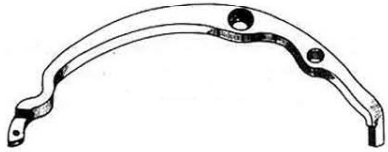
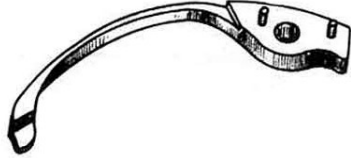
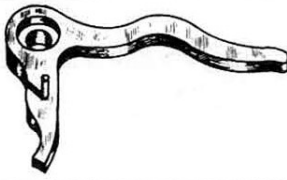

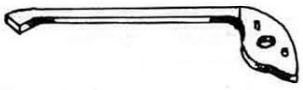

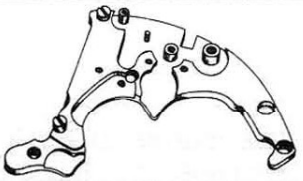
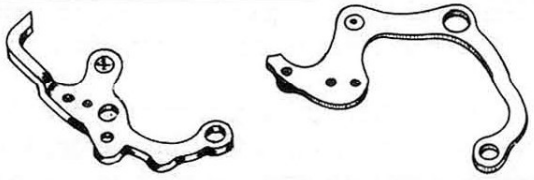
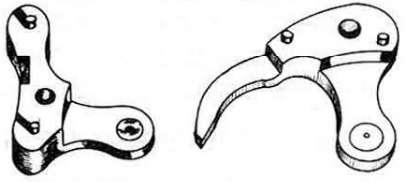
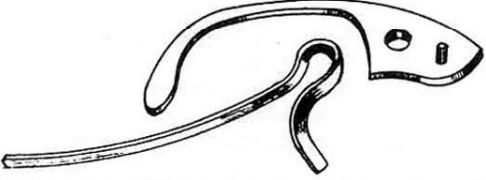

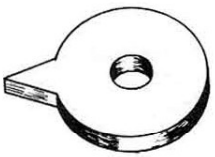
The names of each individual part in the chronograph have not been standardized, the same part being identified by several names, varying according to the name given by the manufacturer or by the various names used in different localities to identify the same part.

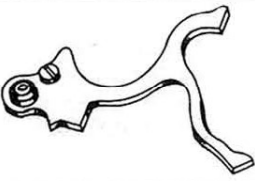
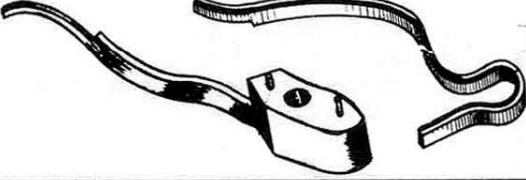

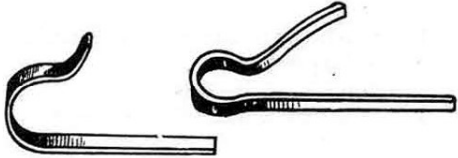

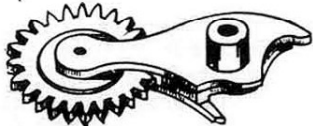
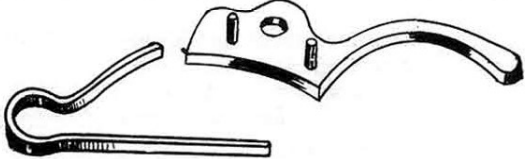

For identification purposes, the following Nomenclature of Parts illustrate each part, along with the various names by which the part is identified. The first name in each series is the name used in the Esembl-O-Graf Library to identify the part. Any additional names in each series are placed here for the convenience of the watchmaker, so that he may associate the illustrated part with the various names by which it is identified.

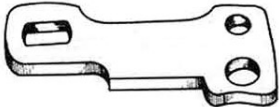
#### NOMENCLATURE OF PARTS FOR MINUTE REGISTER MECHANISM

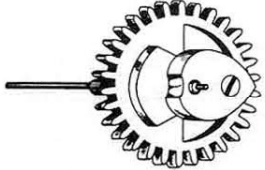
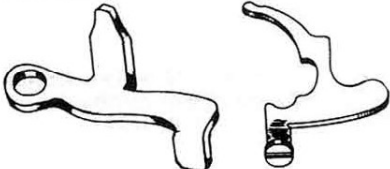
<ol style="list-style-type: none"> <li>1. Actuating Detent Lever</li> <li>2. Operating Lever</li> <li>3. Push Piece Lever</li> <li>4. Stop Detent</li> <li>5. Chronograph Push Lever</li> </ol>	
<ol style="list-style-type: none"> <li>1. Actuating Detent Lever Spring</li> <li>2. Operating Lever Spring</li> <li>3. Push Piece Lever Spring</li> <li>4. Stop Detent Spring</li> <li>5. Chronograph Push Lever Spring</li> </ol>	
<ol style="list-style-type: none"> <li>1. Brake Lever</li> <li>2. Brake</li> <li>3. Stop Lever</li> </ol>	
<ol style="list-style-type: none"> <li>1. Brake Lever Spring</li> <li>2. Brake Spring</li> <li>3. Stop Lever Spring</li> </ol>	
<ol style="list-style-type: none"> <li>1. Castle Wheel</li> <li>2. Pillar Wheel</li> <li>3. Chronograph Split Ratchet</li> <li>4. Column Wheel</li> </ol>	
<ol style="list-style-type: none"> <li>1. Castle Wheel Pawl</li> <li>2. Pillar Wheel Jumper</li> <li>3. Chronograph Split Ratchet Spring</li> <li>4. Column Wheel Jumper</li> </ol>	

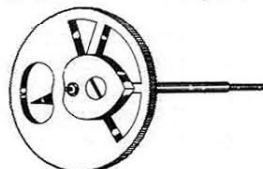

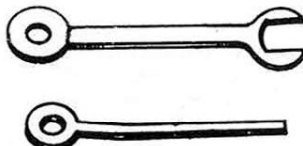
<ol style="list-style-type: none"> <li>1. Chronograph Assembly Plate</li> <li>2. Rest Plate for Recording Mechanism</li> </ol>	
<ol style="list-style-type: none"> <li>1. Chronograph Pivoted Detent</li> <li>2. Coupling Yoke</li> <li>3. Chronograph Detent</li> </ol>	
<ol style="list-style-type: none"> <li>1. Chronograph Pivoted Detent Bridge</li> <li>2. Coupling Clutch Bridge</li> <li>3. Intermediate Push Piece Bridge</li> <li>4. Intermediate Chronograph Wheel Cock</li> </ol>	
<ol style="list-style-type: none"> <li>1. Chronograph Pivoted Detent Spring</li> <li>2. Coupling Clutch Spring</li> <li>3. Intermediate Chronograph Wheel Spring</li> </ol>	
<ol style="list-style-type: none"> <li>1. Connecting Push Piece</li> <li>2. Square</li> </ol>	
<ol style="list-style-type: none"> <li>1. Dart Tooth</li> <li>2. Finger</li> <li>3. Flirt Piece</li> </ol>	
<ol style="list-style-type: none"> <li>1. Double Intermediate Pinion</li> <li>2. Oscillating Pinion</li> </ol>	
<ol style="list-style-type: none"> <li>1. Flyback Lever</li> <li>2. Hammer Mounted</li> <li>3. Hammer Complete</li> <li>4. Return to Zero Lever</li> </ol>	
<ol style="list-style-type: none"> <li>1. Flyback Lever Spring</li> <li>2. Hammer Spring</li> <li>3. Hammer Spring Sole Shaped</li> <li>4. Return to Zero Lever Spring</li> </ol>	

<ol style="list-style-type: none"> <li>1. Flyback Trip Lever</li> <li>2. Hammer Bolt</li> </ol>	
<ol style="list-style-type: none"> <li>1. Flyback Trip Lever Spring</li> <li>2. Hammer Bolt Spring</li> </ol>	
<ol style="list-style-type: none"> <li>1. Intermediary Wheel</li> <li>2. Coupling Wheel</li> <li>3. Intermediate Chronograph Wheel</li> </ol>	
<ol style="list-style-type: none"> <li>1. Intermittent Lever and Wheel Assembly</li> <li>2. Sliding Gear Mounted</li> <li>3. Resetting Detent</li> <li>4. Chronograph Lever with Wheel</li> <li>5. Intermediate Counter Wheel and Lever</li> </ol>	
<ol style="list-style-type: none"> <li>1. Intermittent Lever Spring</li> <li>2. Sliding Gear Spring</li> <li>3. Chronograph Lever Spring</li> <li>4. Intermediate Counter Wheel Spring</li> </ol>	
<ol style="list-style-type: none"> <li>1. Joint Hook</li> <li>2. Operating Lever Hook</li> <li>3. Push Lever Hook</li> </ol>	
<ol style="list-style-type: none"> <li>1. Minute Register Heart</li> <li>2. Minute Heart</li> <li>3. Minute Counter Heart Piece</li> </ol>	
<ol style="list-style-type: none"> <li>1. Minute Register Pawl</li> <li>2. Minute Recording Jumper</li> <li>3. Minute Register Click</li> <li>4. Yielder</li> <li>5. Minute Wheel Register Spring</li> <li>6. Minute Counter Jumper</li> </ol>	
<ol style="list-style-type: none"> <li>1. Minute Register Pawl Adjusting Plate</li> <li>2. Slide</li> </ol>	



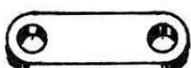

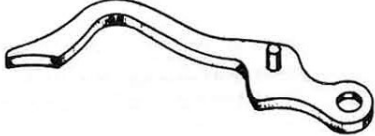
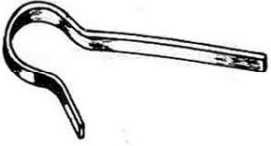
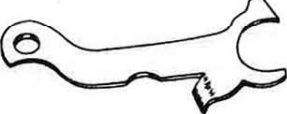
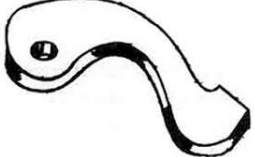
<ol style="list-style-type: none"> <li>1. Minute Register Wheel</li> <li>2. Minute Recording Runner with Heart</li> <li>3. Mounted Register Wheel</li> <li>4. Numerator Wheel Complete</li> <li>5. Minute Counter Wheel</li> </ol>	
<ol style="list-style-type: none"> <li>1. Push Piece for Setting Back to Zero</li> <li>2. Flyback Lever</li> <li>3. Bent Rocking Bar</li> <li>4. Negator Zero Action Detent</li> </ol>	
<ol style="list-style-type: none"> <li>1. Seconds Heart</li> <li>2. Chronograph Heart</li> </ol>	
<ol style="list-style-type: none"> <li>1. Seconds wheel</li> <li>2. Chronograph Runner with Heart</li> <li>3. Mounted Chronograph Center Wheel</li> <li>4. Chronograph Center Staff Complete</li> <li>5. Center Chronograph Wheel</li> </ol>	
<ol style="list-style-type: none"> <li>1. Seconds Wheel and Minute Register Wheel Bridge</li> <li>2. Chronograph Bridge</li> <li>3. Minute Counter and Center Chronograph Wheel Cock</li> </ol>	
<ol style="list-style-type: none"> <li>1. Seconds Wheel Tension Spring</li> <li>2. Friction Spring</li> <li>3. Tension Spring</li> </ol>	
<ol style="list-style-type: none"> <li>1. Wheel-Over-Fourth-Wheel</li> <li>2. Driving Wheel</li> <li>3. Top Fourth Wheel</li> <li>4. Wheel Over Seconds Wheel</li> <li>5. Intermediate Chronograph Wheel</li> <li>6. Wheel on Fourth Wheel</li> <li>7. Chronograph Wheel</li> </ol>	

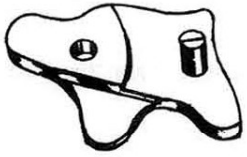
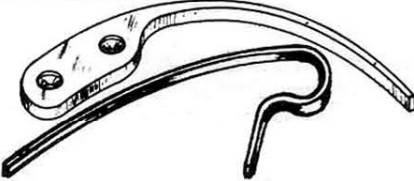
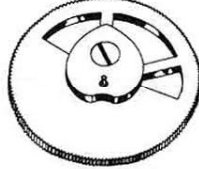
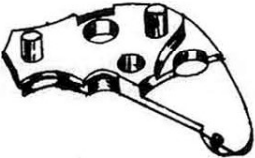
### NOMENCLATURE OF PARTS FOR HOUR REGISTER MECHANISM

<ol style="list-style-type: none"> <li>1. Articulation Arm</li> <li>2. Connecting Plate</li> </ol>	
--	---

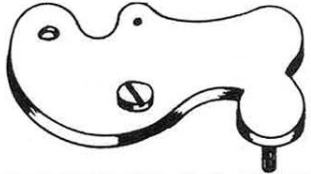

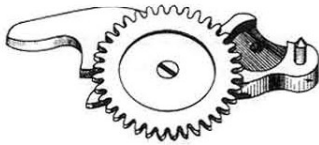

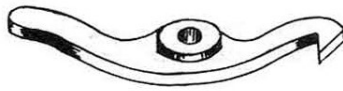
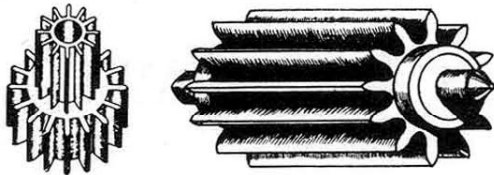
<ol style="list-style-type: none"> <li>1. Hour Brake Lever</li> <li>2. Hour Recording Stop Lever</li> </ol>	
<ol style="list-style-type: none"> <li>1. Hour Brake Lever Spring</li> <li>2. Hour Recorder Stop Lever Spring</li> </ol>	
<ol style="list-style-type: none"> <li>1. Hour Clutch Spring</li> <li>2. Fork</li> </ol>	
<ol style="list-style-type: none"> <li>1. Hour Flyback Detent</li> <li>2. Hammer Detent</li> </ol>	
<ol style="list-style-type: none"> <li>1. Hour Flyback Lever</li> <li>2. Hour Hammer</li> <li>3. Hour Return to Zero Lever</li> </ol>	
<ol style="list-style-type: none"> <li>1. Hour Flyback Lever Bridge</li> <li>2. Hour Hammer Cock</li> </ol>	
<ol style="list-style-type: none"> <li>1. Hour Flyback Lever Spring</li> <li>2. Hour Hammer Spring</li> </ol>	
<ol style="list-style-type: none"> <li>1. Hour Register Wheel</li> <li>2. Hour Recording Wheel</li> </ol>	
<ol style="list-style-type: none"> <li>1. Hour Register Wheel Bridge</li> <li>2. Hour Recorder Bridge</li> <li>3. Hour Recorder Cock</li> </ol>	



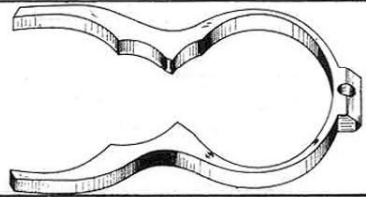

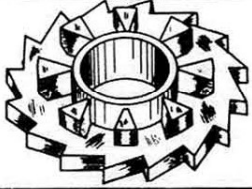

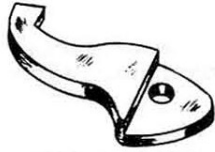
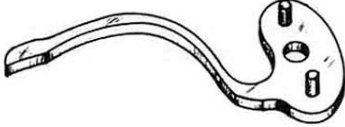
<ol style="list-style-type: none"> <li>1. Hour Register Wheel Tension Spring</li> <li>2. Hour Recording Wheel Friction Member</li> <li>3. Friction Spring for Numerator Hour Wheel</li> </ol>	
<ol style="list-style-type: none"> <li>1. Intermediate Hour Flyback Detent</li> <li>2. Pawl</li> </ol>	
<ol style="list-style-type: none"> <li>1. Intermediate Hour Wheel Tension Spring</li> <li>2. Conveyor Wheel Endshake Bridle</li> </ol>	
<ol style="list-style-type: none"> <li>1. Intermediate Hour Yoke and Wheel</li> <li>2. Conveyor Mounted</li> </ol>	
<ol style="list-style-type: none"> <li>1. Intermediate Hour Yoke Spring</li> <li>2. Conveyor Spring</li> </ol>	
<ol style="list-style-type: none"> <li>1. Lever Arm Hour Yoke</li> </ol>	
<ol style="list-style-type: none"> <li>1. Transmission Pinion</li> <li>2. Driving Pinion</li> <li>3. Transmition Pinion</li> </ol>	

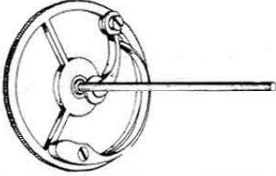
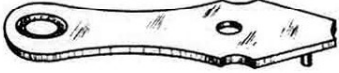
**NOMENCLATURE OF PARTS FOR SPLIT SECOND MECHANISM**

<ol style="list-style-type: none"> <li>1. Split Seconds Brake Spring</li> <li>2. Split Seconds Spring Clams</li> </ol>	
--	--

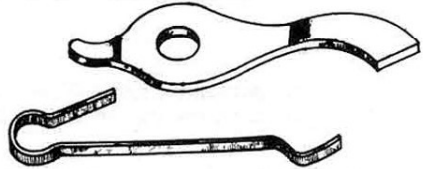
<ol style="list-style-type: none"> <li>1. Split Seconds Brake Spring Holder and Washer</li> <li>2. Clam Set Lid and Rest</li> </ol>	
<ol style="list-style-type: none"> <li>1. Split Seconds Castle Wheel</li> <li>2. Split Seconds Pillar Wheel</li> </ol>	
<ol style="list-style-type: none"> <li>1. Split Seconds Castle Wheel Pawl</li> <li>2. Split Seconds Pillar Wheel Jumper</li> </ol>	
<ol style="list-style-type: none"> <li>1. Split Seconds Joint Hook</li> <li>2. Split Seconds Operating Lever</li> </ol>	
<ol style="list-style-type: none"> <li>1. Split Seconds Joint Hook Spring</li> <li>2. Split Seconds Operating Lever Spring</li> </ol>	
<ol style="list-style-type: none"> <li>1. Split Seconds Lever Spring</li> </ol>	
<ol style="list-style-type: none"> <li>1. Split Seconds Lever with Roller</li> </ol>	
<ol style="list-style-type: none"> <li>1. Split Seconds Wheel</li> </ol>	
<ol style="list-style-type: none"> <li>1. Split Seconds Wheel Bridge</li> <li>2. Split Seconds Cock</li> </ol>	

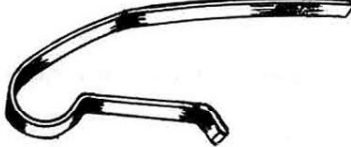
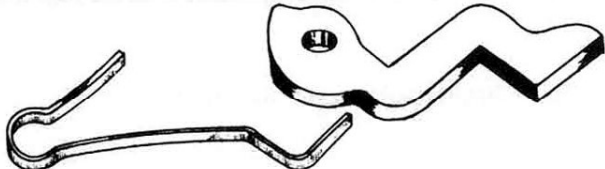
## NOMENCLATURE OF PARTS FOR DATE MECHANISM

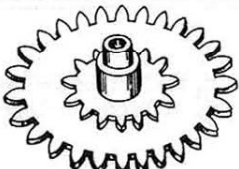
<ol style="list-style-type: none"> <li>1. Date Wheel</li> <li>2. Date Hand Wheel</li> </ol>	
<ol style="list-style-type: none"> <li>1. Date Wheel Jumper</li> <li>2. Date Jumper</li> </ol>	
<ol style="list-style-type: none"> <li>1. Date Wheel Jumper Spring</li> <li>2. Date Jumper Spring</li> </ol>	
<ol style="list-style-type: none"> <li>1. Date Wheel Setting Detent</li> <li>2. Date Corrector</li> </ol>	
<ol style="list-style-type: none"> <li>1. Date Wheel Setting Detent Spring</li> <li>2. Date Corrector Spring</li> </ol>	
<ol style="list-style-type: none"> <li>1. Days Wheel Jumper</li> <li>2. Daily Jumper</li> </ol>	
<ol style="list-style-type: none"> <li>1. Days Wheel Jumper Spring</li> <li>2. Daily Jumper Spring</li> </ol>	
<ol style="list-style-type: none"> <li>1. Hour Wheel with Hairing Wheel</li> <li>2. Double Toothing Hour Wheel</li> </ol>	

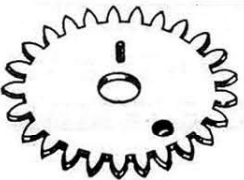
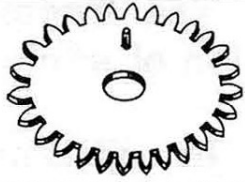
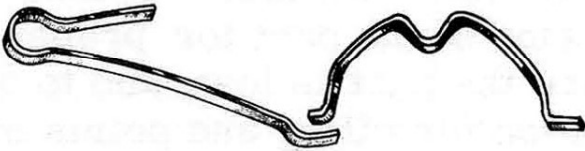
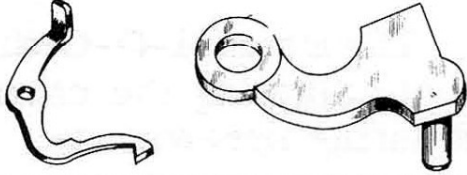
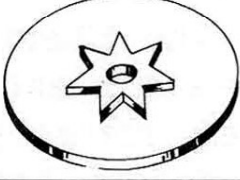
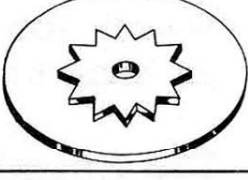
<ol style="list-style-type: none"> <li>1. Intermediate Date Wheel</li> </ol>	
<ol style="list-style-type: none"> <li>1. Intermediate Days Wheel</li> <li>2. Daily Star Intermediate Wheel</li> </ol>	
<ol style="list-style-type: none"> <li>1. Month Wheel Jumper</li> <li>2. Monthly Jumper</li> </ol>	
<ol style="list-style-type: none"> <li>1. Month Wheel Setting Detent</li> <li>2. Month Corrector</li> </ol>	
<ol style="list-style-type: none"> <li>1. Star Wheel of Days</li> <li>2. Daily Star</li> </ol>	
<ol style="list-style-type: none"> <li>1. Star Wheel of Months</li> <li>2. Monthly Star</li> </ol>	

## ANSWERS TO STOCK QUESTIONS USUALLY ASKED BY WATCHMAKERS INQUIRING ABOUT DETAILS OF THE ESEMBL-O-GRAF LIBRARY

1. The Esembl-O-Graf Library shows the exact location of each and every part.
2. In addition to the chart for each and every part and its location, there is also an enlarged isometric drawing of the part for proper identification in cases where the part is lost, and to aid in spotting the exact location for oiling and points of contact.
3. The Esembl-O-Graf Library shows the 1-2-3 method of adjusting the chronograph mechanism eccentric adjusting screws, etc.
4. The Esembl-O-Graf Library shows the proper screw for each part, and its location. Illustration of screw shows the exact number of threads along with the proper head. This protects you in cases where screws are too long or short, or the wrong style shoulder or head used.
5. The Esembl-O-Graf Library explains the hazards of disassembling each part.
6. The Esembl-O-Graf Library explains the hazards of reassembling each part.
7. The Esembl-O-Graf Library shows the instructions on same chart for each part.
8. Never in any case are instructions continued on the next page. You will appreciate the brief but complete instructions on each chart for each part, made possible by writing and rewriting over and over again.



This explains why a watchmaker with an Esembl-O-Graf chart can finish the job in half the time required by the hunt and fit method.

9. The Esembl-O-Graf Library explains the oiling for each part on the chart for that particular part, whether it should be dry and high polish, moistened or oiled.

10. Hundreds of hours were spent on the disassembling and reassembling procedure for each chronograph, time and motion study of handling each part, to determine which part to remove first with the minimum hazard of breakage in conjunction with the reassembling procedure, so as each part could be oiled and adjusted conveniently as the chronograph is assembled.

11. Esembl-O-Graf volumes have illustrations on every page - its really a story told with charts in numerical order. Just lay book on bench tray, take out first part, turn a page and take out the next part, etc. There is absolutely no time lost in study.

12. It only requires a second to turn a page. Therefore, if a chronograph mechanism itself has 30 parts, you use only 30 seconds for using the book, and you save one to three hours by its time study system of disassembly and reassembly procedure.

13. There is an Esembl-O-Graf chart volume for the Rolex Oyster automatic winder. Rolex is one of the finest automatic watches made, and has many more parts than the ordinary automatics that do not need chart guidance.

14. There are three basic types of calendar mechanisms for all calendar watches. The Esembl-O-Graf Library covers each of them.

15. The Esembl-O-Graf Library shows the proper identification for ordering chronograph parts.

16. The Esembl-O-Graf Research Laboratory will serve you on your parts problems at all times.

17. The Esembl-O-Graf Library shows the mainspring sizes of each chronograph along with the least number of parts to be removed in order to replace a mainspring.

18. Esembl-O-Graf volume twenty-four covers the fitting of new parts and their corrections. Also, adjusting of various unusual freak problems you may encounter when fitting a new part that is worn through use.