

WORLD'S ONLY
FULLY ILLUSTRATED
CHRONOGRAPH WATCH COURSE
VOLUME 26

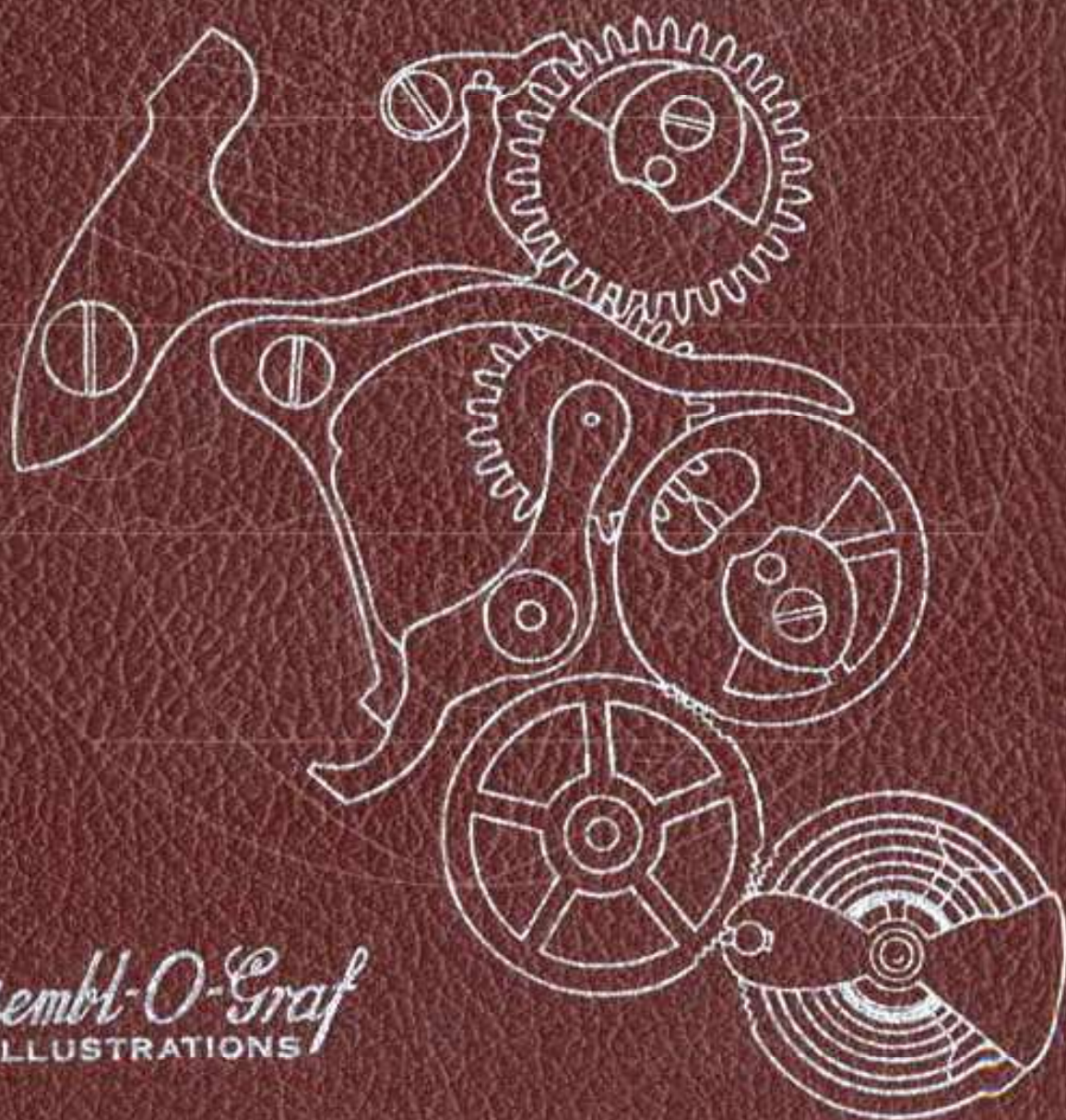

Esembl-O-Graf
ILLUSTRATIONS

IDENTIFICATION OF CHRONOGRAPH

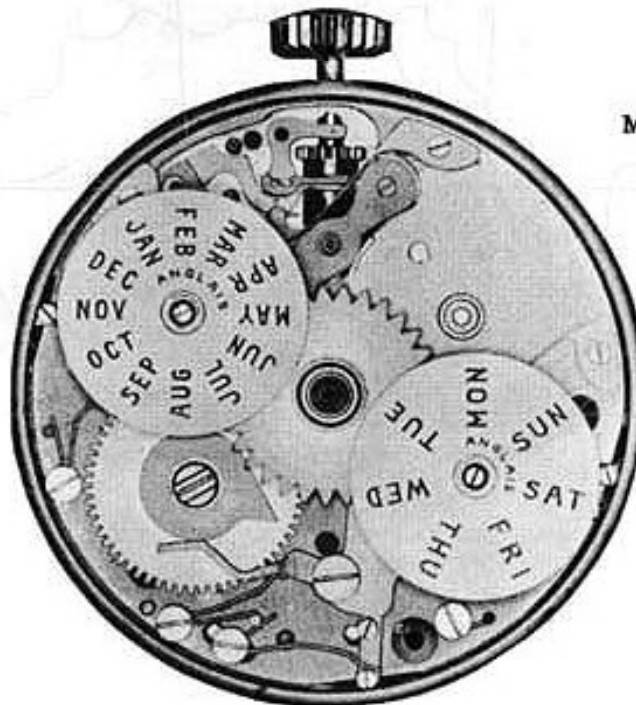

**CAL. 215
MINUTE REGISTER ONLY**

When repairing the Angelus chronograph with minute register only, disregard the section containing the pages 1 to 18 inclusive. These pages cover the repair of the calendar mechanism of the Cal. 217. For repairing the Cal. 215, start on page 19.

**14L
ANGELUS**



**CAL. 217
CHRONODATO
MINUTE REGISTER AND
CALENDAR MECHANISM**



ESEMBL-O-GRAF

THE WORLD'S FIRST FULLY
ILLUSTRATED TEXT BOOK
ON
CHRONOGRAPH REPAIRING
AND ADJUSTING



BY

William O. Smith, Sr.

PRESIDENT AND TECHNICAL DIRECTOR

AND

William O. Smith, Jr.

CHIEF ENGINEER, RESEARCH LABORATORIES

WESTERN PENNSYLVANIA HOROLOGICAL INSTITUTE, INC.
PITTSBURGH, PENNSYLVANIA

This page intentionally left blank

INSTRUCTIONS

For use of book

DISASSEMBLY OF THE CHRONOGRAPH MECHANISM:

1. Study the isometric drawing at top of page 1-A. The isometric drawing was made for the following purposes:
 - A. It helps to identify the part to be removed.
 - B. This drawing aids in pointing out certain locations on the part that are mentioned in the oiling procedure.
 - C. The text refers to certain points on the part. These points are shown in the isometric drawing. This should aid you in finding the exact location on the part that is described in the text.
 - D. It helps you to determine the shape of the part in case a new part has to be made.
 - E. When disassembling the chronograph, each part should be carefully examined as it is removed from the movement. Each part should be checked against the isometric drawings to see that the part is the correct shape and is not broken. Each part should also be checked for any pits of rust, roughness, or burrs and for worn parts which may cause the part not to work properly.
2. At the bottom of the page 1-A is a photograph of a chronograph. In this photograph is the same part painted in black. The part is in the exact location that this part occupies in the watch. Find this location in the watch.
3. Read the disassembly procedure and the hazards in disassembly on page 1 in this book.
4. Remove this part in the same procedure as described in the text.
5. A very important item in disassembling a chronograph is keeping the screws in order, much time will be lost in putting the chronograph together if screws are mixed up. This means you have to hunt for each screw, sometimes trying three or four screws before finding the correct one. It cannot be stressed too strongly that care should be taken so that screws are not mixed up. The system that we advise for beginners, is to replace each individual screw after each part is removed. This naturally eliminates the hazard of mixing up the screws and will save you much time in the end. Do this at least until you become so thoroughly familiar with the chronograph that you no longer feel it is necessary.
6. Continue to follow this procedure throughout the book, and disassemble each part until the last part of the chronograph is removed.

ASSEMBLY OF THE CHRONOGRAPH MECHANISM:

7. When you are ready to assemble the chronograph mechanism, study the isometric drawing on the last part in this book. This drawing should aid you in identifying the part to be assembled and detecting possible defects on the part.
8. At the bottom of this page is a photograph of a chronograph. In this photograph is the same part painted in black. The part is shown in the exact location it occupies in the watch. (Continued on next page)

INSTRUCTIONS (Continued)

9. After you find the correct location for this part in the watch, read the oiling procedure for this part. The oiling procedure for this part is located underneath the isometric drawing. It is best to read the oiling procedure before you put each part in place, as there are certain parts that must be oiled immediately, as it may prove difficult to oil them later.

10. Read the assembly procedure and the hazards in assembling for the last part in this book.

11. Replace the part in its exact location, as shown in photograph, using the procedure as described in the text.

12. Replace the screw that holds this part in place. Of course, the screws should be kept in order as we advised above, but if the screws are not in order or the watch was received with screws mixed up, you will find a screw drawn for each part that requires a screw, at the bottom of the text page.

13. After replacing this part, replace the next part, etc., until the last part is replaced, which will be part No. 1. For replacing each part, use the procedure as described in the text.

(Note: the assembly of the chronograph is exactly the reverse of the disassembly.)

14. After the chronograph mechanism is assembled, read the functions of the different parts in the mechanism. This should help you to understand more fully the purpose of each part and how it works in conjunction with the other parts. It is to your advantage also to read the function before assembling each part, as many mistakes can be prevented when the assembling is done with an understanding of the function.

15. Read the text on adjustment of eccentric studs. This text should be read with reference to the eccentric stud picture. Now adjust each eccentric stud, one at a time, in the watch, as described in the text. Use the picture to find the position of these studs.

16. Study the text on functional results in this book, and check the chronograph mechanism as described in this text.

NOMENCLATURE OF PARTS FOR CHRONOGRAPH MECHANISM

17. After you have become thoroughly familiar with the chronograph mechanism you can disassemble and assemble the chronograph by using the nomenclature of parts as a guide. This makes it possible for you to use a procedure without going through each page in the book.

18. On each page in this book, the part number and the page number are the same. This makes it convenient for the reader and eliminates any confusion.

NOMENCLATURE OF PARTS FOR CHRONOGRAPH MECHANISM



Star Wheel of Months
Assembly No. 1

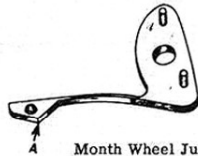

Month Wheel Jumper
Assembly No. 2

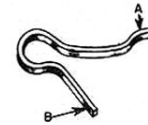

Month Wheel Detent Spring
Assembly No. 3

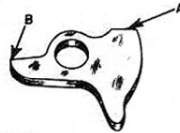

Month Wheel Setting Detent
Assembly No. 4

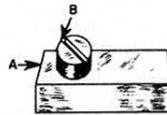

Month Wheel Detent Pusher
Assembly No. 5



Star Wheel of Days
Assembly No. 6



Days Wheel Jumper
Assembly No. 7

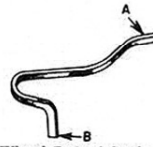

Days Wheel Detent Spring
Assembly No. 8



Days Wheel Setting Detent
Assembly No. 9

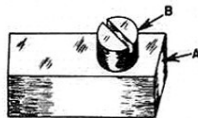

Days Wheel Setting Pusher
Assembly No. 10



Date Wheel
Assembly No. 11



Date Wheel Jumper
Assembly No. 12



Day and Date Actuating Detent
Spring
Assembly No. 13



Day and Date Actuating Detent
Assembly No. 14

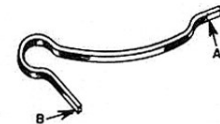

Day and Date Setting Detent Pusher
Spring
Assembly No. 15

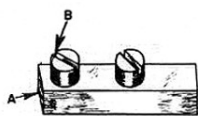

Day and Date Setting Detent Pusher
Assembly No. 16

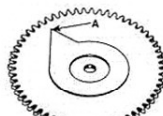

Day and Date Actuating Wheel and
Cam
Assembly No. 17



Hour Wheel with Hairing Wheel
Assembly No. 18



Wheel over Fourth Wheel
Assembly No. 19

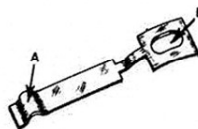

Minute Register Pawl
Assembly No. 20

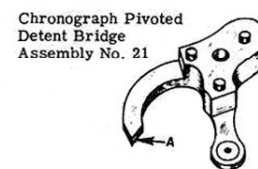

Chronograph Pivoted
Detent Bridge
Assembly No. 21



Intermediary Wheel
Assembly No. 22.





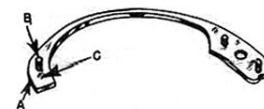





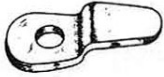
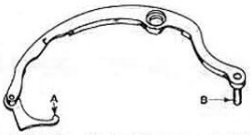

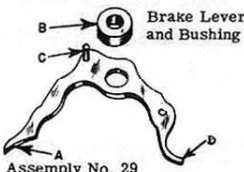

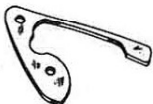
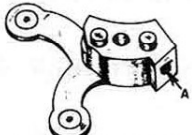
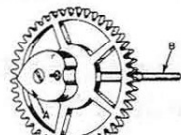
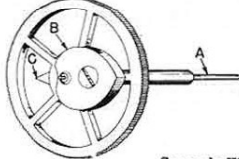

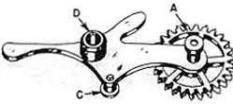
Chronograph Pivoted Detent
Assembly No. 23

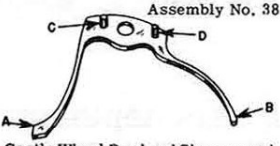
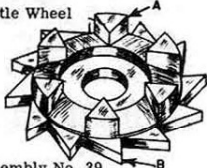

Actuating Detent Lever Spring
Assembly No. 24

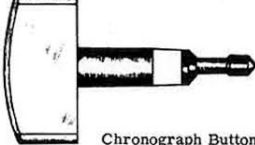
NOMENCLATURE OF PARTS FOR CHRONOGRAPH MECHANISM

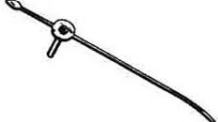
 Joint Hook Plate Assembly No. 25	 Actuating Detent Lever and Joint Hook Assembly No. 26	 Push Piece for Setting Back to Zero Assembly No. 27
 Flyback Lever Assembly No. 28	 Brake Lever and Bushing Assembly No. 29	 Flyback Lever Spring Assembly No. 30
 Brake Lever Spring Assembly No. 31	 Seconds Wheel and Minute Register Wheel Bridge Assembly No. 32	 Minute Register Wheel Assembly No. 33
 Seconds Wheel Assembly No. 34	 Seconds Wheel Tension Spring Assembly No. 35	 Intermittent Lever and Wheel Assembly Assembly No. 36
 Intermittent Lever Spring Assembly No. 37	 Castle Wheel Pawl and Chronograph Pivoted Detent Spring Assembly No. 38	 Castle Wheel Assembly No. 39
 Date Pusher	 Days Pusher	 Month Pusher
 Chronograph Button	 Chronograph Button	 Date Hand
 Minute Register Hand	 Sweep Second Hand	

ADJUSTING ECCENTRIC STUDS . . . THINGS TO CHECK

Listed below are a number of depthings and adjustments controlled by the eccentric studs.

1. Check depthing of wheel over fourth wheel teeth with the intermediary wheel teeth.

CORRECTION: If the depthing is incorrect, it can be corrected by adjusting eccentric stud ES-1.

REFERENCE: Wheel over fourth wheel is Assembly 19.
Intermediary wheel is Assembly 22.

2. Check depthing of intermediary wheel teeth with seconds wheel teeth.

CORRECTION: If depthing is incorrect, it can be corrected by adjusting eccentric stud ES-2.

REFERENCE: Seconds wheel is Assembly 34.
Intermediary wheel is Assembly 22.

3. Check depthing of intermittent wheel teeth with seconds wheel dart tooth.

CORRECTION: If this depthing is incorrect, it may be corrected by adjusting eccentric stud ES-3.

REFERENCE: Seconds wheel is Assembly 34.
Intermittent wheel is Assembly 36.

ADJUSTING ECCENTRIC STUDS

DO NOT REMOVE THESE STUDS

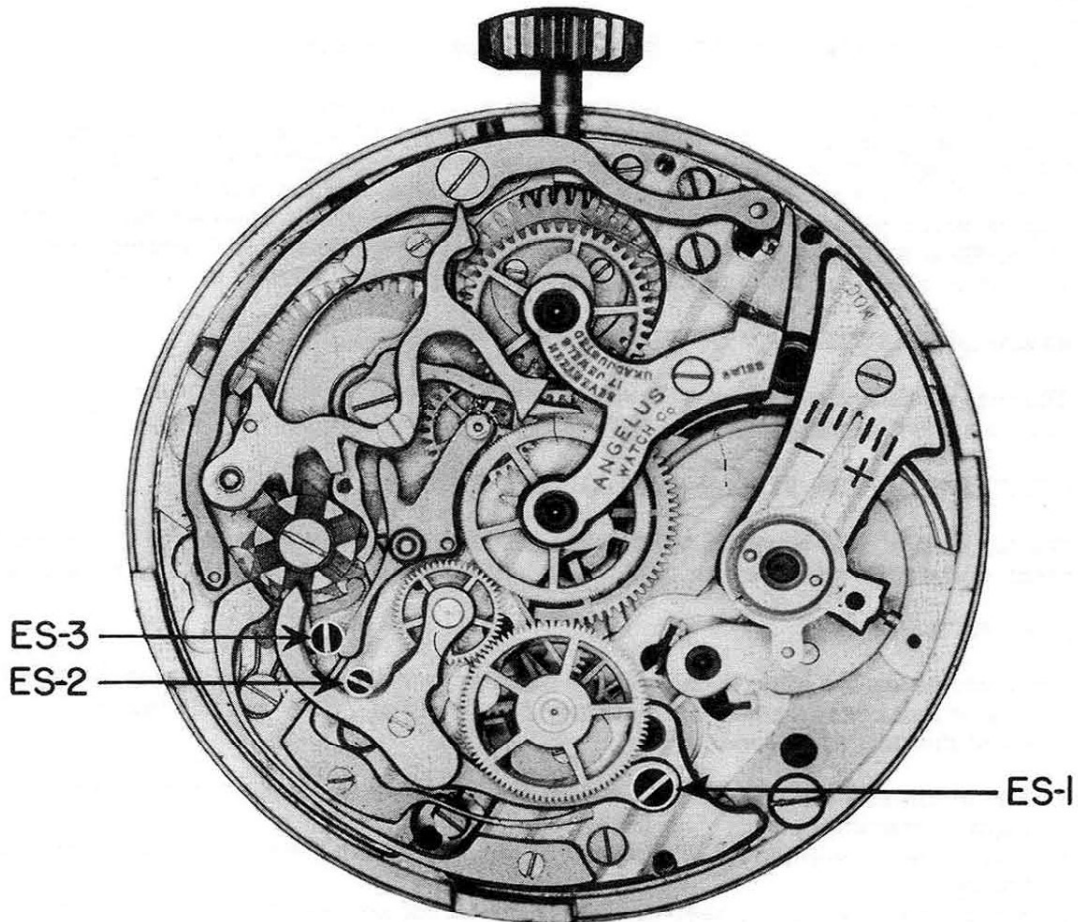

CAUTION

In disassembling or assembling chronograph it is a good policy not to turn eccentric studs. These eccentric studs are used to adjust one part to another and naturally in turning these studs you will lose the desired adjustment of the chronograph mechanism which will cause the chronograph to function incorrectly. Another reason for not turning these studs unless it is necessary is that they soon become loose and will not hold the desired adjustment.

A. DISASSEMBLY PROCEDURE OF STAR WHEEL OF MONTHS:

The star wheel of months is held in position by shouldered screw SS-1, and pivots on this screw. Remove screw and lift months wheel from plate.

(The shape of screw for this part is shown at bottom of page.)

B. HAZARDS IN DISASSEMBLY OF STAR WHEEL OF MONTHS:

The dial on this wheel is very easily marred or scratched. Thus, care should be taken when screwdriver and tweezers are used to remove this wheel.

C. ASSEMBLY PROCEDURE OF STAR WHEEL OF MONTHS:

Place the star wheel of months on the plate at the position shown in the photograph, making sure that the star of the wheel is not on top of end "A" of the months wheel jumper. Now slide the month wheel on the plate until the hole in the wheel is over the proper screw hole in the plate, and the end "A" of the months wheel jumper is meshing into the teeth of this wheel. Replace shouldered screw SS-1, and check to see that the star wheel of months is not binding, and turns free enough so the jumper can properly space the turning of this wheel.

D. HAZARDS IN ASSEMBLY OF STAR WHEEL OF MONTHS:

The dial on this wheel is very easily marred or scratched. Thus, care should be taken when using screwdriver or tweezers in replacing this wheel.

E. FUNCTION OF THE STAR WHEEL OF MONTHS:

The function of this wheel is to indicate the month through a window in the chronograph dial. This wheel is not controlled automatically, but is manually controlled.

REMARKS:

After replacing the dial, it sometimes happens that the month or day of the week letters are not centered in the "windows" of the dial. This may be due to one or more of the following conditions:

1. The automatic changing of the day by the calendar mechanism taking place right at this time.
2. Star wheel of months or star wheel of days binding on the plate and not turning freely.
3. Month wheel or days wheel jumpers not holding sufficient tension on the stars of their respective wheels.
4. The brass disc on which the month or days dial is printed being loose or turned on the star or pinion of these wheels. If the pinion is in an incorrect position in relation to the dial, then the pinion must be held, and the dial turned in a direction which will center the day or month in the "window".

REFERENCE: Months wheel jumper is Assembly 2.

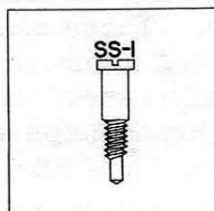

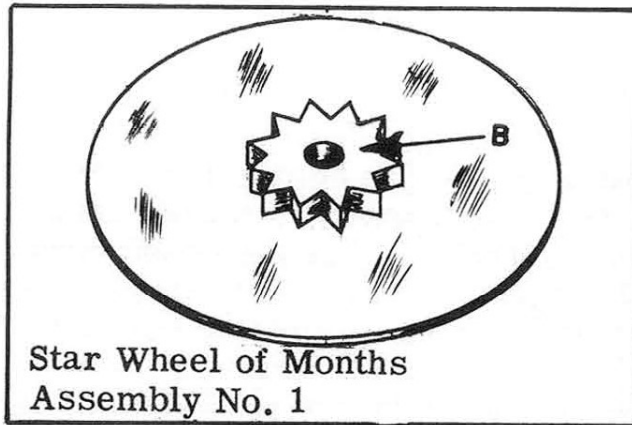

Star Wheel of Months
Assembly No. 1

OILING

The shoulder of screw on which the star wheel of months pivots should be slightly moistened with oil.

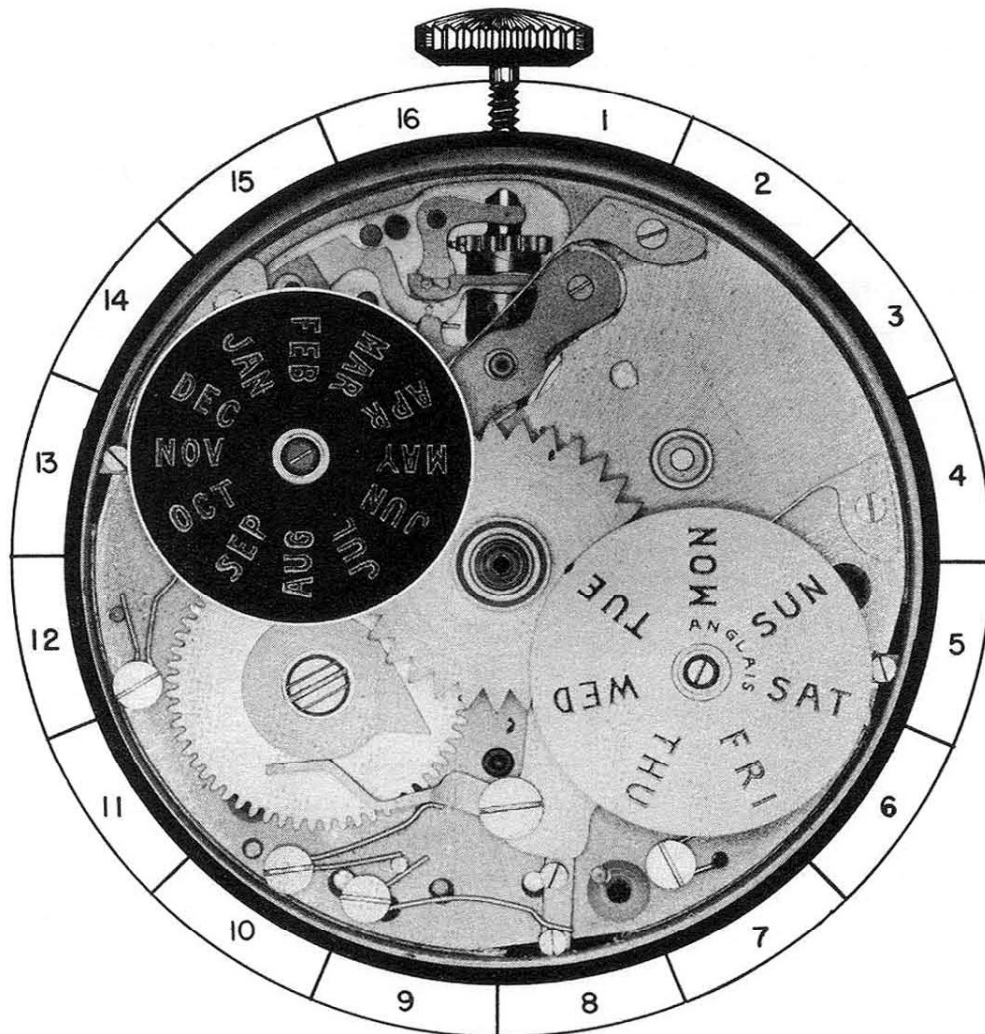

1-A

A. DISASSEMBLY PROCEDURE OF MONTH WHEEL JUMPER:

The month wheel jumper is held in position by fillister head screw FS-1, and steady pins. Remove screw and loosen jumper from plate by sliding a finely ground screwdriver between the plate and jumper. When the steady pins are free in the plate, the jumper may be lifted from the movement.

(The shape of screw for this part is shown at bottom of page.)

B. ASSEMBLY PROCEDURE OF MONTH WHEEL JUMPER:

Place the month wheel jumper on the plate in the position shown in the photograph, with the steady pins over the proper holes in the plate. Now replace fillister head screw FS-1 to hold the jumper in place.

C. FUNCTIONS OF THE MONTH WHEEL JUMPER:

The jumper correctly spaces the turning of the star wheel of months. This prevents the star wheel of months from setting at an incorrect position.

It holds the star wheel of months in a stationary position, so that a bump or jar cannot alter the position of this wheel.

REFERENCE: Star wheel of months is Assembly 1.

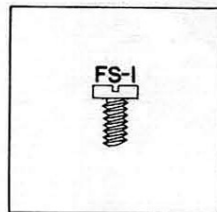

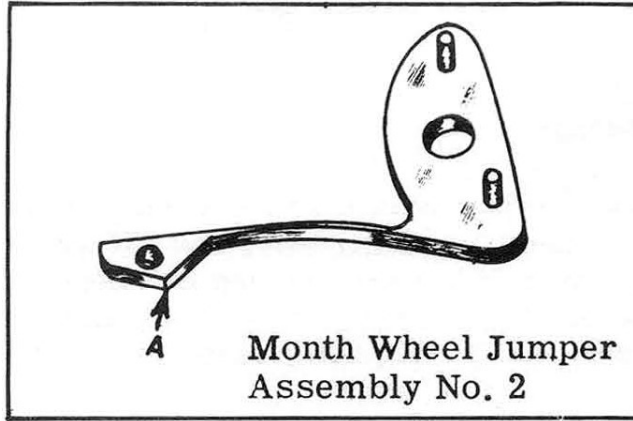

OILING

The month wheel jumper should not be oiled.

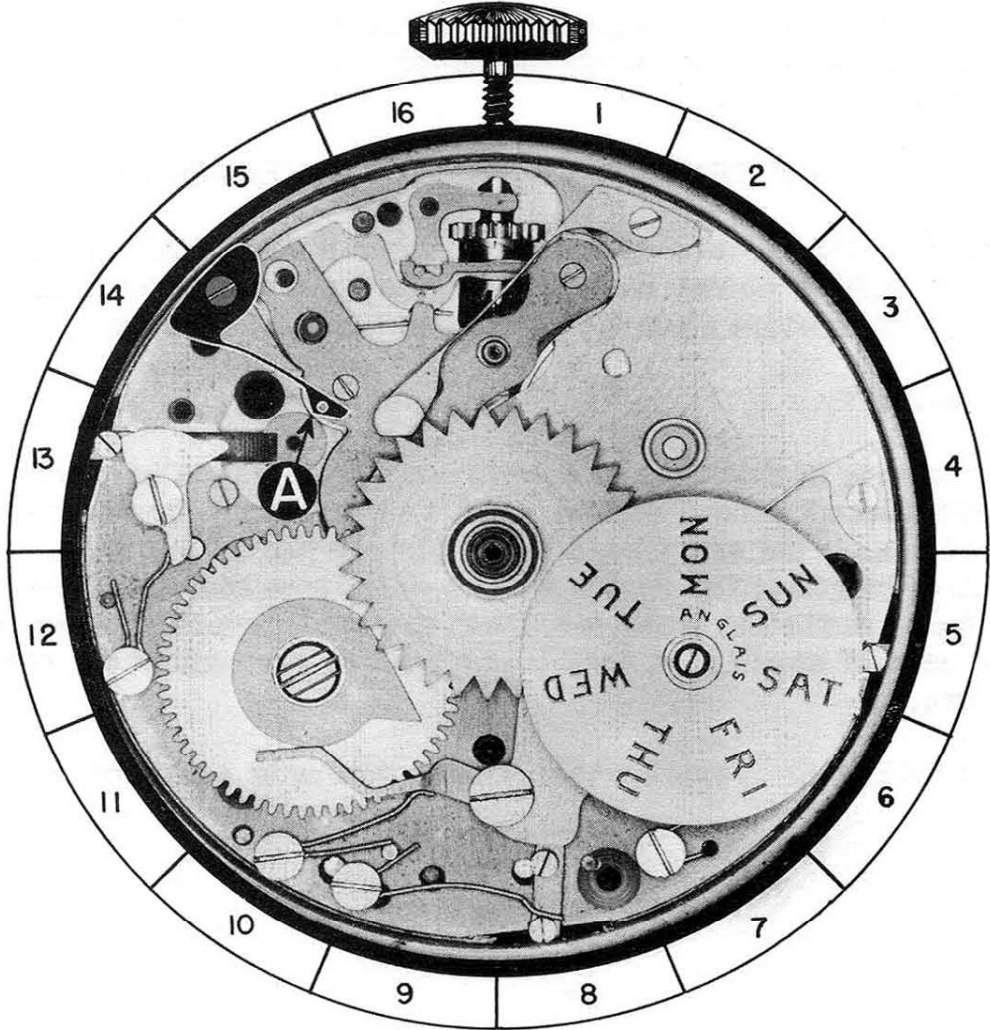

2-A

A. DISASSEMBLY PROCEDURE OF THE MONTH WHEEL SETTING DETENT SPRING:

This spring is held in position by shouldered screw SS-2. To remove spring, loosen screw slightly, and lift the end "A" of spring over part "B" of month wheel setting detent; this will release the tension on the spring. Now remove screw and spring will be free on plate and may be lifted from movement.

(The shape of screw for this part is shown at bottom of page.)

B. ASSEMBLY PROCEDURE OF THE MONTH WHEEL SETTING DETENT SPRING:

Place the spring on the plate with the end "B" of spring against post "C" in plate, and the end "A" of spring in the position shown by the dotted line in the photograph. Replace shouldered screw SS-2, but do not tighten screw. Now lift end "A" of spring and place in position shown on photograph, and tighten screw to hold spring in place.

C. FUNCTION OF THE MONTH WHEEL SETTING DETENT SPRING:

The function of this spring is to hold the end "A" of the month wheel setting detent towards the outside of the watch, and return it to this position after it has been pushed and released.

REMARKS:

Any spring of this type in the chronograph, that is held in place by a shouldered screw, should work freely and not bind under head of screw. If the screwhead binds the spring to the plate, the effective length of the spring will be only from the end of the spring to the screwhead. However, when the spring works freely under the head of screw, the spring is effective throughout its entire length.

REFERENCE: Month wheel setting detent is Assembly 4.

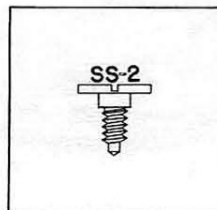

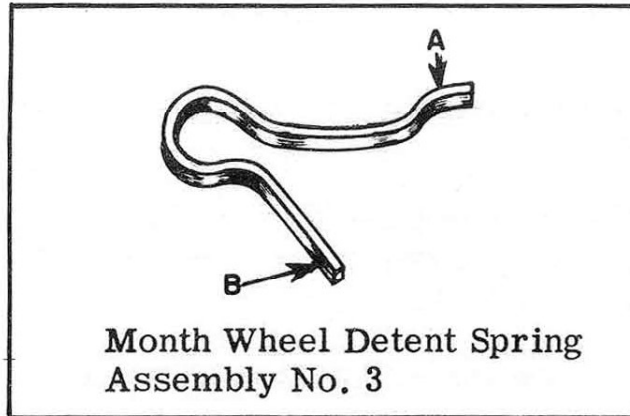

OILING

The end "A" of spring should be slightly moistened with oil at point of contact with the month wheel setting detent.

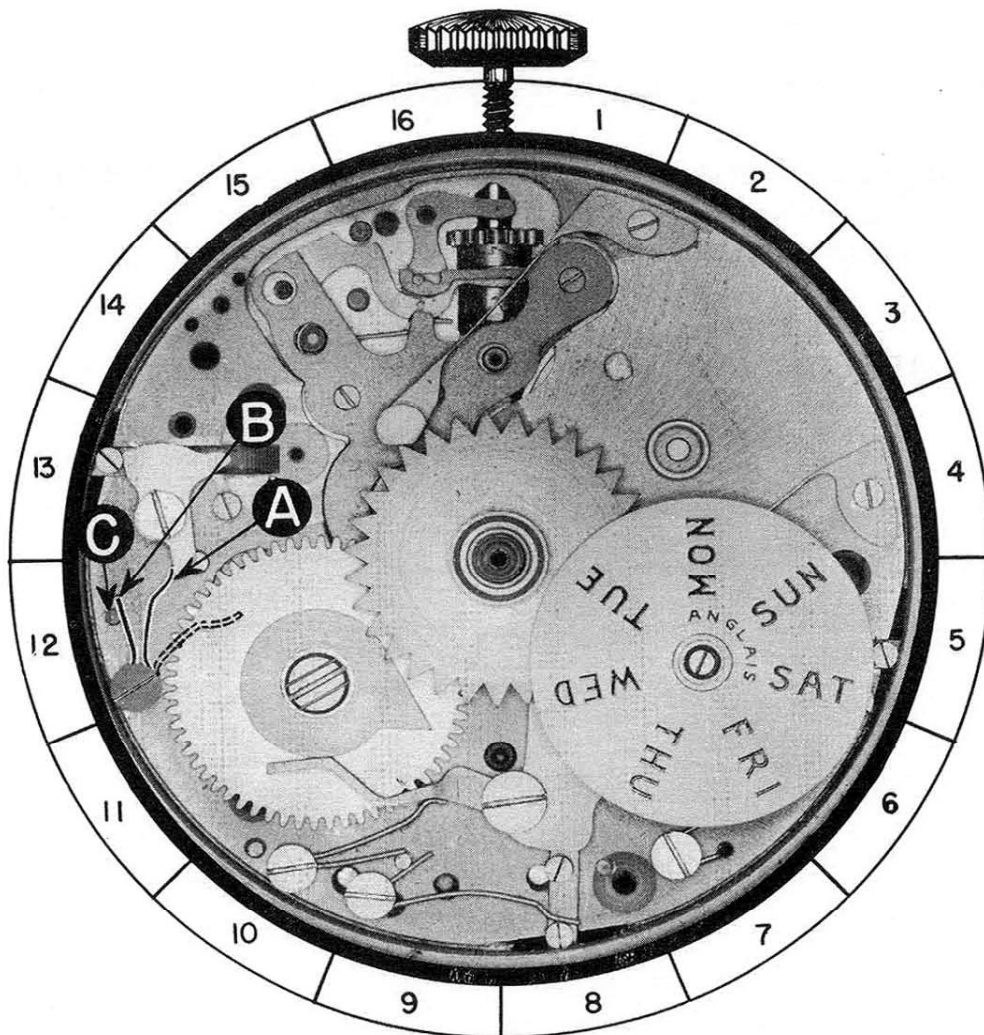

3-A

A. DISASSEMBLY PROCEDURE OF MONTH WHEEL SETTING DETENT:

This detent is held in position by shouldered screw SS-3, and pivots on this screw. Remove the screw and the detent will be free on the plate, and may be lifted from the movement.

(The shape of screw for this part is shown at bottom of page.)

B. ASSEMBLY PROCEDURE OF MONTH WHEEL SETTING DETENT:

Place the detent on the plate in the position shown in the photograph, with the hole in the detent over the proper screw hole in the plate. Now replace shouldered screw SS-3, to hold the detent in position. The detent should pivot freely under the head of this screw.

C. FUNCTION OF THE MONTH WHEEL SETTING DETENT:

The function of this detent, when pushed, is to turn the star wheel of months one tooth. This makes it possible to set the month wheel manually to indicate the correct month on the dial.

REFERENCE: Star wheel of months is Assembly 1.

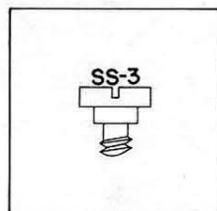

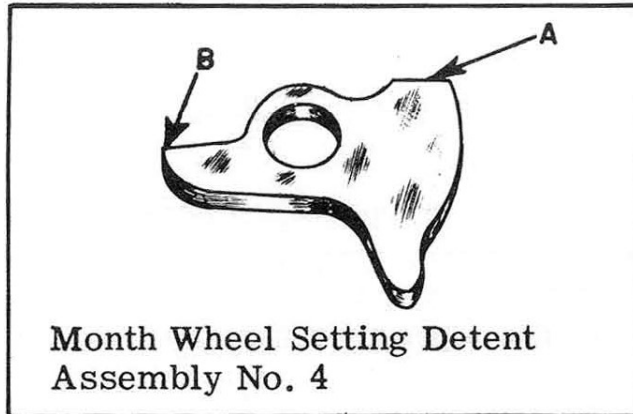

Month Wheel Setting Detent
Assembly No. 4

OILING

The shouldered screw on which the detent pivots should be slightly moistened with oil. The end "A" of detent should be slightly moistened with oil at point of contact with screw head.

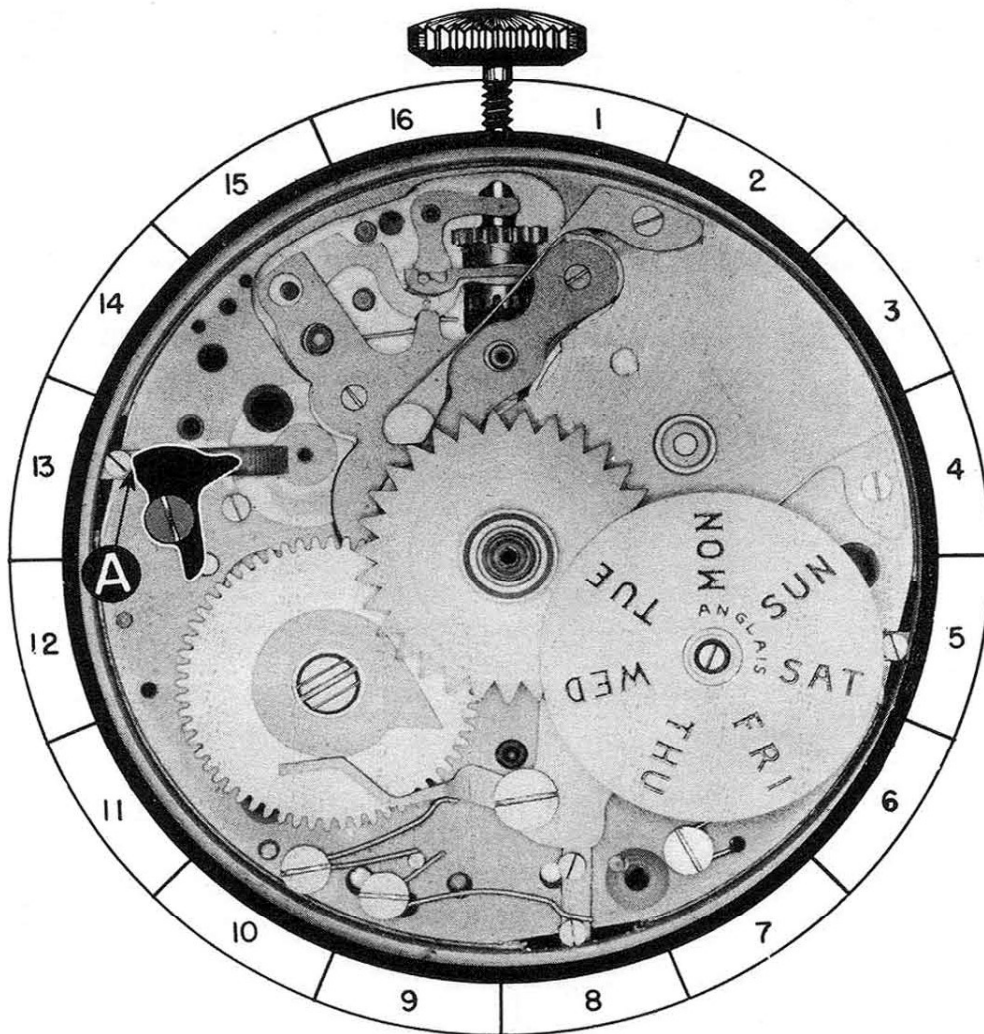

4-A

**A. DISASSEMBLY PROCEDURE OF MONTH WHEEL DETENT
PUSHER:**

Slide the pusher towards the center of the watch until the end "A" of pusher has moved from underneath the case ring. The case ring is indicated by the letter "C" in the photograph. When pusher is free of ring, it may be lifted from the recess and removed.

**B. ASSEMBLY PROCEDURE OF MONTH WHEEL DETENT
PUSHER:**

Place the pusher in the recess at the position indicated in the photograph, with the end "A" of pusher towards the outside of the watch. Now slide the pusher towards the outside of the watch until the end "A" of pusher is under the case ring, and the screw head "B" is resting against the ring. This part will be held in position by the next part to be replaced.

C. FUNCTION OF THE MONTH WHEEL DETENT PUSHER:

The function of this pusher, when pushed, is to move the month wheel setting detent, which will turn the star wheel of months.

REFERENCE: Month wheel setting detent is Assembly 4.
Star wheel of months is Assembly 1.

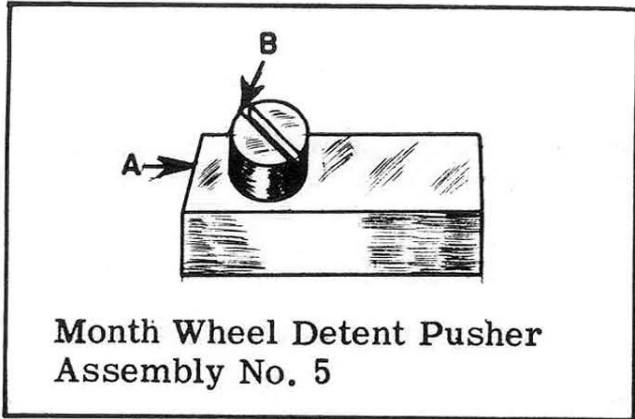

OILING

The surfaces of the month wheel detent pusher that contact the plate should be moistened with oil.

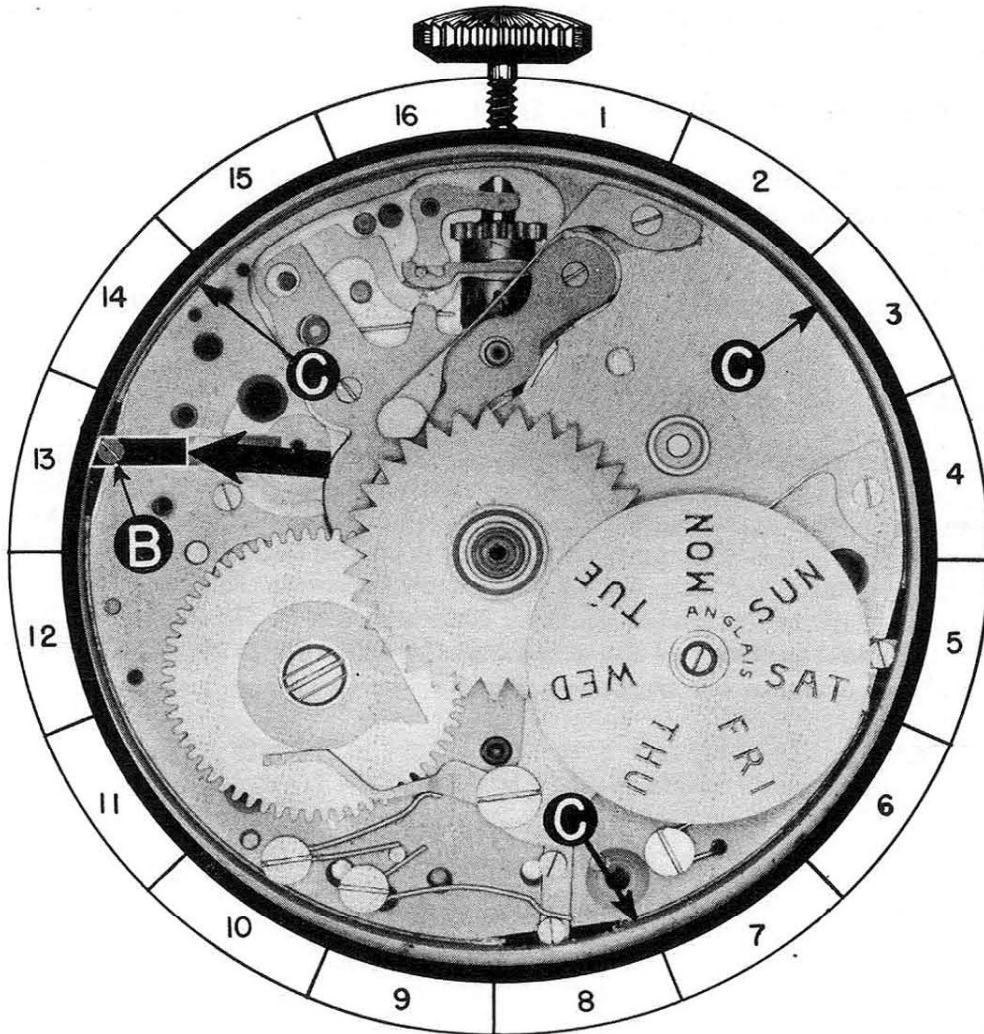

5-A

A. DISASSEMBLY PROCEDURE OF STAR WHEEL OF DAYS:

The star wheel of days is held in position by shouldered screw SS-4, and pivots on this screw. Remove screw and lift star wheel of days from movement.

(The shape of screw for this part is shown at bottom of page.)

B. HAZARDS IN DISASSEMBLY OF STAR WHEEL OF DAYS:

The dial on this wheel is very easily marred or scratched. Thus, care should be taken when screwdriver and tweezers are used to remove this wheel.

C. ASSEMBLY PROCEDURE OF STAR WHEEL OF DAYS:

Place the shouldered screw SS-4 in the star wheel of days. Now place the star wheel of days in the position shown in the photograph, with the pilot of the screw in the proper screwhole. Now move the end "A" of days wheel jumper from under the star of the star wheel of days so that the end "A" of the jumper is meshing into the teeth of this wheel. When end "A" of the jumper is meshing into the teeth of this wheel, the screw may be tightened to hold the wheel in place.

D. FUNCTION OF STAR WHEEL OF DAYS:

The function of this wheel is to register the day of the week on the dial. This wheel is automatically controlled by the calendar mechanism and is moved forward one tooth, each 24 hours, changing the day on the dial. This wheel can also be set manually to indicate the correct day on the dial. Once the day is set correctly on the dial, from then on it will be controlled automatically.

REMARKS:

When setting the calendar mechanism manually, it must be remembered, that peculiar to this mechanism, when setting the date wheel to indicate the correct date, the days wheel is moved forward at the same time. Hence, when correcting the date manually, such as at the end of each month having less than 31 days, the date wheel must first be moved forward to indicate the first day of the following month. This will cause the days wheel to indicate the incorrect day of the week and the days wheel must then be set manually to indicate the correct day.

REFERENCE: Day and date actuating detent is Assembly 14.
Days wheel jumper is Assembly 7.

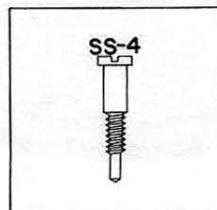

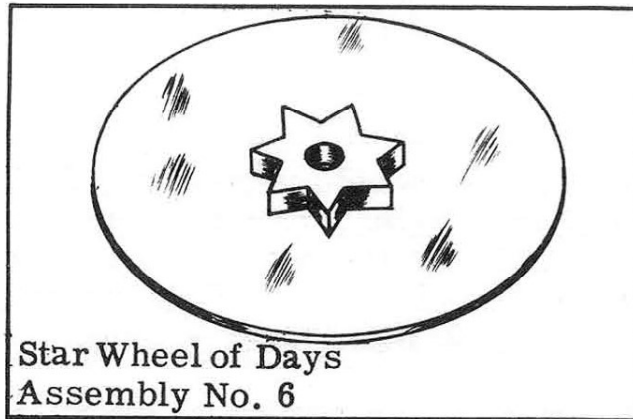

OILING

The shoulder of screw on which the star wheel of days pivots should be slightly moistened with oil.

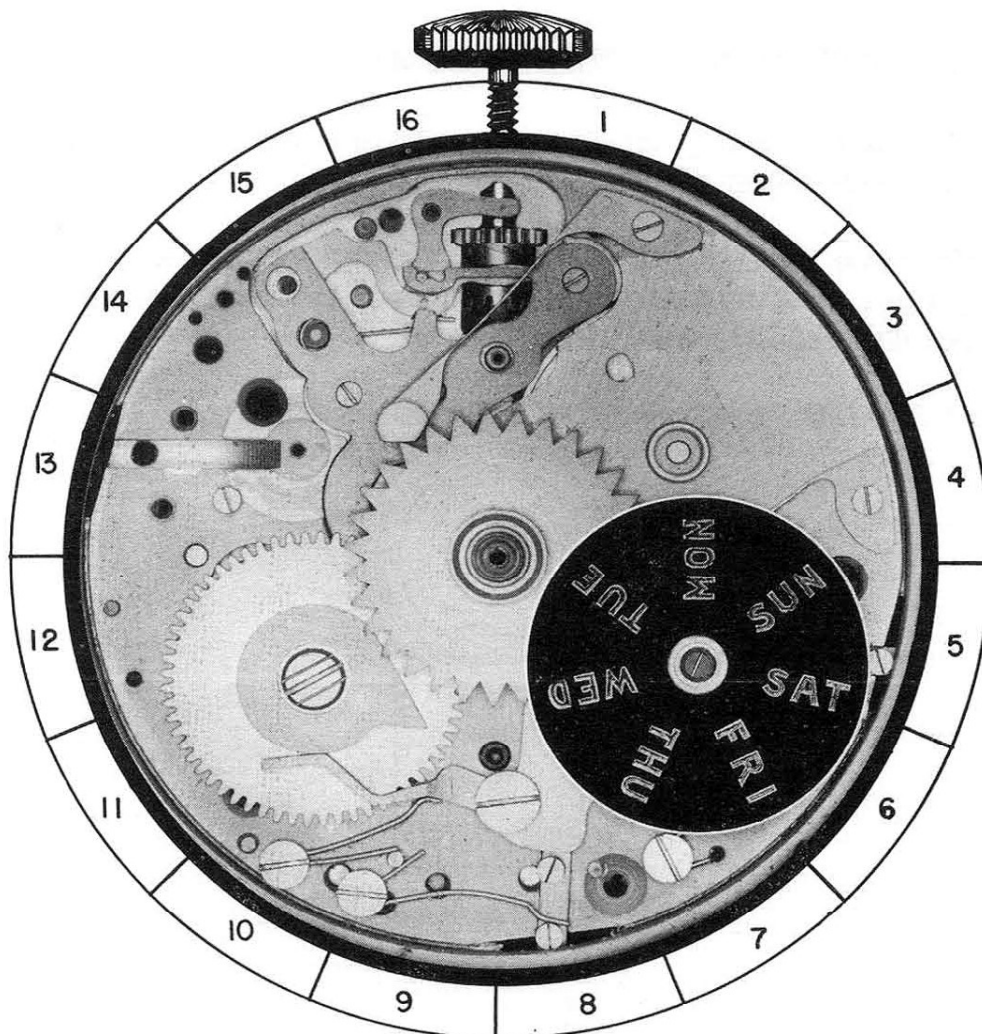

6-A

A. DISASSEMBLY PROCEDURE OF DAYS WHEEL JUMPER:

The days wheel jumper is held in position by fillister head screw FS-2, and steady pins. Remove screw and loosen the jumper from the plate by sliding a finely sharpened screwdriver between plate and jumper. When steady pins are free in plate, jumper may be lifted from movement.

(The shape of screw for this part is shown at bottom of page.)

B. ASSEMBLY PROCEDURE OF DAYS WHEEL JUMPER:

Place the jumper on the plate in the position shown in the photograph, with the steady pins over proper holes in plate. Now press jumper down flush on plate and replace fillister head screw FS-2 to hold it in position.

C. FUNCTIONS OF DAYS WHEEL JUMPER ARE:

1. The date wheel jumper correctly spaces the turning of the star wheel of days.
2. The end "A" of jumper holds the star wheel of days in proper position, so that a bump or jar cannot alter the position of this wheel.

REFERENCE: Star wheel of days is Assembly 6.

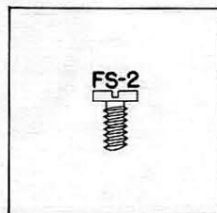

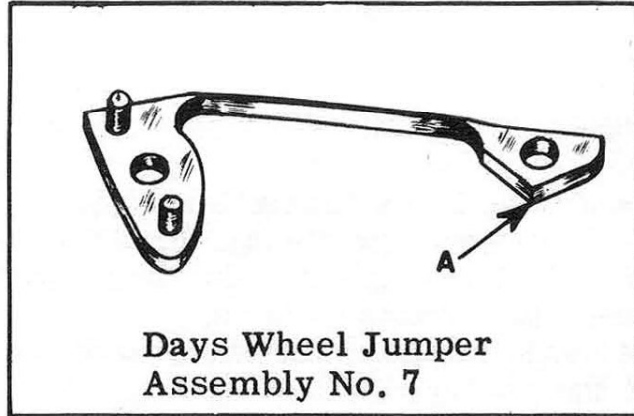

OILING

The days wheel jumper should not be oiled.

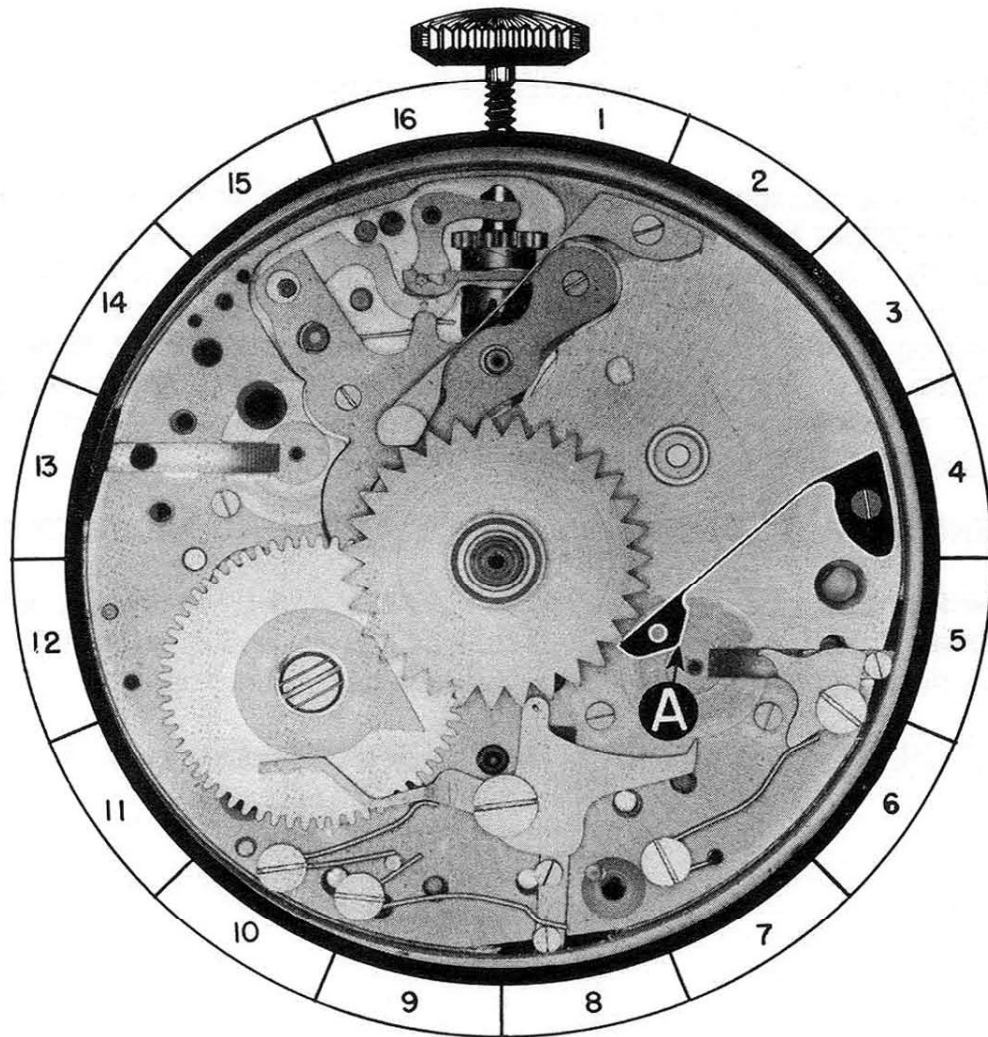

7-A

A. DISASSEMBLY PROCEDURE OF DAYS WHEEL SETTING DETENT SPRING:

The days wheel setting detent spring is held in place by shouldered screw SS-5. To remove the spring, loosen the screw and unhook the end "A" of spring from the days wheel setting detent. This will release the tension on the spring. After the tension on this spring has been released, the shouldered screw SS-5 can be removed and the spring lifted straight up. This will lift the end "B" of the spring from the hole in the plate.

(The shape of screw for this part is shown at bottom of page.)

B. HAZARDS IN DISASSEMBLY OF DAYS WHEEL SETTING DETENT SPRING:

Be sure the screw is loose enough so that you may lift the end "A" of spring without bending it.

C. ASSEMBLY PROCEDURE OF DAYS WHEEL SETTING DETENT SPRING:

Place the spring on the movement with the end "A" of spring in the position indicated by the dotted line in the photograph. The end "B" of spring should be down in the hole in the plate, and the loop in the spring should be over the proper screw hole. Now replace the shouldered screw, but before tightening this screw, lift the end "A" of spring and hook it on the days wheel setting detent, as shown in the photograph. The shouldered screw may now be tightened to hold the spring in place.

D. FUNCTION OF DAYS WHEEL SETTING DETENT SPRING:

The function of this spring is to hold the end "A" of days wheel setting detent towards the outside of watch, and to return it to this position after it has been pushed and released.

REFERENCE: Days wheel setting detent is Assembly 9.

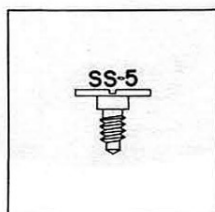

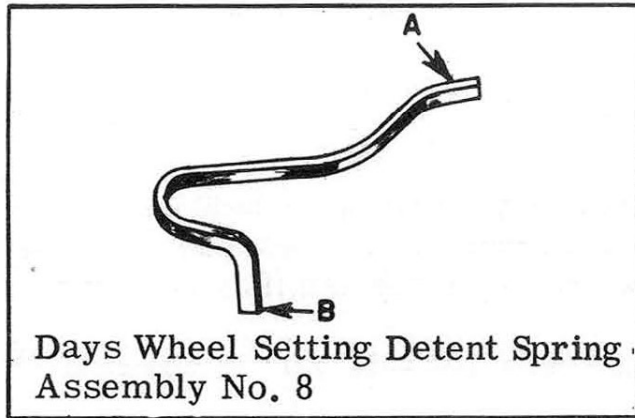

OILING

The end "A" of days wheel detent spring should be slightly moistened with oil at point of contact with days wheel setting detent.

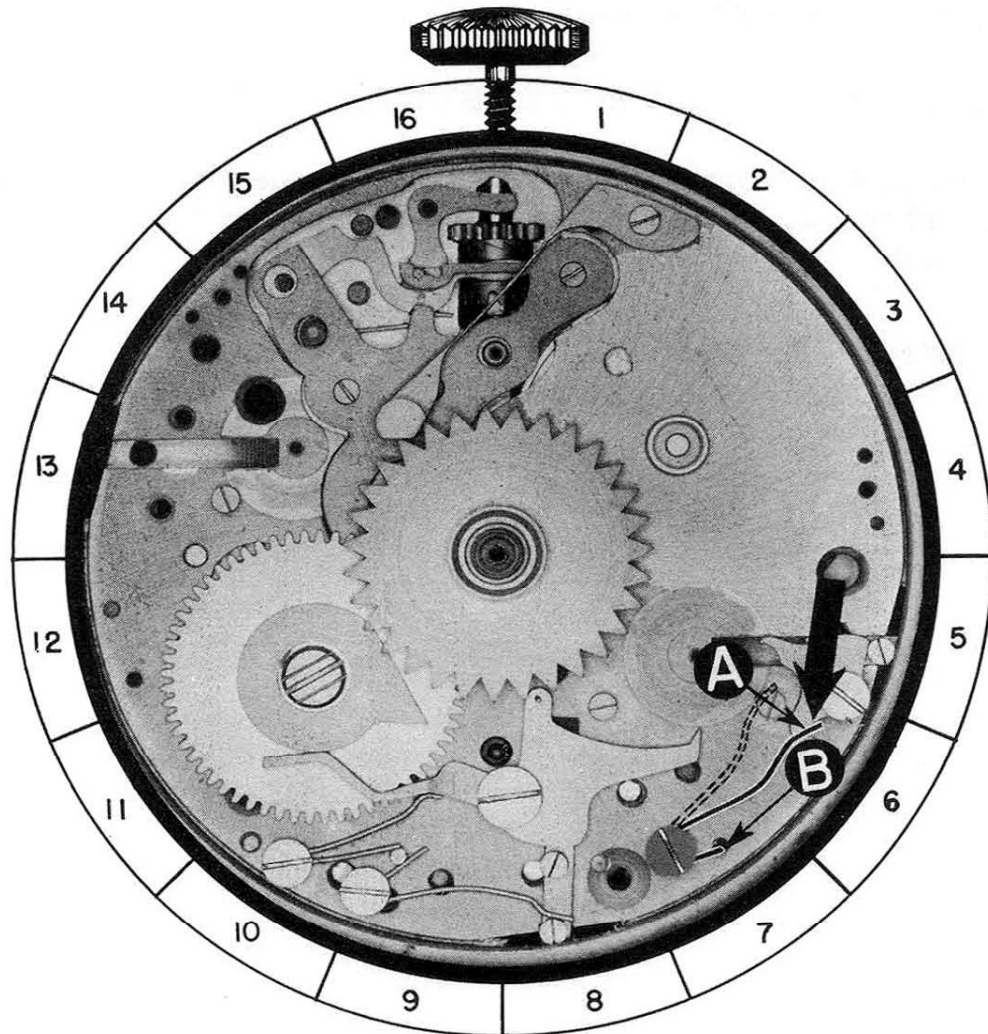

8-A

A. DISASSEMBLY PROCEDURE OF DAYS WHEEL SETTING DETENT:

The days wheel setting detent is held in position by shouldered screw SS-6, and pivots on this screw. Remove screw and detent will be free on plate and may be lifted from movement.

(The shape of screw for this part is shown at bottom of page.)

B. ASSEMBLY PROCEDURE OF DAYS WHEEL SETTING DETENT:

Place the detent on the plate, in the position shown in the photograph, with the hole in detent over the proper hole in the plate. With detent in this position, replace shouldered screw SS-6, to hold the detent in position. Detent should turn freely under head of screw.

C. FUNCTION OF DAYS WHEEL SETTING DETENT:

When pushed, this detent turns the star wheel of days, thus this wheel can be set manually to indicate the correct day on the dial.

REFERENCE: Star wheel of days is Assembly 6.

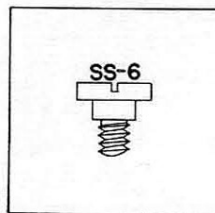

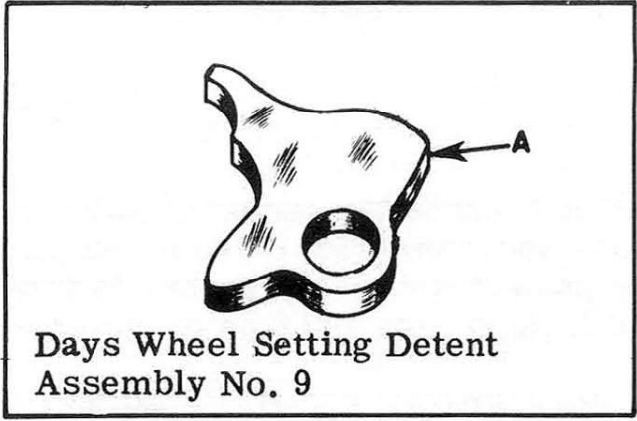

OILING
The shouldered screw on which the days wheel setting detent pivots should be slightly moistened with oil. The end "A" of detent should be slightly moistened with oil at point of contact with screwhead.

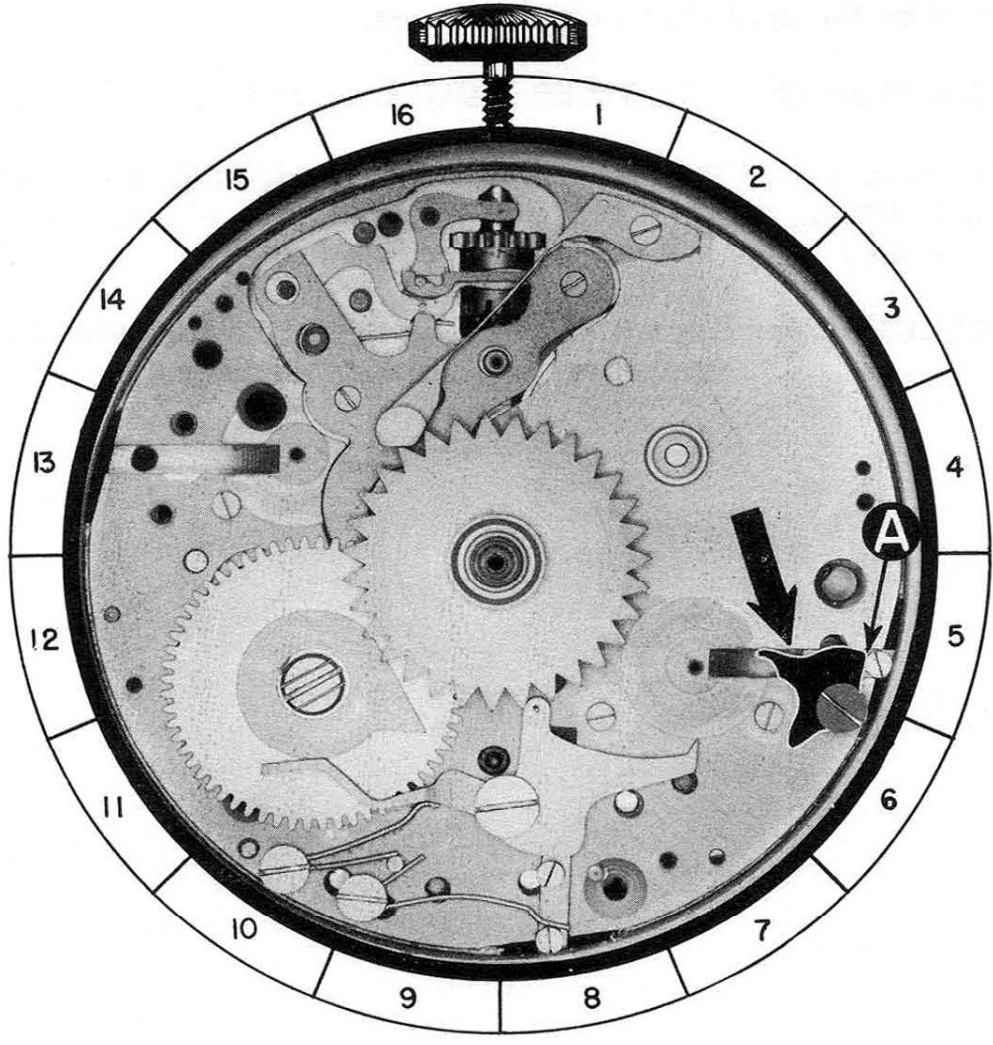

9-A

**A. DISASSEMBLY PROCEDURE OF DAYS WHEEL SETTING
PUSHER:**

Slide the pusher towards the center of watch until the end "A" of pusher has moved from under the case ring, which is indicated as "C" in the photograph. When pusher is free of ring, pusher may be lifted from recess and free of movement.

**B. ASSEMBLY PROCEDURE OF DAYS WHEEL SETTING
PUSHER:**

Place the pusher in the slot at the position shown in the photograph, with the end "A" of pusher towards the outside of watch. Now slide the pusher towards the outside of the watch until the end "A" of the pusher is under the case ring, and the screw head "B" is resting against the ring. This part will be held in place by the next part to be replaced.

C. FUNCTION OF THE DAYS WHEEL SETTING PUSHER:

The function of this pusher when pushed, is to move the days wheel setting detent which will turn the days wheel. This makes it possible to set the day of the week manually.

REFERENCE: Days wheel setting detent is Assembly 9.
Star wheel of days is Assembly 6.

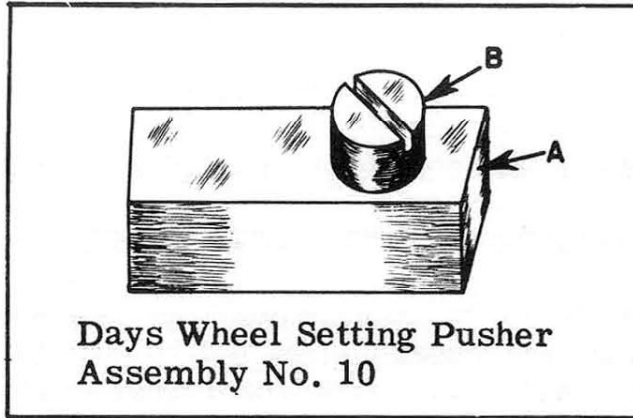

OILING

The surfaces of the days wheel setting pusher that contact the plate should be moistened with oil.

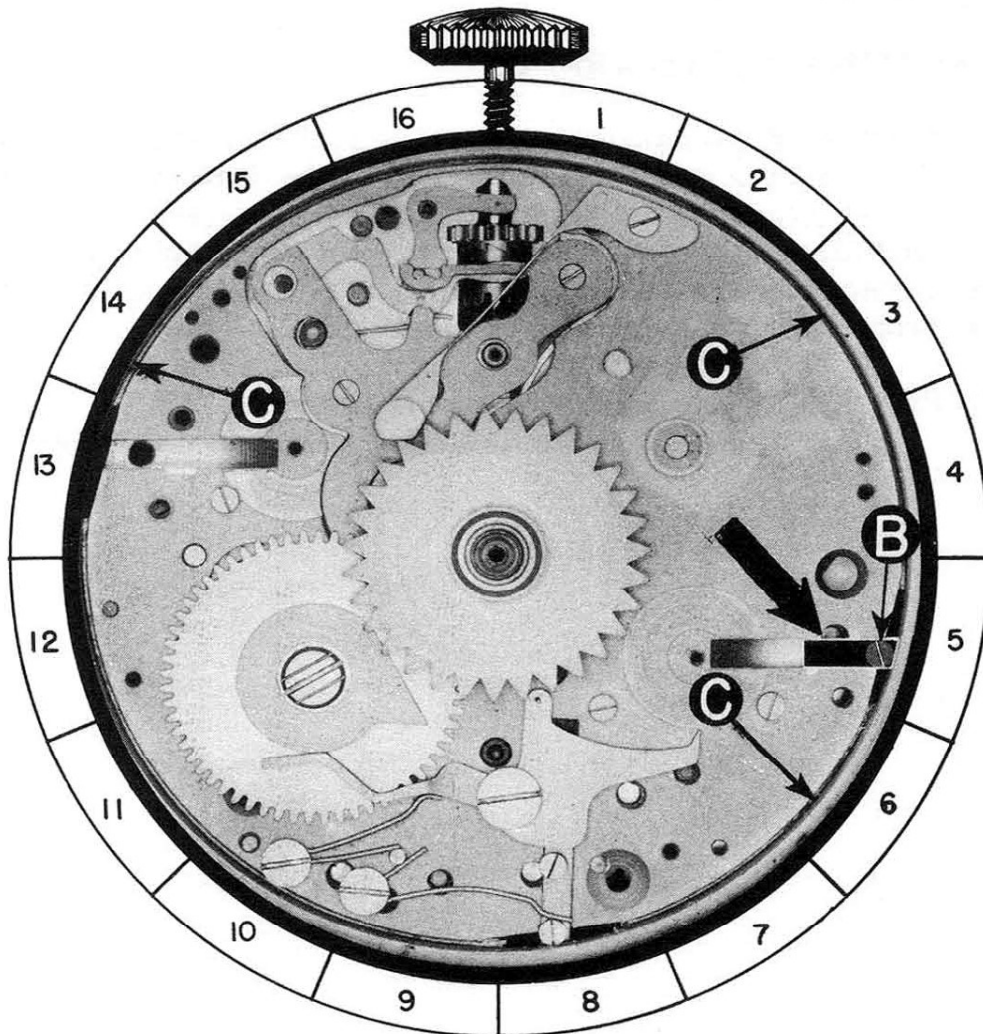

10-A

A. DISASSEMBLY PROCEDURE OF DATE WHEEL:

The date wheel is simply lifted out of place to remove it.

B. ASSEMBLY PROCEDURE OF DATE WHEEL:

Place the date wheel in position over the hour wheel and move the end "A" of date wheel jumper out slightly to clear the teeth on this wheel. Then push wheel down in position. Date wheel jumper can now be released so the end "A" of jumper meshes with date wheel teeth.

C. HAZARDS IN ASSEMBLY OF DATE WHEEL:

When pressing the date wheel down in position, be sure the pin "B" on day and date actuating detent is not under one of the teeth on date wheel.

D. FUNCTION OF DATE WHEEL:

The function of the date wheel is to indicate the date on the dial. This is done by a hand being attached to the date wheel. The date wheel is controlled automatically by the calendar mechanism, and also controlled manually to enable the operator to set the correct date on the dial. After it is set to the correct date, it is from then on controlled automatically.

REFERENCE: Date wheel jumper is Assembly 12.
Day and date actuating detent is Assembly 14.

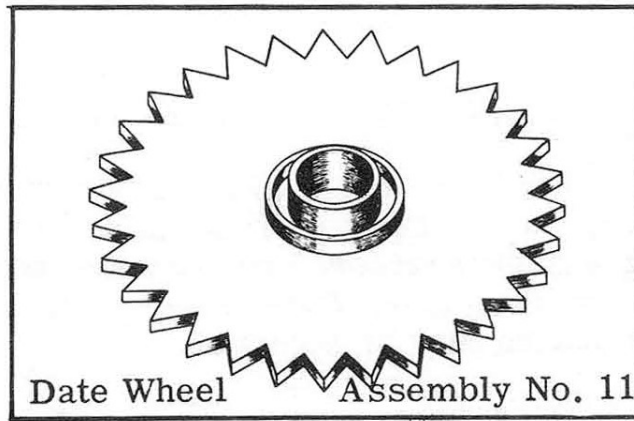

OILING

The date wheel should not be oiled.

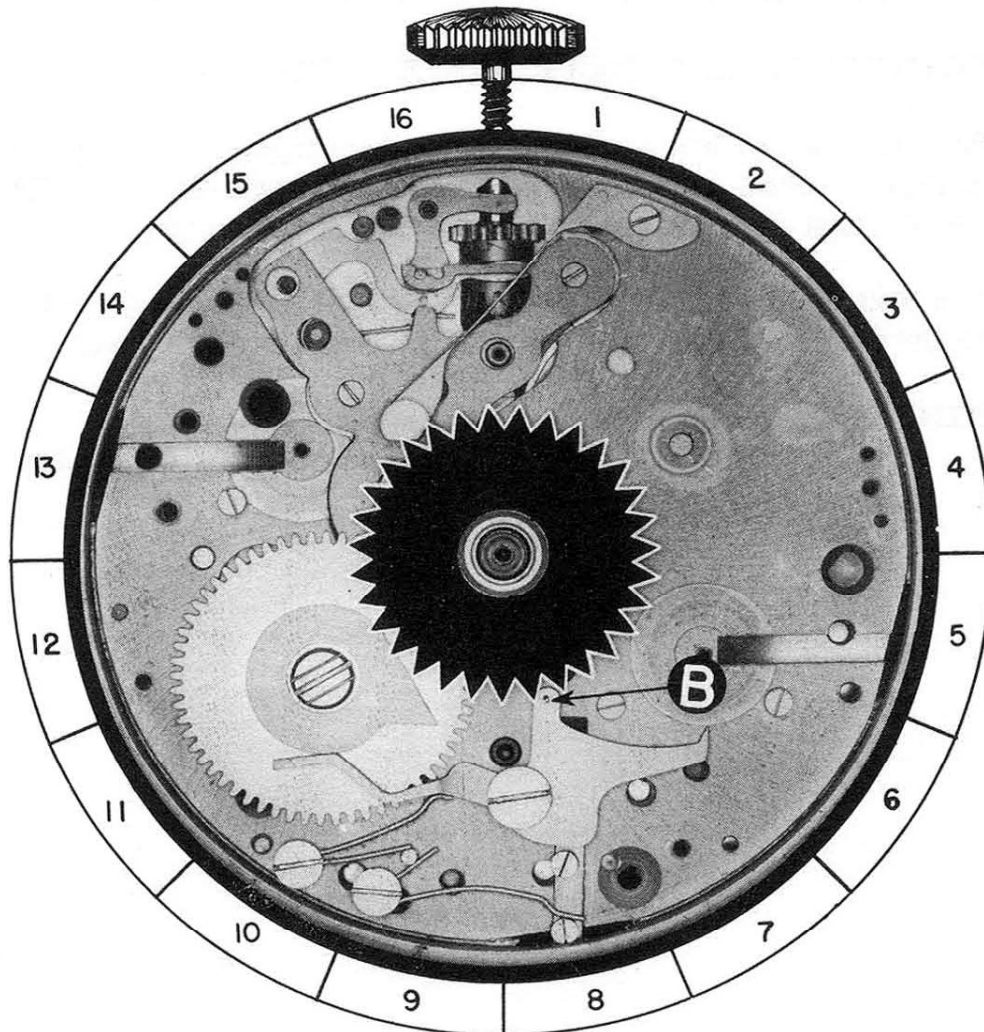

11-A

A. DISASSEMBLY PROCEDURE OF DATE WHEEL JUMPER:

The date wheel jumper is held in place by fillister head screw FS-3, and steady pins. Remove screw and loosen jumper from plate by sliding a finely sharpened screwdriver between the base of the spring and the plate. When steady pins are free in the movement, the spring may be removed.

(The shape of screw for this part is shown at bottom of page.)

B. ASSEMBLY PROCEDURE OF DATE WHEEL JUMPER:

Place the jumper on the movement in the position shown in the photograph, with the steady pins over the proper holes in the plate. Now press the spring down flush on the plate, and replace fillister head screw FS-3, to hold the jumper in position.

C. FUNCTIONS OF THE DATE WHEEL JUMPER ARE:

1. The end "A" of jumper spaces the turning of the date wheel so that it turns exactly one tooth each time the pin "B" on the day and date actuating detent turns the wheel.
2. The end "A" of jumper holds a tension on the date wheel so that a bump cannot alter the position of the wheel.

REFERENCE: Date wheel is Assembly 11.
Day and date actuating detent is Assembly 14.

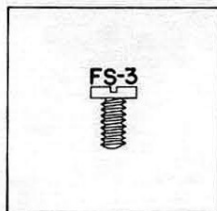

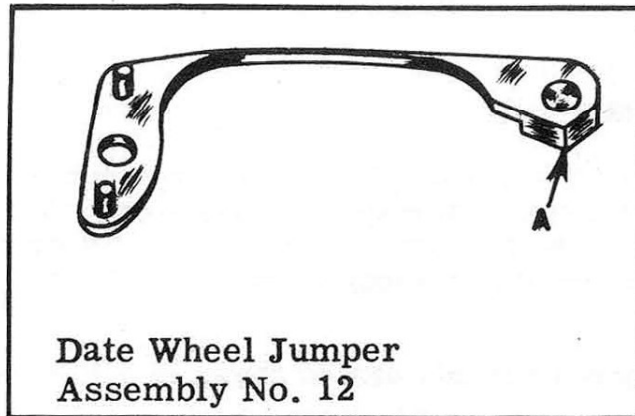

OILING

The date wheel jumper should not be oiled.

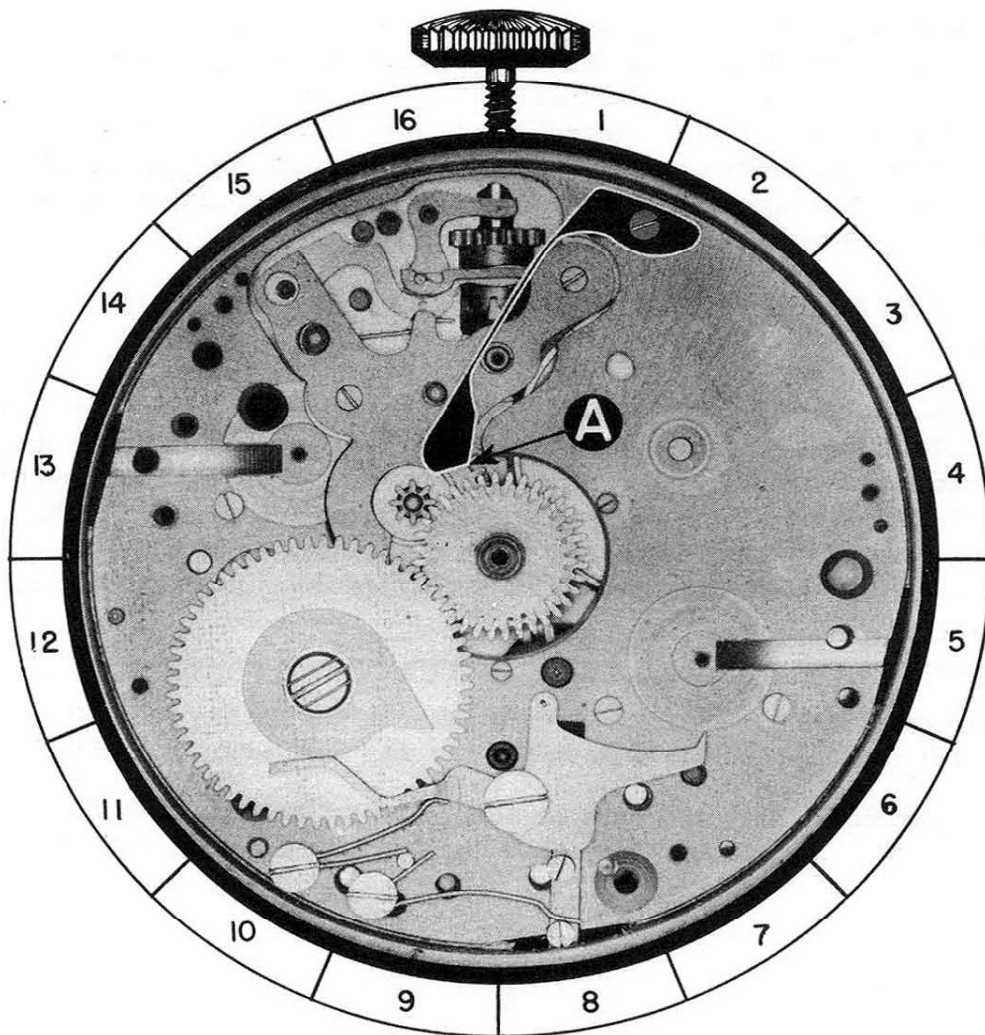

12-A

A. DISASSEMBLY PROCEDURE OF DAY AND DATE ACTUATING DETENT SPRING:

This spring is held in place by shouldered screw SS-7. To remove spring, loosen the screw slightly and unhook end "A" of spring from the day and date actuating detent lever. This will release the tension on spring. Now remove shouldered screw and lift the spring from movement.

(The shape of screw for this part is shown at bottom of page.)

B. HAZARDS IN DISASSEMBLY OF DAY AND DATE ACTUATING DETENT SPRING:

Be sure this screw is loosened enough so that end "A" of spring may be lifted above the actuating detent without bending spring.

C. ASSEMBLY PROCEDURE OF DAY AND DATE ACTUATING DETENT SPRING:

Place the spring on the movement, with the loop in the spring over the proper screw hole, and the end "B" of the spring contacting the post "C" on the plate. The end "A" of the spring should be in the position indicated by the dotted line in the photograph. Now replace the screw, but before tightening it, place the end "A" of the spring in the position shown on the photograph. The shouldered screw may now be tightened to hold the spring in place.

D. HAZARDS IN ASSEMBLY OF DAY AND DATE ACTUATING DETENT SPRING:

In order to have the least tension possible on the day and date actuating detent spring when replacing it in the movement, turn the day and date actuating wheel to a position so that the beak "A" on this wheel is not contacting the day and date actuating detent. If the beak of the cam is forcing the detent toward the outside of the movement, there will be more tension on the spring, making it more difficult to replace.

E. FUNCTION OF DAY AND DATE ACTUATING DETENT SPRING:

Function of this spring is to hold the end "A" of the day and date actuating lever in contact with the cam on the day and date actuating wheel.

REFERENCE: Day and date actuating detent is Assembly 14.
Day and date actuating wheel and cam is Assembly 17.

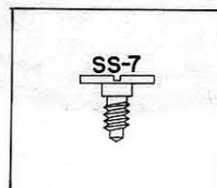

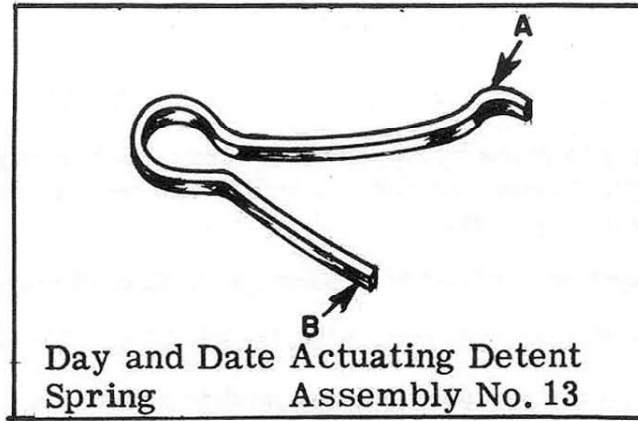

OILING

The end "A" of spring should be slightly moistened with oil at point of contact with actuating detent lever.

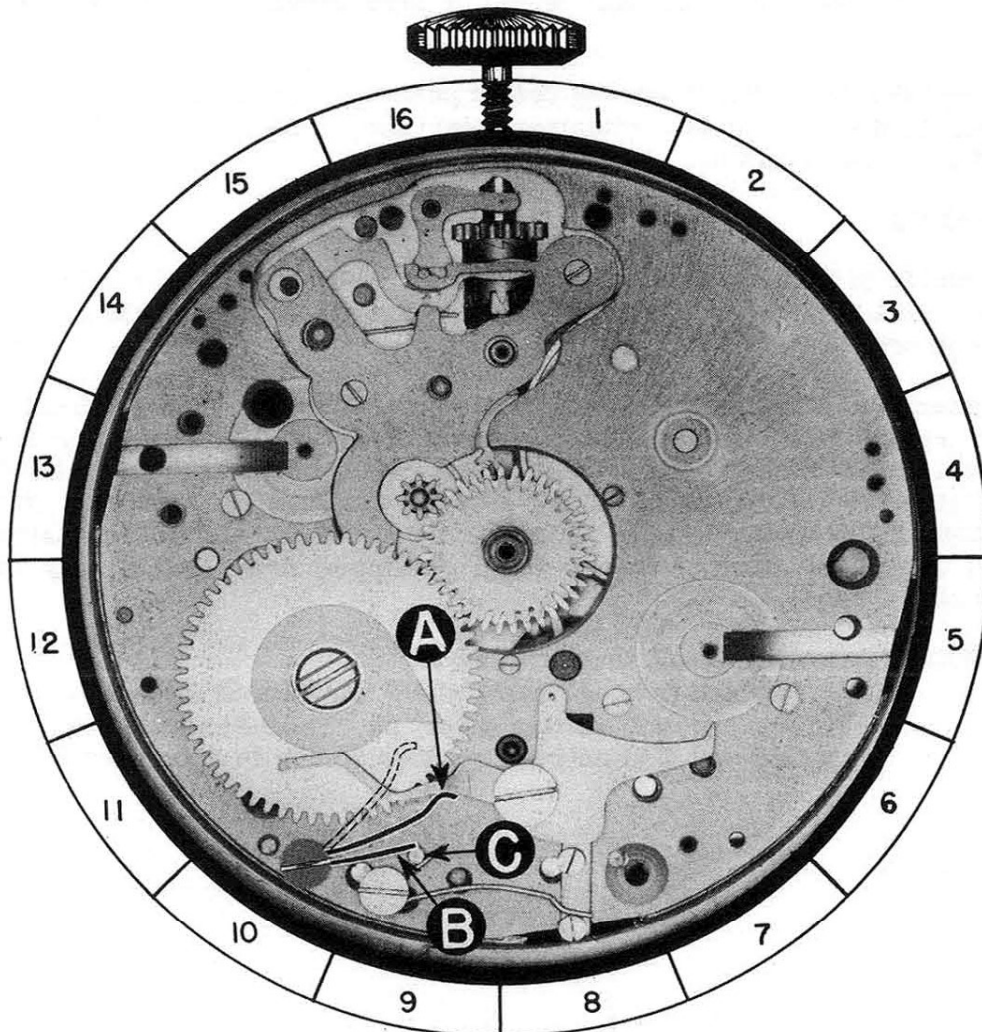

A. DISASSEMBLY PROCEDURE OF DAY AND DATE ACTUATING DETENT:

This detent is held in place by shouldered screw SS-8, and pivots on this screw. Remove shouldered screw and detent will be free on plate, and may be lifted from movement.

(The shape of screw for this part is shown at bottom of page.)

B. ASSEMBLY PROCEDURE OF DAY AND DATE ACTUATING DETENT:

Place the detent on the movement in the position shown in the photograph, with the part "A" of detent contacting the cam on the day and date actuating wheel, and the hole in the detent over the proper hole in the plate. With the detent in this position, replace shouldered screw SS-8 to hold the detent in position. The detent should pivot freely under the head of this screw.

C. FUNCTIONS OF THE DAY AND DATE ACTUATING DETENT ARE:

1. When moved automatically by the calendar mechanism, this detent moves the date wheel and the star wheel of days forward one tooth each 24 hours.
2. When the day and date setting detent pusher is pushed and released manually, the day and date actuating detent moves the date wheel and star wheel of days forward one tooth.

REMARKS:

Any spring in the chronograph or date mechanism should not hold any more tension on a part or be any stronger than is necessary, to cause the part to function properly.

For example: The day and date actuating detent spring should not hold any more tension on the day and date actuating detent than is necessary to cause this part to function properly. Any excess tension that this spring holds on this detent will cause more friction between the detent and the cam on the day and date actuating wheel. This will cause the day and date actuating wheel to be unnecessarily hard to turn, causing an unnecessary drag on the train of the watch.

REFERENCE: Date wheel is Assembly 11.
Day and date actuating wheel and cam is Assembly 17.
Day and date setting detent pusher is Assembly 16.
Day and date actuating detent spring is Assembly 13.

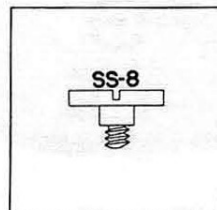

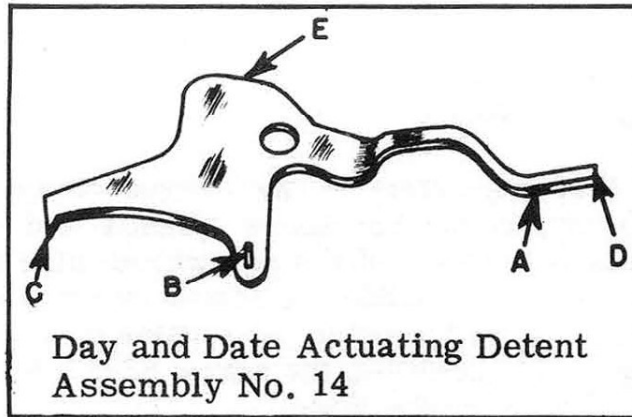

OILING

The day and date actuating detent should be slightly moistened with oil at the following points:

1. The shoulder of the screw on which the detent pivots.
2. End "A" of detent at point of contact with cam on day and date actuating wheel.
3. End "E" at point of contact with screw in setting detent pusher.

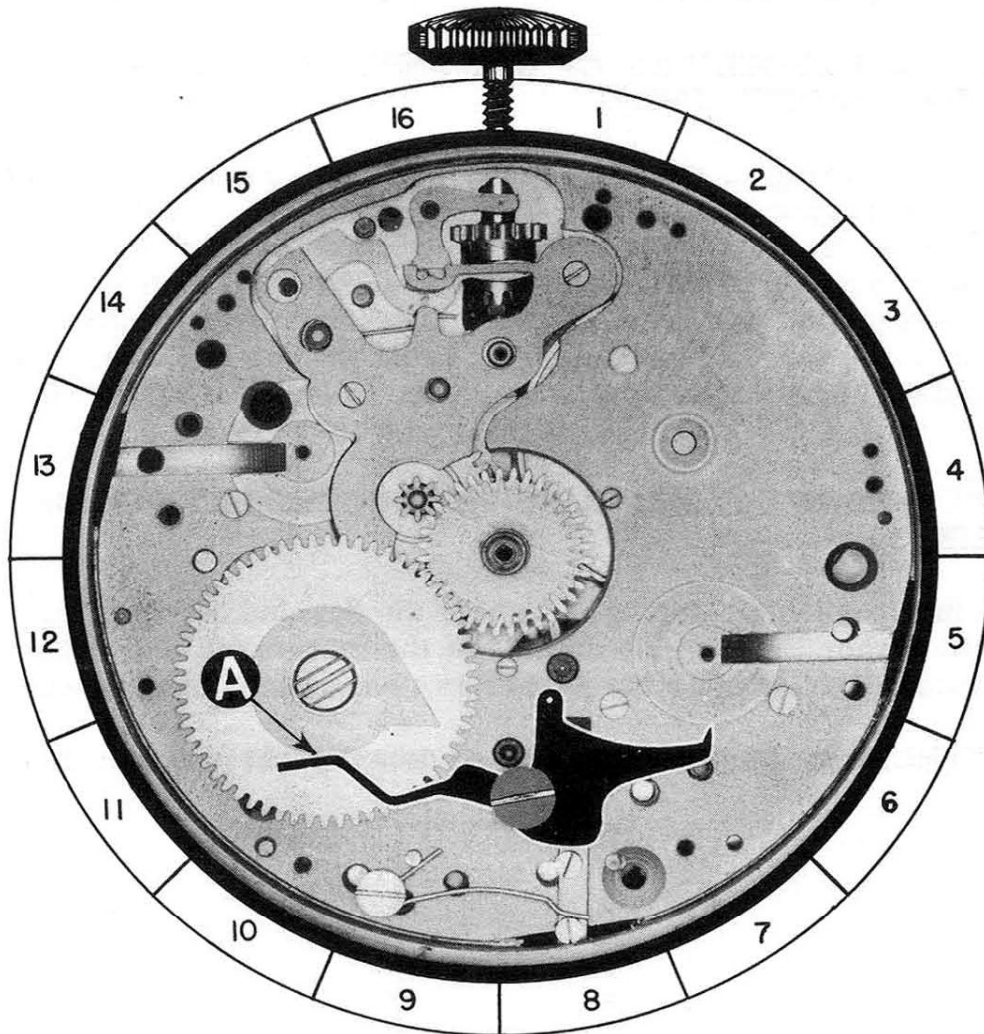

14-A

**A. DISASSEMBLY PROCEDURE OF DAY AND DATE SETTING
DETENT PUSHER SPRING:**

This spring is held in position by shouldered screw SS-9. To remove the spring, loosen the screw slightly and lift the end "A" of spring above the level of the screwhead, placing the end "A" of the spring in the position indicated by the dotted line in the photograph. This will release the tension on the spring. With the spring in this position, the screw SS-9 may be removed and the spring lifted from the plate.

(The shape of screw for this part is shown at bottom of page.)

**B. HAZARDS IN DISASSEMBLY OF DAY AND DATE SETTING
DETENT PUSHER SPRING:**

Be sure that the screw is loosened enough so that end "A" of spring may be lifted above screwhead, without bending spring.

**C. ASSEMBLY PROCEDURE OF DAY AND DATE SETTING
DETENT PUSHER SPRING:**

Place the spring on the movement, with the loop in the spring over the proper screw hole, and the end "B" of the spring contacting the post "C" on the plate. The end "C" of the spring should be in the position indicated by the dotted line in the photograph. Now replace the screw, but before tightening it, place the end "A" of the spring in its proper position. The shouldered screw may now be tightened to hold the spring in place.

**D. FUNCTION OF DAY AND DATE SETTING DETENT PUSHER
SPRING:**

The function of this spring is to hold the day and date setting detent pusher towards the outside of the movement, and return it to this position after the pusher has been pushed and released.

REFERENCE: Day and date setting detent pusher is Assembly 16.

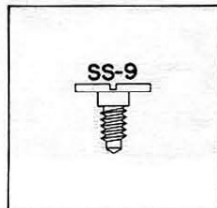

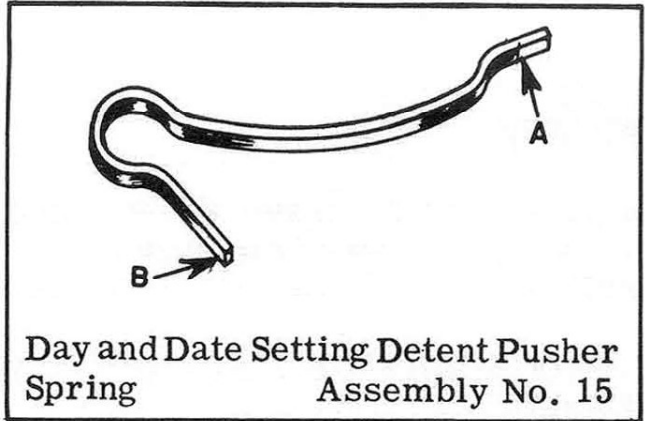

OILING

The part "A" of this spring should be slightly moistened with oil at point of contact with screw head on day and date setting detent pusher.

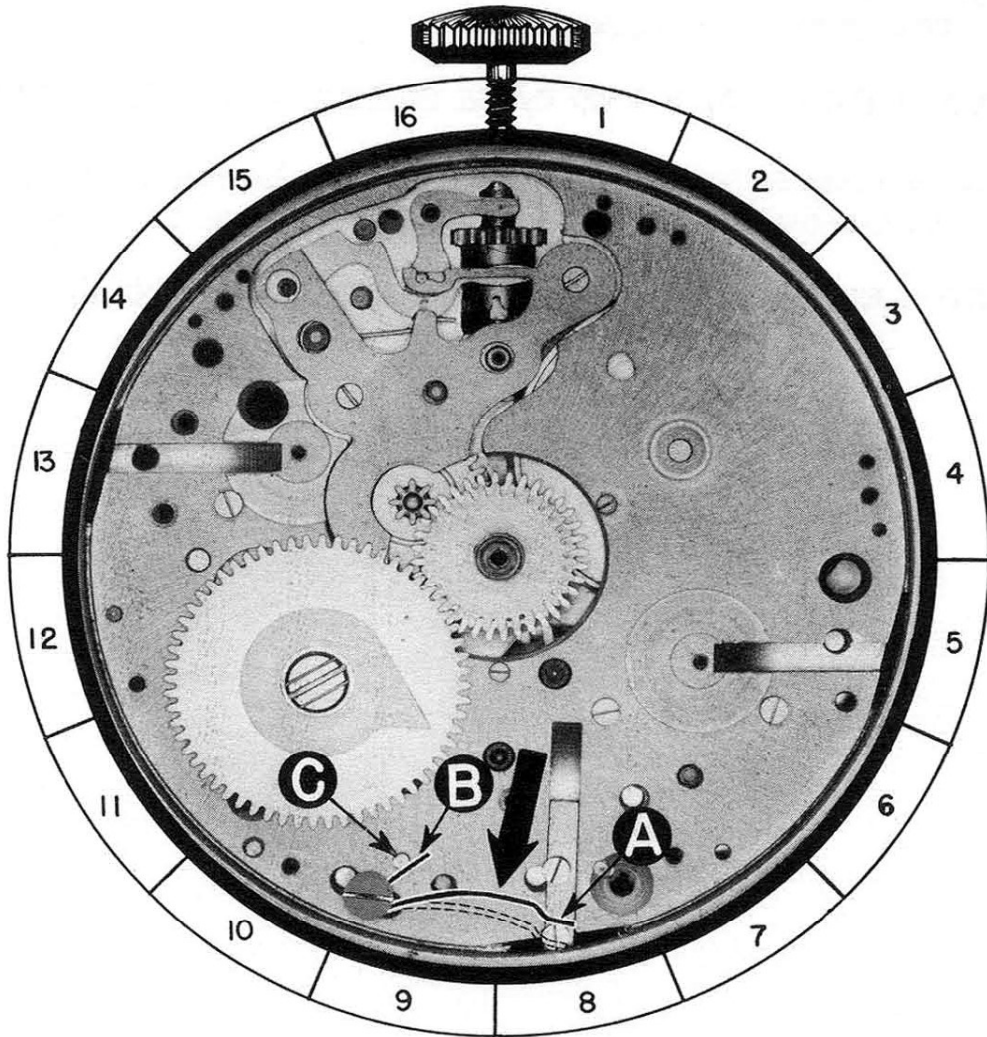

15-A

**A. DISASSEMBLY PROCEDURE OF DAY AND DATE SETTING
DETENT PUSHER:**

Slide the pusher toward the center of the watch until the end "A" of the pusher has moved from underneath the case ring, which is identified by the letter "C" in the photograph.

**B. ASSEMBLY PROCEDURE OF DAY AND DATE SETTING
DETENT PUSHER:**

Place the pusher in the slot in the plate at the position shown in the photograph, with the end "A" of the pusher toward the outside of the watch. Now slide the pusher toward the outside of the watch until the end "A" of the pusher is underneath the case ring and the screw head "B" on the pusher is resting against the case ring. This part will be held in place by the next part to be replaced.

C. FUNCTION OF DAY AND DATE SETTING DETENT PUSHER:

The function of this pusher when pushed, is to move the day and date actuating detent to change the day and date manually.

REFERENCE: Day and date actuating detent is Assembly 14.

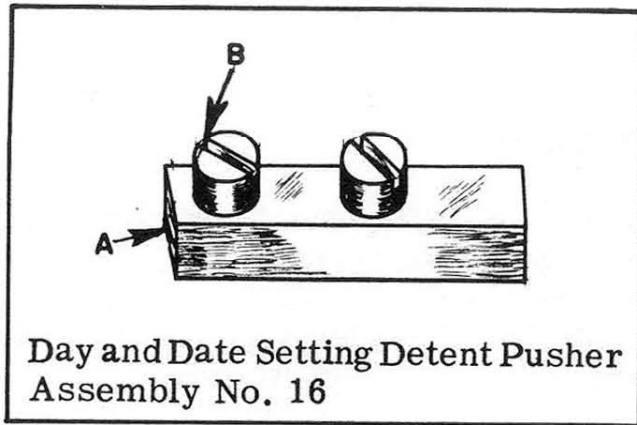

OILING

The surfaces of the day and date setting detent pusher that contact the plate should be moistened with oil.

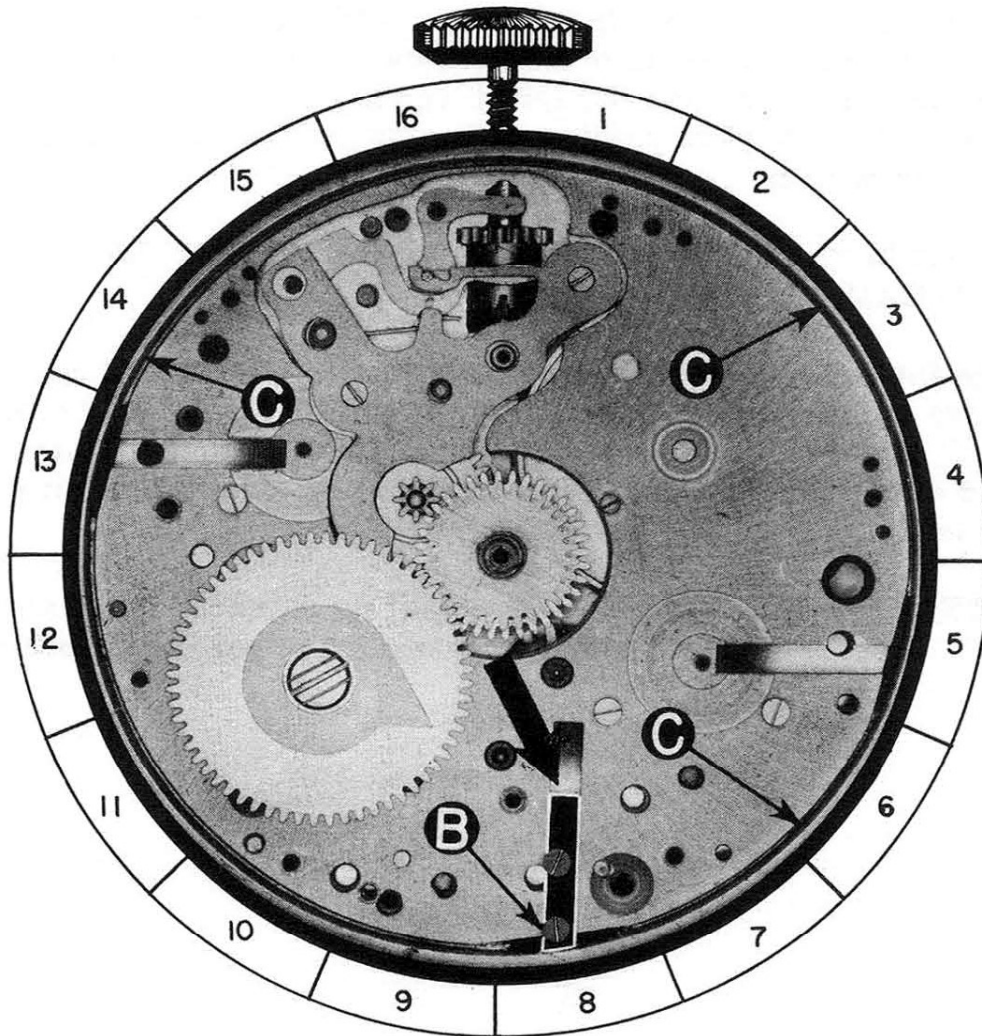

16-A

A. DISASSEMBLY PROCEDURE OF DAY AND DATE ACTUATING WHEEL AND CAM:

The day and date actuating wheel and cam is held in place by left-threaded shouldered screw SS-10. Remove the screw and the wheel will be free on the plate and may be lifted from the movement. The left-threaded screw may be identified by the two lines parallel with the screw slot.

(The shape of screw for this part is shown at bottom of page.)

B. ASSEMBLY PROCEDURE OF DAY AND DATE ACTUATING WHEEL AND CAM:

Place the day and date actuating wheel in the position shown in the photograph, with the hole in the center of the wheel over the proper screw hole in the plate, and the teeth of this wheel meshing with the teeth of the hairing wheel. With the wheel in this position, replace the left-threaded shouldered screw SS-10 to hold the wheel in position. The wheel should not bind under the screw head.

C. FUNCTION OF THE DAY AND DATE ACTUATING WHEEL AND CAM:

The function of the day and date actuating wheel and cam is to move the day and date actuating detent by means of the beak "A" of the cam. This occurs once each 24 hours, as the day and date actuating wheel and cam makes one revolution each 24 hours.

REFERENCE: Day and date actuating detent is Assembly 14.
Hour wheel with hairing wheel is Assembly 18.

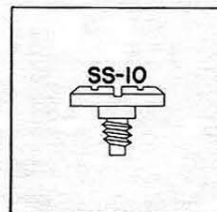

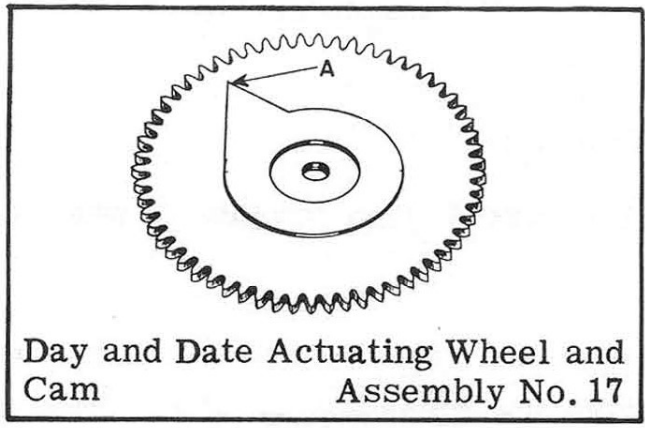

OILING

The shoulder of screw on which the actuating wheel pivots should be slightly moistened with oil.

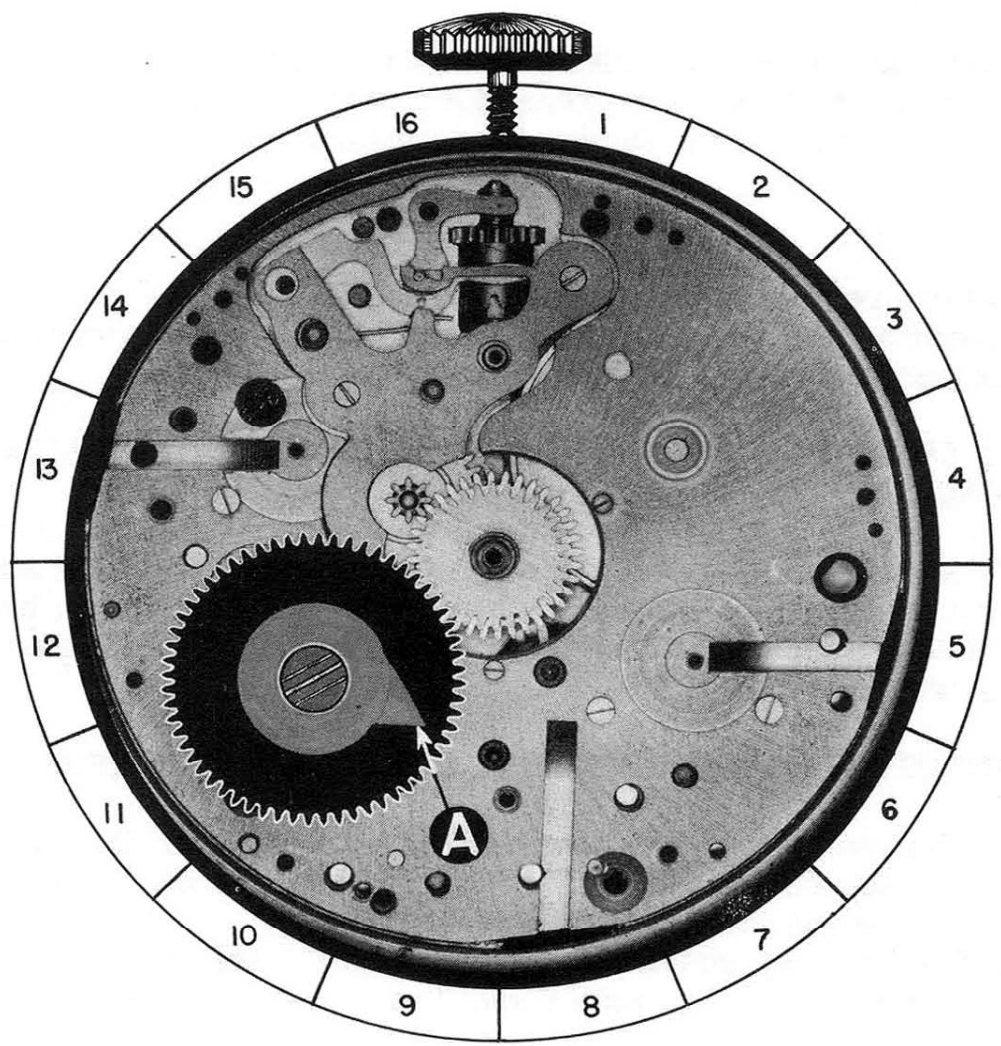

17-A

A. DISASSEMBLY PROCEDURE OF HOUR WHEEL WITH HAIRING WHEEL:

To remove this wheel, grip the tube of wheel and lift straight up.

NOTE:

This completes the disassembly of the date mechanism. It is not necessary to remove the case ring, identified by the letter "C" in the photograph. Now turn the movement over and continue to disassemble the train side, following the instructions in this book.

B. ASSEMBLY PROCEDURE OF HOUR WHEEL WITH HAIRING WHEEL:

Place the wheel in position over the cannon pinion, as shown in the photograph and press down until the teeth in the hour wheel mesh with the leaves in the minute wheel pinion.

NOTE:

Before replacing the parts on the dial side, the case ring, identified by the letter "C", must be on the movement in the position shown in the photograph.

C. HAZARDS IN ASSEMBLY OF HOUR WHEEL WITH HAIRING WHEEL:

This wheel should not fit tightly on the cannon pinion, but should turn freely on this pinion. When replacing hour wheel, be sure it is down far enough for the teeth to mesh with leaves on minute wheel pinion.

D. FUNCTIONS OF HOUR WHEEL WITH HAIRING WHEEL ARE:

1. The function of the hour wheel is to register the hour of the day on the dial of the watch; this is done by a hand attached to the hour wheel.
2. The hairing wheel "A" on the hour wheel transmits the power from the minute wheel to the calendar mechanism.

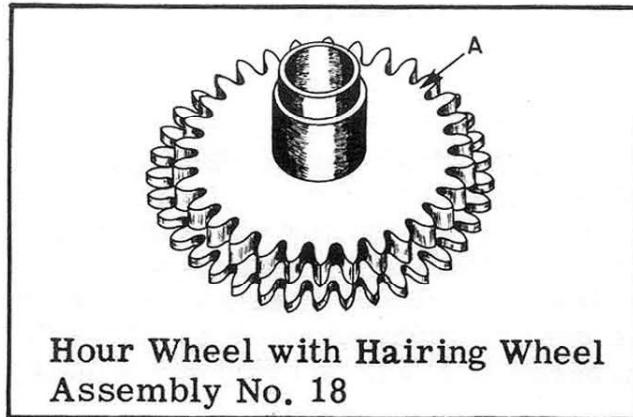

OILING

The hour wheel with hairing wheel should not be oiled.

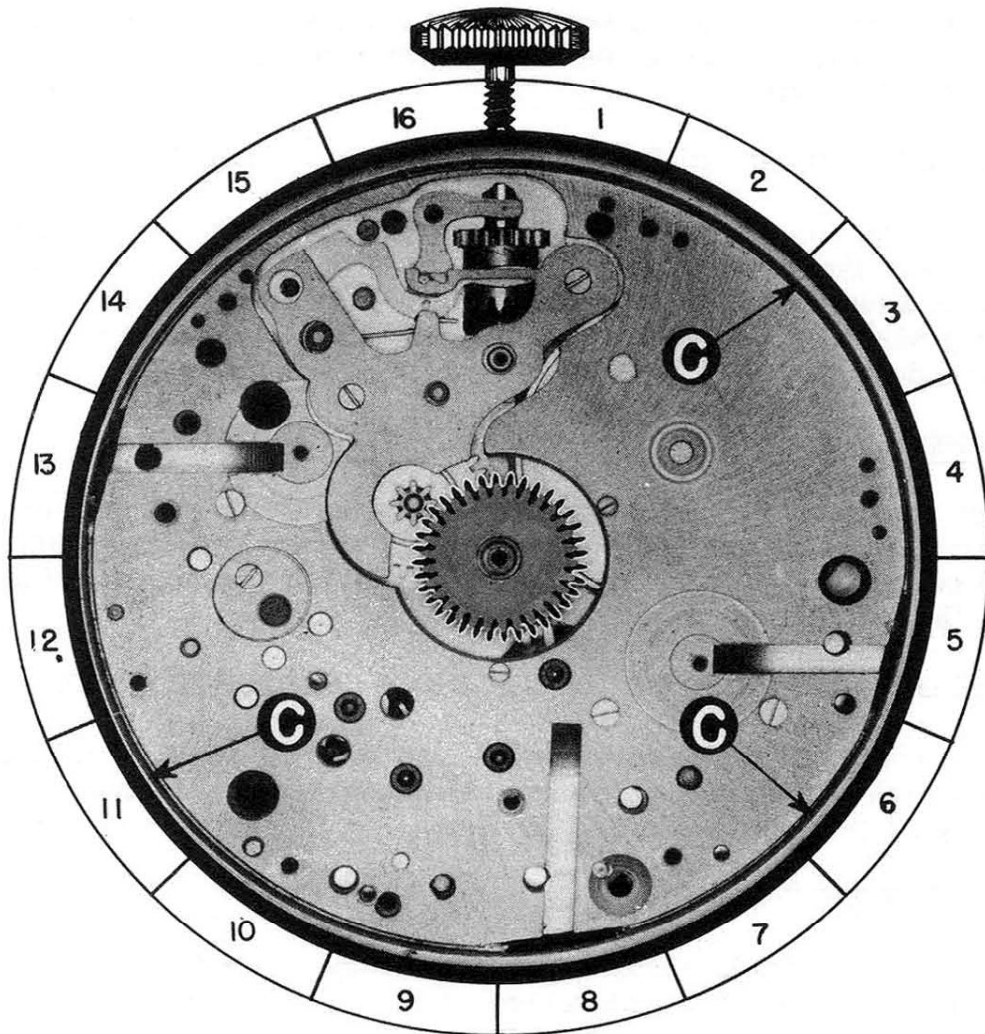

18-A

A. DISASSEMBLY PROCEDURE OF WHEEL OVER FOURTH WHEEL:

The wheel over fourth wheel fits friction tight on long pivot of the fourth wheel pinion. This wheel should be removed with a sweep wheel remover, but can be removed with two small thin-edged screwdrivers. The screwdrivers are placed opposite each other under hub "A" of wheel. One screwdriver is turned clockwise, while the other screwdriver is turned counter-clockwise. This will loosen the wheel from the pivot, permitting it to be lifted out of place.

B. HAZARDS IN DISASSEMBLY OF WHEEL OVER FOURTH WHEEL:

The wheel over fourth wheel fits over the very thin, long pivot of the fourth wheel pinion. This pivot, as you know, is very delicate, and easily bent or broken. The main reason why we selected this part to be one of the first parts to be removed from the chronograph mechanism, was to lessen the hazards of bending the long pivot on the fourth wheel pinion when removing the other parts of the chronograph mechanism. If the sweep wheel remover is held perfectly upright in removing wheel, the hazard of bending the fourth wheel pivot will be eliminated.

C. ASSEMBLY PROCEDURE OF WHEEL OVER FOURTH WHEEL:

This wheel fits over the long pivot of the fourth wheel, and should be placed on the pivot with hub "A" of wheel down. The wheel over fourth wheel should be staked down until it is level with the intermediary wheel. A hollow flat-faced punch should be used to stake the wheel down.

NOTE:

This completes the assembly of the chronograph mechanism on the train side. Now turn the movement over and continue to assemble the calendar mechanism on the dial side of the chronograph, following the instructions in this book.

D. HAZARDS IN ASSEMBLY OF WHEEL OVER FOURTH WHEEL:

Use care in staking down this wheel, so that you do not bend or break the fourth wheel pivot. If movement is held level, the hazards in replacing this wheel will be eliminated.

E. FUNCTION OF WHEEL OVER FOURTH WHEEL:

The function of this wheel is to transmit the power from the train of the watch to the chronograph mechanism. This wheel continues to turn as long as the watch is running.

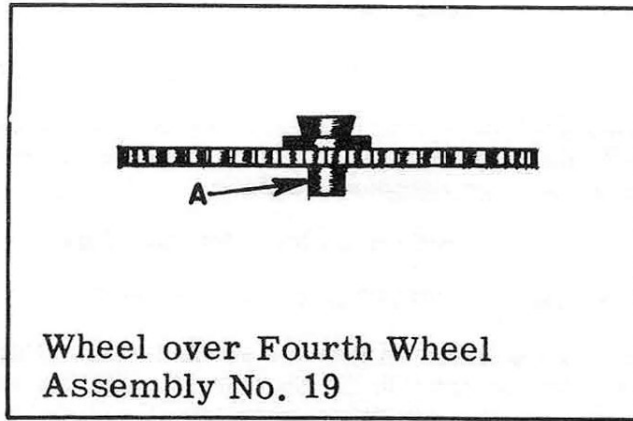

OILING

The wheel over fourth wheel should not be oiled.



19-A

A. DISASSEMBLY PROCEDURE OF MINUTE REGISTER PAWL:

The minute register pawl is held to the seconds wheel and minute register wheel bridge by fillister head screw FS-4. Remove screw and pawl will be free from bridge and may be lifted out of place.

(The shape of screw for this part is shown at bottom of page.)

B. ASSEMBLY PROCEDURE OF MINUTE REGISTER PAWL:

Hold the movement in a position so that the pendant is up. Place the minute register pawl in the position shown in the photograph, with the end "A" of the pawl between two teeth of the minute register wheel, and the hole in end "B" of the pawl centered over the screw hole in the end "A" of the seconds wheel and minute register wheel bridge. Now replace fillister head screw FS-4 to hold the pawl in position.

C. HAZARDS IN ASSEMBLY OF MINUTE REGISTER PAWL:

Handle the pawl very carefully when replacing, as it is very easily damaged. The end "A" of the pawl must be highly polished, as any pits of rust at this location may cause the pawl not to function properly.

D. ADJUSTING THE MINUTE REGISTER PAWL:

After replacing the pawl, push the push piece for setting back to zero until the flyback lever returns the minute register wheel to a zero position. With the flyback lever holding the wheel at a zero position, loosen the fillister head screw FS-4 that holds the pawl in position, and adjust the pawl so that the end "A" of the pawl is centered between two teeth of the minute register wheel. Now tighten the screw FS-4 to hold the pawl in position and check to see that the tightening of the screw has not turned the pawl, causing it to bind on the crown wheel. The tension of the minute register pawl on the minute register wheel must be very light, as a strong tension causes the wheel to be unnecessarily hard to turn. Still, the tension must be strong enough for the pawl to function properly, as described below. More detailed instructions for adjusting the minute register pawl will be found in volume twenty-four of the Esembl-O-Graf Library.

E. FUNCTIONS OF THE MINUTE REGISTER PAWL:

1. It correctly spaces the turning of the minute register wheel so that the wheel moves exactly one tooth each minute.
2. It holds the minute register wheel in a stationary position so that a bump does not alter the position of this wheel.

REFERENCE: Minute register wheel is Assembly 33.
Seconds wheel and minute register wheel bridge is Assembly 32.
Flyback lever is Assembly 28.

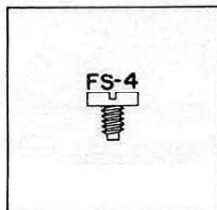

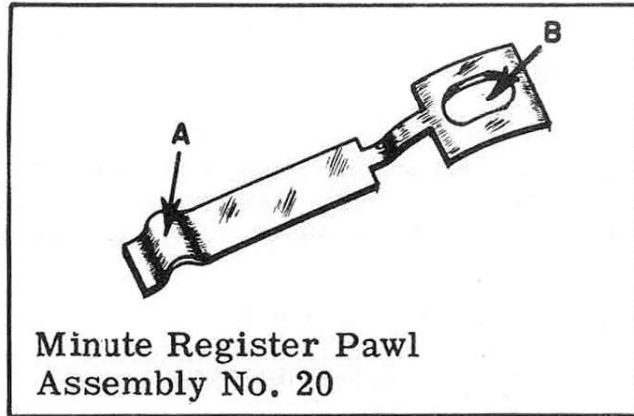

Minute Register Pawl
Assembly No. 20

OILING

The minute register pawl should not be oiled.

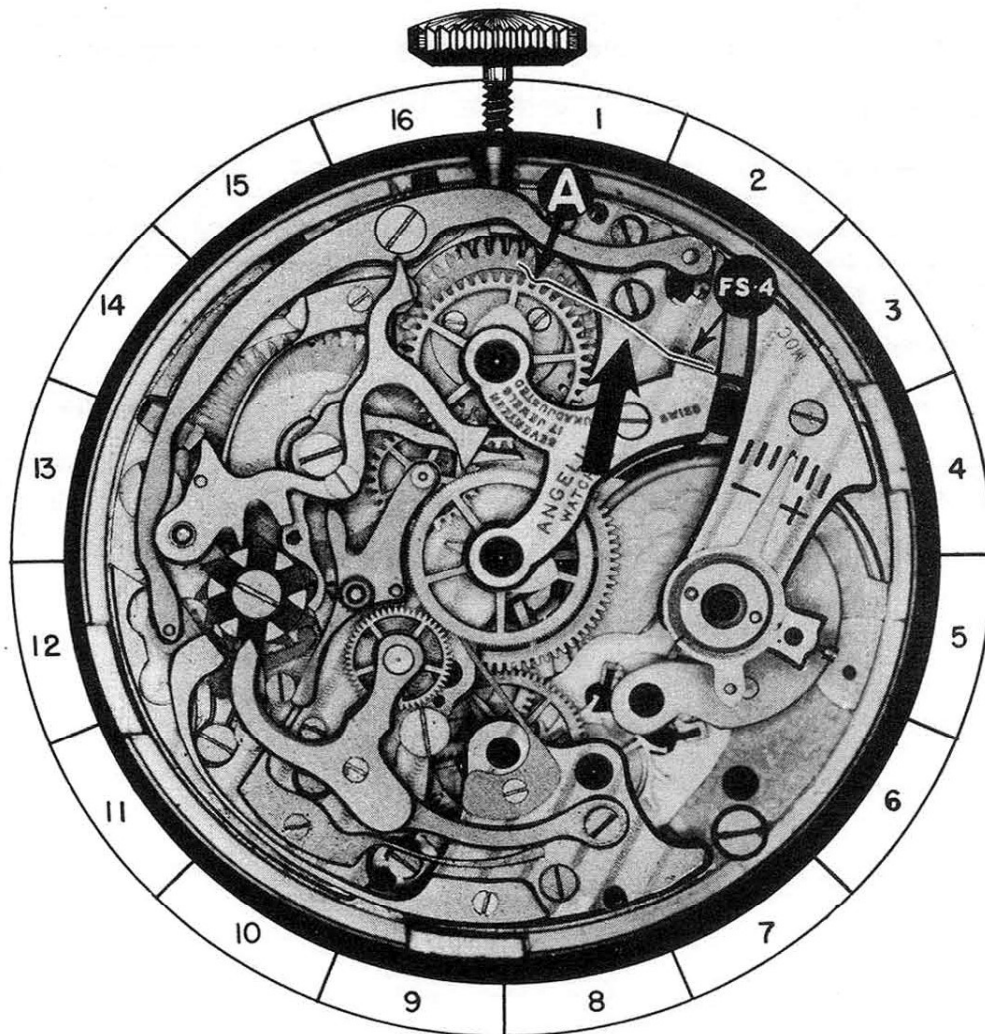

20-A

A. DISASSEMBLY PROCEDURE OF CHRONOGRAPH PIVOTED DETENT BRIDGE:

This bridge is held in place by beveled countersink screw BS-1 and steady pins. Remove screw, and loosen bridge from detent with a thin-blade screwdriver. When steady pins are free in detent, bridge may be lifted from movement.

(The shape of screw for this part is shown at bottom of page.)

B. HAZARDS IN DISASSEMBLY OF THE CHRONOGRAPH PIVOTED DETENT BRIDGE:

Keep the bridge level when removing from the detent, as any twisting of bridge may damage pivots on intermediary wheel, or burr the bushing in chronograph pivoted detent or bridge.

C. ASSEMBLY PROCEDURE OF CHRONOGRAPH PIVOTED DETENT BRIDGE:

Place the bridge on the detent, with the steady pins over the proper holes in the detent. Place the intermediary wheel so that the top pivot will enter the pivot hole in the bridge. The bridge may now be pressed down to proper position with the back of tweezers, and beveled countersink screw BS-1 replaced.

D. HAZARDS IN ASSEMBLY OF CHRONOGRAPH PIVOTED DETENT BRIDGE:

Keep the bridge level when pressing down to position, as any twisting may damage the pivots on the intermediary wheel. Check to see that there are no burrs on the surface of either the pivoted detent or the bridge where these two parts fit together. Any burrs at this location may cause the bridge to tilt either up or down, giving too little or too much endshake.

E. FUNCTION OF CHRONOGRAPH PIVOTED DETENT BRIDGE:

1. It provides a bearing surface for the upper pivot of the intermediary wheel.
2. The beak "A" of the bridge contacts the castle wheel, thus enabling the castle wheel to control the movement of the chronograph pivoted detent.

REFERENCE: Chronograph pivoted detent is Assembly 23.
Intermediary wheel is Assembly 22.
Castle wheel is Assembly 39.

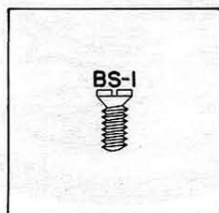

Chronograph Pivoted
Detent Bridge
Assembly No. 21

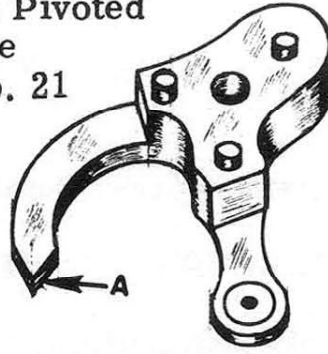

OILING

The pivot in pivot hole in chronograph pivoted detent bridge should be oiled as you would properly oil a train pivot in a watch.

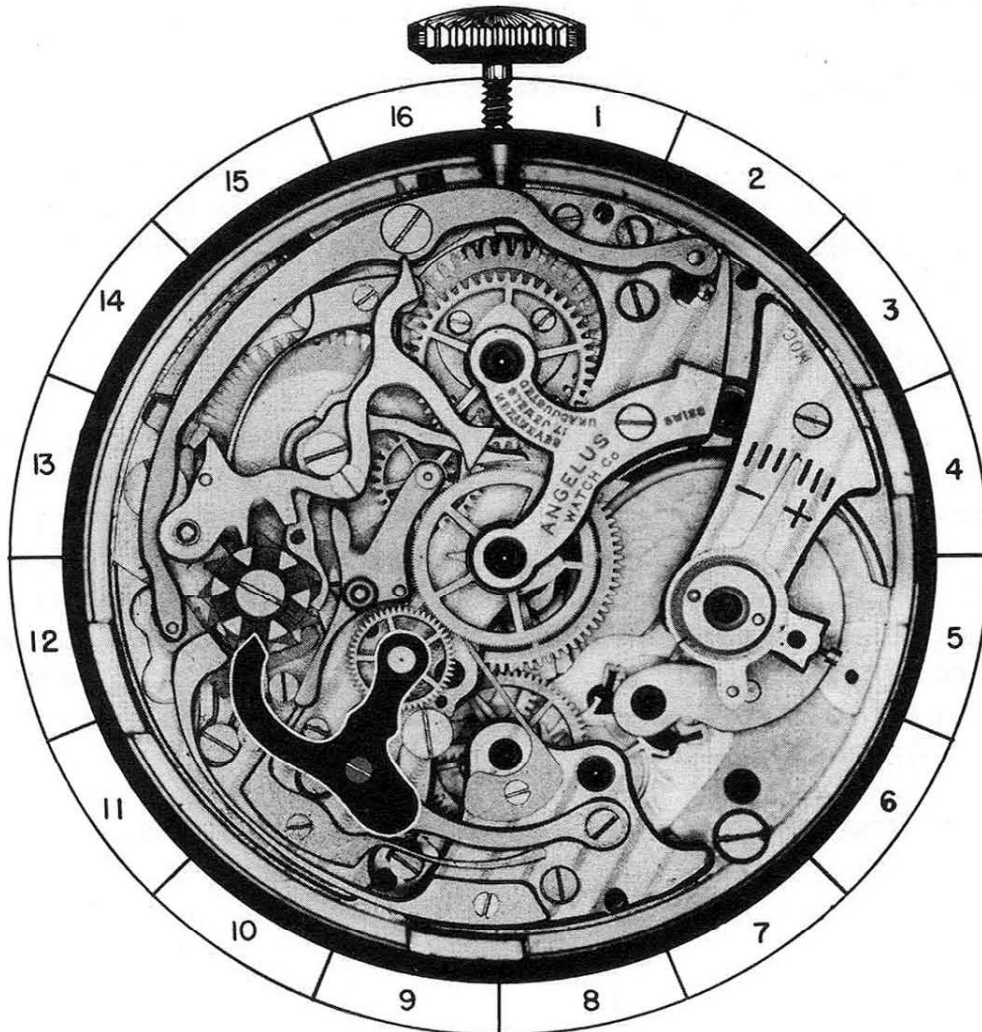

21-A

A. DISASSEMBLY PROCEDURE OF THE INTERMEDIARY WHEEL:

To remove the intermediary wheel, simply lift it out of place.

B. ASSEMBLY PROCEDURE OF THE INTERMEDIARY WHEEL:

When replacing the intermediary wheel, the end "A" of staff with the small hub "B" should be up. Place the bottom pivot of staff in hole in bushing of chronograph pivoted detent.

C. HAZARDS IN ASSEMBLY OF THE INTERMEDIARY WHEEL:

The pivot hole in bushing of chronograph pivoted detent should be carefully examined before replacing the intermediary wheel. Any imperfections here will affect the timekeeping of the watch and hinder proper operation of the chronograph.

D. FUNCTION OF THE INTERMEDIARY WHEEL:

Function of the intermediary wheel is to transmit the power from the wheel over fourth wheel to the seconds wheel when these wheels are engaged. The intermediary wheel continues to turn as long as the watch is running.

REMARKS:

A careful and detailed examination should be made of all wheels before replacing them in the chronograph. Each wheel should be examined for burred pivots, bent or burred teeth, dirt or small pieces of grit wedged between the teeth. When the VEE shaped teeth of one wheel mesh into the VEE shaped teeth of another wheel, there is very little clearance between the teeth, and because of this, the smallest piece of grit or dirt wedged between two teeth may stop the chronograph. The intermediary wheel has VEE shaped teeth.

REFERENCE: Chronograph pivoted detent is Assembly 23.
Seconds wheel is Assembly 34.
Wheel over fourth wheel is Assembly 19.

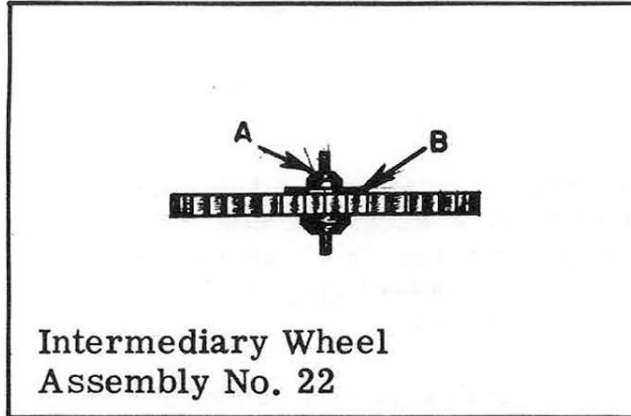

OILING

The bottom pivot of intermediary wheel should be oiled before placing in the chronograph pivoted detent. The top pivot should be oiled after the bridge for this wheel is replaced.

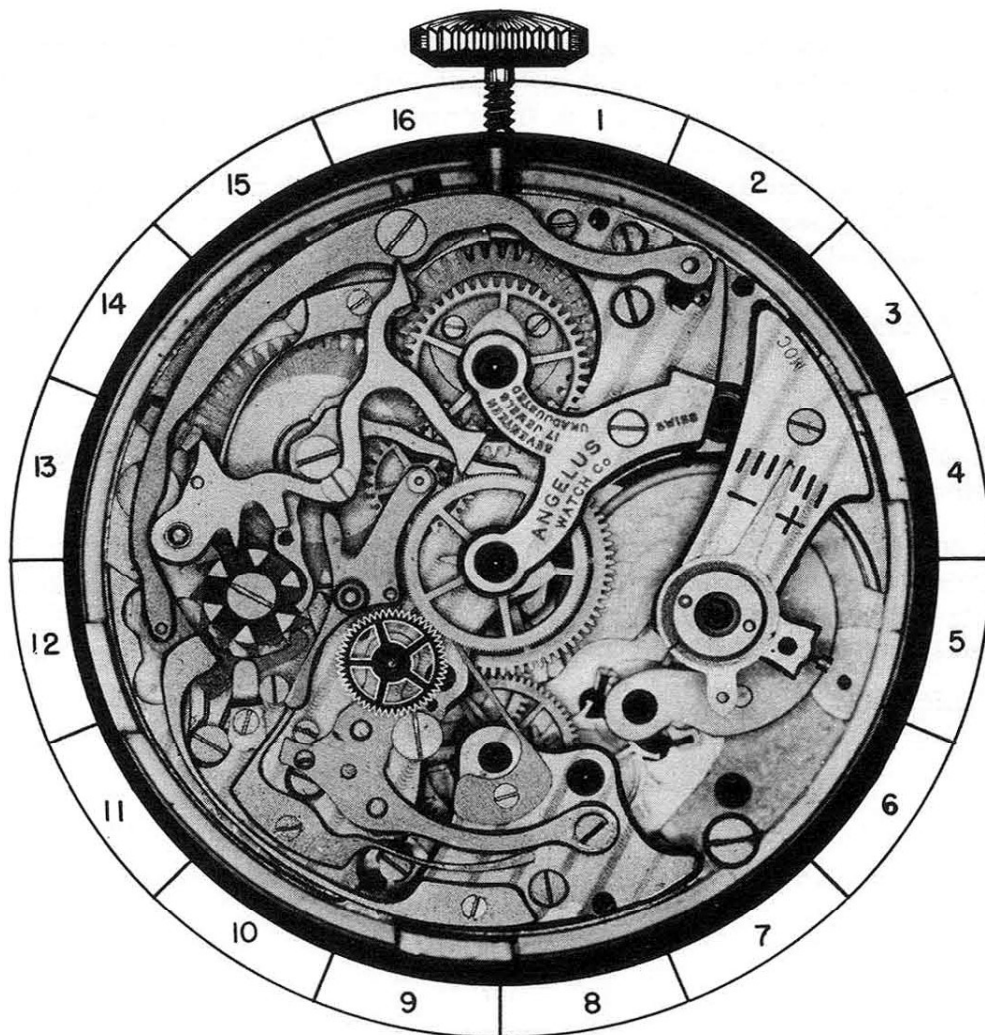

22-A

A. DISASSEMBLY PROCEDURE OF CHRONOGRAPH PIVOTED DETENT:

The chronograph pivoted detent is held in position by shouldered screw SS-11, and pivots on eccentric stud ES-1. Remove the screw SS-11, but do not turn the stud ES-1, shown in the photograph. When screw has been removed, detent may be lifted straight up on eccentric stud and free of movement.

(The shape of screw for this part is shown at bottom of page.)

B. HAZARDS IN DISASSEMBLY OF CHRONOGRAPH PIVOTED DETENT:

Lift the detent straight up when removing as any twisting may bend lever or cause burrs around hole for eccentric stud.

C. ASSEMBLY PROCEDURE OF CHRONOGRAPH PIVOTED DETENT:

Place the detent on the plate in the position shown in the photograph, with the hole in detent over eccentric stud ES-1, then press the lever down until it rests on the chronograph pivoted detent spring and move the end "B" of spring toward the outside of the watch slightly, until the lever will fit down flush on the plate; now replace shouldered screw SS-11. The detent should pivot freely under head of this screw.

D. FUNCTIONS OF CHRONOGRAPH PIVOTED DETENT:

The functions of the chronograph pivoted detent are:

1. It provides a bearing surface for the lower pivot of the intermediary wheel.
2. The chronograph pivoted detent with the chronograph pivoted detent bridge (chronograph pivoted detent bridge will be assembled later), controls the engaging and disengaging of the intermediary wheel with the seconds wheel.

REFERENCE: Intermediary wheel is Assembly 22.
Seconds wheel is Assembly 34.

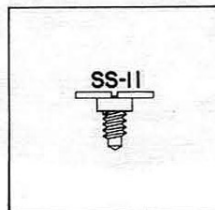

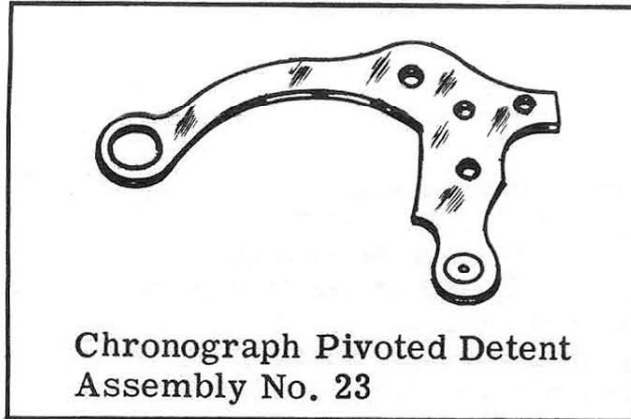

Chronograph Pivoted Detent
Assembly No. 23

OILING

1. The eccentric stud on which the chronograph pivoted detent pivots should be slightly moistened with oil at point of contact with the chronograph pivoted detent.
2. The end "B" of the chronograph pivoted detent spring at point of contact with the chronograph pivoted detent should be slightly moistened with oil.

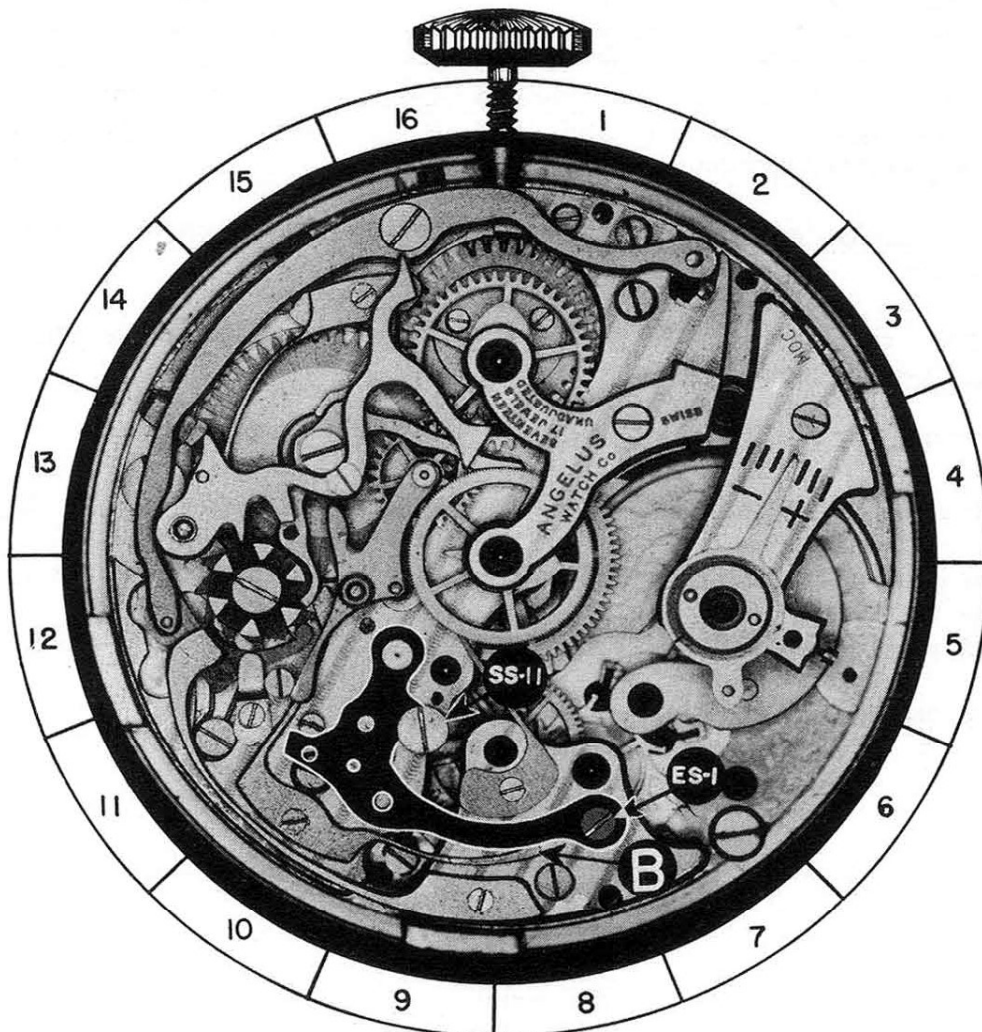

23-A

A. DISASSEMBLY PROCEDURE OF ACTUATING DETENT LEVER SPRING:

The actuating detent lever spring is held in place by fillister head screw FS-5, and steady pins. Lift the end "A" of spring up slightly until the pin "B", shown in the isometric drawing, rests on top of the joint hook; this will release the tension on the spring. Now remove the screw and loosen the spring from the plate by sliding a finely ground screwdriver between the plate and the base of the spring. When the steady pins are free in the plate, the spring may be lifted from the movement.

(The shape of screw for this part is shown at bottom of page.)

B. ASSEMBLY PROCEDURE OF ACTUATING DETENT LEVER SPRING:

Place the spring in position on the plate, with the steady pins over the proper holes in the plate. Now press the spring down until the base of the spring is flush on the plate, and replace fillister head screw FS-5. Move the end "A" of spring towards the outside of the watch until the pin "B" is in a position to force the joint hook towards the center of the watch, and the part "C" of the spring is resting on the joint hook.

C. HAZARDS IN ASSEMBLY OF THE ACTUATING DETENT LEVER SPRING:

Be sure that the joint hook is in the position shown in the photograph before replacing the spring.

D. FUNCTIONS OF THE ACTUATING DETENT LEVER SPRING:

1. It keeps the joint hook engaged with the ratchet teeth on the castle wheel.
2. It holds a tension on the joint hook, forcing it towards the center of the watch.
3. It helps to hold the joint hook down in place.

REFERENCE: Joint hook is Assembly 26.
Castle wheel is Assembly 39.

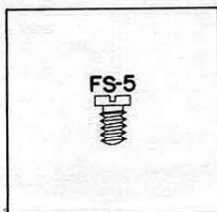

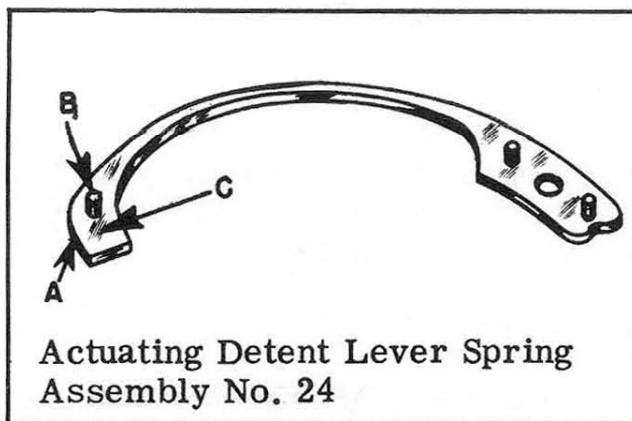

OILING

The flat surface "B" of spring at point of contact with joint hook should be slightly moistened with oil.

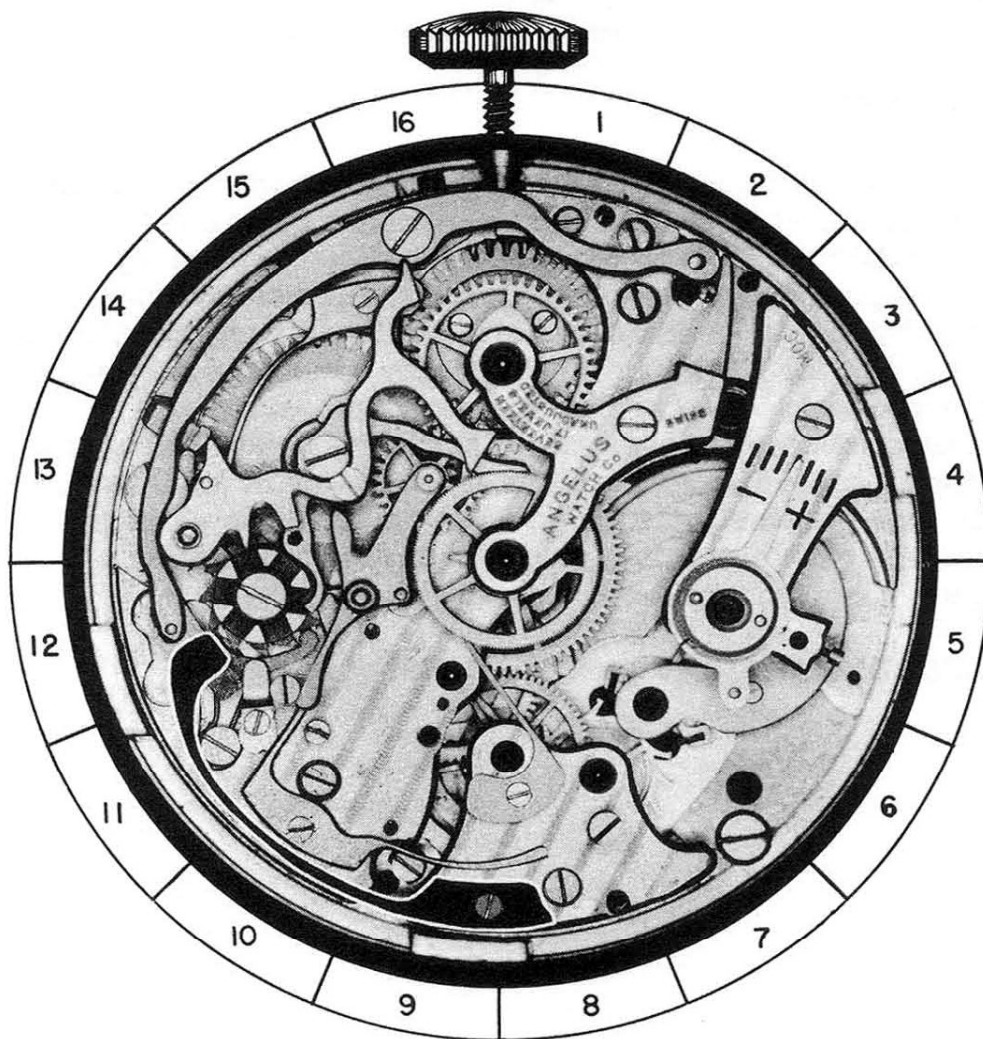

24-A

A. DISASSEMBLY PROCEDURE OF JOINT HOOK PLATE:

The joint hook plate is held in position by beveled countersink screw BS-2. Remove screw, and plate will be free on movement and may be lifted out of place.

(The shape of screw for this part is shown at bottom of page.)

B. ASSEMBLY PROCEDURE OF JOINT HOOK PLATE:

Place the plate on the movement in the position shown in the photograph. Now replace beveled countersink screw BS-2 to hold the plate in position.

C. FUNCTION OF THE JOINT HOOK PLATE:

The function of the joint hook plate is to prevent the joint hook from working up and coming out of position.

REMARKS:

When disassembling the chronograph, each part should be carefully examined as it is removed from the movement. Each part should be checked against the isometric drawing to see that the part has the correct shape and is not broken. Each part should also be checked for any pits of rust, roughness, or burrs, and for worn parts, which may cause the part not to work properly. The replacement of a defective part in the chronograph may necessitate a complete disassembly of the chronograph. Through a close examination of each part, you will soon become familiar with the parts of the chronograph. This will enable you to quickly recognize a defective part and repair it before replacing it in the chronograph.

REFERENCE: Joint hook is Assembly 26.

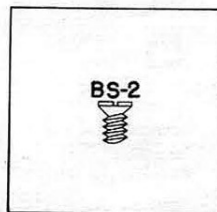

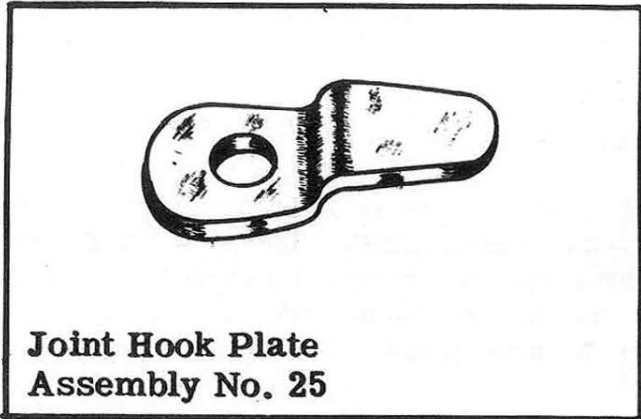

OILING

The joint hook plate should not be oiled.

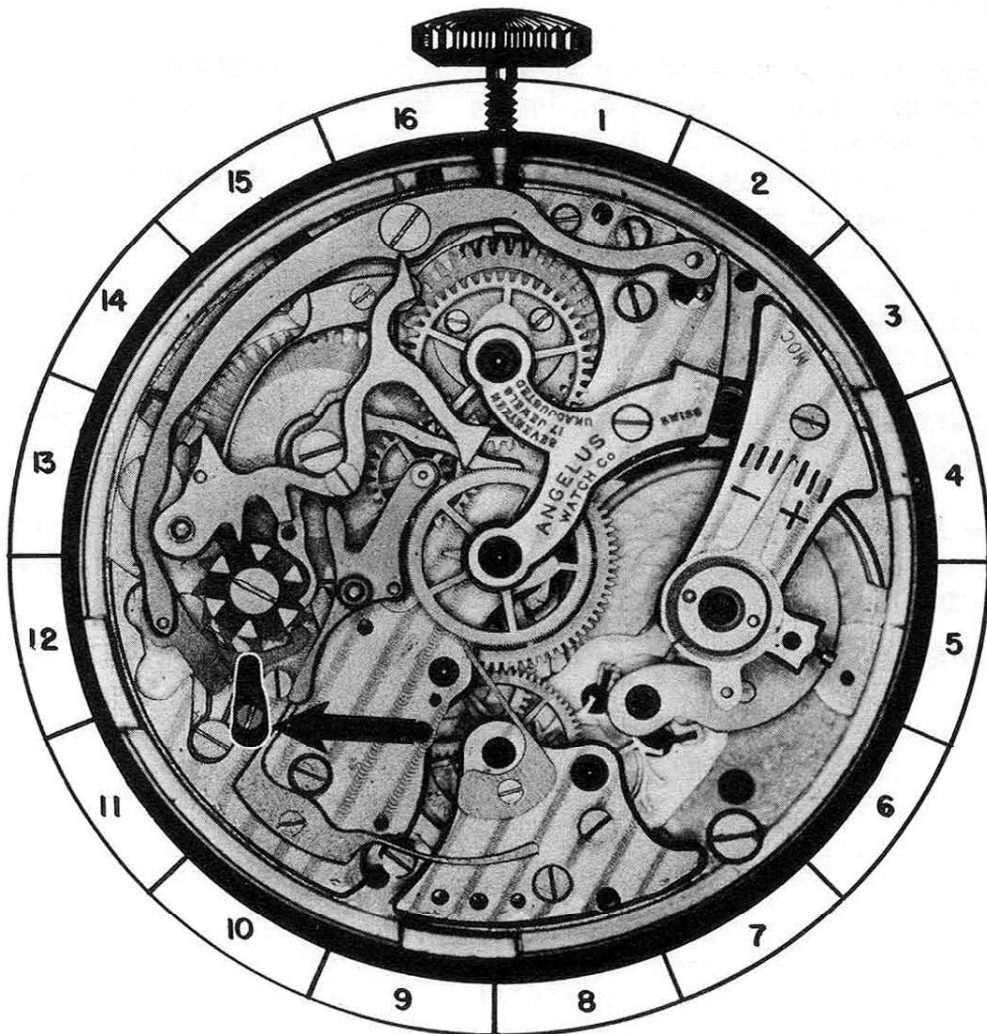

25-A

A. DISASSEMBLY PROCEDURE OF THE ACTUATING DETENT LEVER AND JOINT HOOK:

The actuating detent lever is held in place by shouldered screw SS-12, and pivots on this screw. Remove the screw, and unhook the joint hook, shown as "A" in the isometric drawing, from the ratchet teeth on the castle wheel. The actuating detent lever may now be lifted from the movement.

NOTE:

The joint hook is held to the actuating lever by a shouldered screw SS-13, and pivots on this screw. To remove the joint hook, remove the screw and joint hook will be free of actuating detent lever.

(The shape of screws for this part is shown at the bottom of page.)

B. ASSEMBLY PROCEDURE OF ACTUATING DETENT LEVER AND JOINT HOOK:

Place the joint hook on the underside of the actuating detent lever in the position shown in the isometric drawing, and replace shouldered screw SS-13, to hold joint hook in position. The joint hook should pivot freely on actuating detent lever. Now place the actuating detent lever and joint hook on the movement in the position shown in the photograph, with the end "A" of joint hook engaged with the ratchet teeth on the castle wheel. Replace the shouldered screw SS-12 to hold lever in position, and check to see that lever pivots freely under the head of screw.

C. FUNCTION OF THE ACTUATING DETENT LEVER AND JOINT HOOK:

The function of the actuating detent lever and joint hook is to turn the castle wheel one ratchet tooth, each time the end "B" of actuating detent lever is pushed.

REFERENCE: Castle wheel is Assembly 39.

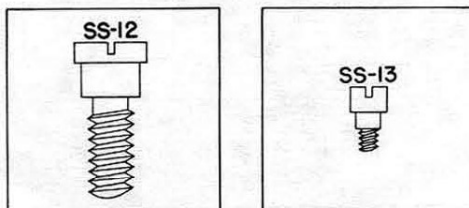

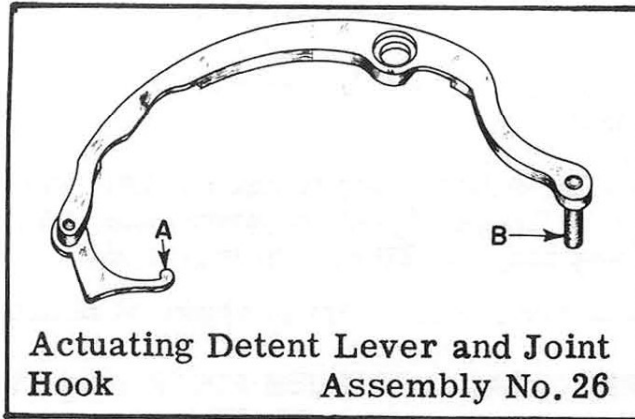

OILING

The shoulder of screw on which the actuating detent lever pivots and the shoulder of screw which holds the joint hook to actuating detent lever should be slightly moistened with oil.

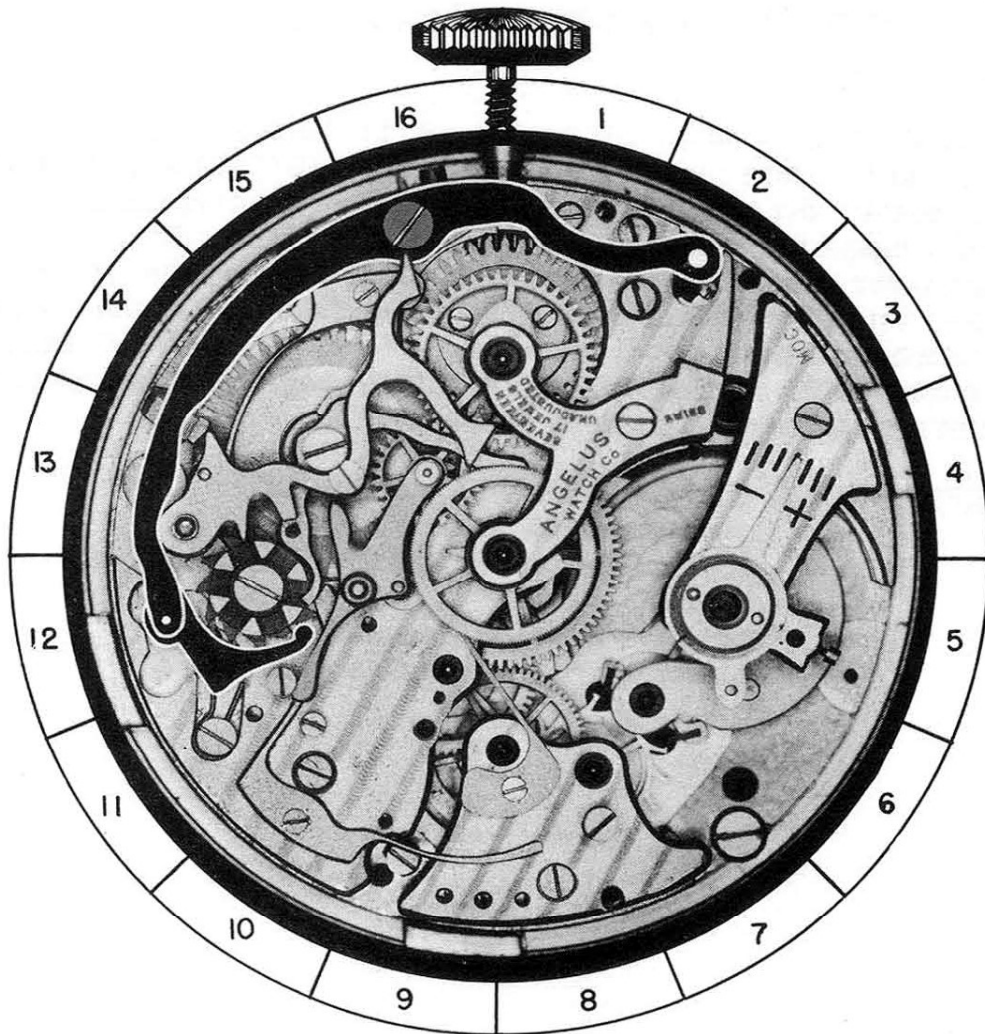

A. DISASSEMBLY PROCEDURE OF PUSH PIECE FOR SETTING BACK TO ZERO:

The push piece for setting back to zero is held in position by shouldered screw SS-14. Remove screw, and push piece will be free on plate and may be lifted from movement.

(The shape of screw for this part is shown at bottom of page.)

B. ASSEMBLY PROCEDURE OF PUSH PIECE FOR SETTING BACK TO ZERO:

Place the push piece in its proper position on the plate, as shown in the photograph. Now replace shouldered screw SS-14, to hold push piece in position.

C. FUNCTION OF THE PUSH PIECE FOR SETTING BACK TO ZERO:

Function of the push piece when pushed, is to move the flyback lever toward the hearts to return them to a zero position.

REMARKS:

When the flyback lever is forced towards the hearts on the seconds wheel and minute register wheel, the part "D" of the flyback lever will contact the pin "C" on the brake lever, forcing the brake lever to disengage from the seconds wheel. The screw "E" on the flyback lever contacts the intermittent lever to move the intermittent wheel out of the path of the dart tooth, and then, after the above two functions are performed, the ends "A" and "B" of the flyback lever contact the seconds wheel and minute register wheel hearts to return these hearts to a zero position.

REFERENCE: Flyback lever is Assembly 28
 Brake lever is Assembly 29.
 Intermittent lever and wheel assembly is Assembly 36.
 Seconds wheel is Assembly 34.
 Minute register wheel is Assembly 33.

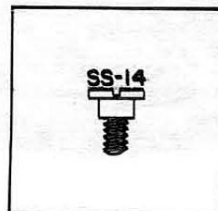

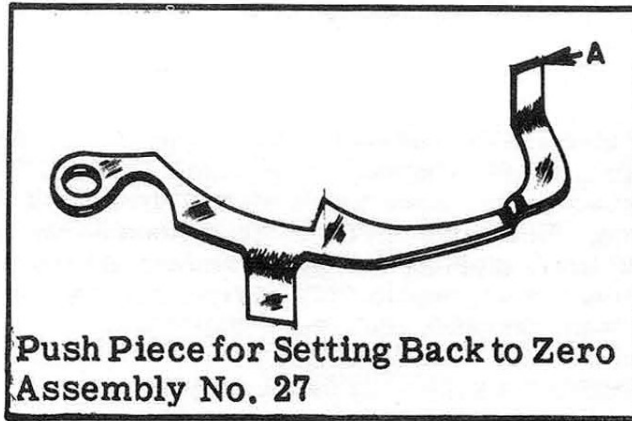

Push Piece for Setting Back to Zero
Assembly No. 27

OILING

The shoulder of the screw on which the push piece pivots should be slightly moistened with oil.

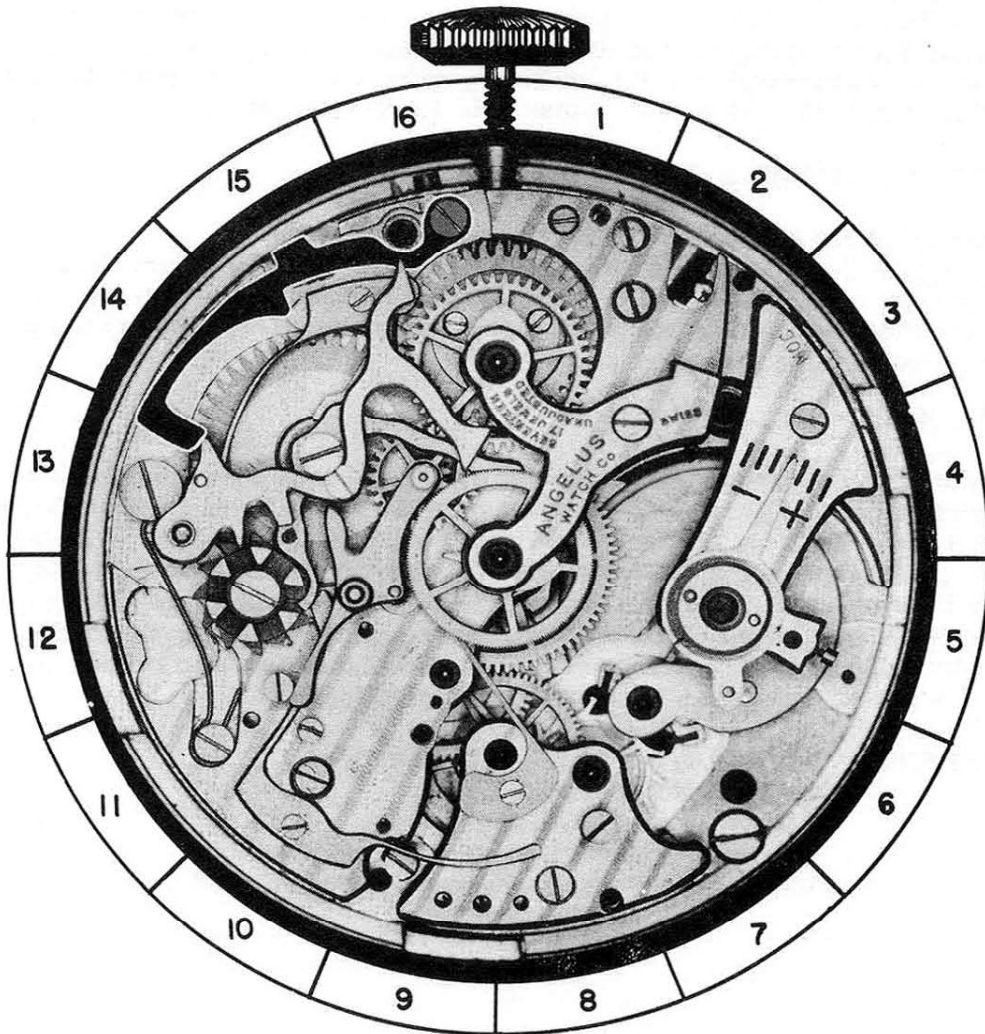

27-A

A. DISASSEMBLY PROCEDURE OF FLYBACK LEVER:

The flyback lever pivots on a post on the plate, and is held in position by the flyback lever spring, which is hooked to the screw head "C" on flyback lever. To remove the flyback lever, place a thin blade screwdriver at end "A" of flyback lever spring. Now force spring slightly towards the center of the watch; at the same time, applying a slight downward pressure. This will unhook the spring from the screwhead "C" on flyback lever, and the flyback lever may be lifted from the post, and free of movement.

B. HAZARDS IN DISASSEMBLY OF FLYBACK LEVER:

Before removing flyback lever, unhook the flyback lever spring from the screwhead "C" on flyback lever. This must be done so that flyback lever spring is not broken when lifting flyback lever from the movement.

C. ASSEMBLY PROCEDURE OF FLYBACK LEVER:

Place the flyback lever in the position shown in the photograph, with the screwhead "C" down. Press lever down until screwhead "C" rests on top of flyback lever spring. Hold flyback lever down with finger and force the end "A" of flyback lever spring slightly towards the center of watch, at the same time, raising it slightly. This will hook the end "A" of spring between the screwhead and flyback lever, which will hold the lever down in position and at the same time, cause it to function properly.

D. FUNCTIONS OF THE FLYBACK LEVER ARE:

1. Disengage the brake lever from the seconds wheel.
2. Disengage the intermittent wheel from the seconds wheel dart tooth.
3. The ends "A" and "B" of flyback lever contact the hearts on the seconds wheel and minute register wheel, forcing these wheels and hands attached to them, to a zero position.

REMARKS:

When the flyback lever is moved to return the seconds wheel and minute register wheel to a zero position, the part "D" of the flyback lever should contact the pin "C" of the brake lever. (The position of this pin is shown in the photograph of the brake lever.) This pin should resist the moving of the flyback lever. When sufficient pressure is applied to the flyback lever to force the pin out of the way, the lever should move very suddenly, and with sufficient force to assure that the seconds wheel and minute register wheel are returned to an exact zero position.

REFERENCE: Flyback lever spring is Assembly 30.
Brake lever is Assembly 29.
Seconds wheel is Assembly 34.
Minute register wheel is Assembly 33.
Intermittent lever and wheel is Assembly 36.

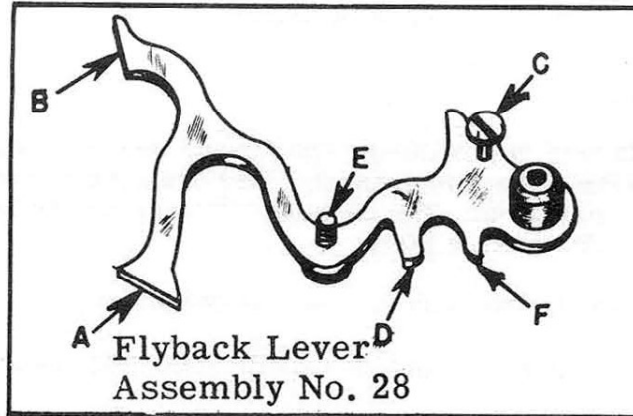

OILING

Slightly moisten the flyback lever with oil at these points:

1. The post on which the flyback lever pivots.
2. The screwhead "C" at point of contact with flyback lever spring.
3. Screw "E" at point of contact with intermittent lever.
4. Surface "D" at point of contact with pin on brake lever.

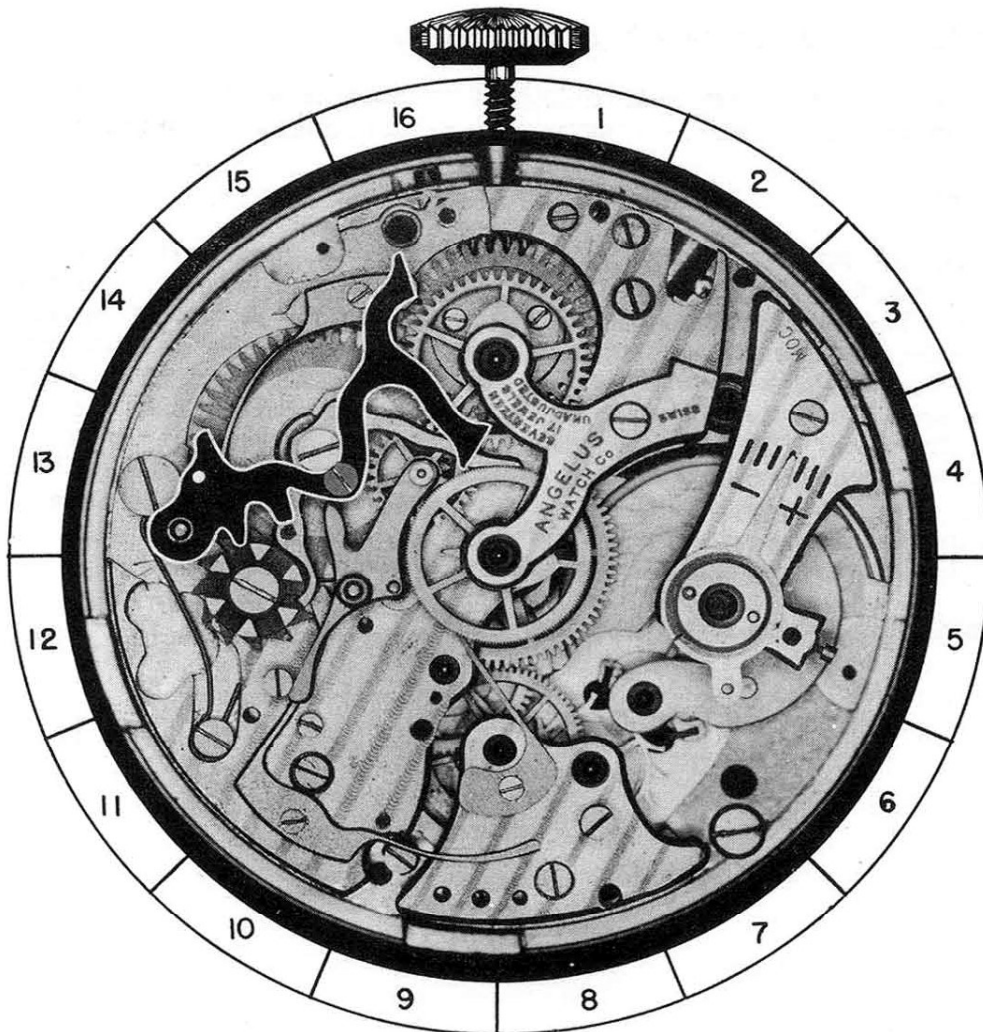

A. DISASSEMBLY PROCEDURE OF BRAKE LEVER AND BUSHING:

The brake lever is held in position by shouldered screw SS-15, and the bushing "B" shown in the isometric drawing. Remove screw, and brake lever can be lifted from movement. The bushing "B" will now be free on barrel arbor, and may be lifted out of place.

(The shape of screw for this part is shown at bottom of page.)

B. ASSEMBLY PROCEDURE OF BRAKE LEVER AND BUSHING:

Turn the castle wheel to the position shown in the photograph, so that when replacing the brake lever, the end "D" of this lever will be between two columns of the castle wheel. Now place the brake lever over the bushing, in the position shown in the photograph. The pin "E" on the brake lever spring should be on the side of the brake lever spring, so that the brake lever spring will force the brake lever in the direction to engage with the seconds wheel. With the brake lever in this position, replace shouldered screw SS-15 to hold the lever in place. The brake lever should pivot freely under the head of this screw.

C. FUNCTION OF BRAKE LEVER AND BUSHING:

The function of the brake lever is to hold the seconds wheel stationary, when the seconds wheel is disengaged from the chronograph mechanism.

REMARKS:

When the chronograph is engaged, the brake lever is disengaged from the seconds wheel by the castle wheel; this permits the seconds wheel to turn freely. When the chronograph is disengaged, the end "D" of the brake lever enters between two columns of the castle wheel, which permits the end "A" of the brake lever to engage with the seconds wheel. This holds the seconds wheel stationary, so that a bump or jar cannot alter the position of the wheel. When the flyback lever is moved to the center of the watch to return the wheels to zero, the flyback lever contacts the pin "C", shown in the photograph, and disengages the end "A" of the brake lever from the seconds wheel. This permits the seconds wheel to be turned by the flyback lever, without interference of the brake lever.

REFERENCE: Castle wheel is Assembly 39.
 Seconds wheel is Assembly 34.
 Brake lever spring is Assembly 31.
 Flyback lever is Assembly 28.

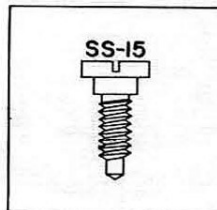

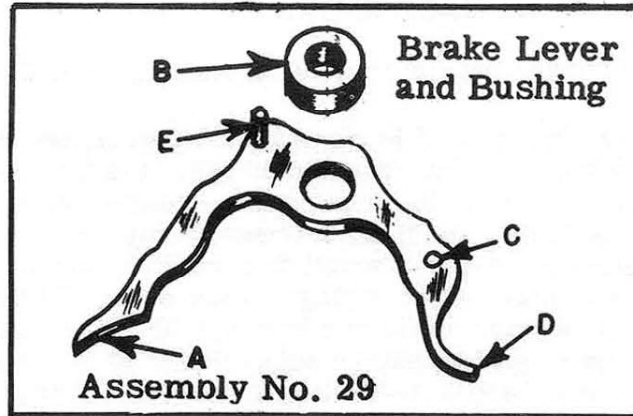

OILING

The shoulder of screw on which the brake lever pivots should be slightly moistened with oil. The pin "E" in brake lever should be slightly moistened with oil at point of contact with the brake lever spring.

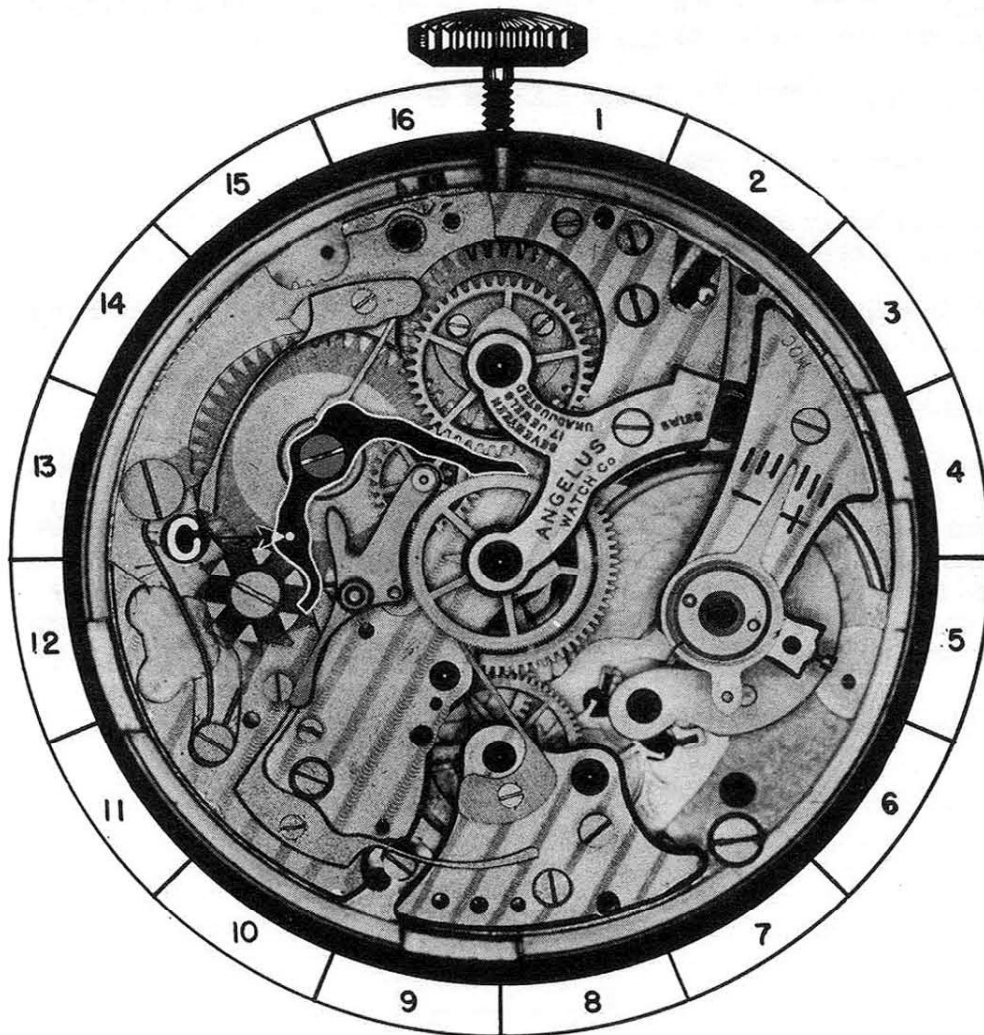

29-A

A. DISASSEMBLY PROCEDURE OF FLYBACK LEVER SPRING:

The flyback lever spring is held in place by beveled countersink screw BS-3, and steady pins. This screw and pins also hold the brake lever spring in position, and both of these parts are removed as a unit. Remove the screw, and loosen the flyback lever spring and brake lever spring from the plate by sliding a small thin-bladed screwdriver between the base of the brake lever spring and the plate. When the steady pins are free in the plate, these springs may be lifted from the movement. The brake lever spring may be separated from the flyback lever spring by sliding a thin-bladed screwdriver between the springs.

(The shape of screw for this part is shown at bottom of page.)

B. ASSEMBLY PROCEDURE OF FLYBACK LEVER SPRING:

Place the flyback lever spring in the position shown in the photograph, with the steady pins entering the holes in the brake lever spring. Now press the flyback lever spring down until the steady pins pass through the brake lever spring into the proper holes in the plate. With the springs in proper position, the beveled countersink screw BS-3 may be replaced to hold these springs in place.

C. FUNCTIONS OF THE FLYBACK LEVER SPRING:

The functions of the flyback lever spring are:

1. To hold the flyback lever away from the center of the watch, and return it to this position after it has been pushed and released.
2. To hold the flyback lever down on the post, preventing it from riding up and coming out of position.

REMARKS:

The flyback lever spring should hold the flyback lever away from the center of the watch and down on the post. Any tension on this spring, beyond what is necessary to cause the flyback lever to function in this manner, should be avoided. The spring holding too much tension towards the outside of the watch makes the flyback lever unnecessarily hard to push, or it may cause the spring to break. Too strong a downward tension may cause the flyback lever to bind on the post.

REFERENCE: Flyback lever is Assembly 28.
Brake lever spring is Assembly 31.

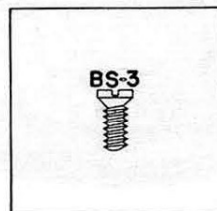

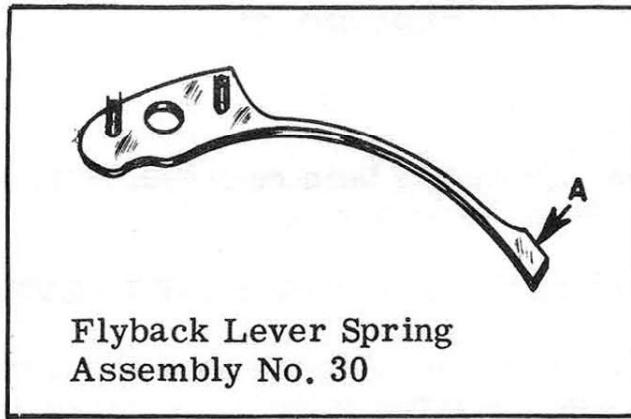

OILING

The flyback lever spring should not be oiled.

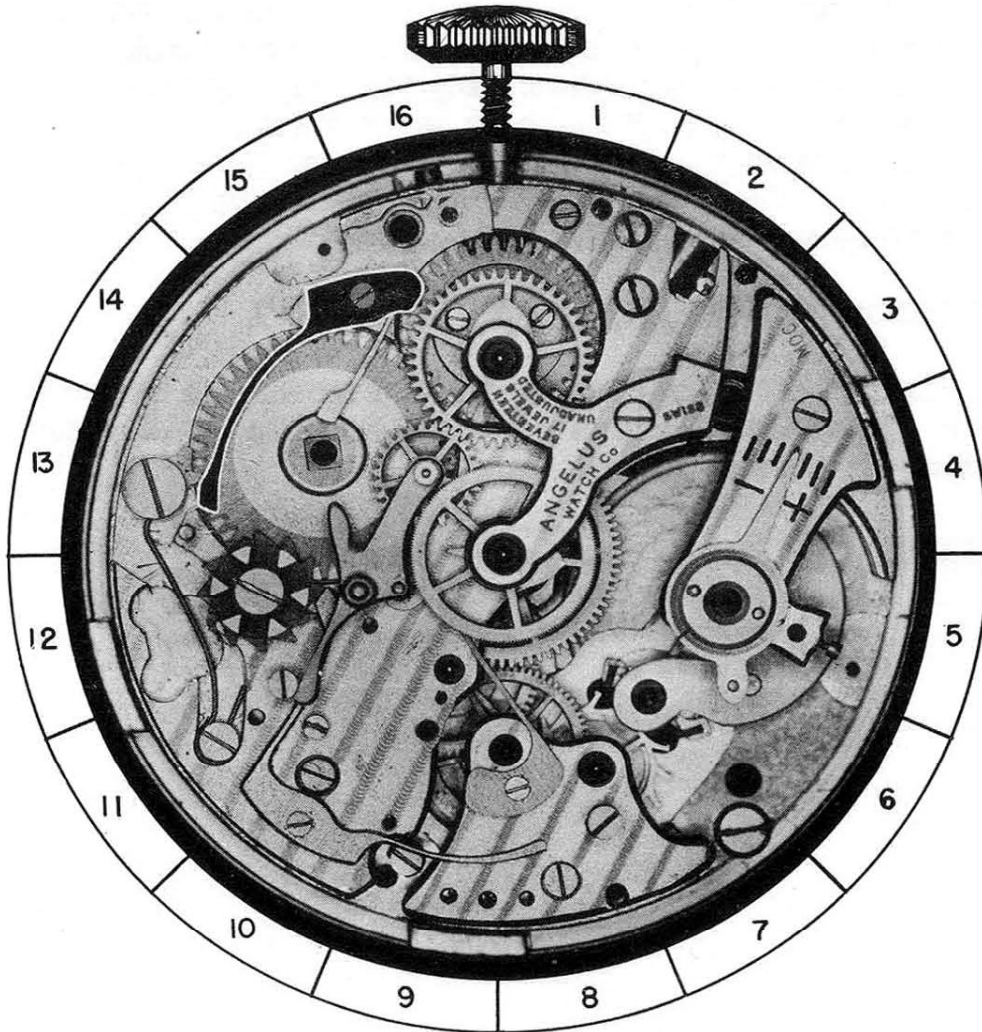

30-A

A. DISASSEMBLY PROCEDURE OF BRAKE LEVER SPRING:

The brake lever spring has been removed, as it was disassembled with the flyback lever spring.

B. ASSEMBLY PROCEDURE OF THE BRAKE LEVER SPRING:

Place the brake lever spring on the plate in the position shown in the photograph. The two holes in the spring should be over the proper holes in the plate. The brake lever spring will be held in place by the flyback lever spring, which is the next part to be replaced.

NOTE: -- IMPORTANT

The brake lever spring and the flyback lever spring (the flyback lever spring is the next part to be replaced), may be assembled and replaced as a unit. Place the flyback lever spring on the bench with the steady pins up, and place the brake lever spring on the flyback lever spring in the correct position. Now replace the flyback lever spring and brake lever spring in position shown in photograph on page 30-A, and replace screw to hold the springs in place.

C. FUNCTION OF THE BRAKE LEVER SPRING:

The function of this spring is to hold a tension on the brake lever. This tension forces the brake lever in the direction to contact the seconds wheel.

REFERENCE: Brake lever is Assembly 29.
Seconds wheel is Assembly 34.
Flyback lever spring is Assembly 30.

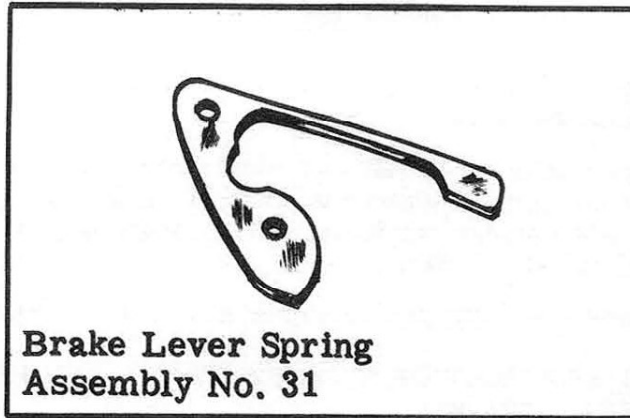

**Brake Lever Spring
Assembly No. 31**

OILING

The brake lever spring should not be oiled.

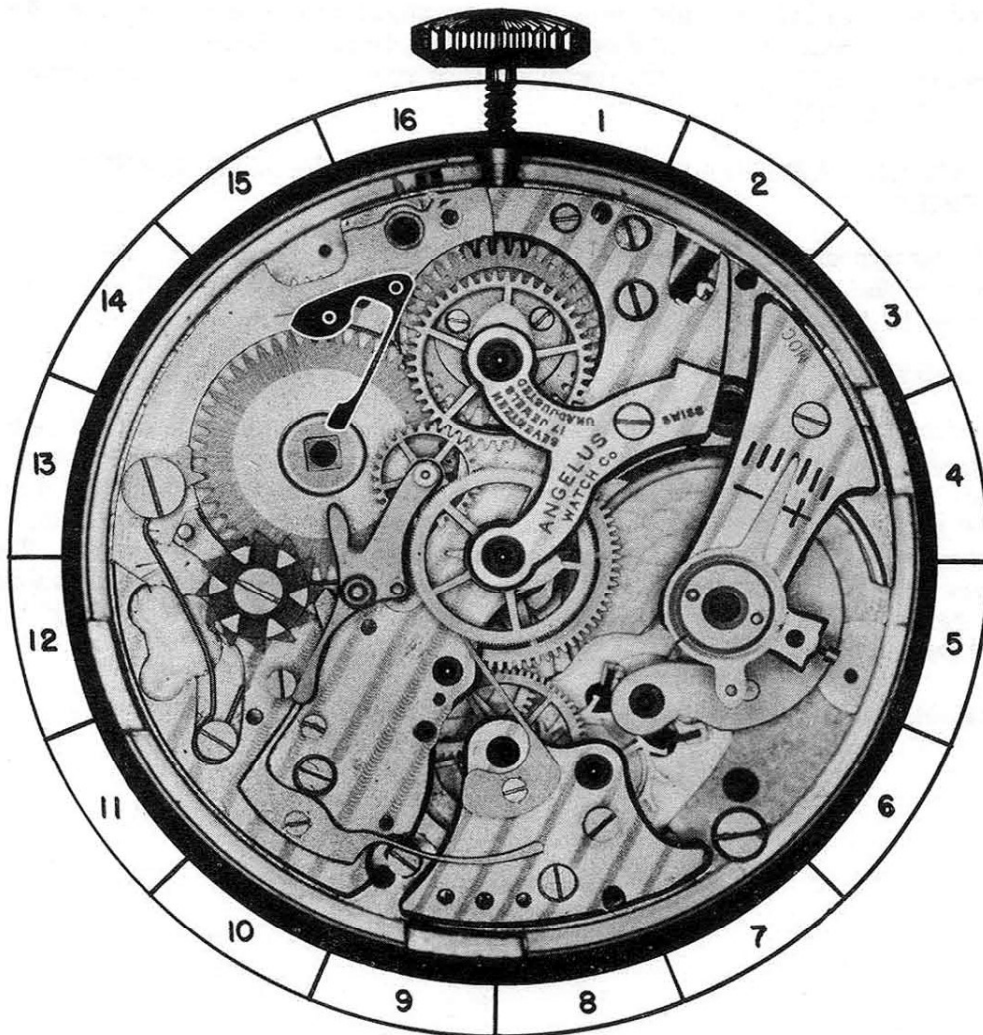

31-A

A. DISASSEMBLY PROCEDURE OF SECONDS WHEEL AND MINUTE REGISTER WHEEL BRIDGE:

This bridge is held in place by fillister head screw FS-6, and steady pins. Remove screw and loosen bridge from plate by sliding a thin-bladed screwdriver between bridge and plate. When steady pins are free in plate, bridge may be lifted out of place.

(The shape of screw for this part is shown at bottom of page.)

B. HAZARDS IN DISASSEMBLY OF SECONDS WHEEL AND MINUTE REGISTER WHEEL BRIDGE:

When removing bridge from plate, avoid twisting of bridge, as this may damage pivots on wheels or chip the jewels in the bridge. The screwdriver should be carefully used to prevent marring of bridge or plate.

C. ASSEMBLY PROCEDURE OF SECONDS WHEEL AND MINUTE REGISTER WHEEL BRIDGE:

Place this bridge on the plate, with the steady pins over the proper holes in the plate. Place top pivots of seconds wheel and minute register wheel, so that they will enter the jewel holes in the bridge. Bridge may now be pressed down to proper place with back of tweezers, and fillister head screw FS-6 replaced.

D. FUNCTION OF SECONDS WHEEL AND MINUTE REGISTER WHEEL BRIDGE:

The function of this bridge is to provide a bearing surface for the top pivots of the seconds wheel and minute register wheel; also, it provides a base for the minute register pawl.

REMARKS:

The heart on the seconds wheel and minute register wheel must be highly polished, as any roughness or pits of rust may prevent the flyback lever from returning these wheels to a zero position. When polishing the heart, care should be taken that shape of heart is not changed. The heart on these wheels should be tested to see that they are tight on the wheel. The heart being loose on the wheels may result in one or both of these wheels not returning to a zero position, when the flyback lever is brought in contact with the hearts.

REFERENCE: Seconds wheel is Assembly 34.
Minute register wheel is Assembly 33.
Flyback lever is Assembly 28.

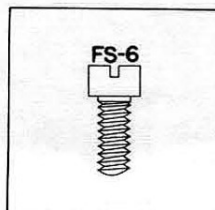

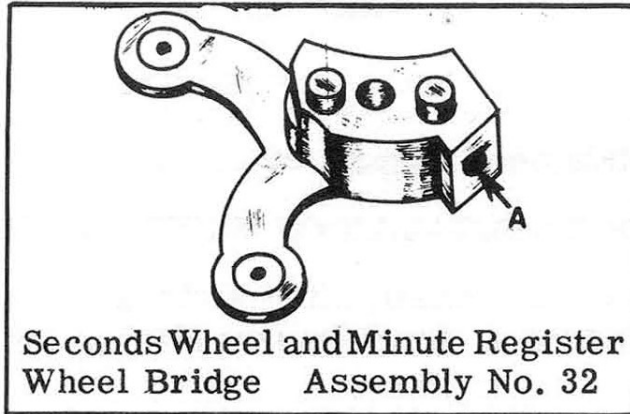

OILING

The pivots in the jewels in the bridge should be oiled as you would properly oil a train pivot in a watch.

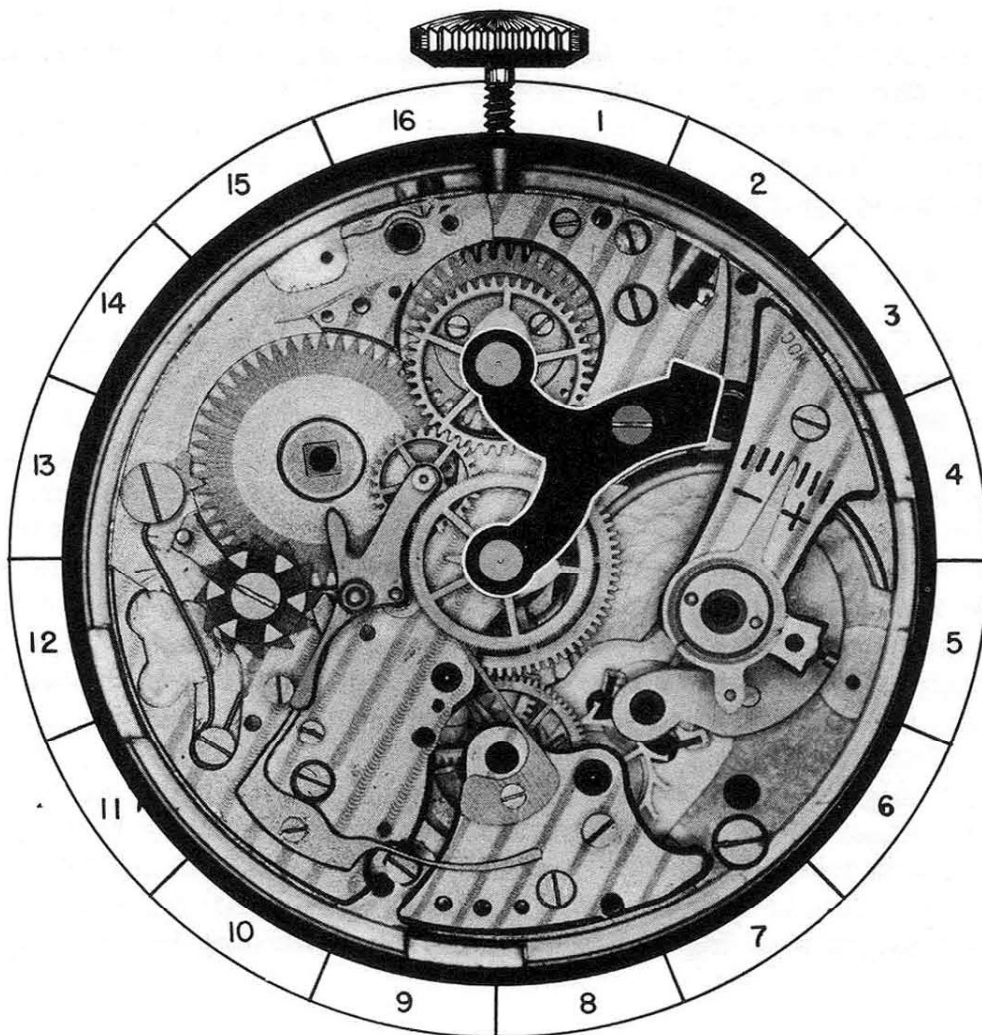

32-A

A. DISASSEMBLY PROCEDURE OF MINUTE REGISTER WHEEL:

To remove this wheel, simply lift it out of place.

B. HAZARDS IN DISASSEMBLY OF MINUTE REGISTER WHEEL:

When removing this wheel, lift straight up out of watch, as any twisting may bend or break the long pivot on the minute register wheel.

C. ASSEMBLY PROCEDURE OF MINUTE REGISTER WHEEL:

Place the minute register wheel on the plate in the position shown in the photograph. The long pivot "B" on this wheel must go down in the watch.

D. FUNCTION OF THE MINUTE REGISTER WHEEL:

The function of the minute register wheel is to record the minutes that have elapsed since the beginning of the registration of the chronograph sweep second hand. This is done by a hand which is attached to the long pivot "B" of the minute register wheel. The heart "A" on the minute register wheel is to return the wheel and hand to a zero position.

REMARKS:

With the flyback lever holding the seconds wheel and minute register wheel at a zero position, check with a very fine broach to see if either of these wheels can be turned. The minute register wheel should turn slightly, but the seconds wheel should be held very tight by the flyback lever. It is most essential for the seconds wheel to be held stationary by the flyback lever. In the case of the minute register wheel, it does not have to be held absolutely stationary by the flyback lever as the minute register pawl will serve this purpose. The only thing the minute register wheel should be checked for is to see that it will not turn far enough in one direction or the other to let the minute register pawl drop into another space between the next two teeth. The slight turning of the minute register wheel at a zero position assures that all the pressure of the flyback lever is on the seconds wheel heart. Thus, we are assured that the seconds wheel will always return to an exact zero position, even if there is a slight wearing of the parts in the returning to zero mechanism.

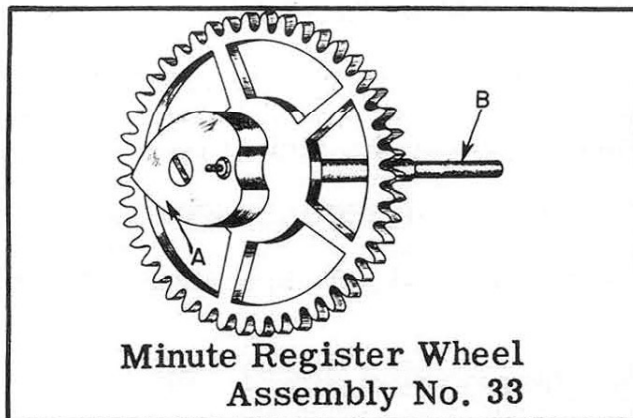

OILING

The bottom pivot of the minute register wheel should be oiled as you would normally oil a train pivot in a watch. The top pivot should be oiled after bridge for wheel is replaced.

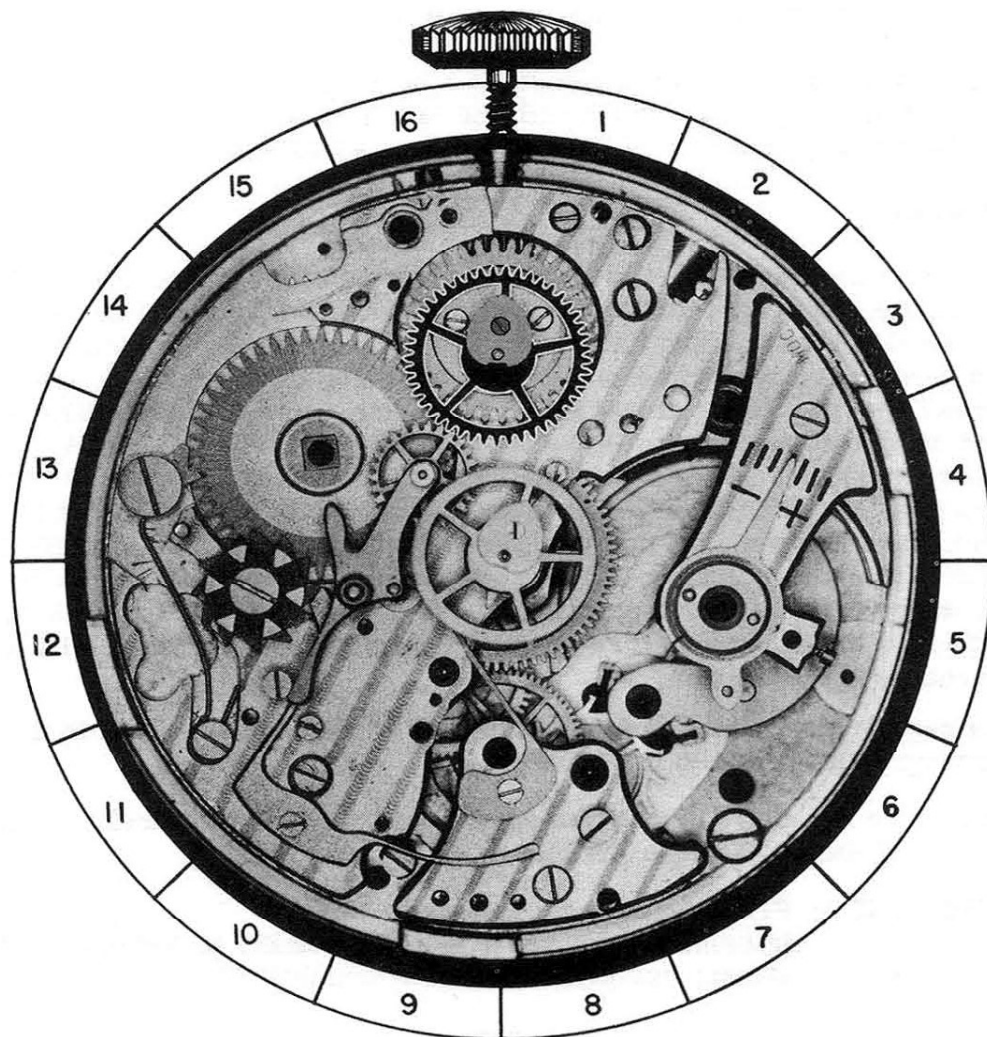

33-A

A. DISASSEMBLY PROCEDURE OF SECONDS WHEEL:

The seconds wheel is simply lifted out of place to remove it.

B. ASSEMBLY PROCEDURE OF SECONDS WHEEL:

Place the wheel in position with the long pivot "A" down in hollow center wheel pinion.

C. FUNCTIONS OF THE SECONDS WHEEL ARE:

1. It registers the seconds that have elapsed since the beginning of the registration. This is done by a hand being attached to the long pivot "A" on the seconds wheel.
2. The seconds wheel must move the minute register wheel forward one tooth each time the seconds wheel makes one revolution. This is done by the dart tooth "C" attached to the seconds wheel. The dart tooth meshes with the teeth of the intermittent wheel, which in turn moves the minute register wheel one tooth.
3. The seconds wheel must return to a zero position when the flyback lever is brought in contact with the heart on this wheel. The seconds wheel heart is shown as "B" in the isometric drawing.

REMARKS:

The seconds wheel is returned to a zero position by the flyback lever contacting the heart "B" on the seconds wheel. The heart is set eccentric on this wheel. The flat end of the flyback lever contacts the heart and forces the heart to turn until the flat end of the flyback lever sets across the two lobes at the top of the heart. With the pressure equalized on these two lobes, the heart will turn no further, and this will be a zero position. If the wheel has turned less than 160 degrees from a zero position when the flyback lever is brought in contact with the heart, it will turn the wheel in the opposite direction to which it was turning to return to a zero position. On the other hand, if the wheel is turned past 160 degrees from a zero position, the flyback lever will force the heart and wheel to continue to turn in the direction it was turning, until it reaches a zero position.

The degree used above is approximate, as this degree varies in most chronographs from 160 to 170 degrees.

(For more detailed information on the returning of the wheels to zero, refer to Volume 24 of the Esembl-O-Graf Library.)

REFERENCE: Flyback lever is Assembly 28.
Intermittent lever and wheel assembly is Assembly 36.
Minute register wheel is Assembly 33.

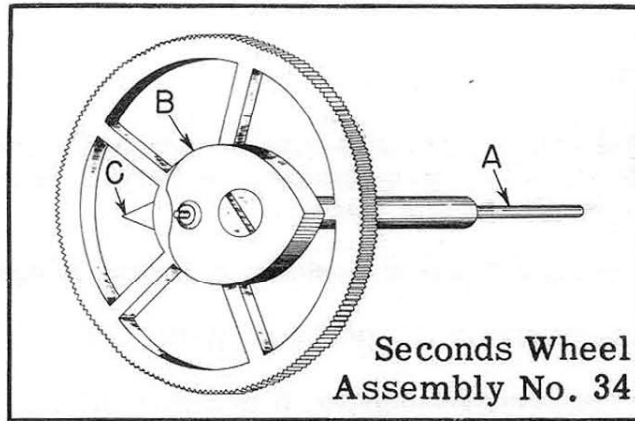

OILING

The top pivot of the seconds wheel should be oiled after bridge for this wheel is replaced.

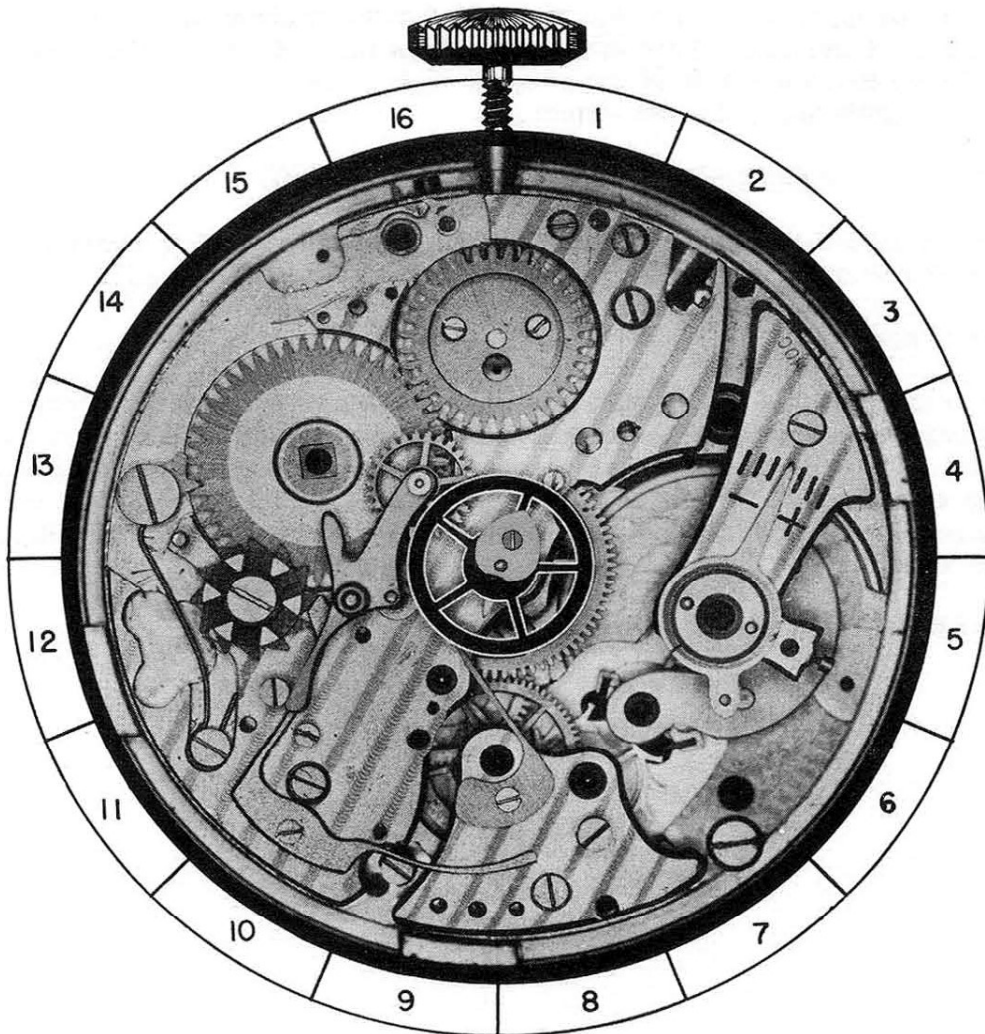

34-A

A. DISASSEMBLY PROCEDURE OF SECONDS WHEEL TENSION SPRING:

The seconds wheel tension spring is held in place by fillister head screw FS-7. When this screw has been removed, the tension spring will be free on plate and may be lifted out of place.

(The shape of screw for this part is shown at bottom of this page.)

B. HAZARDS IN DISASSEMBLY OF SECONDS WHEEL TENSION SPRING:

Be careful when removing this spring. It is a very thin, soft spring and is easily bent or damaged.

C. ASSEMBLY PROCEDURE OF SECONDS WHEEL TENSION SPRING:

Place the tension spring on the plate in the position shown in the photograph. The spring should be placed on the plate, so that end "A" of the spring will be above the level of the plate. Replace fillister head screw FS-7, which holds spring in position. After tightening screw, check again to see that the spring is still in the position, shown in the photograph. The end "A" of spring must not be over the hole for the seconds wheel staff, but alongside of the hole. This is necessary, as the end "A" of the spring should not touch the side of the seconds wheel staff when the seconds wheel is replaced in the movement.

D. FUNCTION OF SECONDS WHEEL TENSION SPRING:

This spring holds an upward tension on the seconds wheel to prevent any irregular jumping or jerking of the seconds wheel as it turns.

REMARKS:

It is important that the tension this spring holds on the seconds wheel be properly adjusted. The seconds wheel tension spring should hold as light a tension as possible on the seconds wheel, and still eliminate any jerky or irregular turning of the seconds wheel. Excess tension of the spring on the seconds wheel causes the seconds wheel to be unnecessarily hard to turn.

REFERENCE: Seconds wheel is Assembly 34.

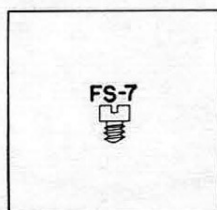

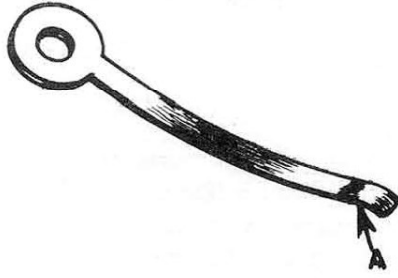

Seconds Wheel Tension Spring
Assembly No. 35

OILING

The seconds wheel tension spring should not be oiled.

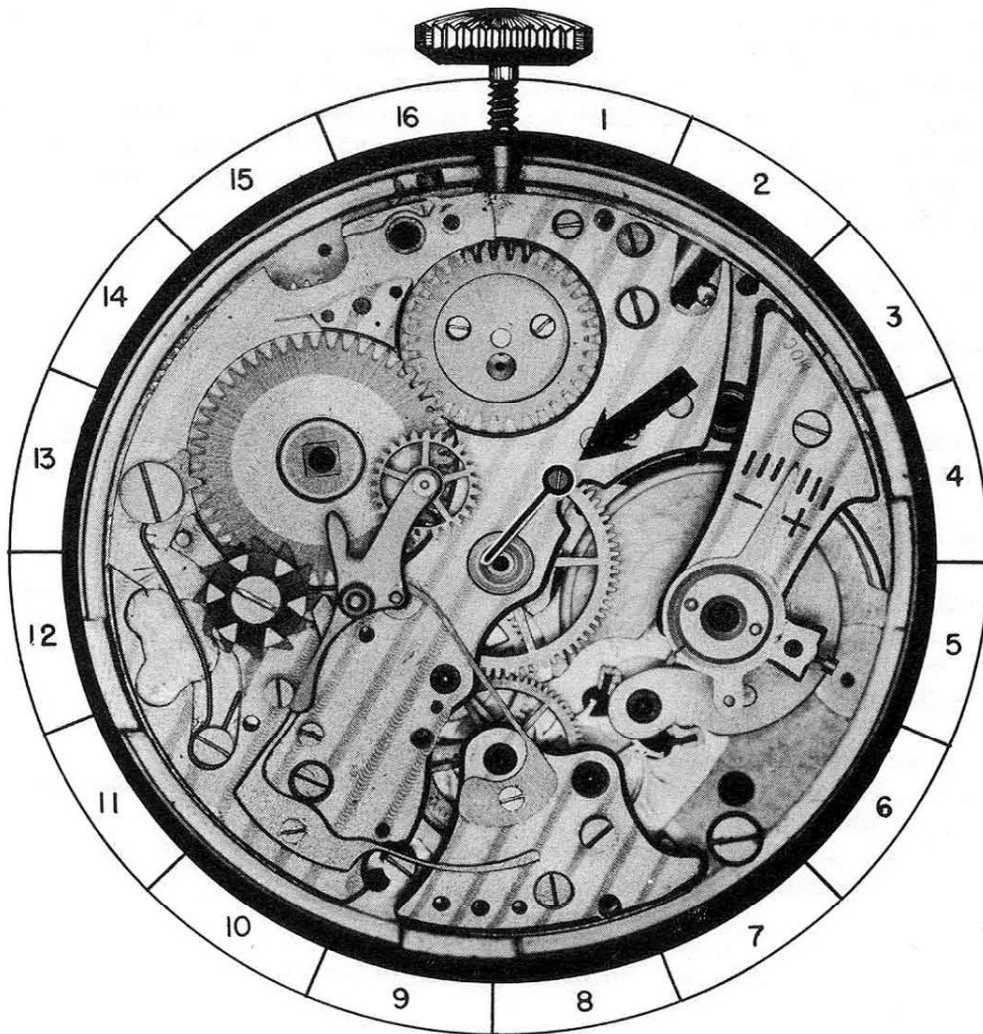

35-A

A. DISASSEMBLY PROCEDURE OF INTERMITTENT LEVER AND WHEEL ASSEMBLY:

The intermittent lever and wheel assembly is held in place by the intermittent lever spring and a post on the plate. To remove this assembly, unhook the end "B" of the intermittent lever spring from the screwhead "C" on the intermittent lever. The intermittent lever may now be lifted free of the post on the plate.

B. HAZARDS IN DISASSEMBLY OF INTERMITTENT LEVER AND WHEEL ASSEMBLY:

When lifting the intermittent lever from post on plate, be sure that the end "B" of the intermittent lever spring is unhooked from the screwhead "C" on intermittent lever; otherwise, the intermittent lever spring will be bent or broken when removing this part.

C. ASSEMBLY PROCEDURE OF INTERMITTENT LEVER AND WHEEL ASSEMBLY:

Place the intermittent lever on this movement in the position shown in the photograph, with the screwhead "C" down, and the hole in the bushing "D" in lever over the post on the plate. Press the lever down until the screwhead "C" rests on the end "B" of the intermittent lever spring. Now move the end "B" of the spring from under the screwhead, and press the intermittent lever down into position. Place the end "B" of the intermittent lever spring between the screwhead "C" and the intermittent lever. The intermittent lever should pivot freely on the post on the plate.

D. FUNCTIONS OF INTERMITTENT LEVER AND WHEEL ASSEMBLY:

The function of the intermittent lever is to engage and disengage the intermittent wheel with the seconds wheel dart tooth.

The function of the intermittent wheel is to transfer the power from the dart tooth to the minute register wheel.

REMARKS:

The intermittent wheel should be carefully checked to see that it has proper endshake and spins freely in the intermittent lever. This wheel must spin freely, as any excess friction on the intermittent wheel may cause the following errors:

1. An incorrect registration of the minutes on the dial.
2. The minute register pawl setting at an incorrect position on minute register wheel.
3. It may cause the watch to stop due to the dart tooth being unable to turn the intermittent wheel.

REFERENCE: Seconds wheel is Assembly 34.
Intermittent lever spring is Assembly 37.

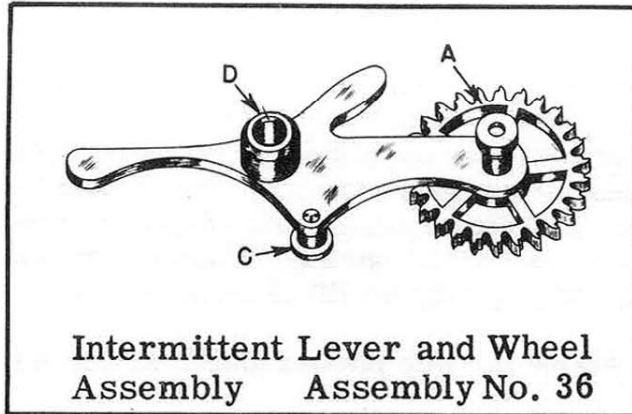

OILING

The following points on the intermittent lever should be slightly moistened with oil:

1. The post on which the intermittent lever pivots.
2. The screwhead "C" at point of contact with the intermittent lever spring.

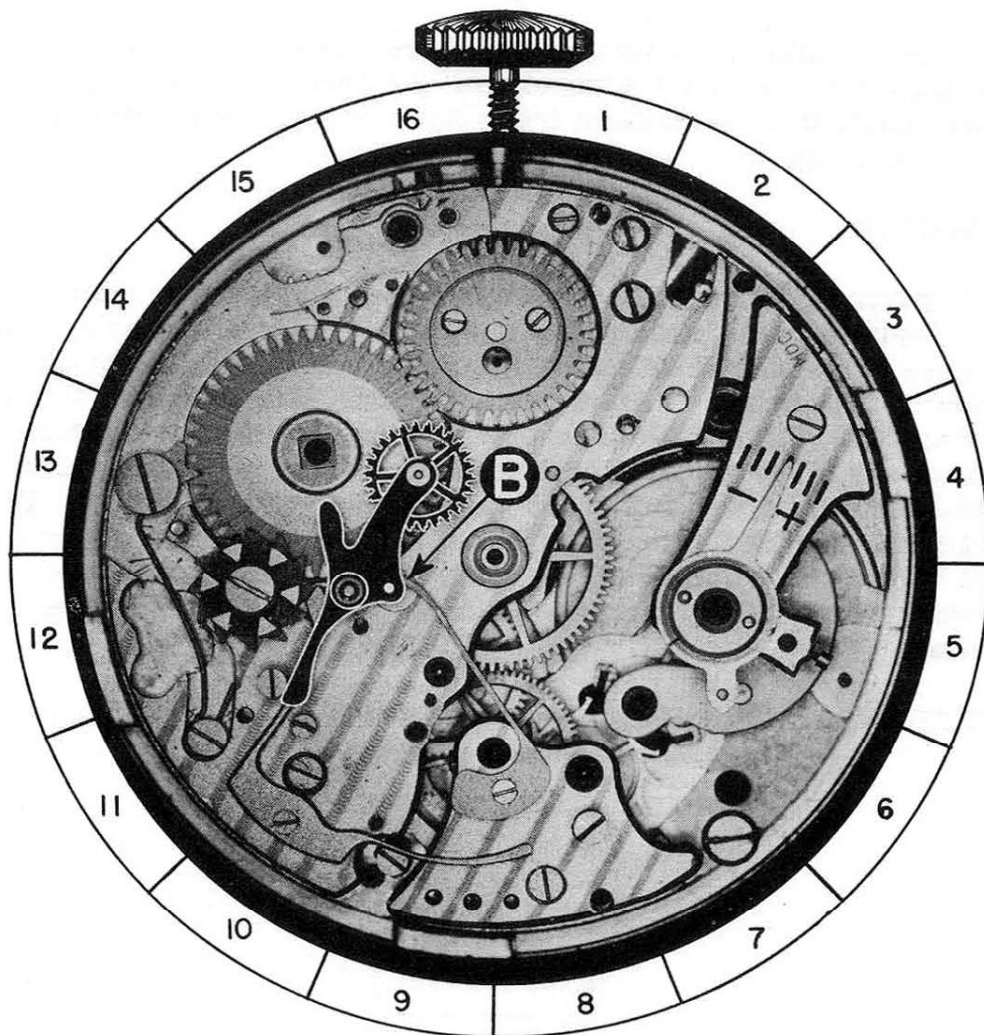

36-A

A. DISASSEMBLY PROCEDURE OF INTERMITTENT LEVER SPRING:

The intermittent lever spring is held in place by beveled countersink screw BS-4, and steady pins. Remove screw, and loosen the spring from the plate by sliding a small thin-bladed screwdriver between the plate and the base of the spring. When the steady pins are free in the plate, the spring may be lifted from the movement.

(The shape of screw for this part is shown at bottom of page.)

B. ASSEMBLY PROCEDURE OF THE INTERMITTENT LEVER SPRING:

Place the spring on the plate in the position shown in the photograph, with the steady pins over the proper holes in the plate. Press the base of the spring down flush on the plate, and replace the beveled countersink screw BS-4, which holds this spring in place.

C. FUNCTION OF INTERMITTENT LEVER SPRING:

This spring holds a tension on the intermittent lever in a direction to engage the intermittent wheel with the seconds wheel dart tooth. It also holds the intermittent lever down on post, preventing it from riding up on the post and coming out of place.

REMARKS:

Many parts of the chronograph mechanism that pivot or turn to perform their function, are held in place by shouldered screws. Each of these parts should be checked to see that the shoulder of the screw properly fits the part. After replacing each of these parts in the chronograph, they should be checked by holding the part with tweezers to see if the part has proper endshake and sideshake; also check at the same time to see that the part is free and not binding. The improper fit of a part to the shoulder of a screw can many times prevent the proper functioning of a part. This makes it absolutely necessary that each part that works under the head of a screw must be checked.

REFERENCE: Intermittent lever and wheel assembly is Assembly 36.
Seconds wheel is Assembly 34.

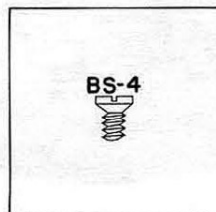

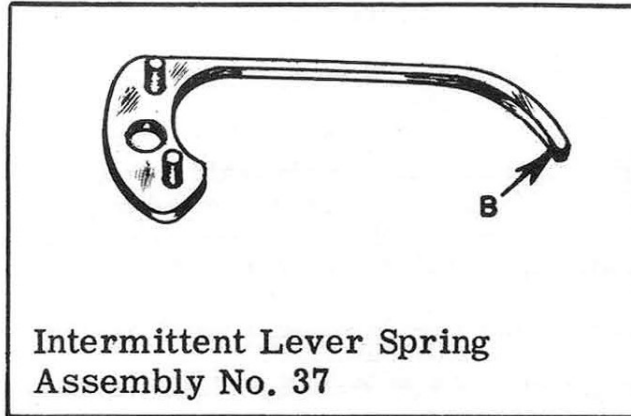

OILING

The intermittent lever spring should not be oiled.

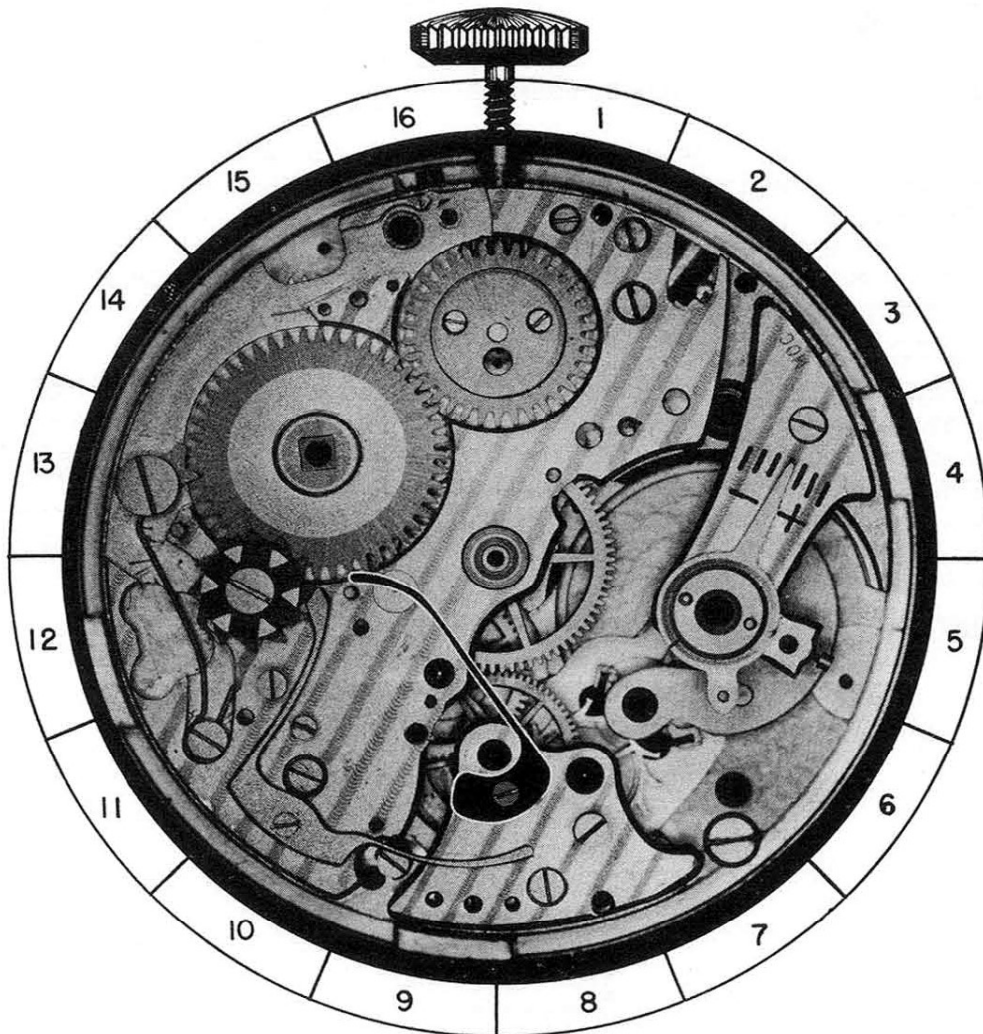

37-A

A. DISASSEMBLY PROCEDURE OF CASTLE WHEEL PAWL AND CHRONOGRAPH PIVOTED DETENT SPRING:

This pawl and spring is held in place by beveled countersink screw BS-5 and steady pins. Remove this screw and loosen part from plate, by sliding a small thin-bladed screwdriver between part and plate. After the steady pins are free in the plate, the part may be lifted from movement.

(The shape of screw for this part is shown at bottom of page.)

B. ASSEMBLY PROCEDURE OF THE CASTLE WHEEL PAWL AND CHRONOGRAPH PIVOTED DETENT SPRING:

Place this pawl and spring on the plate with the steady pins "C" and "D" entering the proper holes in the plate. Then press this part down until the end "A" of the pawl is resting on the ratchet teeth of the castle wheel. Now place the end "A" of the pawl between two ratchet teeth "B" on the castle wheel, and press the part down to the correct position on the plate. Beveled countersink screw BS-5 may now be replaced to hold the pawl and spring in position.

C. FUNCTIONS OF THE CASTLE WHEEL PAWL AND CHRONOGRAPH PIVOTED DETENT SPRING:

The functions of this part are as follows:

1. The pawl correctly spaces the turning of the castle wheel. This prevents the castle wheel from setting at an incorrect position.
2. The pawl holds the castle wheel stationary until it is moved manually.
3. The chronograph pivoted detent spring holds a tension on the chronograph pivoted detent, in a direction which forces the detent to engage the intermediary wheel with the seconds wheel.

REMARKS:

After replacing this pawl and spring, check to see that the ends "A" and "B" are above the plate, and not binding on the plate. All springs in the chronograph that are held in place by steady pins and a screw should be checked to see that the working end of the spring does not bind on the plate. This type of spring should be held securely to the plate at the base of the spring and the working end of the spring should be formed in such a manner that it does not touch the plate from the base to the end of the spring.

REFERENCE: Castle wheel is Assembly 39.
Chronograph pivoted detent is Assembly 23.
Intermediary wheel is Assembly 22.
Seconds wheel is Assembly 34.

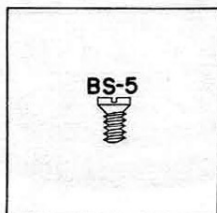

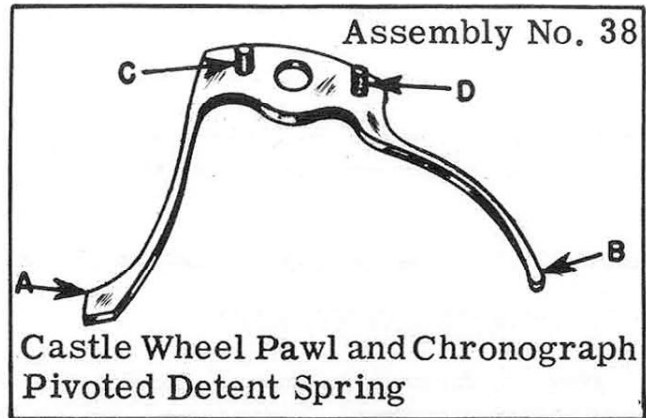

OILING

The castle wheel pawl and chronograph pivoted detent spring should not be oiled.

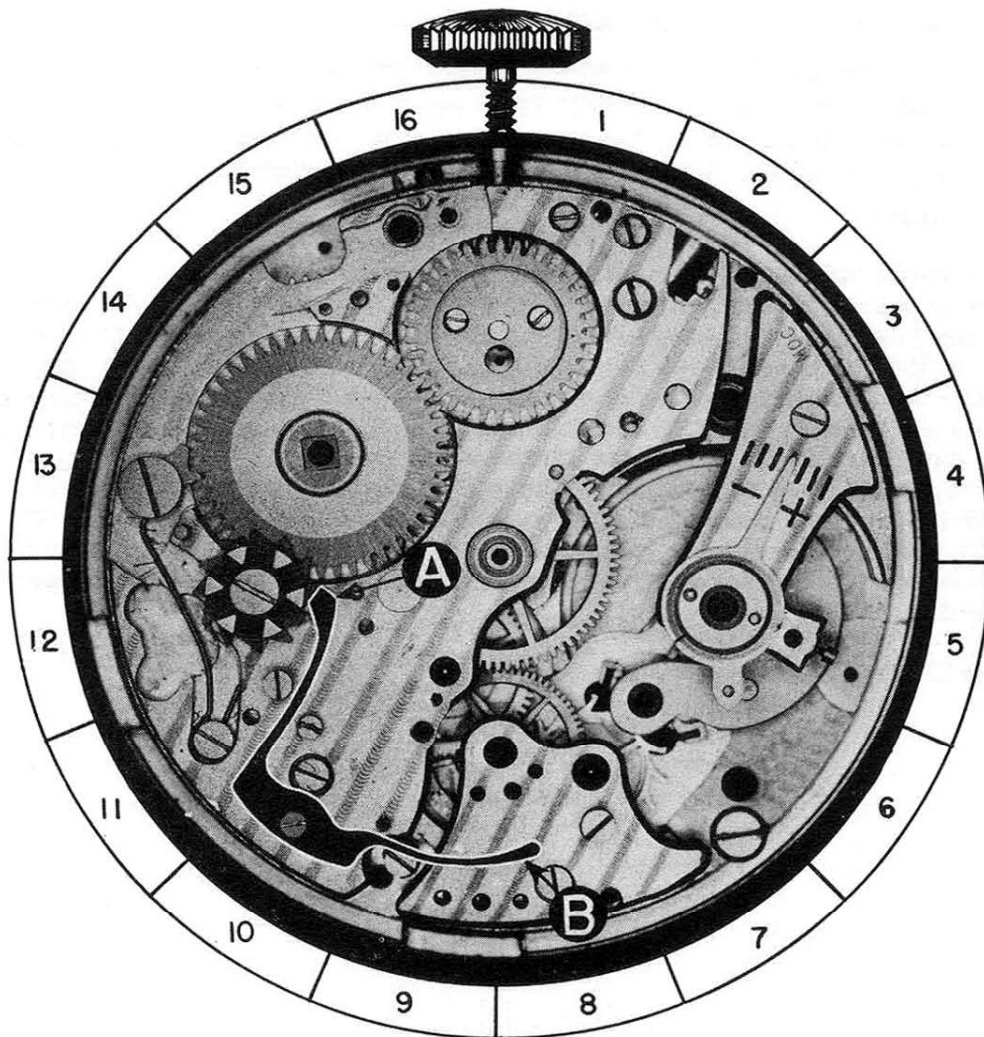

38-A

A. DISASSEMBLY PROCEDURE OF CASTLE WHEEL:

The castle wheel is held in place by shouldered screw SS-16, and pivots on this screw. When screw is removed, the castle wheel may be lifted from the movement.

(The shape of screw for this part is shown at bottom of page.)

B. ASSEMBLY PROCEDURE OF CASTLE WHEEL:

Place the castle wheel on the plate in the position shown in the photograph, and replace shouldered screw SS-16. The castle wheel should turn freely under the head of this screw and yet not have excess freedom.

C. HAZARDS IN ASSEMBLY OF CASTLE WHEEL:

The plate and wheel, where these two parts fit together, should be examined for burrs that could prevent the wheel from turning freely.

D. FUNCTION OF CASTLE WHEEL:

The functions of the castle wheel are as follows:

1. It disengages the intermediary wheel from the seconds wheel.
2. It disengages the brake lever from the seconds wheel.
3. It prevents the flyback lever from being moved towards the center of the watch, when the chronograph mechanism is engaged.

REMARKS:

The castle wheel performs its functions by the columns "A", which are evenly spaced around the center of the wheel. As the castle wheel is turned by the joint hook, the columns either force a part to move out from the center of the castle wheel, or permits a part to move into the empty space between the columns. For example, the intermediary wheel is disengaged from the seconds wheel by the columns of the castle wheel forcing the end of the chronograph pivoted detent bridge out from between the columns, until the point of this lever rests on the column. To engage the intermediary wheel with the seconds wheel, the castle wheel is moved one ratchet tooth. This permits the end of the chronograph pivoted detent bridge to enter the empty spaces between two columns, to engage the intermediary wheel with the seconds wheel.

REFERENCE: Brake lever is Assembly 29.
Flyback lever is Assembly 28.
Intermediary wheel is Assembly 22.
Seconds wheel is Assembly 34.
Joint hook is Assembly 26.

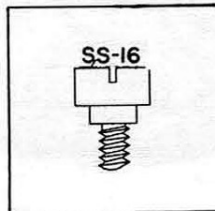

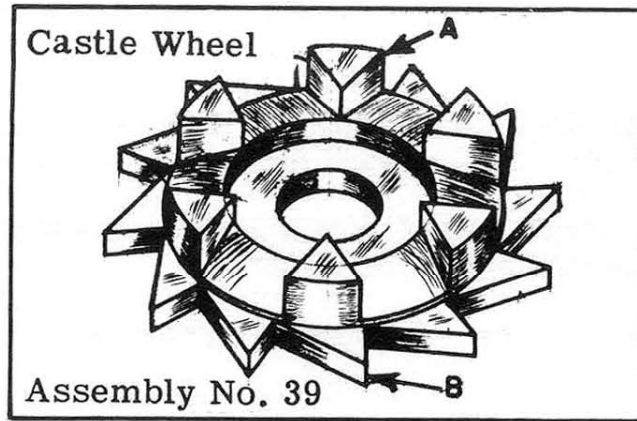

OILING

These parts of the castle wheel should be slightly moistened with oil:

1. The shoulder of screw on which the castle wheel pivots.
2. The columns "A" at points which contact parts of the chronograph mechanism.
3. The castle wheel ratchet teeth "B".

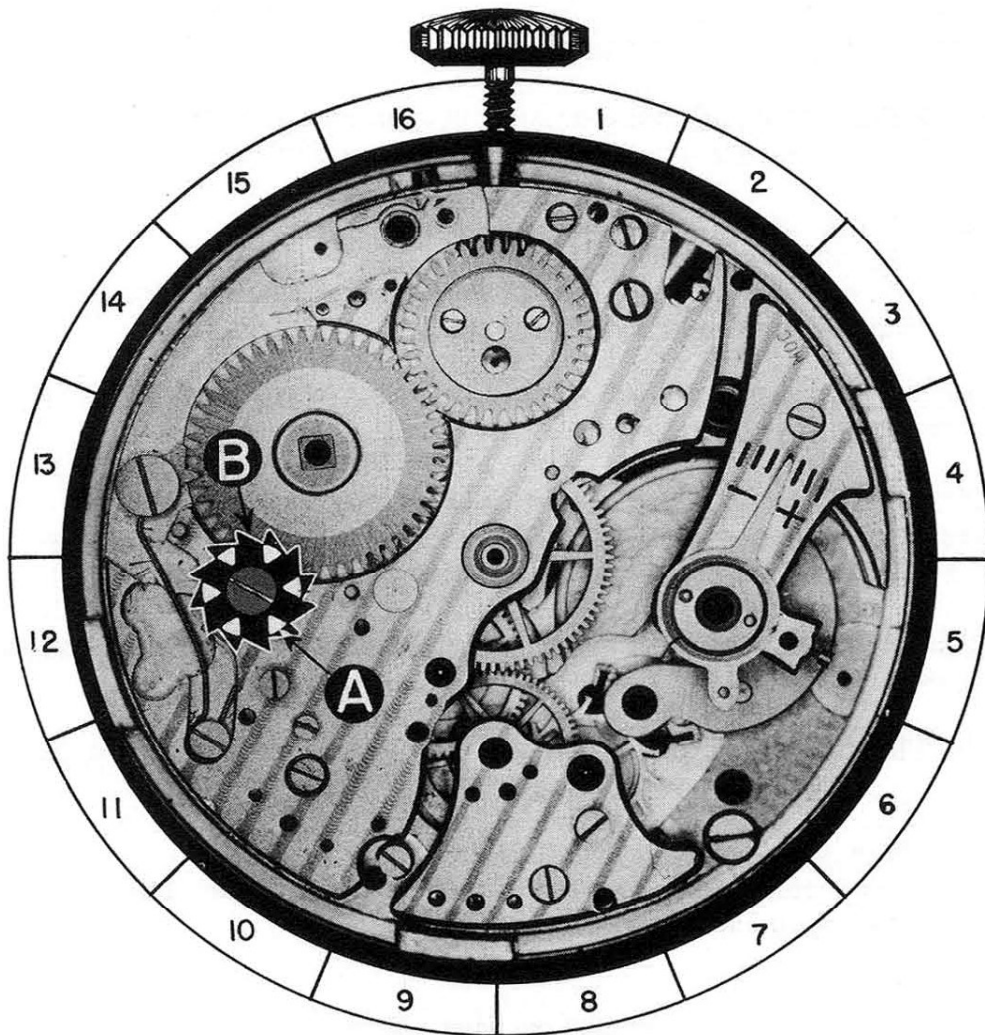

39-A

FUNCTIONAL RESULTS

After completely assembling the chronograph, with the exception of the dial and hands, place the chronograph in front of you, pendant up, with the dial side of the chronograph facing you.

1. **PUSH AND RELEASE THE PUSHER LOCATED APPROXIMATELY 90° TO THE LEFT OF THE PENDANT:**

- A. Check to see that the star wheel of months has moved forward one space.

CORRECTION: The following errors may prevent the star wheel of months from moving forward one space:

- a. Star wheel of months binding.
- b. Month wheel jumper not holding sufficient tension on the star wheel of months.

- B. Check to see that the month wheel detent pusher and the month wheel setting detent have returned to their original positions after being pushed and released.

CORRECTION: The following errors may prevent these parts from returning to their original positions:

- a. Month wheel detent pusher binding.
- b. Month wheel setting detent binding.
- c. Month wheel detent spring not holding sufficient tension on the month wheel setting detent.

2. **PUSH AND RELEASE THE PUSHER LOCATED APPROXIMATELY 90° TO THE RIGHT OF THE PENDANT:**

NOTE: The day and date actuating wheel and cam should not be in a position so that the beak "A" of the cam is forcing the day and date actuating detent to move when the following check is made.

- A. Check to see that the star wheel of days moves forward one space.

CORRECTION: The following errors may prevent the star wheel of days from moving forward one space.

- a. Star wheel of days binding.
- b. Days wheel jumper not holding the proper tension on the star wheel of days.

(Continued on next page)

FUNCTIONAL RESULTS
(Continued)

- B. Check to see that days wheel setting pusher and days wheel setting detent return to their original positions after being pushed and released.

CORRECTION: The following errors may prevent the days wheel setting pusher or detent from returning to their original positions.

- a. Days wheel setting detent binding.
- b. Days wheel setting pusher binding.
- c. Days wheel detent spring not holding enough tension on the days wheel setting detent.

3. PUSH AND RELEASE THE PUSHER DIRECTLY OPPOSITE THE PENDANT:

Note: The day and date actuating wheel and cam should not be in a position so that the beak "A" of the cam is forcing the day and date actuating detent lever to move when the following check is made.

- A. Check to see that the date wheel and the star wheel of days have moved forward one space.

CORRECTION: The following errors may prevent the date wheel or the star wheel of days from moving forward one space.

- a. Day or date wheel binding and not turning freely.
- b. Day or date wheel jumper not holding proper tension on date wheel.
- c. Date wheel not down in proper position.

- B. Check to see that the day and date actuating detent and the day and date setting detent pusher return to their original positions.

CORRECTION: The following errors may prevent these parts from returning to their original positions.

- a. Day and date setting detent pusher binding.
- b. Day and date actuating detent binding.
- c. Day and date actuating detent spring not holding proper tension on the detent.
- d. Day and date setting detent pusher spring not holding proper tension on the pusher.

Note: Now replace the dial and hands on the chronograph. If the chronograph is not in the case at this time, it should be placed in same. Do not replace the back of the case so that the following can be observed and checked.

(Continued on next page)

FUNCTIONAL RESULTS
(Continued)

(Proper method of replacing the chronograph hands is explained on page 47 in this book.)

Place chronograph in front of you, pendant up, with train side facing you.

4. PUSH BUTTON AT LEFT OF PENDANT; HOLD IN THIS POSITION, AND CHECK THE FOLLOWING:

(Make sure that the chronograph mechanism is not engaged so that the button can be pushed.)

- A. Check to see that the seconds wheel and minute register wheel return to a zero position; also check to see that the hands attached to these wheels return to a zero position.

CORRECTION: The following errors may prevent these wheels or hands from returning to a zero position.

- a. Loose hands, or hands not set correctly.
- b. The minute register wheel, intermittent wheel, or seconds wheel binding and not turning freely.
- c. Minute register pawl not properly adjusted.

5. RELEASE BUTTON AND CHECK THE FOLLOWING:

- A. Check to see that the flyback lever returns to its original position.

CORRECTION: The following errors may prevent the flyback lever from returning to its original position.

- a. Flyback lever spring not holding enough tension on flyback lever.
- b. Flyback lever binding.

6. PUSH THE BUTTON AT RIGHT OF PENDANT, RELEASE IT, AND CHECK THE FOLLOWING:

- A. Check to see that the intermediary wheel is engaged with the seconds wheel and the depth of the teeth on these wheels is not shallow.

CORRECTION: The following errors may prevent the intermediary wheel from engaging with the seconds wheel, or cause the depth of the teeth to be shallow.

- a. Chronograph pivoted detent binding.
- b. Chronograph pivoted detent spring not holding the proper tension on the chronograph pivoted detent to engage these wheels.

(Continued on next page)

FUNCTIONAL RESULTS
(Continued)

- c. Improperly adjusted eccentric stud.
(See adjustment of eccentric studs in front of book.)

- B. Check to see that the depth of the intermediary wheel teeth and the seconds wheel teeth is not too deep.

CORRECTION: Improperly adjusted eccentric studs usually result in the teeth of these wheels being depthed too deep.

- C. Check depthing of the intermittent wheel teeth with the seconds wheel dart tooth.

CORRECTION: The following errors may prevent proper depthing of intermittent wheel teeth with dart tooth.

- a. Intermittent lever not turning freely on post in plate.
- b. Intermittent lever spring not holding proper tension on intermittent lever to engage the intermittent wheel with the dart tooth.
- c. Improperly adjusted eccentric stud.
(See adjustment of eccentric studs in front of book.)

REMARKS:

If the depth of the intermittent wheel teeth with the seconds wheel dart tooth is deep, the dart tooth may move the minute register wheel two teeth each time the seconds wheel makes one revolution.

If the depth is shallow, it may result in the minute register wheel not moving a full tooth, and thus, will not register the minutes on the dial.

- D. Check to see that the seconds hand moves forward in a steady manner, with no irregular jumping or jerking.

CORRECTION: The irregular movement of the seconds hand is usually caused by the seconds wheel tension spring not holding enough tension on the seconds wheel.

7. PUSH BUTTON AT RIGHT OF PENDANT A SECOND TIME, RELEASE IT, AND CHECK THE FOLLOWING:

- A. Check to see that the brake lever is in contact with the seconds wheel.

CORRECTION: The following errors may prevent the brake lever from contacting the seconds wheel:

(Continued on next page)

FUNCTIONAL RESULTS
(Continued)

- a. Brake lever not turning freely under head of screw.
- b. Brake lever spring not holding proper tension on brake lever.

8. LET THE POWER DOWN ON THE MAINSPRING, AND THEN TURN THE CROWN A FEW TIMES UNTIL THE MAINSPRING IS ABOUT 1/4 WOUND UP.

(The hands should not indicate the time to be between 10:30 and 2, and the chronograph mechanism should be disengaged for this check.)

- A. Check the oscillation of the balance wheel and make a mental note of the degree of oscillation, as the degree of oscillation at this time will be used as a basis for the next two checks.

9. PUSH AND RELEASE THE BUTTON AT THE RIGHT OF THE PENDANT TO ENGAGE THE CHRONOGRAPH, AND CHECK THE FOLLOWING:

- A. Check to see that the oscillation of the balance is not greatly reduced. Particular attention should be given when the dart tooth is not turning the intermittent wheel.

CORRECTION: The following errors may reduce the oscillation of the balance when the dart tooth is not turning the intermittent wheel.

- a. Seconds wheel tension spring holding too strong a tension on the seconds wheel.
- b. Seconds wheel tension spring rubbing against the side of the seconds wheel post.
- c. Depthing of the wheel over fourth wheel teeth with the intermediary wheel teeth too deep.
- d. Depthing of the intermediary wheel teeth with the seconds wheel teeth too deep.
- e. Seconds wheel binding and not turning freely.
- f. Sweep second hand not properly adjusted, and rubbing on the crystal or dial, or catching on other hands.

- B. While the dart tooth is turning the intermittent wheel, check to see that the oscillation of the balance wheel is not greatly reduced.

CORRECTION: The following errors may greatly reduce the oscillation of the balance wheel while the dart tooth is turning the intermittent wheel.

(Continued on next page)

FUNCTIONAL RESULTS
(Continued)

- a. Minute register pawl holding too strong a tension on minute register wheel.
 - b. Intermittent wheel binding.
 - c. Minute register wheel binding and not turning freely.
 - d. Minute register hand rubbing on dial or another hand.
10. WITH THE WATCH IN SETTING POSITION, TURN THE HANDS CLOCKWISE UNTIL THE DATE HAND AND THE STAR WHEEL OF DAYS START TO MOVE FORWARD TO INDICATE ANOTHER DAY AND DATE. NOW PLACE IN WINDING POSITION AND CHECK THE FOLLOWING:

A. Check to see that the oscillation of the balance wheel has not been greatly reduced, or stopped.

CORRECTION: The following errors may greatly reduce the oscillation of the balance wheel, or cause it to stop.

- a. Date wheel binding and not turning freely.
- b. Date wheel jumper holding too strong a tension on date wheel.
- c. Date hand not properly adjusted, rubbing on dial or another hand.
- d. Star wheel of days binding and not turning freely.
- e. Days wheel jumper holding too strong a tension on the star wheel of days.
- f. Day and date actuating detent lever spring holding too strong a tension on the day and date actuating detent lever.

REMARKS:

First, when checking the functional results, it should be remembered that it may not be one error alone which may cause the chronograph not to function properly. It may be that there is a slight error which may not in itself cause the chronograph to function incorrectly, but a combination of this one small error, plus one or more small errors may result in the chronograph not functioning correctly. This makes it imperative that each individual check be given full consideration, and proper steps taken to eliminate any error before proceeding to the next check.

DIRECTIONS FOR READING A CHRONOGRAPH DIAL

TACHOMETER SCALE

- A. A tachometer scale is used to indicate the speed of an object in miles per hour. A tachometer can only indicate the average speed of an object traveling the course of a measured mile.

METHOD OF USING A TACHOMETER

1. Start the chronograph sweep second hand at the exact moment the object to be timed starts to travel the measured distance of one mile.
2. When the object has traveled the course of one mile, stop the chronograph sweep second hand. The point on the tachometer scale where the sweep second hand stopped will indicate in miles per hour the average speed of the object over the measured mile.

SECOND HAND

- B. The second hand indicates the passing of seconds and should move one space each second. One complete revolution of the hand denotes the passing of one minute. This hand is independent of the chronograph mechanism, and continues to register the seconds as long as the watch is running.

SPLIT SECOND SCALE

- C. This scale is divided into 300 divisions, each division indicating $\frac{1}{5}$ of a second. Every fifth division is marked with extra long lines denoting one second. The main purpose of this scale is to measure a fraction of a second accurately.

MONTH TRACK

- D. The purpose of the month track is to indicate the month of the year on the dial. This track is manually controlled, and must be corrected at the end of each month.

MINUTE REGISTER

- E. The minute register hand indicates on the dial the number of minutes that have elapsed since the beginning of the registration of the sweep second hand. One complete revolution of the minute hand indicates the passage of 45 minutes.

DATE TRACK

- F. The purpose of the date track is to indicate the date on the dial. The date hand is mechanically controlled by the calendar mechanism and will automatically change the date each 24 hours. The date hand can also be set manually to indicate the correct date on the dial.

DAY OF WEEK TRACK

- G. The day of the week track indicates the day of the week on the dial. This track is automatically controlled by the calendar mechanism and will automatically change the day of the week each 24 hours. Also, the day of the week track can be set manually to indicate the correct day by pushing the button which is provided for this purpose.

THE CHRONOGRAPH DIAL

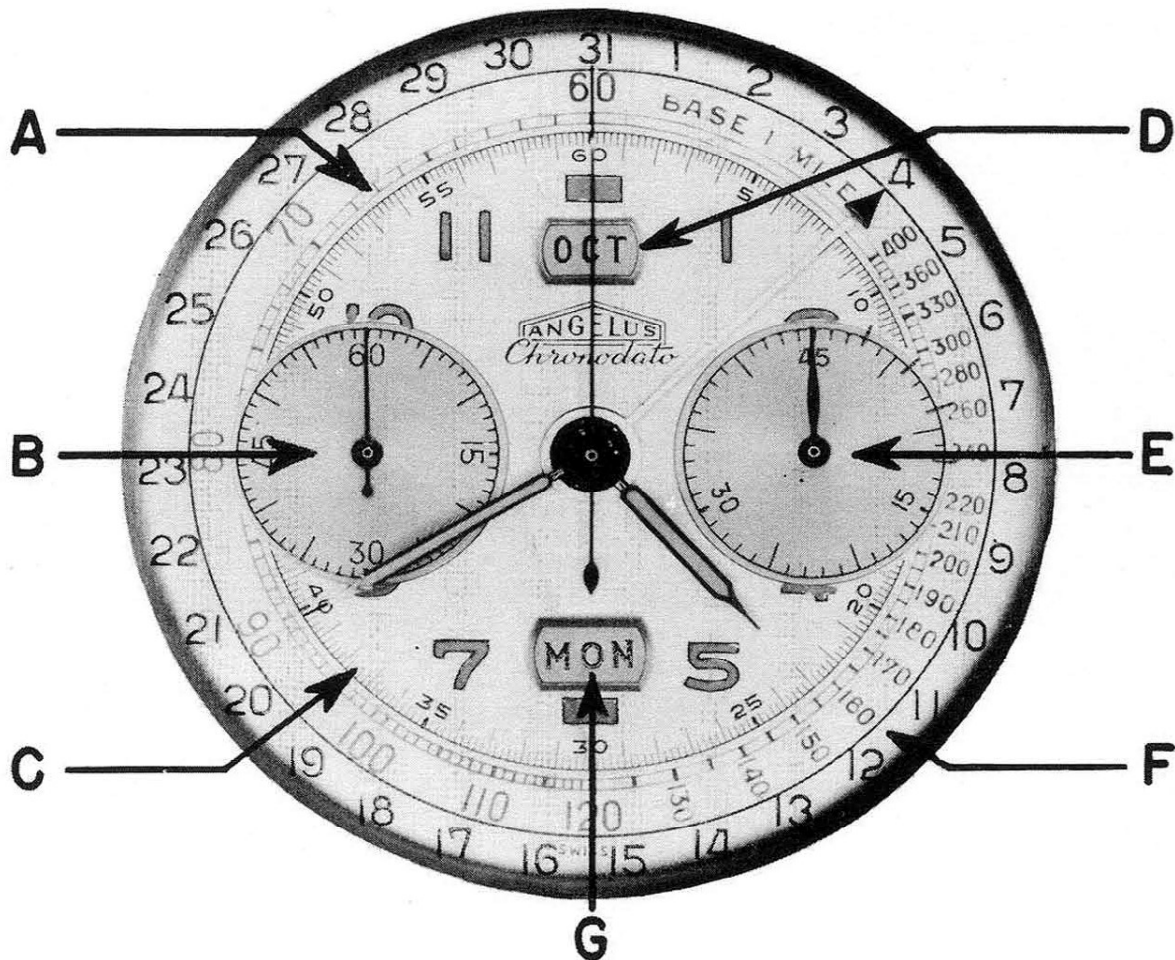

SETTING THE HANDS CORRECTLY ON A CHRONOGRAPH CALENDAR WATCH

After the chronograph is repaired, assembled, and the dial replaced, the hands should be replaced as explained in the following:

1. Replace the date hand, with the hand centered on any one of the numerals on the date scale "F".
2. Pull out the crown to setting position, and turn the crown clockwise until the date hand starts to move forward to the next numeral. Stop turning the crown.
3. Replace the hour hand and minute hand to indicate 12:00 o'clock. The hands are now set for 12:00 o'clock midnight. Now turn the crown clockwise until the hour hand has completed two revolutions and is back at 12:00 o'clock midnight. Then check to see if the date hand has started to move forward to indicate the following date.
4. Push the button to force the flyback lever to return the seconds wheel and minute register wheel to zero. While the flyback lever is holding these wheels at a zero position, replace the minute register hand at 45 on the minute register track "E", and the sweep second hand at 60 on the split second track "C". The flyback lever may now be released. The chronograph should be engaged and let run for a period of time, then the hands returned to zero. This should be repeated several times to make sure that the chronograph hands consistently return to a zero position.
5. When the hands are replaced, and the chronograph is in the case, the calendar mechanism can be set to indicate the correct month, day, and date, by pushing and releasing the pushers which control the manual setting of this mechanism.