

WORLD'S ONLY
FULLY ILLUSTRATED
CHRONOGRAPH WATCH COURSE
VOLUME 6

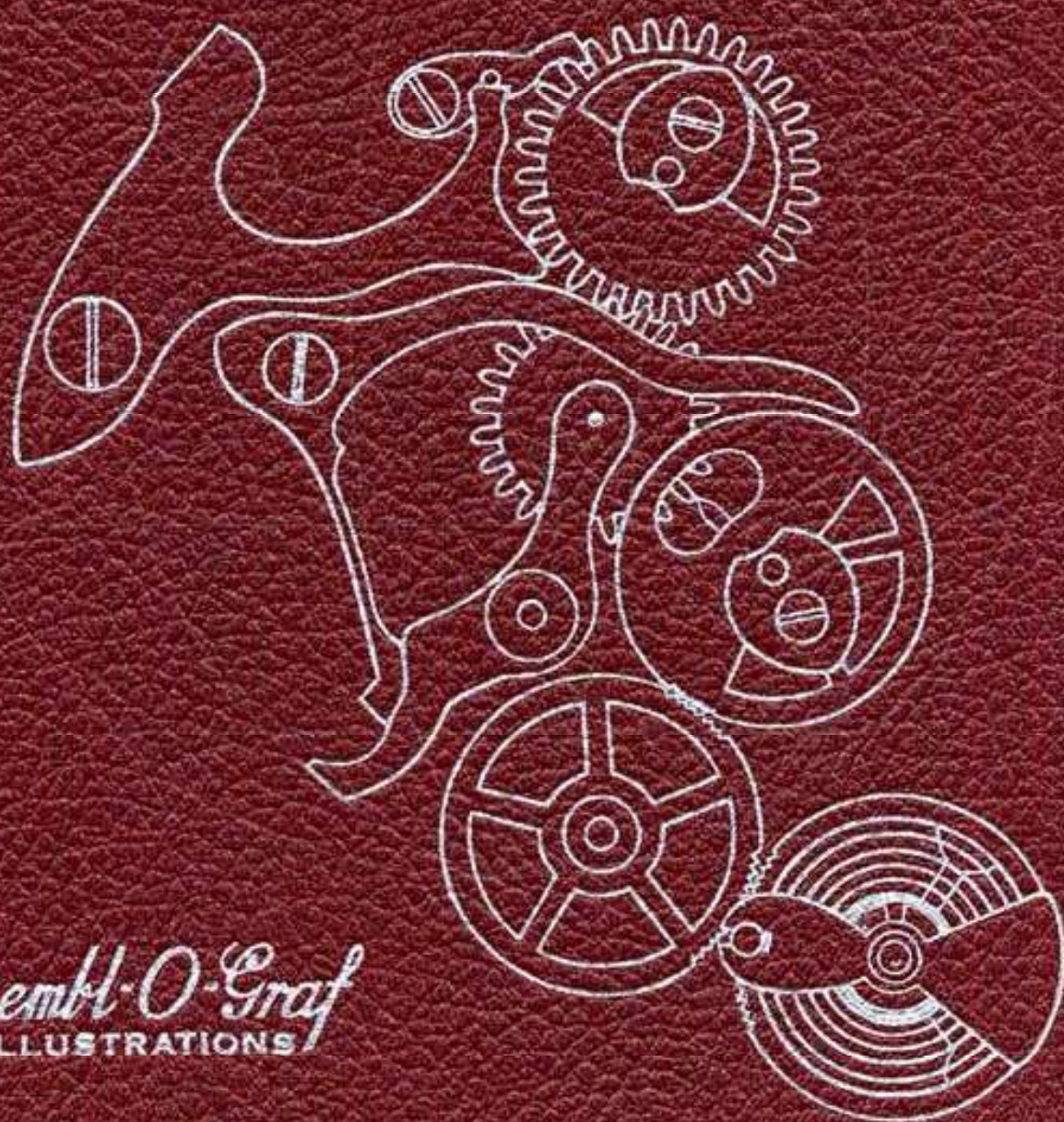

Essemb-O-Graf
ILLUSTRATIONS

IDENTIFICATION OF DATO-GRAPH

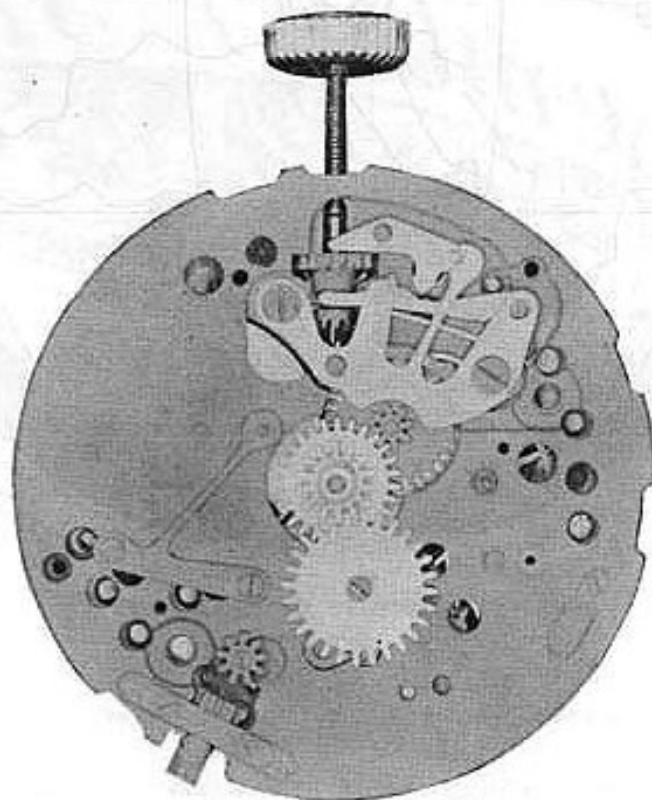

11 1/2 L



120

FONTAINEMELON

CAL. 205



ESEMBL-O-GRAF

THE WORLD'S FIRST FULLY
ILLUSTRATED TEXT BOOK
ON
CHRONOGRAPH REPAIRING
AND ADJUSTING

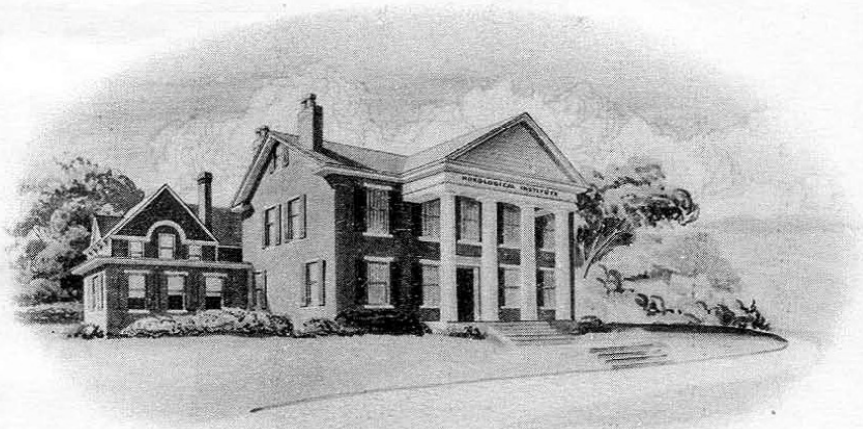

BY
William O. Smith, Sr.
PRESIDENT AND TECHNICAL DIRECTOR
AND
William O. Smith, Jr.
CHIEF ENGINEER, RESEARCH LABORATORIES

WESTERN PENNSYLVANIA HOROLOGICAL INSTITUTE, INC.
PITTSBURGH, PENNSYLVANIA

INSTRUCTIONS For use of book

DISASSEMBLY OF THE CHRONOGRAPH MECHANISM:

1. Study the isometric drawing at top of page 1-A. The isometric drawing was made for the following purposes:
 - A. It helps to identify the part to be removed.
 - B. This drawing aids in pointing out certain locations on the part that are mentioned in the oiling procedure.
 - C. The text refers to certain points on the part. These points are shown in the isometric drawing. This should aid you in finding the exact location on the part that is described in the text.
 - D. It helps you to know the shape of the part in case a new part has to be made.
2. At the bottom of the page 1-A is a photograph of a chronograph. In this photograph is the same part painted in black. The part is in its exact location that this part occupies in the watch. Find this location in the watch.
3. Read the disassembly procedure and the hazards in disassembly on page 1 in this book.
4. Remove this part in the same procedure as described in the text.
5. A very important item in disassembling a chronograph is keeping the screws in order, much time will be lost in putting the chronograph together if screws are mixed up. This means you have to hunt for each screw, sometimes trying three or four screws before finding the correct one. It cannot be stressed too strongly that care should be taken so that screws are not mixed up. The system that we advise for beginners, is to replace each individual screw after each part is removed. This naturally eliminates the hazard of mixing up the screws and will save you much time in the end. Do this at least until you become so thoroughly familiar with the chronograph that you no longer feel it is necessary.
6. Continue to follow this procedure throughout the book and disassemble each part until the last part of the chronograph is removed.

ASSEMBLY OF THE CHRONOGRAPH MECHANISM:

7. When you are ready to assemble the chronograph mechanism, study the isometric drawing on the last part in this book. This drawing should aid you in identifying the part to be assembled.
8. At the bottom of this page is a photograph of a chronograph. In this photograph is the same part painted in black. The part is in its exact location that this part occupies in the watch.
9. Read the assembly procedure and the hazards in assembling for the last part in this book. (Continued on next page)

INSTRUCTIONS

(Continued)

10. Replace the part in its exact location as shown in photograph, using the procedure as described in the text.

11. After you find the correct location for this part in the watch, read the oiling procedure for this part. The oiling procedure for this part is located underneath the isometric drawing. It is best to read the oiling procedure before you put each part in place as there are certain parts that must be oiled immediately as it may prove difficult to oil them later.

12. Replace the screw that holds this part in place. Of course, the screws should be kept in order as we advised above, but if the screws are not in order or the watch was received with screws mixed up, you will find a screw drawn for each part that requires a screw at the bottom of the text page.

13. After replacing this part, replace the next part, etc., until the last part is replaced, which will be part No. 1. Each part should be replaced using the same procedure as described in the text.

(Naturally, the assembly of the chronograph is exactly the reverse of the disassembly)

14. After disassembling and assembling the chronograph mechanism, start on page 1 and read the function of this part. After reading the function of this part, continue to read the function of each part throughout the book. Study each part, one at a time. This text should help you to understand more fully the purpose of each part in the chronograph mechanism.

15. Now put movement in its case with dial on, then replace hands.

16. Study the text on functional results in this book, and check the chronograph mechanism as described in this text.

NOMENCLATURE OF PART FOR CHRONOGRAPH MECHANISM





17. After you have become familiar with the chronograph mechanism, you can disassemble and assemble the chronograph by using the nomenclature of parts as a guide. This makes it possible for you to use a procedure without going through each page in the book.

18. ADJUSTMENT OF ECCENTRIC STUDS:

Read the text on adjustment of eccentric studs, this text should be read in reference to the eccentric stud picture. Now adjust each eccentric stud one at a time in the watch, as described in the text. Use the picture to show you the position of these studs.

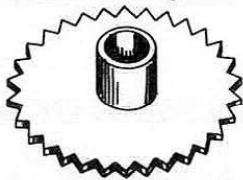
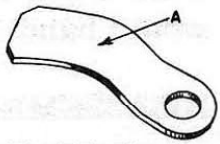
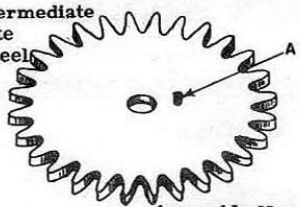
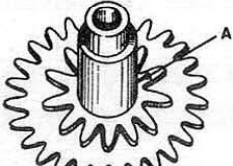
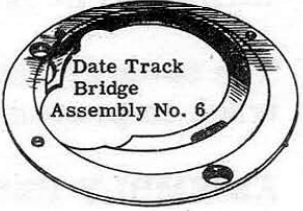
19. On each page in this book the part number and the page number are the same. This makes it convenient for the reader and eliminates any confusion.

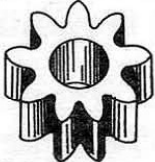
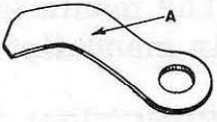
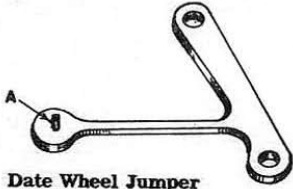
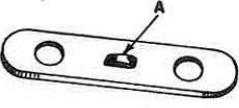
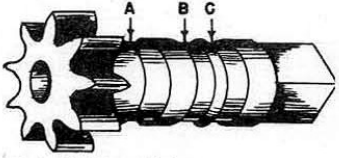
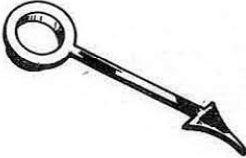
NOMENCLATURE OF PARTS FOR DATE - O - GRAPH MECHANISM

 <p>Month Track Assembly No. 1</p>	<p>Date Wheel Assembly No. 2</p> 	 <p>Month Track Tension Spring Assembly No. 3</p>
<p>Intermediate Date Wheel Assembly No. 4</p> 	<p>Hour Wheel with Hairing Wheel Assembly No. 5</p> 	 <p>Date Track Bridge Assembly No. 6</p>
 <p>Date Track Assembly No. 7</p>	<p>Intermediate Month Setting Wheel Assembly No. 8</p> 	 <p>Date Track Tension Assembly No. 9</p>
<p>Date Wheel Jumper Assembly No. 10</p> 	<p>Date Pinion Bridge Assembly No. 11</p> 	<p>Date Setting Pinion Assembly No. 12</p> 
 <p>Date Hand</p>	 <p>Date Setting Stem</p>	

PART NO. 1

A. HAZARDS IN DISASSEMBLY OF THE MONTH TRACK:

The tweezers should be carefully used when removing the month track as it is very easily marred or scratched. This track should be handled with the same care that you would handle a dial.

B. DISASSEMBLY PROCEDURE OF MONTH TRACK:

The month track fits in a recess in the date track bridge. It is simply lifted out of place to remove it.

C. HAZARDS IN ASSEMBLY OF MONTH TRACK BRIDGE:

The tweezers must be carefully used when handling month track to prevent scratching or marring of track.

D. ASSEMBLY PROCEDURE OF MONTH TRACK:

Place month track in recess in date track bridge. This recess acts as a guide to keep the month track in place. The month track is held in position by the dial. This track is manually controlled.

E. FUNCTION OF MONTH TRACK:

Function of this track is to indicate the month on the dial.

REFERENCE: Date track bridge is Assembly 6.

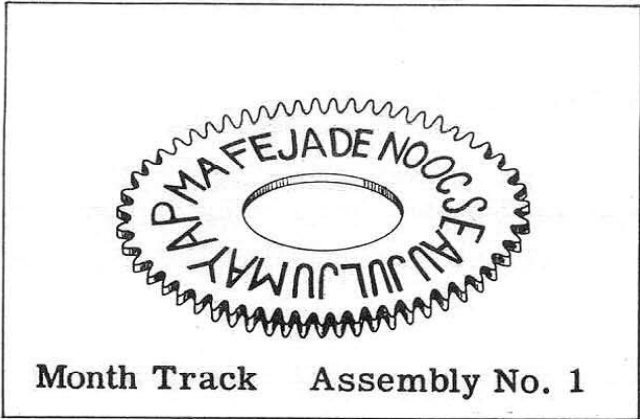

OILING

The month track should not be oiled.

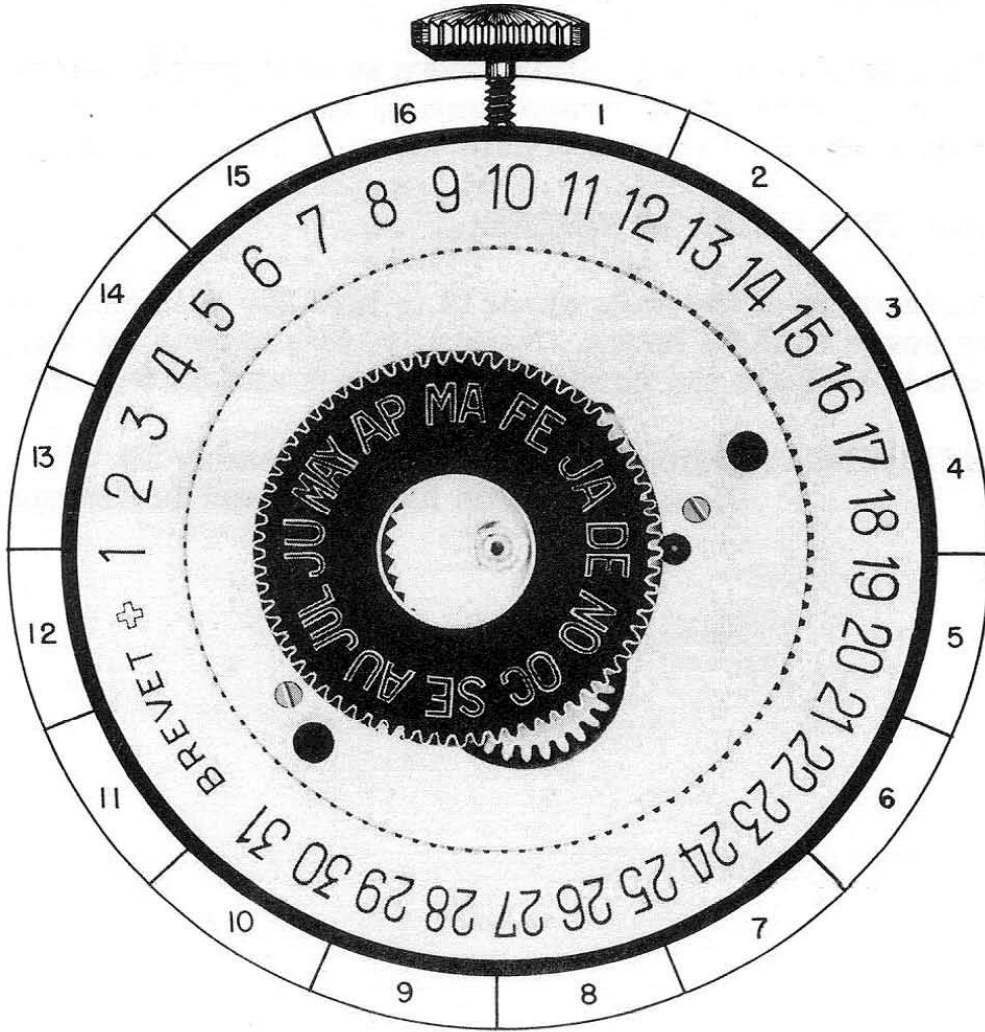

1-A

PART NO. 2

A. DISASSEMBLY PROCEDURE OF DATE WHEEL:

To remove the date wheel it is simply lifted out of place. The same procedure should be used in removing date wheel that you normally use in removing the hour wheel from a watch.

B. HAZARDS IN ASSEMBLY OF DATE WHEEL:

The date wheel should not be pressed down flush on plate until pin 'A' on date wheel jumper is meshing in teeth on date wheel. The date wheel should not fit tight on hour wheel with hairing wheel but should turn freely when not held stationary by jumper.

C. REPLACING PROCEDURE OF DATE WHEEL:

Place date wheel in position shown in photograph. Move pin 'A' on date wheel jumper until it meshes with teeth on date wheel. Now press date wheel to proper position.

D. FUNCTION OF DATE WHEEL:

The function of the date wheel is to turn the date hand forward one space each 24 hours. Naturally, this causes the date hand to indicate the correct day of week and date on the dial.

REFERENCE: Date wheel jumper is Assembly 10.
Hour wheel with hairing wheel is Assembly 5.

Date Wheel Assembly No. 2

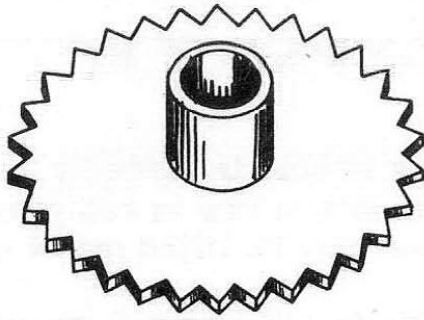

OILING

The date wheel should not be oiled.

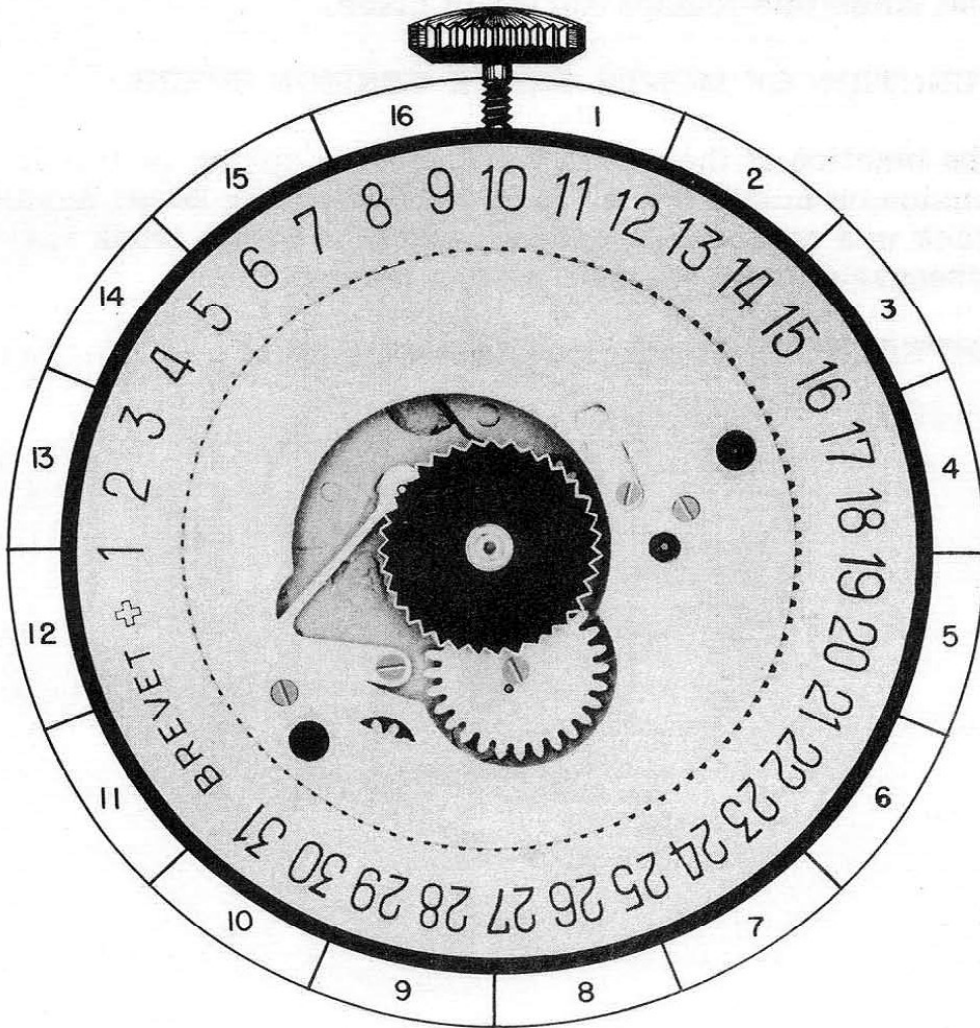

2-A

PART NO. 3

A. DISASSEMBLY PROCEDURE OF MONTH TRACK TENSION SPRING:

This tension spring is held in place by beveled countersink screw BS-1. When this screw is removed, tension spring will be free on plate and may be lifted out of place.

(The shape of screw for this part is shown at bottom of page)

B. ASSEMBLY PROCEDURE OF MONTH TRACK TENSION SPRING:

Place month track tension spring in its proper position on plate as shown in photograph. The side "A" of spring must be placed up. Now replace beveled countersink screw BS-1 that holds this tension spring in place.

C. FUNCTION OF MONTH TRACK TENSION SPRING:

The function of the month track tension spring is to hold a tension on month track. This tension spring keeps month track in a stationary position, when the month track is disengaged from the date setting mechanism.

REFERENCE: Month track is Assembly 1.

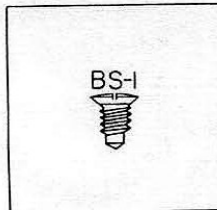

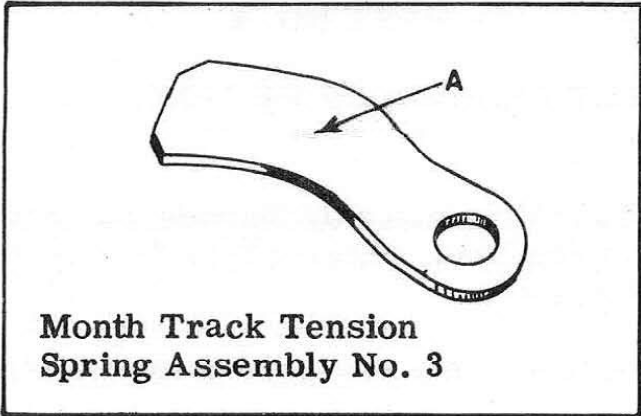

OILING

The month track tension spring should not be oiled.

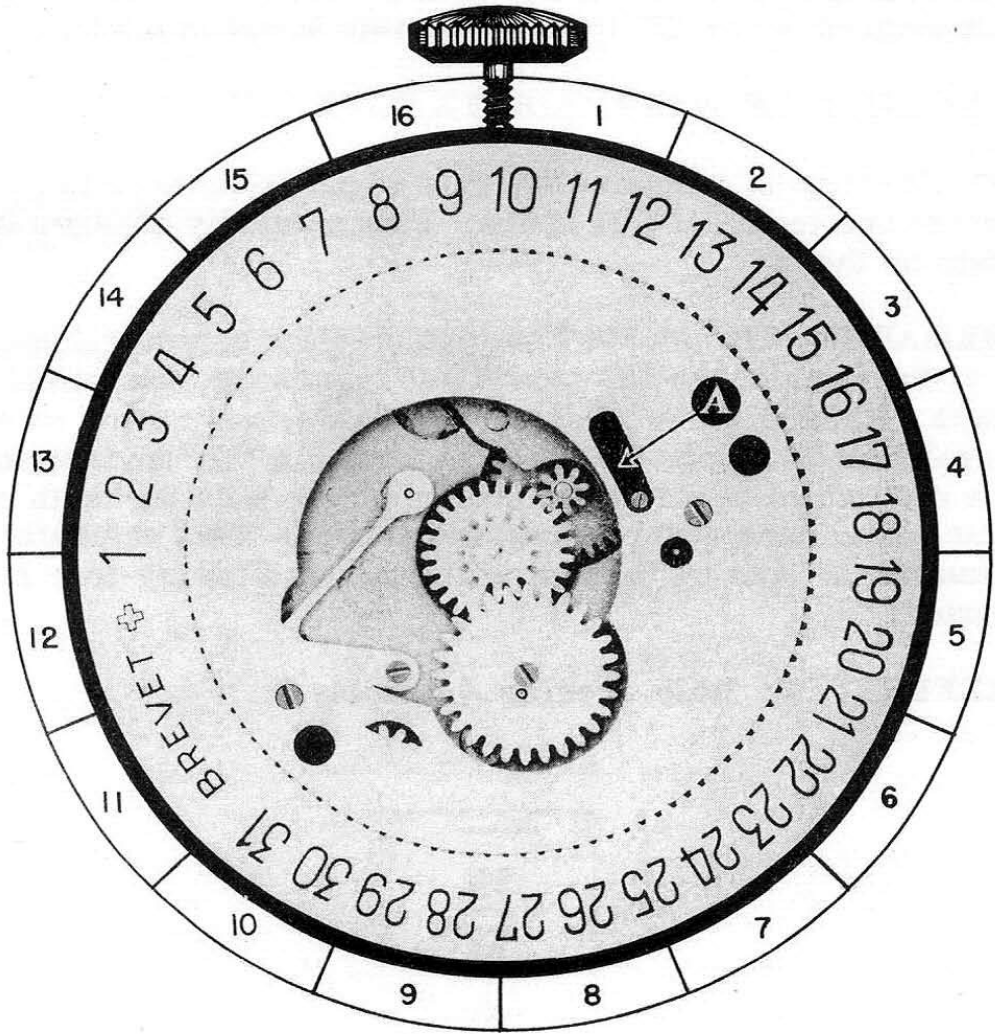

3-A

PART NO. 4

A. DISASSEMBLY PROCEDURE OF INTERMEDIATE DATE WHEEL:

This wheel is held in place by shouldered screw SS-1. When this screw is removed, wheel will be free on plate and may be lifted out of place.

(The shape of screw for this part is shown at bottom of page)

B. ASSEMBLY PROCEDURE OF INTERMEDIATE DATE WHEEL:

Place intermediate date wheel in its proper position on plate. In this type of Date-O-Graph mechanism you do not have to bother with setting the pin "A" on intermediate date wheel at any particular position, just replace intermediate date wheel in its proper position as shown in photograph, then replace shouldered screw SS-1 that holds this wheel in place.

C. FUNCTION OF INTERMEDIATE DATE WHEEL:

The function of intermediate date wheel is to move the date wheel one tooth each 24 hours. This naturally changes the date on the dial.

REMARKS: The pin "A" on intermediate date wheel meshes into the teeth of the date wheel and moves the date wheel one tooth. Naturally, the intermediate date wheel makes only one revolution in twenty-four hours so the pin "A" on intermediate date wheel could only move or engage with the teeth on the date wheel once every twenty-four hours. This naturally, changes the date on the dial at the end of a twenty-four hour period.

REFERENCE: Date wheel is Assembly 2.

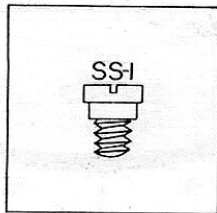

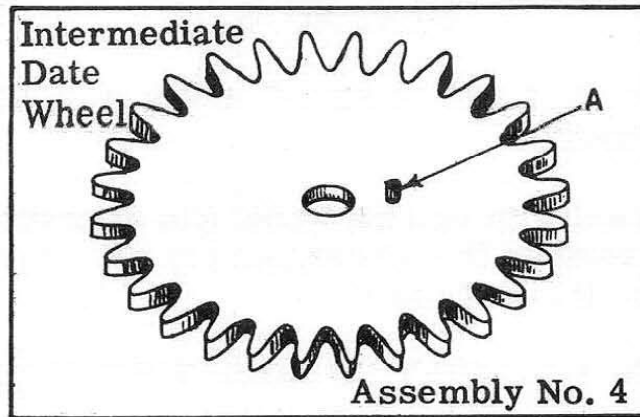

OILING

The shouldered screw that intermediate date wheel pivots on should be slightly moistened with oil.

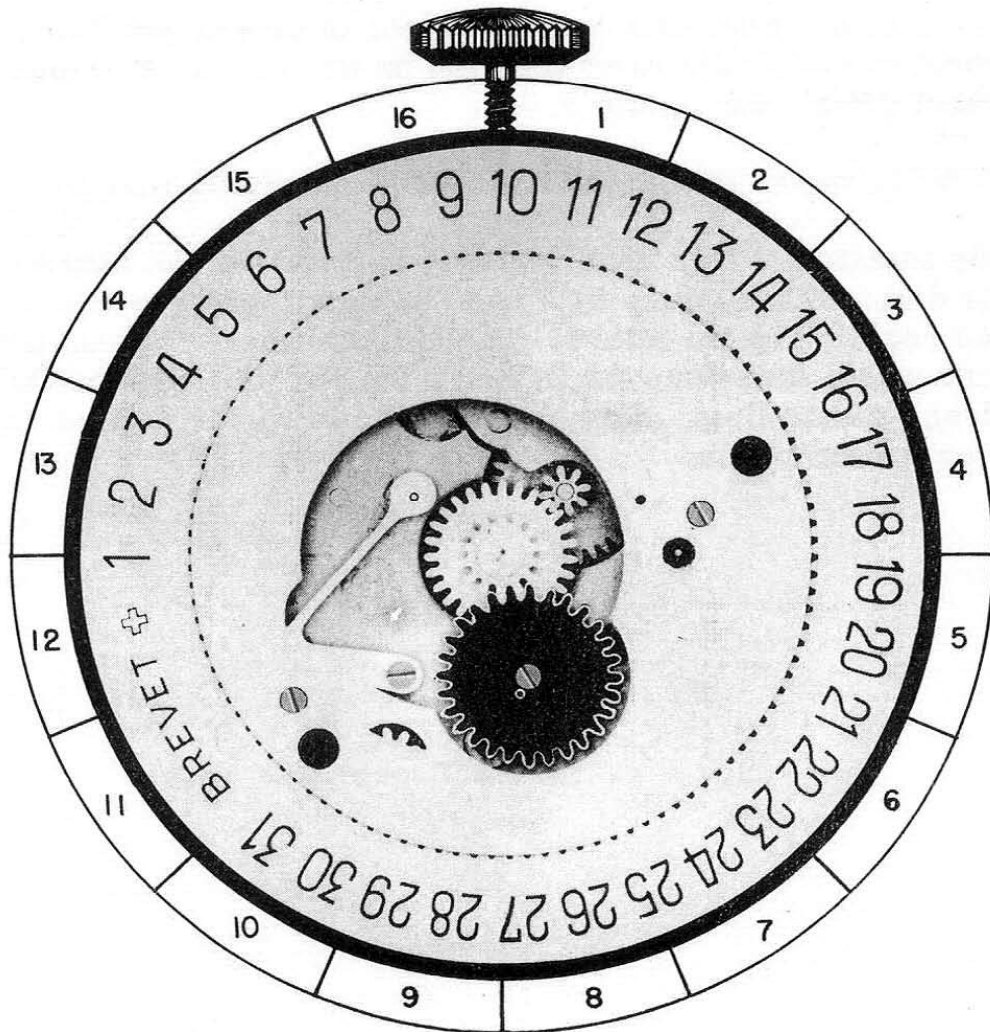

4-A

PART NO. 5

A. DISASSEMBLY PROCEDURE OF HOUR WHEEL WITH HAIRING WHEEL:

The hour wheel with hairing wheel fits over the cannon pinion. To remove this wheel, simply lift straight up on wheel, lifting it out of place.

B. HAZARDS IN ASSEMBLY OF HOUR WHEEL WITH HAIRING WHEEL:

This part should not fit tight on cannon pinion but should turn freely with no binding on cannon pinion.

C. ASSEMBLY PROCEDURE OF HOUR WHEEL WITH HAIRING WHEEL:

Place hour wheel with hairing wheel in proper position. This wheel fits over the cannon pinion on the watch. Now push wheel down flush on plate.

D. FUNCTION OF HOUR WHEEL WITH HAIRING WHEEL:

The function of this hour wheel is to register the hours on the dial. This is done by a hand being attached to this wheel and registering the hours. The hairing wheel "A" on the hour wheel transfers the power from the watch to the Date-O-Graph mechanism. This wheel makes two revolutions in twenty-four hours.

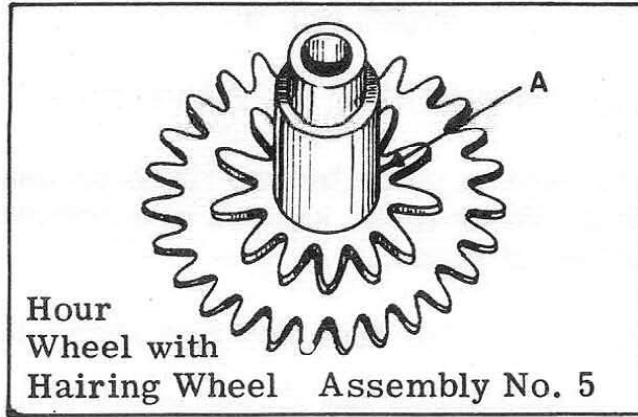

OILING

The hour wheel with hairing wheel should not be oiled.

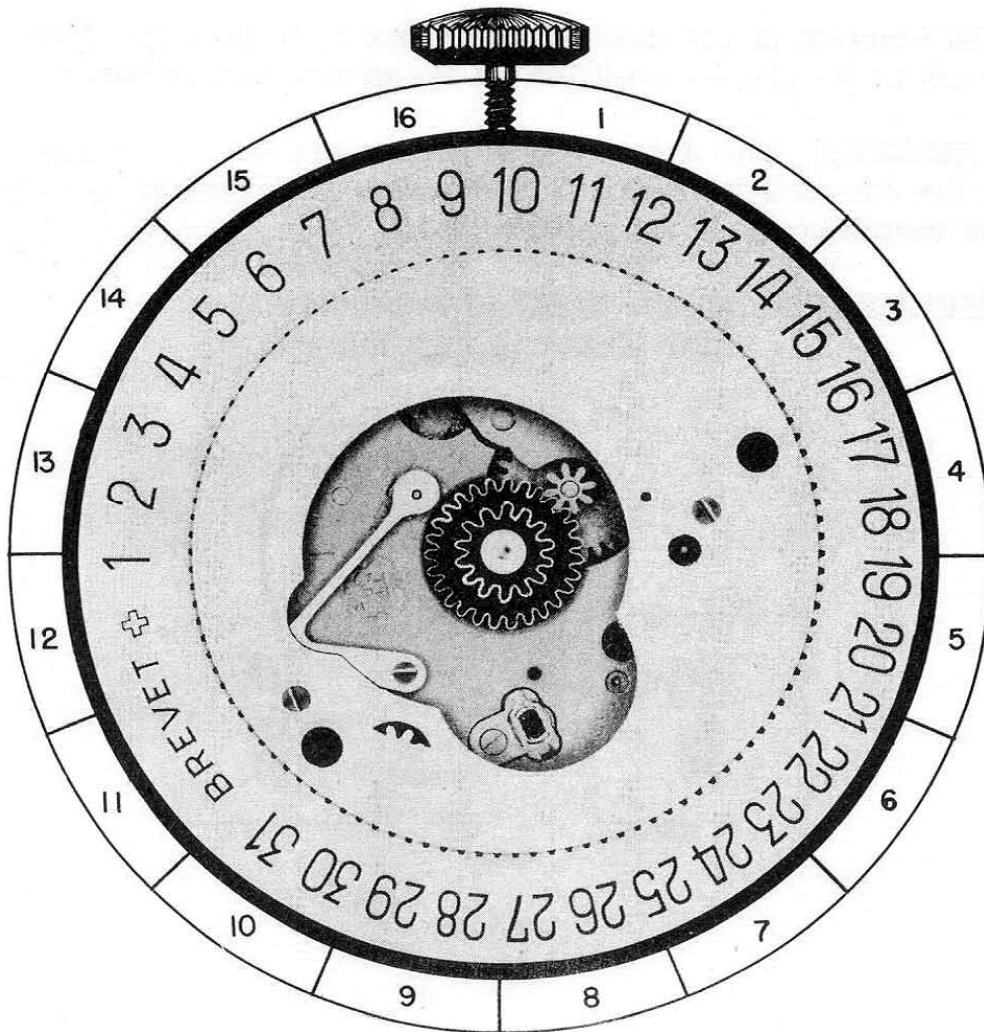

5-A

PART NO. 6

A. DISASSEMBLY PROCEDURE OF DATE TRACK BRIDGE:

This bridge is held in place by two fillister head screws FS-1 and FS-2. When these screws are removed, bridge may be lifted out of place.

(The shape of screws for this part are shown at bottom of page)

B. ASSEMBLY PROCEDURE OF DATE TRACK BRIDGE:

Place date track bridge in its proper position on plate as shown in photograph. Then replace two fillister head screws FS-1 and FS-2 that hold this bridge in place.

C. FUNCTION OF DATE TRACK BRIDGE:

The function of the date track bridge is to hold the date track in its proper position so it can function properly.

REMARKS: The date track revolves around this bridge. Also in the date track bridge is a recess. This recess is to hold the month track in its proper place.

REFERENCE: Month Track is Assembly 1.
Date Track is Assembly 7.

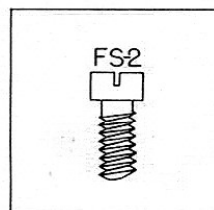
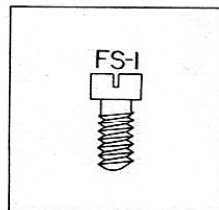

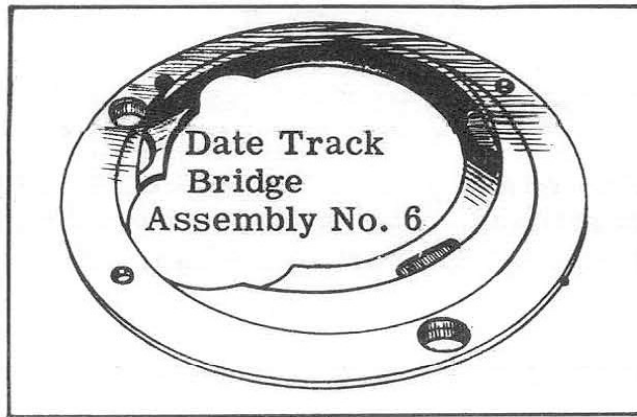

OILING

The date track bridge should not be oiled.

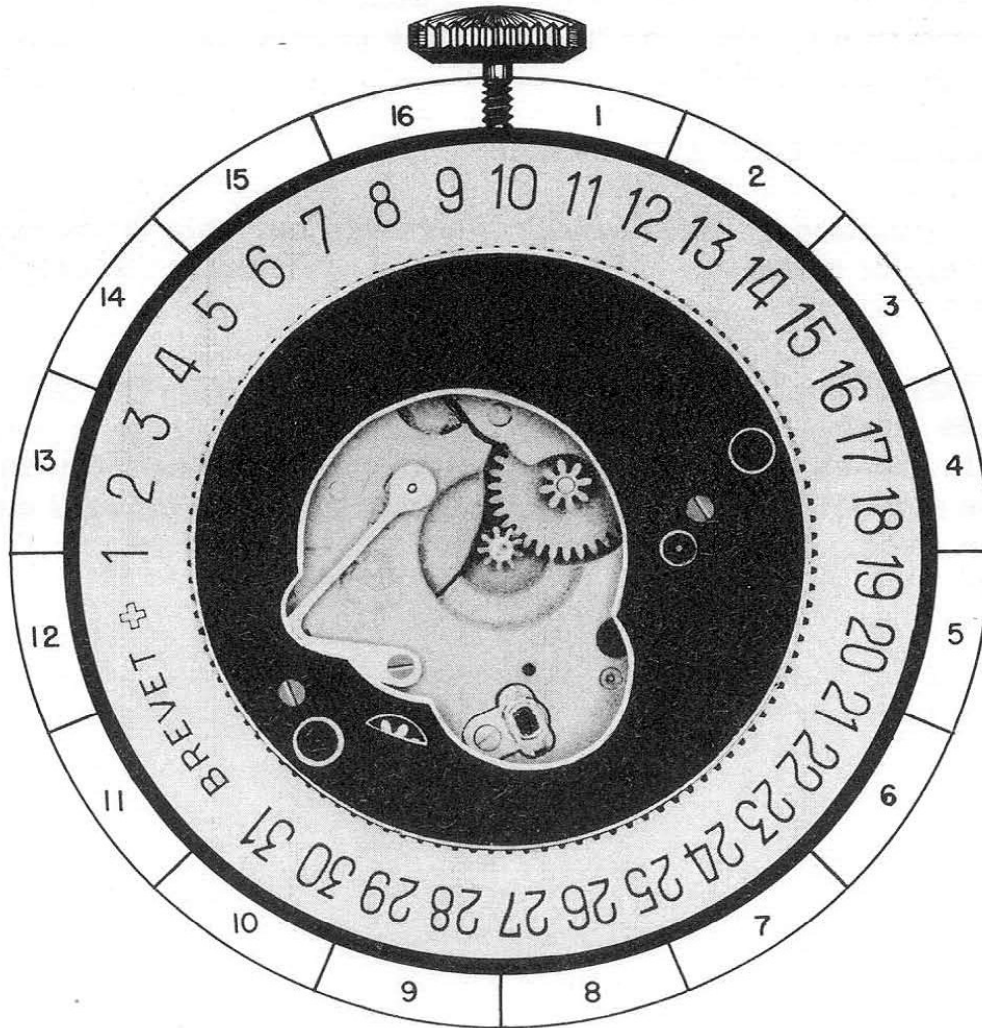

6-A

PART NO. 7

A. HAZARDS IN DISASSEMBLY OF DATE TRACK:

The numerals or face part of the date track are easily marred or scratched. The tweezers should be carefully used when handling this part to prevent marking of date track.

B. DISASSEMBLY PROCEDURE OF DATE TRACK:

The date track is lifted from the plate to remove it. The date track is held in position by the date track bridge.

C. ASSEMBLY PROCEDURE OF DATE TRACK:

Place date track in proper location on plate as shown in photograph. The date track is manually controlled to set track so the date hand indicates the correct date for the proper day of week.

D. FUNCTION OF DATE TRACK:

The function of this track is to provide movable track or circle of numerals for the date hand to indicate the proper date.

REMARKS: The date setting pinion meshes into the teeth of date track. Naturally, when the date setting pinion is turned, this causes the date track to rotate. This permits you to set the date track or the date to coincide with the correct day of the week.

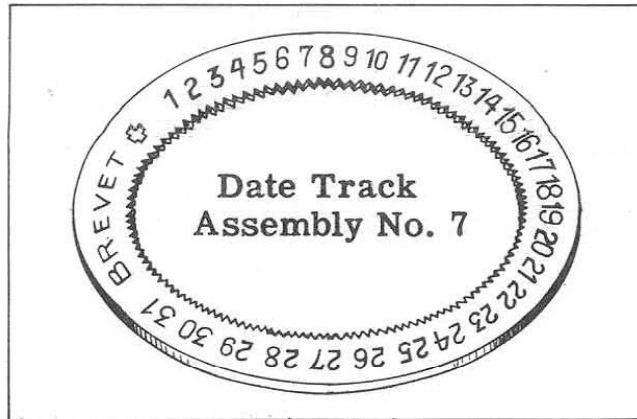

OILING

The date track should not be oiled.

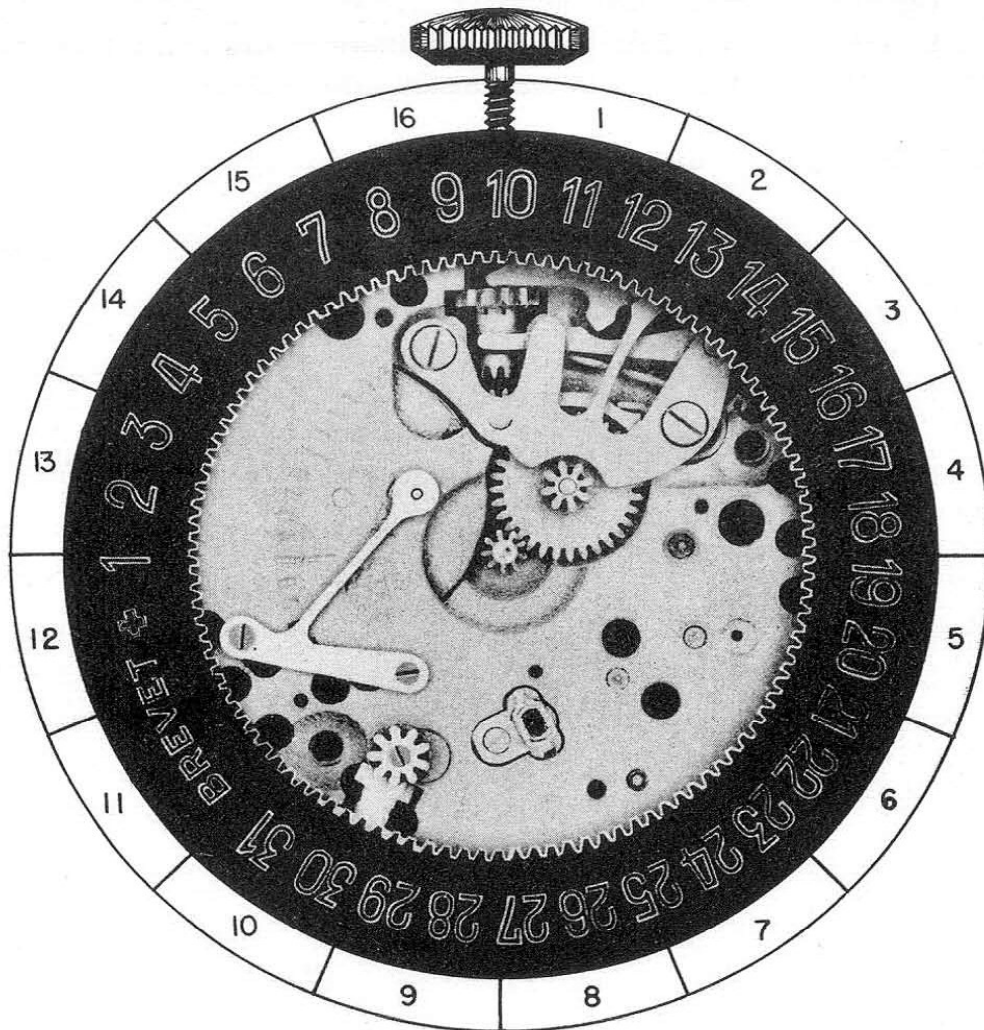

PART NO. 8

A. DISASSEMBLY PROCEDURE OF INTERMEDIATE MONTH SETTING WHEEL:

To remove this wheel, simply lift it out of place. The hole in this wheel fits over stud in plate.

B. ASSEMBLY PROCEDURE OF INTERMEDIATE MONTH SETTING WHEEL:

Place intermediate month setting wheel in its proper position on plate with hole in wheel over stud in plate.

C. FUNCTION OF INTERMEDIATE MONTH SETTING WHEEL:

Function of the intermediate month setting wheel is to transfer the power from date setting pinion to the month track. This makes it possible for you to change the month on the dial. This mechanism is manually controlled.

REFERENCE: Date setting pinion is Assembly 12.
Month track is Assembly 1.

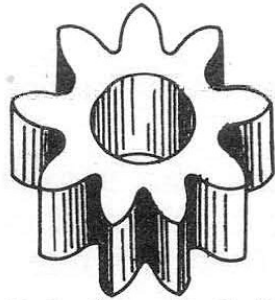

Intermediate Month Setting
Wheel Assembly No. 8

OILING

The stud screw that intermediate month setting wheel turns on should be slightly moistened with oil.

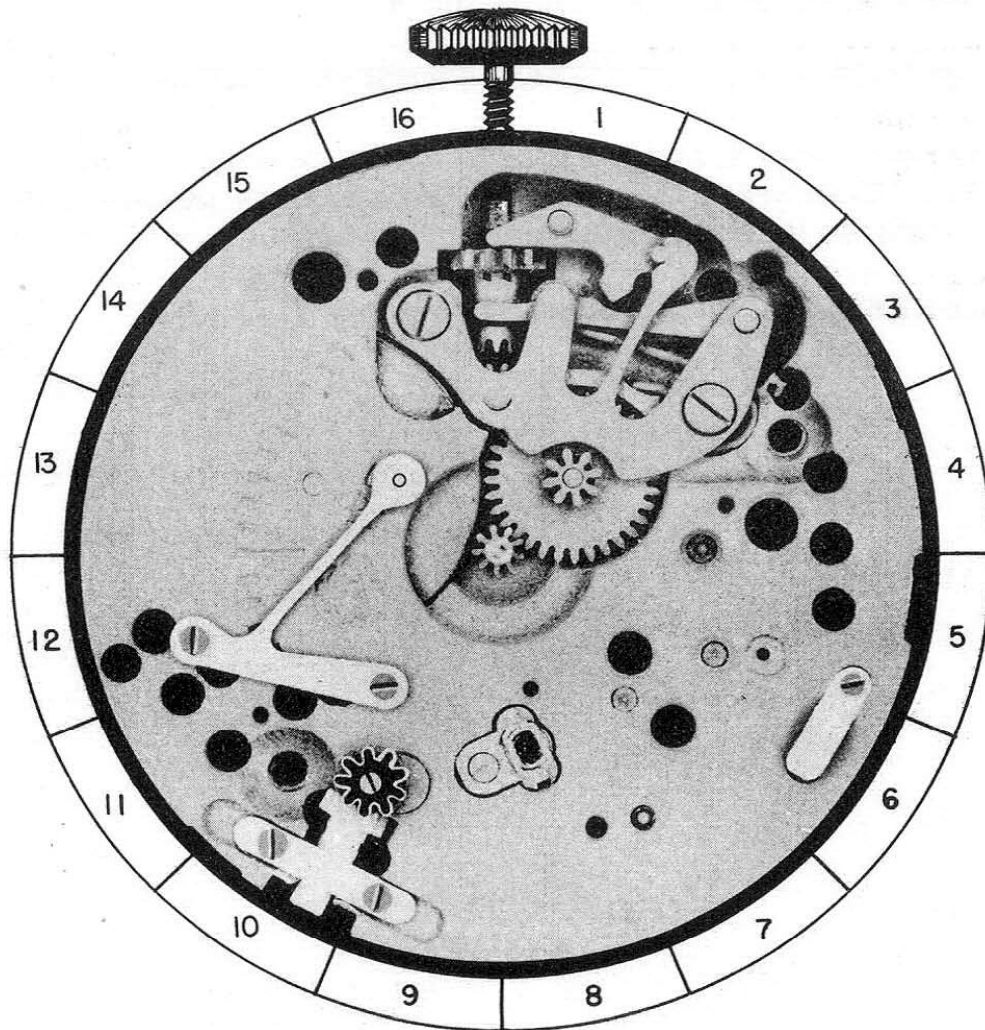

8-A

PART NO. 9

A. DISASSEMBLY PROCEDURE OF DATE TRACK TENSION SPRING:

The date track tension spring is held in place by beveled countersink screw BS-2. When this screw is removed, this spring will be free on plate and may be lifted out of place.

(The shape of screw for this part is shown at bottom of page)

B. ASSEMBLY PROCEDURE OF DATE TRACK TENSION SPRING:

Place date track tension spring in its proper position on plate as shown in photograph. The side "A" of spring must be placed up. Now replace beveled countersink screw BS-2 that holds this spring in place.

C. FUNCTION OF DATE TRACK TENSION SPRING:

The function of this spring is to hold a tension on date track. This keeps date track in a stationary position until it is moved by the date setting mechanism.

REFERENCE: Date track is Assembly 7.

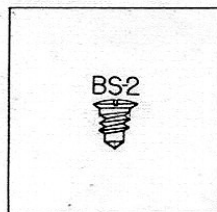

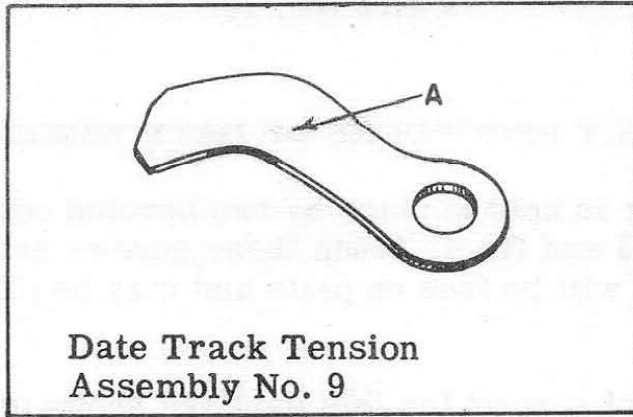

OILING

The date track tension spring should not be oiled.

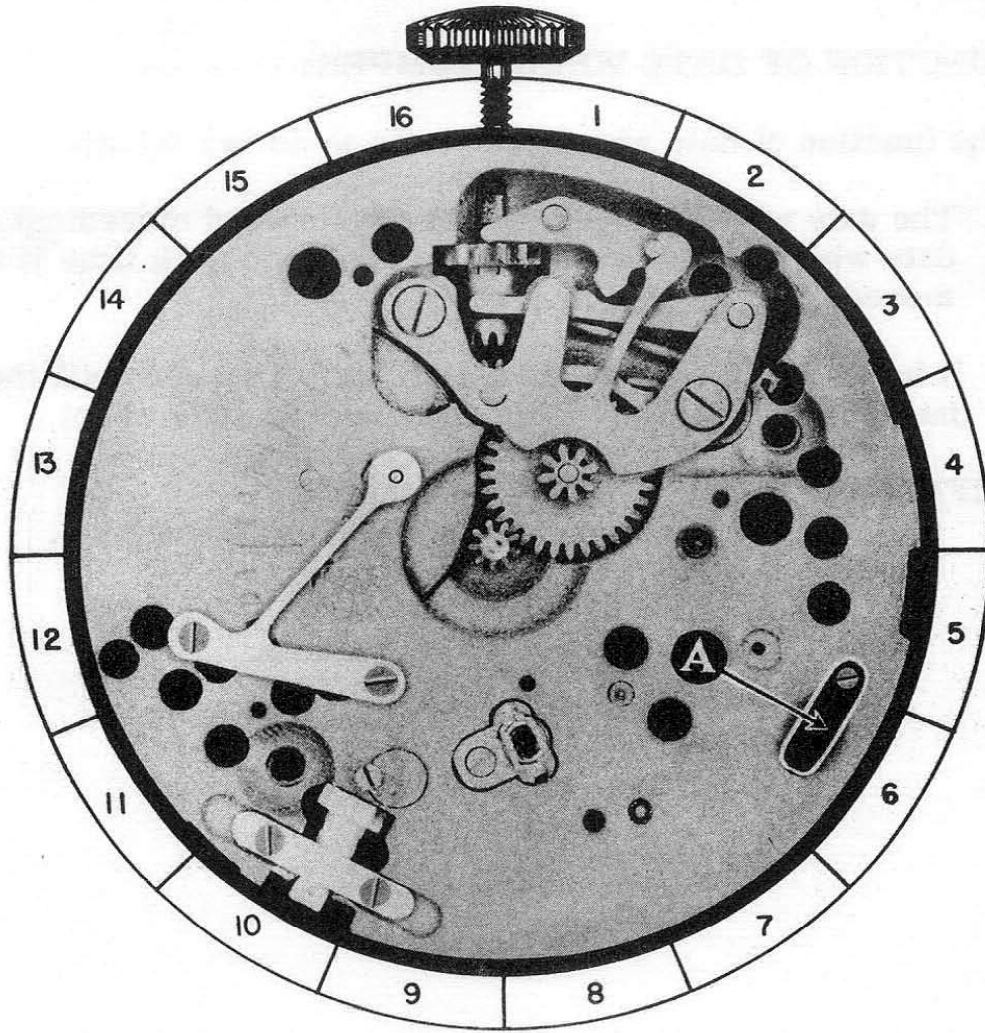

9-A

PART NO. 10

A. DISASSEMBLY PROCEDURE OF DATE WHEEL JUMPER:

This jumper is held in place by two beveled countersink screws BS-3 and BS-4. When these screws are removed, this jumper will be free on plate and may be lifted out of place.

(The shape of screws for this part are shown at bottom of page)

B. ASSEMBLY PROCEDURE OF DATE WHEEL JUMPER:

Place date wheel jumper in its proper position on plate as shown in photograph. Now replace the two beveled countersink screws BS-3 and BS-4 that hold date wheel jumper in place.

C. FUNCTION OF DATE WHEEL JUMPER:

The function of date wheel jumper is to do two things:

1. The date wheel jumper spaces the forward movement of date wheel so it moves exactly one tooth each time it is moved.
2. It holds the date wheel in a stationary position until the date wheel is moved by the intermediate date wheel.

REFERENCE: Date wheel is Assembly 2.
Intermediate date wheel is Assembly 4.

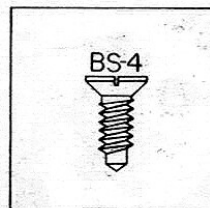
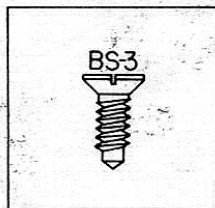

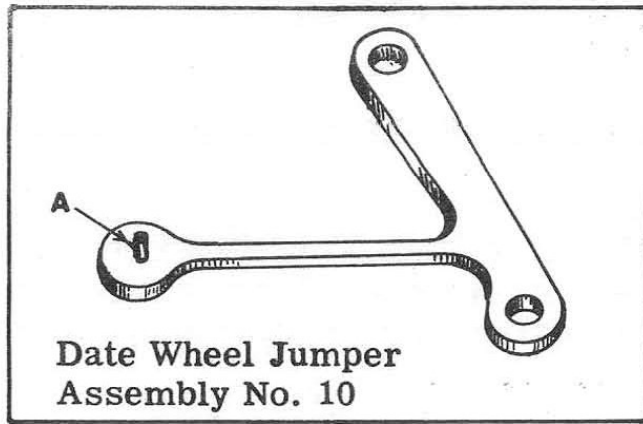

OILING

The date wheel jumper should not be oiled.

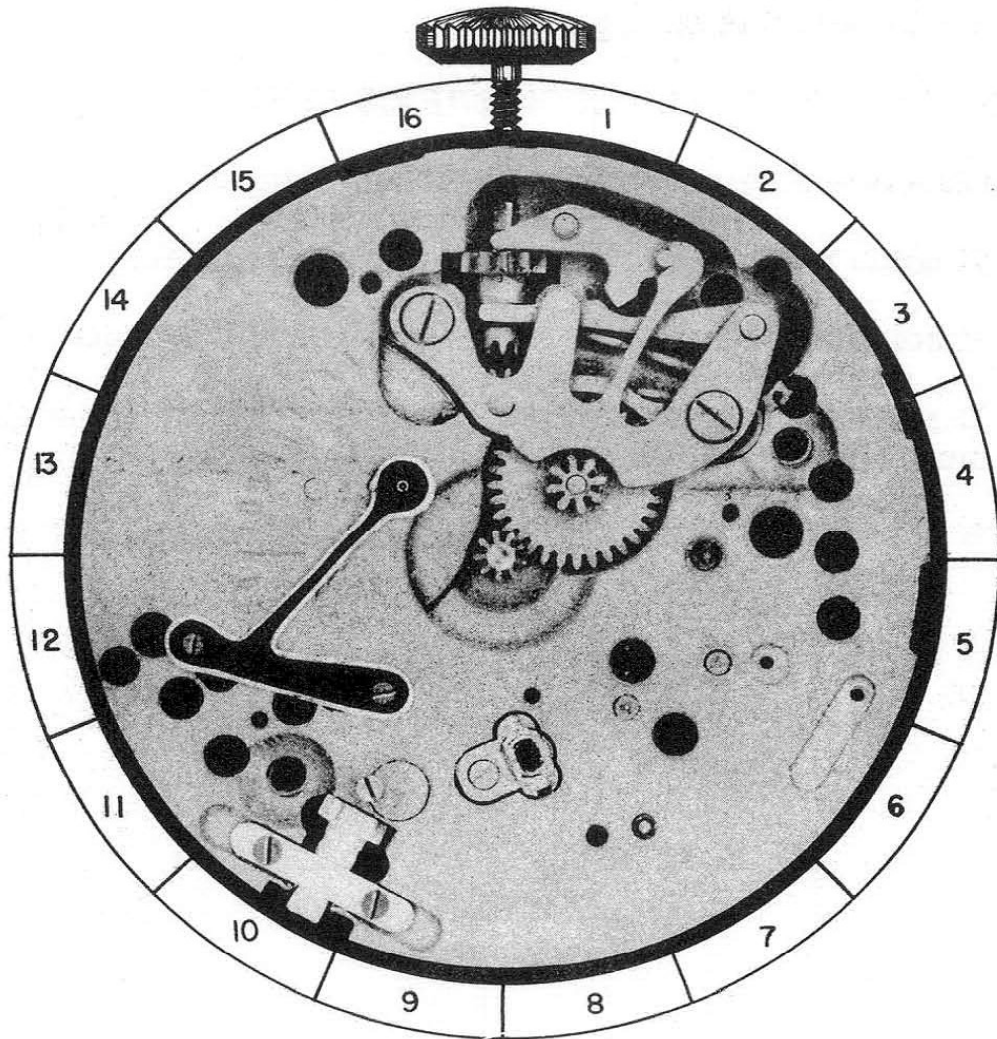

10-A

PART NO. 11

A. DISASSEMBLY PROCEDURE OF DATE PINION BRIDGE SPRING:

This spring is held in place by two beveled countersink screws BS-5 and BS-6. When these screws are removed, the spring will be free on plate and may be lifted out of place.

(The shape of screws for this part are shown at bottom of page)

B. ASSEMBLY PROCEDURE OF DATE PINION BRIDGE SPRING:

Place spring in its proper position on plate as shown in photograph. The dimple 'A' on spring should be placed down. Now replace beveled countersink screws BS-5 and BS-6 that hold this spring in place.

C. FUNCTION OF DATE PINION BRIDGE SPRING:

The function of this spring is to do four things:

1. It holds the date setting pinion in place in plate.
2. It holds the date setting pinion engaged with the date track.
3. It holds the date setting pinion engaged with the intermediate month setting wheel.
4. It holds date setting pinion in a neutral position.

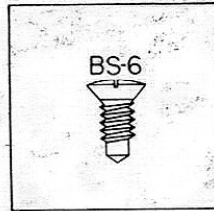
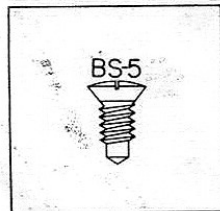

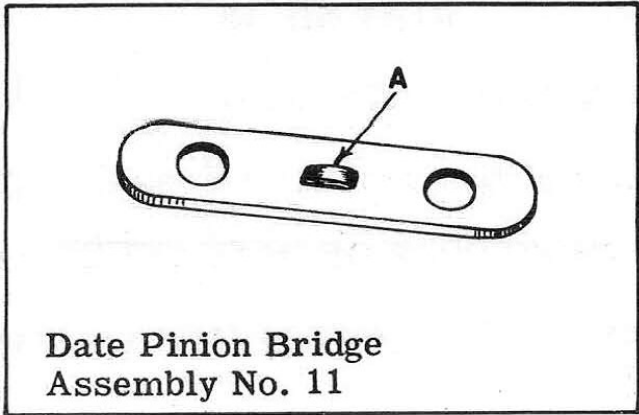

OILING

The date pinion bridge spring should not be oiled.

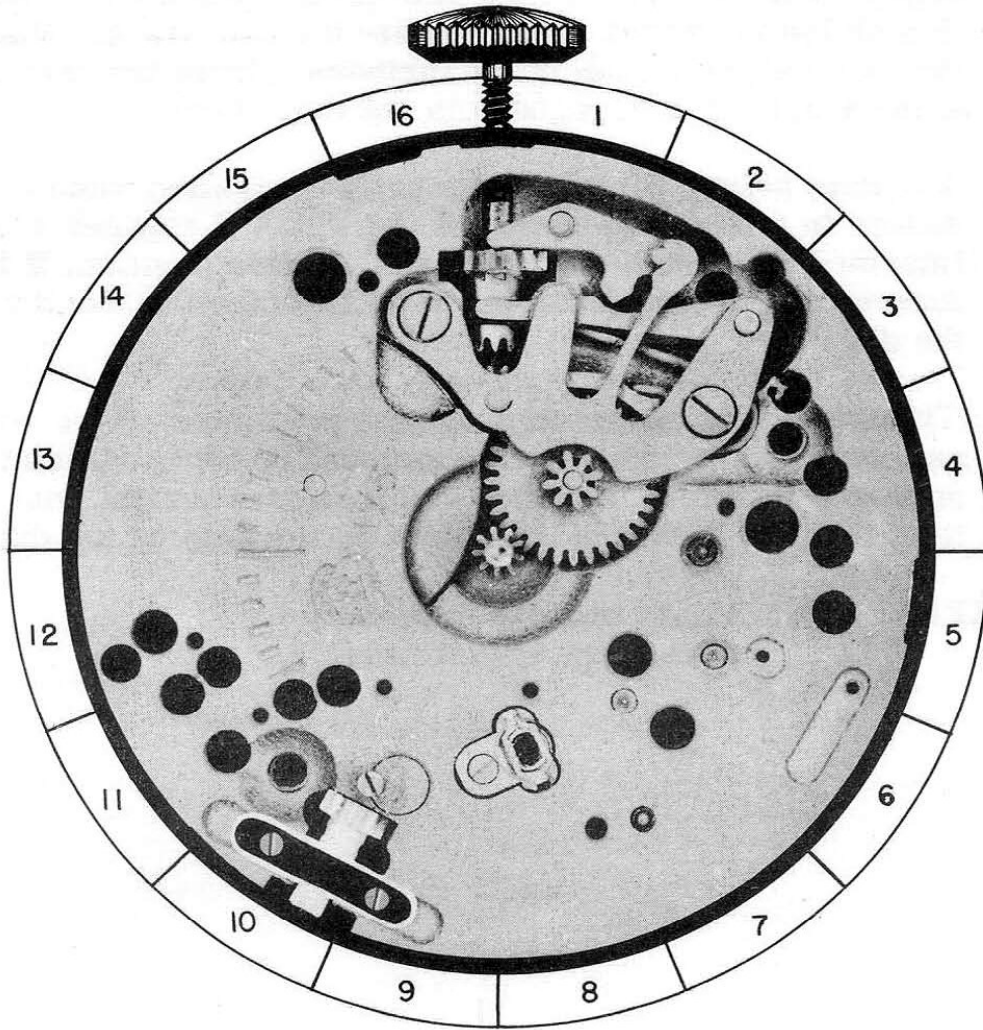

11-A

PART NO. 12

A. DISASSEMBLY PROCEDURE OF DATE SETTING PINION:

To remove this pinion, simply lift it out of place.

B. ASSEMBLY PROCEDURE OF DATE SETTING PINION:

Place date setting pinion down in recess in plate as shown in photograph.

C. FUNCTION OF DATE SETTING PINION:

The date setting pinion can be set at three different positions:

1. It can be set so that the teeth on date setting pinion engage with the teeth on the date track. Naturally, when this pinion is turned, it will rotate the date track. When the date setting pinion is the furthest from the center of the watch, it is engaged with the date track.
2. The date setting pinion is manually controlled when it is pushed in toward the center of the watch it engages with intermediate month setting wheel. In this position, if the date setting pinion is turned, it will change the months on the dial.
3. This pinion can be set at a neutral position engaged with neither of these wheels. The reason for this position is so that if the stem is turned and it is in a neutral position, it will not change the month or the date on the dial.

REFERENCE: Month track is Assembly 1.
Date track is Assembly 7.

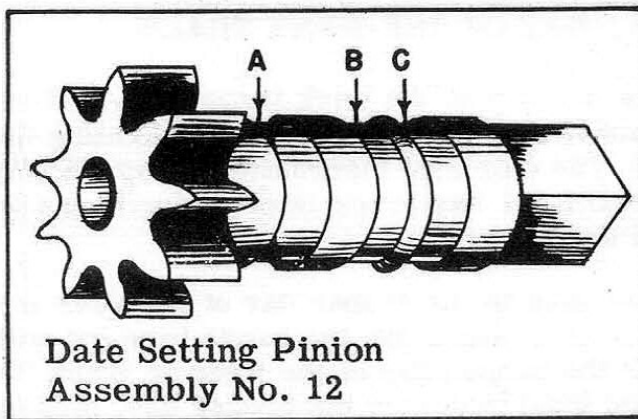

OILING

The date setting pinion should not be oiled.

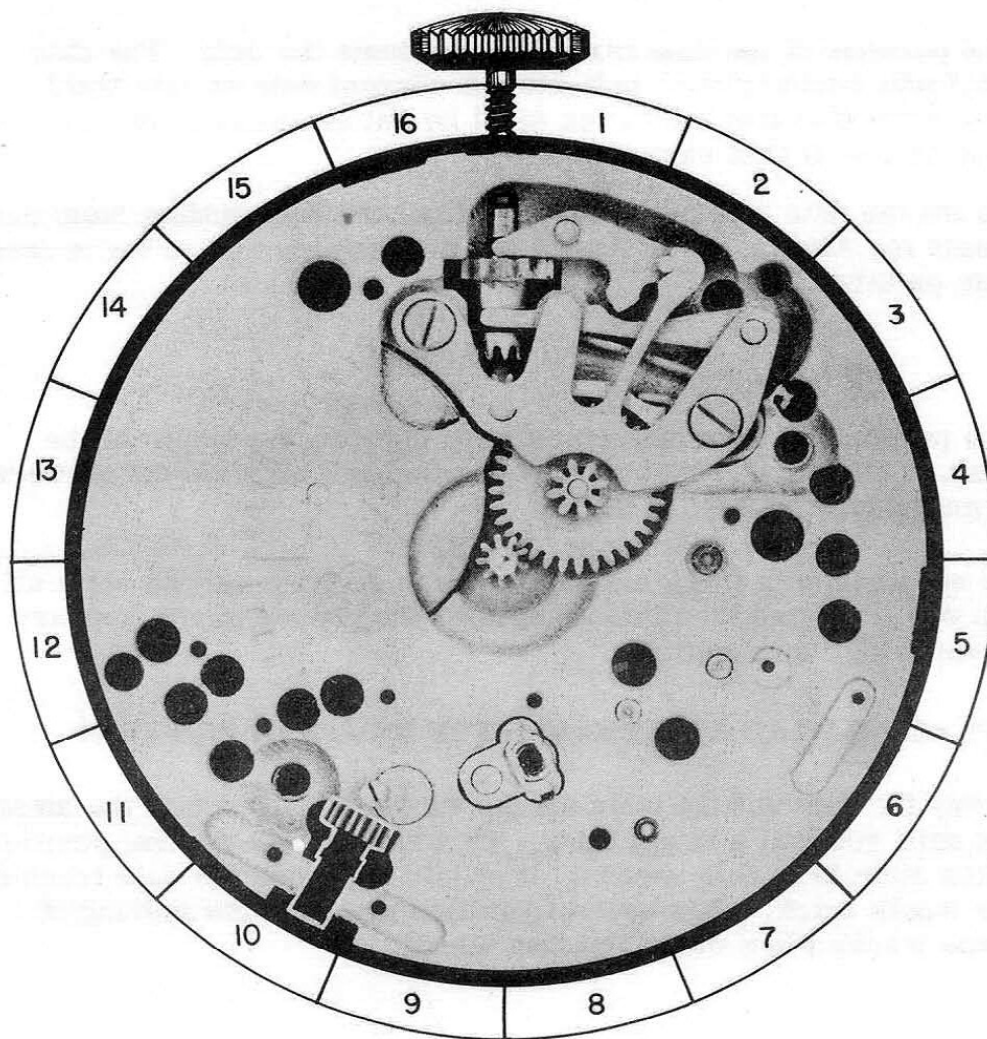

12-A

DAY OF THE WEEK TRACK

- A. The purpose of the day of the week track is to indicate the day of the week. This is done by the date hand indicating the proper day on this track. The calendar mechanism automatically turns the date hand forward one day every twenty-four hours to indicate the proper day of the week.

To set the date hand to the proper day of the week manually, pull out the winding stem and move the hands forward until the date hand indicates the proper day of the week on track "A". At the instant the date hand indicates the proper day, stop turning the winding stem and note the position of the hour hand and minute hand. They should be at 12 o'clock. This is 12 o'clock midnight. Now to set the correct time, if it is before 12 o'clock noon, just set the hands to the correct time, but if it is after 12 o'clock noon, you must first turn your winding stem until the hour hand has made one revolution. Then set the correct time.

DATE TRACK

- B. The purpose of the date track is to indicate the date. The date hand will automatically indicate the correct date on this track with exception that this track must be set manually to the correct date on the first of each month.

To set the date track manually, pull out the date setting stem and rotate the date track "B" until the date hand points to the correct date on this track.

MONTH TRACK

- C. The purpose of the month track is to indicate the month of the year. This track is manually controlled and must be set correctly on the first of each month.

To set the month track manually, press the date setting stem all the way down and turn this stem until the proper month appears at point "C" on the dial.

PLACING DATE SETTING STEM IN NEUTRAL POSITION

Press the date setting stem all the way down. Now pull the stem out until you feel a slight click. This should be a neutral position. When stem is in this position, it should not move the date track or the month track. This neutral position prevents the moving of these tracks when watch is being worn.

